

तमसो मा ज्योतिर्गमय

SANTINIKETAN  
VISWA BHARATI  
LIBRARY

505

C. S

V. 2













# Current Science

Vol. XXVII]

JANUARY 1958

[No. 1

## CONTENTS

	PAGE
<i>High Resolution Raman Spectroscopy and the Structure of Simple Molecules</i> —B. P. STOICHEFF .. .. .	1
<i>The Indian Academy of Sciences</i> .. .. .	9
<i>Some Recent Soviet Work on Crystal Physics</i> —R. F. S. HEARMON ..	10
<i>Lightning Shock</i> .. .. .	12
<i>Eleventh General Assembly of International Union of Geodesy and Geophysics</i> —U. ASWATHANARAYANA .. .. .	13
<i>Preparation of Nobelium</i> .. .. .	14
<i>A Preliminary Report on the Detection of Isopropyl-Noradrenaline in Human Urine</i> —SARADA SUBRAHMANYAM .. .. .	15
<i>Accident at Windscale</i> .. .. .	17
<i>Letters to the Editor</i>	
<i>Anodic Reactions in the Electrolysis of Acid-Cobalt-Fluoride</i> —A. N. KAPPANNA AND E. R. TALATY .. .. .	18
<i>A Compensated Moving Cylinder Viscometer</i> —GOPALA MENON SREEKANTATH AND C. A. VERGHESE .. .. .	18
<i>Kostanecki-Robinson Phenylacetylation of Orcacetophenone and Orcopropiophenone</i> —C. B. THANAWALLA AND P. L. TRIVEDI .. .. .	20
<i>Separation of Haemoglobin Components on Paper with the Aid of a pH Gradient</i> —A Preliminary Report—N. P. JAIN .. .. .	20
<i>Oxidative Decarboxylation of Some Alpha-Hydroxy Acids with Silver Iodide Dibenzoate</i> —P. S. RAMAN ..	22
<i>A Note on Pyrolysis and Ignition of Wood</i> —D. NARAYANAMURTI AND JOSEPH GEORGE .. .. .	22
<i>Patterns of Regeneration in Notothylas indica Kashyap</i> —RAM UDAR AND V. B. SINGH .. .. .	23
<i>Note on Dielectric Breakdown Strength of Wood and Modified Wood</i> —B. N. PRASAD .. .. .	25
<i>What Constitutes a 'Network' in Mammalian Neurones?</i> —S. K. MALHOTRA ..	27
<i>The Reaction of the Vacuole and the Nucleus of Living Yeast to Neutral Red</i> —T. R. THYAGARAJAN .. .. .	28
<i>Root-Inducing Substance in Groundnut Seeds</i> —S. S. NAGARAJAN AND S. GOPALAKRISHNAN .. .. .	29
<i>Bacterial Leaf-Spot of Pennisetum typhoides</i> —C. K. SOWMINI RAJAGOPALAN AND G. RANGASWAMI .. .. .	30
<i>The Coffee Leaf-Miner, Agromyza (Melanagromyza) coffeae Hering (Diptera: Agromyzidae)</i> —C. K. VASUDEVAN .. .. .	31
<i>Experimental Induction of Leaf Heteromorphism in Sesamum indicum L.</i> —S. C. CHAKRAVARTI AND B. K. ARORA ..	32
<i>Reviews</i> .. .. .	33
<i>Science Notes and News</i> .. .. .	38



# PANJAB UNIVERSITY

*Applications are invited for the following posts:—*

(I) **Two Readers in Physics:** Grade Rs. 500-30-800 (*plus* allowances admissible under University rules) with benefit of Provident Fund on confirmation. *Qualifications:* (i) Distinguished academic record preferably Doctorate in Physics with published research work of merit and experience of Post-Graduate teaching, (ii) Specialisation either in Nuclear Physics and Cosmic Rays or Electronics and Micro-waves. The Readers will be required to undertake research, lecture to post-graduate students and guide them in research.

(II) **Senior Lecturer in Mathematical Physics:** Grade Rs. 300-25-650 (*plus* allowances admissible under University rules) with benefit of Provident Fund on confirmation. *Qualifications:* First Class M.Sc. in Physics and a Doctorate Degree in Theoretical Physics with research work in Quantum Mechanics. Experience of teaching Mathematics related to physical problem desirable.

Applications stating age, present position and pay, academic qualifications, teaching and research experience, names of two referees in the field, with copies of research publications and attested copies of certificates and testimonials should reach **Shri J. R. Agnihotri, Registrar, P.U., Chandigarh-3, by the 15th March 1958.**

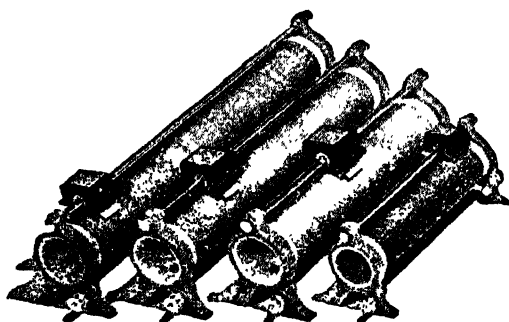

## 'STANDARD' RHEOSTATS

SINGLE, DOUBLE & FOUR-TUBE

COVER A WIDE RANGE  
FOR USE IN  
COLLEGE LABORATORIES &  
INDUSTRIAL WORKSHOPS

**THE STANDARD SCIENTIFIC  
INSTRUMENTS CO.**

115, BRODIES ROAD, MADRAS 28

## SPECTROSCOPIC EQUIPMENT AND ACCESSORIES

FOR  
QUANTITATIVE ANALYSIS & RESEARCH WORK

Light sources like Arc Lamps with universal movements, precision slits, mountings for spectrographs, cameras, micro-photometers, etc., etc.

*Entirely Our Manufacture*

*For full particulars, please write to:*

**THE GENERAL  
ENGINEERING AND SCIENTIFIC CO.**  
WALTAIR, VISAKHAPATNAM-3  
(S. INDIA)

• GRAMS: "ELECTRONIC"

*Technical Adviser:*

**Dr. I. RAMAKRISHNA RAO**  
M.A., Ph.D. (Cal.), D.Sc. (Lond.)

# Current Science

Vol. XXVII]

FEBRUARY 1958

[No. 2

## CONTENTS

	PAGE
<i>Microwave Absorption in Solids</i> —A. JAYARAMAN .. .. .	41
<i>Indian Science Congress</i> .. .. .	45
<i>The Crystal Structure of L-Tyrosine Hydrobromide</i> —R. SRINIVASAN .. .. .	46
<i>Marine Biological Station, Porto Novo (S. India)</i> .. .. .	48
<i>Moulds, Metabolites and Tissues</i> .. .. .	49
<i>A Geochemical Hypothesis of the Earth's Structure</i> .. .. .	50
<i>Letters to the Editor</i>	
<i>A New Method for the Separation of Sols from Sol-Mixtures</i> —K. KRISHNAMURTI AND B. V. DHARESHWAR .. .. .	51
<i>Lattice Parameters and Crystallographic Angles of Hexagonal Cobalt</i> —T. R. ANANTHARAMAN .. .. .	51
<i>Heat of Wetting of Charcoal in Relation to Chemisorbed Oxygen</i> —BALWANT RAI PURI, D. D. SINGH AND LEKH RAJ SHARMA .. .. .	53
<i>A Water Gap of an Unusual Origin Across Archæan-Cuddapah Boundary</i> —R. VAIDYANADHAN .. .. .	54
<i>A Note on Partial Parthenocarpy in the Genus Luffa</i> —S. N. SINGH .. .. .	54
<i>A Note on the Food and Feeding Habits of Clupisoma garua (Hamilton), and Eutropiichthys vacha (Hamilton) from Allahabad (U.P.)</i> —M. P. MOTWANI AND S. J. KARAMCHANDANI .. .. .	55
<i>Cytochemical Studies on the Oocytes of the Termite Queen Odontotermes redemanni (Wasmann)</i> —BARUNDEB BANERJEE .. .. .	56
<i>Pelagic Tunicates as Indicators of Water Movements off Waltair Coast</i> —P. N. GANAPATI AND P. V. BHAVANARAYANA .. .. .	57
<i>Occurrence of Artemia salina in Sambhar Lake, Rajasthan</i> —INDERCHAND BAID .. .. .	58
<i>The Occurrence and Inheritance of Telespic Leaf-Sheaths in Sorghum</i> —C. SREERAMULU .. .. .	59
<i>Cytology of Isœtes</i> —A. ABRAHAM AND C. A. NINAN .. .. .	60
<i>Effect of Mowing Grass on the Concentrations of Certain Constituents of the Air Spora</i> —T. SREERAMULU .. .. .	61
<i>X-Ray Induced Somatic Haploidy in Watermelon</i> —M. S. SWAMINATHAN AND M. P. SINGH .. .. .	63
<i>Effects of Maleic Hydrazide on an Early Variety of Rice</i> —G. MISRA AND G. SAHU .. .. .	64
<i>Stomatal Types in Centrospermae</i> —SUBIR SEN .. .. .	65
<i>Tip-Rot of Mesta (Hibiscus cannabinus Linn.)</i> —T. GHOSH AND N. MUKHERJI .. .. .	67
<i>Molybdenum Content of a Few Forage Plants of Western India</i> —(MISS) JAYA G. IYER AND Y. SATYANARAYAN .. .. .	69
<i>Reviews</i> .. .. .	70
<i>Science Notes and News</i> .. .. .	76

## THE PALAEOBOTANIST

A JOURNAL DEVOTED TO  
PALAEOBOTANICAL RESEARCH

(Published by the Birbal Sahni Institute of  
Palaeobotany, Lucknow)

Volume 5, No. 2 of the Journal has now been published (Price Rs. 15/- or £ 1.4 s. or \$ 3.40). A few copies of Volume I (Birbal Sahni Memorial Volume), II, III, IV & V No. 1, are also available (Price Rs. 50/- or \$ 11.00 and Rs. 20/- or \$ 4.30 and Rs. 30/- or \$ 6.60 or £ 2.7 s. and Rs. 15/- or £ 1.4 s. or \$ 3.40, respectively). The prices are inclusive of postage. Copies of the volumes can be obtained on payment of the above cost in advance from the Registrar, Birbal Sahni Institute of Palaeobotany, 53, University Road, Lucknow (India).

## OMEGA INSTRUMENTS CO. CALCUTTA

Manufacture—

LABORATORY OVENS with thermostatic control of all sizes for various temperature ranges, with and without fan circulation.

THERMOSTATIC BATHS

NULL POINT DETECTOR

LABORATORY OSCILLATOR

LABORATORY CIRCULATION PUMPS

SERUM INSPISSATORS

INCUBATORS

PILOT PLANTS FOR INDUSTRY

*Please send enquiries to the Sole Selling Agent's*

**KINLAB (PRIVATE) LTD.**

**5, Marquis Street**

**CALCUTTA 16**



**RESISTANCE  
BOXES**

ARE GUARANTEED\* TO HAVE A  
LASTING ACCURACY OF 0.1% WITH USE.  
CONTACTS ARE DESIGNED WITH  
THIS REQUIREMENT IN VIEW.

*Manufactured by:*

**THE STANDARD  
SCIENTIFIC INSTRUMENTS CO.  
115, BRODIES ROAD, MADRAS 28**

## SPECTROSCOPIC EQUIPMENT AND ACCESSORIES

FOR  
QUANTITATIVE ANALYSIS & RESEARCH WORK

Light sources like Arc Lamps with universal movements, precision slits, mountings for spectrographs, cameras, microphotometers, etc., etc.

*Entirely Our Manufacture*

*For full particulars, please write to :*

**THE GENERAL  
ENGINEERING AND SCIENTIFIC CO.**

**WALTAIR VISAKHAPATNAM-3  
(S. INDIA)**

**GRAMS: "ELECTRONIC"**

*Technical Adviser :*

**Dr. I. RAMAKRISHNA RAO  
M.A., Ph.D. (Cal.), D.Sc. (Lond.)**

# Current Science

Vol. XXVII]

MARCH 1958

[No. 3

## CONTENTS

	PAGE
Quantum Physics and Philosophy—ALFRED LANDÉ .. .. .	81
Conservation of Parity Law Tested on Free Neutrons .. .. .	85
The Indian Society of Theoretical and Applied Mechanics—Third Congress on Theoretical and Applied Mechanics .. .. .	86
Tracer Atoms in the Study of Plant Life—ACADEMICIAN A. L. KURSANOV .. .. .	87
Chemical Control of the Rice Stem-borer ( <i>Schoenobius incertulas</i> Wlk.)— D. V. MURTHY AND M. Q. KHAN .. .. .	89
The British Association for the Advancement of Science .. .. .	91
Controlled Release of Thermonuclear Energy .. .. .	92

### Letters to the Editor

<i>Temperature Dependence of Ultrasonic Absorption in MnSO<sub>4</sub> Solution</i> —SUSHIL KUMAR KOR .. .. .	94	<i>Studies in the Entomogenous Fungus, Metarrhizium anisopliæ (Metsch.) Sorok.</i> —(MISS) AHILYA P. JAGTAP .. .. .	99
<i>Study on the Separation of Thorium and Uranium (VI) by Ion-Exchange</i> —(MRS.) N. S. KUNTE AND D. SEN .. .. .	94	<i>A Marker Gene for Red Gram (Cajanus cajan, Millsp.)</i> —K. DIVAKARAN AND G. RAMABHADRAN .. .. .	100
<i>Measurement of Electrical Resistivity by the Ballistic Method</i> —K. G. RAMANATHAN, J. S. DHILLON AND K. D. BAVEJA .. .. .	95	<i>Variations in the Haploid Chromosome Number of Corchorus sidoides F. Muell (Family: Tiliaceæ)</i> —SAMBHU LALL BASAK .. .. .	101
<i>Zircons from Granites of Mysore</i> —A. ACHUTA RAO .. .. .	96	<i>The Effect of Thyroxine on Phosphatase, Ascorbic Acid and Tocopherol Content in the Blood and Milk of the Cow and the Buffalo</i> —R. CHANDA .. .. .	102
<i>A Leaf-Spot Disease of Echinochloa colonum Link due to Piricularia Species</i> —O. P. SHARMA AND J. L. MERH .. .. .	96	<i>In vitro Growth of Ovaries of Linaria maroccana Hook.</i> —R. C. SACHAR AND B. BALDEV .. .. .	104
<i>A Note on the Specific Heat of Wood</i> —D. NARAYANAMURTI AND N. C. JAIN .. .. .	97	<i>Embryology of Aerva tomentosa Forsk.</i> —R. C. SACHAR AND PREM MURGAI .. .. .	105
<i>Cytological Studies on Spermatogenesis of Eypreocnemis Sp.</i> —NIRMALA CHATTERJEE .. .. .	98	<i>A New Species of the Genus Pallisentis (Acanthocephala)</i> —S. C. AGARWAL .. .. .	107
<i>Salinity Tolerance of Etroplus maculatus (Block)</i> —KANDULA PAMPAPATHI RAO .. .. .	99		
<i>Reviews</i> .. .. .	108		
<i>Science Notes and News</i> .. .. .	115		

## PANJAB UNIVERSITY

Applications are invited for the post of Professor of Geography. Grade Rs. 800-50-1250 plus Dearness Allowance, as admissible, with benefit of Provident Fund on confirmation. Qualifications : (a) Brilliant academic career followed by outstanding research work, preferably with a Doctorate Degree. (b) Eminence in some field of Geography. (c) Competence to guide research. (d) Teaching experience of about 10 years preferably with post-graduate classes. Experience of administration will be an additional qualification.

Applications should reach Shri J. R. Agnihotri, Registrar, P. U., Chandigarh, by the 30th April, 1958, stating age, present position and pay, academic qualifications, teaching and research experience, names of two referees in the field, with copies of research publications and attested copies of University certificates and testimonials.

### BALANCES FOR RESEARCH & ROUTINE WORK



Catalogues sent on request

*Manufactured by:*

**SCIENTIFIC INDUSTRIES (India)**

**34, Banerji Bagan Lane, SALKIA (Howrah)**

# Current Science

Vol. XXVII]

APRIL 1958

[No. 4

## CONTENTS

	PAGE
<i>The Quantum Hyper-Frequency Amplifier—The Maser—A. JAYARAMAN</i> ..	117
<i>Max Planck</i> .. .. .	121
<i>New Type of Reflexes</i> .. .. .	122
<i>The Chemistry of Nucleic Acids—T. P. SESHADRI</i> .. .. .	123
<i>Symposium on the Monsoons of the World—P. R. P.</i> .. .. .	129
<i>A Remarkable Solar Radio Event</i> .. .. .	129
<i>Obituary: Professor M. Damodaran—K. RAMAMURTI</i> .. .. .	130
<i>The Properties of Thrombinogen</i> .. .. .	130

### Letters to the Editor

<i>An Empirical Formula for the Masses of the Elementary Particles—LEONARD S. LEVIIT</i> .. .. .	131	<i>Stegana lateralis V.D. Wulp as a Pest of Sesbania grandiflora—T. R. SUBRAMANIAN AND K. R. NAGARAJA RAO</i> ..	138
<i>Determination of Blood Meals of Indian Culicoides (Ceratopogonidae: Diptera)—P. SEN AND S. K. DAS GUPTA</i> ..	132	<i>On the Antheridium in Characeae—V. S. SUNDARALINGAM AND K. J. FRANCIS</i>	138
<i>Apparent Molar Volumes and Aggregation of Barbiturates—V. R. KRISHNAN</i>	132	<i>Chromosome Numbers of Some Dicotyledons—R. P. PATIL</i> .. .. .	140
<i>Presence of Propolis in the Prothoracic Spiracles of Apis florea Fab.—G. T. TONAPI</i> .. .. .	133	<i>Lateral Bud Development in 'Pearl Millet'—Pennisetum typhoides Stapf et Hubbard, in Relation to Its Flowering—K. K. NANDA AND J. J. CHINYOY</i> ..	141
<i>The Regulation of Petal Number—SUBODH KUMAR ROY</i> .. .. .	134	<i>The Study of Seed Content and Fruit Shape in Relation to Removal of Stigma in Luffa Species—S. N. SINGH</i> ..	143
<i>Periodicity of Wuchereria Microfilariae in Human Blood—P. SEN</i> .. .. .	135	<i>Primitive Features in the Alimentary Canal of Gadusia chapra (Hamilton)—P. N. SRIVASTAVA</i> .. .. .	144
<i>On Sal Wood Excavated from Mauryan Pillared Hall, Pataliputra—S. S. GHOSH AND KRISHNA LAL</i> .. .. .	136	<i>Roots on an Internode in Sugarcane—T. A. DAVIS</i> .. .. .	145
<i>Xyleborus discolor Bland., as a Pest of Cacao—I. P. JANAKI, T. S. MUTHUKRISHNAN AND K. R. NAGARAJA RAO</i> ..	138	<i>Cytology of Diplaziopsis javanica—S. S. BIR</i> .. .. .	146

Reviews .. .. . 147

Science Notes and News .. 153



**CALIBRATED SHUNTS**

For Potentiometer Work

ACCURACY 0.1 PER CENT.  
WOUND OF MINALPHA WIRE  
WITH  
CURRENT & POTENTIAL TERMINALS

Made by:

**THE STANDARD SCIENTIFIC  
INSTRUMENTS Co.**

115, BRODIES ROAD, MADRAS 28

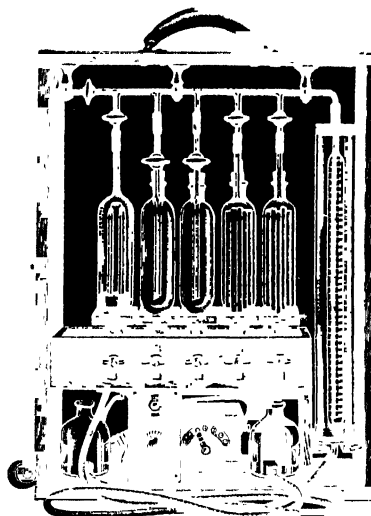

**Associated Scientific Corporation**

Manufacturers and Dealers in  
SCIENTIFIC GLASS APPARATUS AND  
EQUIPMENTS

232 B, UPPER CIRCULAR ROAD

**CALCUTTA-4**

GRAM : ASCINCORP

# AVAIL OF OUR EXPERT SERVICES

In servicing, repairing and designing your Electrical and  
Electronic Equipment such as :

pH Meters, Photometers, Conductivity Bridges,  
Cardiographs, H.F. Equipment, Diathermy  
Units, Induction Heating Devices, etc., etc.

We have been doing this for various Firms<sup>s</sup> and Government  
Departments for over 15 years past

*A TRIAL WILL SATISFY YOU*

**RADIO ELECTRIC LTD.**

2B, LAMINGTON CHAMBERS, LAMINGTON ROAD

**BOMBAY 4**

# Current Science

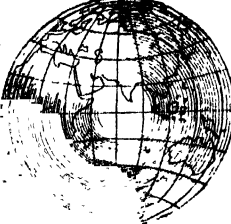

Vol. XXVII]

MAY 1958

[No. 5

## CONTENTS

	PAGE
<i>Applications of Ultrasonic Vibrations</i> —E. G. RICHARDSON .. ..	155
<i>Rocket-Firing Contribution to Geophysical Year</i> .. ..	159
<i>Effect of Terrestrial Magnetic Field on Cosmic Radiation</i> .. ..	160
<i>Limiting Polarization Curves for Radio Wave Propagation in the Ionosphere</i> —R. N. SINGH AND Y. S. N. MURTY .. ..	161
<i>Lipoprotein Cholesterol in Coronary Disease and Anæmia</i> —PARAMJIT R. PABRAI AND K. B. SEHRA .. ..	163
<i>Virus Research</i> —T. S. SADASIVAN .. ..	165
<i>USSR Academy of Sciences Discuss Data from Sputniks Experiment with a Dog</i> .. ..	166
<i>Letters to the Editor</i>	
<i>Growth Spirals on Electrodeposited Silver</i> —V. G. BHIDE AND W. G. NAFDE .. ..	167
<i>The Reduction of Thorium at the Dropping Mercury Electrode</i> —T. P. SARMA AND BH. S. V. RAGHAVA RAO .. ..	167
<i>Chemical Examination of Aristolochia bracteata Retz.</i> —K. V. JAGANNADHA RAO, L. RAMACHANDRA ROW AND Y. SURYANARAYANA MURTY .. ..	168
<i>Petrological Investigations of the Rocks of Mohand Near Dehra Dun</i> —S. K. BABU AND P. V. DEHADRAI .. ..	168
<i>γ-Substitution in Resorcinol Dimethyl Ether</i> —SHRIMATI H. R. JAYAMMA, A. R. INAMDAR AND K. S. NARGUND .. ..	170
<i>Cellulose Decomposition by Species of Nocardia</i> —YVONNE M. FREITAS AND J. V. BHAT .. ..	171
<i>Studies on the Structure and Physiology of the Flight Muscles of Birds. 3. Alkaline Phosphatase Activity in the Pigeon Breast Muscle</i> —J. C. GEORGE, S. MADHAVAN NAIR AND K. S. SCARIA .. ..	172
<i>The Subcommissural Organ in the Garden Lizard Calotes versicolor</i> —K. R. PANDALAI .. ..	173
<i>Nuclear Differentiation in Binucleate Pollen Mother Cells</i> —H. K. JAIN .. ..	174
<i>The Fungistatic and Fungicidal Action of Mycostatin on Deightonella torulosum</i> —G. RANGASWAMI AND (MISS) A. P. SAROJANI DAMODARAN .. ..	176
<i>Cytology of Fern Genus Acrophorus</i> —S. C. VERMA .. ..	177
<i>Note on Goniozus Sp. (Bethyridæ—Hymenoptera) Parasite of Stem and Root-Borers of Sugarcane in Bihar</i> —A. R. PRASAD AND S. MOHAMMAD ALI .. ..	178
<i>The Effect of Certain Insecticides on the Larvæ of Anomis sabulifera Guenther</i> —R. N. GANGULI .. ..	179
<i>A Technique for Isolating Pathogenic Cultures of Pythium from the Soil</i> —K. V. SRINIVASAN .. ..	180
<i>Male Sterility in Crotalaria striata</i> —C. KEMPANNA AND K. S. KRISHNA SASTRY .. ..	181
<i>Observations on the Seaward Migration of Mugil cephalus Linnæus from the Chilka Lake for Breeding</i> —V. G. JHINGRAN .. ..	181
<i>Note on Hymenia fascialis C., A Pest of Sugarbeet</i> —DHAMO K. BUTANI .. ..	182
<i>Inheritance of the Tiny-Leaved and Alternifolia Forms in Cicer arietinum L.</i> —G. P. ARGIKAR .. ..	183
<i>Tracheal Concentration in the Abdomen of Two Species of Coleoptera</i> —G. T. TONAPI .. ..	184
<i>Reviews</i> .. ..	186
<i>Science Notes and News</i> .. ..	191



## CALIBRATED SHUNTS

For Potentiometer Work  
**ACCURACY 0.1 PER CENT.**  
**WOUND OF MINALPHA WIRE**  
**WITH**  
**CURRENT & POTENTIAL TERMINALS**

Made by:  
**THE STANDARD SCIENTIFIC**  
**INSTRUMENTS Co.**

115, BRODIES ROAD, MADRAS 28

We offer our services for G. R. quality acids  
 with guaranteed test report as follows:—

### Acid Sulphuric, A.R. S.G. 1.84

Container	Resistant Glass
Non-Volatile matter	0.0025%
Nitrate	0.0003%
Chloride	0.0003%
Arsenic	0.00007%
Iron	0.0001%
Heavy Metal (as Pb)	0.0002%

### Ammonium Hydroxide, A.R. S.G. 91-2

Container	Resistant Glass
Non-Volatile matter	0.002%
Oxygen absorbed	0.0008%
Chloride	0.0001%
Sulphide	Passes Test
Sulphate	0.0003%
Carbonate	0.003%
Iron	0.00001%
Tarry matter	Passes Test
Arsenic	0.000005%
Heavy Metal (as Pb)	0.00002%

**LUCKY ACID & CHEMICAL WORKS**  
 32/2, Muraripukur Road, CALCUTTA-4

MADE IN INDIA  
 HIGH VACUUM  
**ROTARY PUMP**  
 SINGLE STAGE & TWO STAGE

Suitable for laboratory use and similar performance to those made in Germany, England and U. S. A.



All Indian materials and construction  
**BASIC & SYNTHETIC CHEMICALS,**  
**PRIVATE LTD.**

P.O. Jadavpur College, CALCUTTA 32

22-5009

INSIST ON



BRAND

MEGHINDUS



Laboratory  
**PORCELAIN-WARES**

DEPENDABLE — DURABLE

**MEGHNA**

INDUSTRIES PRIVATE LIMITED  
 22, CANNING ST. CALCUTTA 1

# Current Science

Vol. XXVII]

JUNE 1958

[No. 6

## CONTENTS

	PAGE
<i>Study of Cosmic Rays with Earth Satellites</i> .. .. .	195
<i>Geochemical Survey Techniques</i> .. .. .	197
<i>Clay Mineral Studies</i> —J. SHEARER .. .. .	198
<i>The Twistor</i> .. .. .	201
<i>Levels of Organisation in Cell Functions</i> —A. SREENIVASAN .. .. .	202
<i>Free Radicals in Cigarette Smoke</i> .. .. .	207
<i>Letters to the Editor</i>	
<i>Lipid Depleted Adrenal Cortex in Molybdenum Fed Rats and Its Prevention by Vitamin E</i> —P. P. NAIR AND N. G. MAGAR .. .. .	208
<i>Synthesis of 4-Hydroxy-6-Sulfonamide-Quinoline Derivatives</i> —KASHINATH S. SARDESAI AND S. V. SUNTHANKAR .. .. .	209
<i>Glutamic Acid Decarboxylase in Fusaria</i> —S. NATARAJAN .. .. .	210
<i>A Short Note on the Testing of R.W. Coefficient at Different Temperatures</i> —A. MUKHERJI .. .. .	210
<i>A Teratological Phenomenon in Lagerharia siceraria Standl.</i> —L. B. SINGH AND S. N. SINGH .. .. .	211
<i>Influence and Mechanism of Action of Low Temperature Pre-Treatment on Germination of Tobacco Seeds</i> —N. L. PAL AND N. C. GOPALACHARI .. .. .	212
<i>Influence of Certain Species of Earthworms on the Structure of Some Hill Soils</i> —G. S. AGARWAL, K. S. K. RAO AND L. S. NEGI .. .. .	213
<i>On the Occurrence and Life-Cycle of the Jak Weevil (Ochyromera artocarpici, Marshall) at Coimbatore</i> —T. R. SUBRAMANIAN .. .. .	214
<i>Root-Knot Nematodes on Potatoes in India</i> —PUSHKARNATH AND B. N. ROY CHOUDHARY .. .. .	214
<i>Effect of IAA and Kinetin on Pollen Tubes of Pinus roxburghii Sar.</i> —R. N. KONAR .. .. .	216
<i>Note on the Estimation of Starch in Sugarcane</i> —K. V. GOPALA AIYAR AND K. CHIRANJIVI RAO .. .. .	218
<i>On the Phenolic Content of Sugarcane and Spontaneum Juices</i> —K. PARTHASARATHI AND M. VIJAYASARADHY .. .. .	218
<i>Response to Touch Stimuli by a Tenebrionid Beetle, Gonocephalum depressum K.</i> —A. K. DATTA GUPTA AND B. B. GUPTA .. .. .	219
<i>Cobalt and Zinc Contents of a Few Forage Plants of Western India</i> —(MISS) JAYA G. IYER AND Y. SATYANARAYAN .. .. .	220
<i>Detection of Mustard Oil in Other Edible Oils</i> —S. N. MITRA, B. R. ROY AND P. N. SENGUPTA .. .. .	221
<i>Reviews</i> .. .. .	222
<i>Science Notes and News</i> .. .. .	228

# HINDUSTAN ANTIBIOTICS (PRIVATE) LTD.

(GOVERNMENT OF INDIA UNDERTAKING)

PIMPRI (NEAR POONA)

## EMPLOYMENT NOTICE No. 5/58

APPLICATIONS in the prescribed form are invited on or before 26th July, 1958 for the following posts from persons with minimum qualifications mentioned against each :

- (1) **Senior Scientific Officer - Grade 1** Organic Chemistry Section (1 post).  
*Scale* : Rs. 600-40-1000-50/2-1150.  
*Qualifications* : Ph.D. in Organic Chemistry with five years research experience and must be capable of organizing and carrying out research work on isolation, purification and chemical characterisation of antibiotics and mould metabolites.
- (2) **Junior Scientific Officer - Mycology** : (1 post)  
*Scale* : Rs. 275-25-500-EB-30-590.  
*Qualifications* : Doctorate in Science (Mycology) or M.Sc. in Mycology with adequate research experience and knowledge of moulds with reference to their identity, physiology and handling for antibiotic production.
- (3) **Junior Scientific Officer - Microbiology** : (1 post)  
*Scale* : Rs. 275-25-500-EB-30-590.  
*Qualifications* : Doctorate in Science (Microbiology) or M.Sc. in Microbiology with adequate research experience and knowledge of microbiological assay methods for antibiotics and vitamins.  
*Desirable* : Experience in handling tissue cultures and embryonated eggs in virus work.
- (4) **Technical Assistant - Mycology** : (1 post)  
*Scale* : Rs. 160-10-330  
*Qualifications* : B.Sc. (Hons.) or M.Sc. with Mycology or plant pathology as special subject. Knowledge of fungi groups and handling them in research work on antibiotics.
- (5) **Assistant Librarian** : (1 post)  
*Scale* : Rs. 160-10-330.  
*Qualifications* : A degree in Science and a Diploma or Degree in Library Science from a recognised institution preferably with knowledge of one European Language and experience of one or two years in a technical library.
- (6) **Junior Technical Assistants - Mycology** : (2 posts)  
*Scale* : Rs. 100-5-120-EB-8-200-10/2-220.  
*Qualifications* : B.Sc. in Botany or Agriculture preferably with knowledge of preparing and maintaining cultures.  
*Age Limit* : For the posts (1) to (5) 35 years and for the last post 30 years on 1-8-1958 relaxable in case of exceptionally well qualified and experienced candidates and others belonging to scheduled caste/tribes.

Prescribed application forms are available with the Accounts Officer on payment of Re. 1/- by crossed Indian postal order drawn in favour of **Hindustan Antibiotics (Private) Limited**, Pimpri, payable at Penicillin Factory Post Office accompanied by a self-addressed adequately stamped envelope.

**S. T. RAJA**  
*Managing Director*

# Current Science



Vol. XXVII]

JULY 1958

[No. 7

## CONTENTS

	PAGE
<i>Physical Conditions in Space</i> .. .. .	231
<i>Recent Developments in Ion-Exchange</i> .. .. .	232
<i>Darwinism through Hundred Years</i> —P. K. MENON .. .. .	233
<i>Fischer-Tropsch Process</i> .. .. .	237
<i>Stacking Faults in Closepacked Metallic Lattices</i> —Part I. <i>The Nature and Origin of Stacking Faults</i> —T. R. ANANTHARAMAN .. .. .	238
<i>Origin of Radio Bursts from the Sun</i> .. .. .	241
<i>Microtron</i> .. .. .	268
<i>Letters to the Editor</i>	
<i>The Fluorescence Spectra of Uranyl Acetate Solutions</i> —D. D. PANT AND D. P. KHANDELWAL .. .. .	242
<i>The Preparation of Uranium (IV) Oxymformate</i> —B. SAHOO AND D. PATNAIK .. .. .	243
<i>Utilization of the Solubility Data for the Calculation of the Composition, Stability and Free Energy of Formation of the Complex Formed in the System: AgCNS-NH<sub>3</sub>-H<sub>2</sub>O</i> —ROSHAN LAL SETH AND ARUN K. DEY .. .. .	244
<i>Initiation of Polymerisation of Methyl Methacrylate in Aqueous Solution by Hydrazine Hydrate</i> —C. C. MENON AND S. L. KAPUR .. .. .	245
<i>Spectrophotometric Method for Estimation of Calcium in Sugarcane Juices Using Ethylenediaminetetraacetic Acid</i> —N. A. RAMAIAH, VISHNU AND R. K. CHATURVEDI .. .. .	246
<i>Transference Number in Barium Thiocyanate and Lead Nitrate by a Moving Boundary Technique</i> —J. N. SAHAY .. .. .	247
<i>On the Temperature and Salinity Structures of the Bay of Bengal</i> —C. BALARAMA MURTY .. .. .	249
<i>Beneficial Effect of Prolongation of the Weaning Period on the Weights of Rats</i> —P. K. DIKSHIT .. .. .	250
<i>Variation of Compressional Velocities in Indian Rocks at Low Pressures</i> —S. BALAKRISHNA .. .. .	251
<i>On the Bacteriological Study of Toned Milk</i> —SATYA RANJAN SARKAR .. .. .	252
<i>A Note on Gaffkya Species Isolated from Indian Earthworm</i> —S. R. KHAMBATA AND J. V. BHAT .. .. .	253
<i>Synthesis of 7, 10-Dimethoxy-5, 6, 11, 12-Tetrahydro Naphthacene-6, 12-Dione</i> —A. L. PANDIT AND A. B. KULKARNI .. .. .	254
<i>Tocopherol Content as an Index of Adulteration of Ghee</i> —R. A. RAMANUJAN AND C. P. ANANTAKRISHNAN .. .. .	255
<i>Fructose-Glucose Relation during Vegetative and Reproductive Stages in Sugarcane</i> —K. PARTHASARATHI AND M. VIJAYASARADHY .. .. .	257
<i>A New Bacterial Blight of Cyamopsis tetragonoloba (L.) Taub.</i> —A. J. PATEL AND M. K. PATEL .. .. .	258
<i>A Note on Hepatic Flora of Mt. Abu</i> —K. R. BAPNA .. .. .	259
<i>A New Species of Cercospora on Blumea lacera DC.</i> —SITANATH DAS .. .. .	260
<i>Akinete Formation in the Genus Hormidium (Kütz.) Klebs.</i> —K. P. SINGH .. .. .	261
<i>Occurrence of Growth Checks in the Scales of the Indian Mackerel, Rastrelliger canagurta (Cuvier)</i> —G. SESHAPPA .. .. .	262
<i>The Second-Instar Larval Cuticle of Attacus ricini</i> —R. K. SHARAN AND S. L. SAHNI .. .. .	264
<i>Occurrence of Anchoviella insularis Hardenberg off Waltair Coast</i> —S. DUTT AND M. BABU RAO .. .. .	265
<i>Note on the Proteins from the Seeds of Sesbania grandiflora</i> —D. NARAYANAMURTI AND R. C. KOHLI .. .. .	266
<i>A Chemical Examination of Emblica officinalis, Gaertn.</i> —P. P. PILLAY AND K. MAHADEVA IYER .. .. .	266
<i>Cytoplasmic Male Sterility in Psyllium (Plantago ovata Forsk.)</i> —C. K. ATAL .. .. .	268
<i>Reviews</i> .. .. .	269
<i>Science Notes and News</i> .. .. .	274

# PANJAB UNIVERSITY

*Applications are invited for the post of :*

**Reader in Statistics:** *Grade* Rs. 500-30-800, *plus* allowances admissible under University Rules, with benefit of Provident Fund on confirmation.

**Qualifications: Essential:** Brilliant academic career followed by research work of quality and competence to guide research. **Desirable:** Experience of teaching post-graduate classes. Applications stating age, present pay, academic qualifications, teaching and research experience, names of two referees, with copies of Research publications and attested copies of the certificates and Degrees of the examinations passed and testimonials, should reach **Sbri J. R. Agnihotri, M.A., Registrar, P.U., Chandigarh, by 15th August 1958.** Candidates who have already applied for this post need not apply again.

## AVAILABLE IN STOCK

For Laboratory Grinding and Mixing

Small Electric Grinding Mills            ..            ..    Rs. 80  
Liquidisers            ..            ..            ..            ..    Rs. 150

*Made by:*

HILMAN ELECTRIC MOTORS LTD., LONDON

Wet and Dry Bulb Glass Hygrometers    ..            ..    Rs. 45  
Range 0° C. to 100° C.

Maximum and Minimum Thermometers    ..            ..    Rs. 45  
Range 0° C. to 100° C.

*Made by:*

G. H. ZEAL LTD., LONDON

"Sopac" French Make Dial Thermometers            ..    Rs. 190-220  
6" diameter, distant reading,  
various ranges

Krupps, German Make, 'Nova' Personal  
Weighing Machines, capacity 280 lb.            ..    Rs. 60

**KINLAB (PRIVATE) LTD.**

5, MARQUIS STREET, CALCUTTA 16

# Current Science

Vol. XXVII]

AUGUST 1958

[No. 8

## CONTENTS

PAGE

Cosmology .. .. .	279
Haffkine Institute—Diamond Jubilee .. .. .	280
Nuclear Spectroscopy: Study of Allowed and Forbidden Beta-Spectra— B. V. THOSAR .. .. .	281
Recent Advances in Airphoto Geology—PETER E. WOLFE .. .. .	283
Ortho-Para-Catalysis in Liquid-Hydrogen Production .. .. .	286
Stacking Faults in Close-Packed Metallic Lattices—Part II. The Measure- ment of Faulting Parameters—T. R. ANANTHARAMAN .. .. .	287
The Photolysis of Uranyl Oxalate and the Preparation of Uranium (IV) Oxy- oxalate and Oxalate—D. PATNAIK AND B. SAHOO .. .. .	292
Eighth Annual High Energy Physics Conference at CERN—G. B. YODH .. .. .	294
Obituary—Professor K. V. Giri .. .. .	295
Boron Rocket Fuels .. .. .	314

### Letters to the Editor

Fading of Radio Waves—P. VENKATES- WARLU AND R. SATYANARAYANA .. .. .	296	Stem-Canker, A Sclerotial Disease of Hollyhock ( <i>Althaea rosea</i> Cav.) from India—B. B. SHARMA .. .. .	304
Magnetism and Molecular Structure: Proximity Effect in Ortho-Substituted Benzoic Acids—D. D. KHANOLKAR .. .. .	296	Variation in the Proventricular Structure in the Cockroach <i>Periplaneta americana</i> (Linn.)—N. P. KALYANAM .. .. .	305
A Method of Electrolytic Etching of Tan- talam for Capacitor Use—INDRA SANGHI .. .. .	297	Development of the BHC Resistance in <i>Musca nebulosa</i> under Field Conditions— Z. H. ABEDI AND N. H. KHAN .. .. .	306
Photochemical Properties of Nickel Com- pounds—K. VEERIAH .. .. .	298	The Effect of Molybdenum on the Rate of Growth and Nitrate Absorption by <i>Cylindrospermum sphaerica</i> —G. S. VENKATARAMAN .. .. .	306
Double Bond Reactivity of Unsaturated Fatty Acids in Mineral Flotation— R. MALLIKARJUNAN AND V. RAMA- CHANDRAN .. .. .	299	On the Red Alga <i>Corynomorpha prisma- tica</i> —M. S. BALAKRISHNAN .. .. .	307
Geology of Adikmet Area, Hyderabad— DR. S. BALAKRISHNA, PROF. PETER E. WOLFE AND N. RAJA .. .. .	300	Insect Incidence and Branching in Rice— P. ISRAEL AND G. VEDA MOORTHY .. .. .	309
Effect of Blanching on Enzymic Brown- ing in Green Amari Apple—G. S. SIDDAPPA AND B. S. BHATIA .. .. .	300	Chromosomes of Three Species of South Indian Pulmonate Snails of the Genus <i>Cryptozona</i> Morch.—R. NATARAJAN .. .. .	311
Mosaic Disease of Brinjal: A Correction— P. M. VARMA AND T. K. NARIANI .. .. .	302	<i>Cycadopteris</i> Sp. from the Rajmahal Hills, Bihar—M. N. BOSE .. .. .	312
A Note on the Organic Production in the Inshore Waters of the Gulf of Mannar —R. RAGHU PRASAD, V. KRISHNA PILLAI AND P. V. RAMACHANDRAN NAIR .. .. .	302	Cytological Studies in <i>Fissidens elimba- tus</i> , Broth, a Local Moss—R. P. ROY AND M. K. JAIPURIAR .. .. .	312
The Kinetochore Problem in Hemiptera— S. R. VENKATASUBBA RAO .. .. .	303	Cytoplasmic Male Sterility in Jowar ( <i>Sorghum vulgare</i> Pers.)—S. P. MITAL, VISHNU SWARUP AND A. B. JOSHI .. .. .	314

Reviews .. .. . 315

Science Notes and News .. .. . 321.

## SPECIAL PRE-PUBLICATION ANNOUNCEMENT



The United Nations announces the publication in English of the complete **PROCEEDINGS OF THE SECOND UNITED NATIONS INTERNATIONAL CONFERENCE ON THE PEACEFUL USES OF ATOMIC ENERGY** (Geneva, September 1st to 13th, 1958).



More than 2,200 papers (double the number presented at the 1955 Conference) covering all aspects of the Peaceful Uses of Atomic Energy will be presented at the Conference in which approximately 70 countries will participate and discuss their latest achievements, both experimental and practical. The main subjects of the Conference are listed below :



Basic physics	Possibility of controlled fusion
Basic chemistry	Raw materials
Biology and medicine	Production of nuclear materials
Use of nuclear energy for purposes other than generation of electricity	Research and power reactors
Thermonuclear developments	Reactor technology
	Production and uses of isotopes
	Training in nuclear sciences



The English edition is expected to consist of 34 volumes (approximately 500 pages each), which will become available beginning December 1958; publication is expected to be completed by June 1959.

A special pre-publication price of \$ 435 (current equivalent Rs. 2071·47) for the complete set is now available, and orders will be accepted on this basis until November 30, 1958. The regular price for the full set will approximate \$ 510 (current equivalent Rs. 2428·62).

Abridged editions in French and Spanish are planned for simultaneous publication. They will consist mainly of the papers presented orally at the Conference (approximately 500), the papers submitted in the language of the edition, and a selection of other papers. These editions are expected to be in 15 volumes, and a pre-publication price is available (up to November 30, 1958) of \$ 190 (current equivalent Rs. 904·78).

### *For further details consult*

Messrs. Orient Longmans Ltd., 17, Chittaranjan Avenue, Calcutta; Nicol Road, Bombay; Mount Road, Madras; Kanson House, Ajmere Gate Extension, New Delhi; 17/60, Sanyasiraju Street, Vijayawada; or Messrs. Oxford Book and Stationery Co., Scindia House, New Delhi; or Messrs. P. Varadachary & Co., 8, Linghi Chetty Street, Madras, who are the sales agents for publications of the United Nations or

## UNITED NATIONS, NEW YORK

*Brochures giving further details available on request*

# Current Science

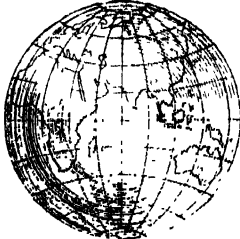

Vol. XXVII]

SEPTEMBER 1958

[No. 9

## CONTENTS

	PAGE
<i>The New Atlas of the Skies</i> .. .. .	325
<i>Arizona Meteorite Crater</i> .. .. .	326
<i>Relativity and Space-Travel</i> —V. R. TIRUVENKATACHAR .. .. .	327
<i>The Sector-Visual Method of Electron Diffraction: The Molecular Structure of Tetrachloroethene</i> —C. N. RAMACHANDRA RAO AND R. L. LIVINGSTON .. .. .	330
<i>Anomalous Transmission of X-Rays by Single Crystal Germanium</i> .. .. .	331
<i>Abnormal Ionospheric Behaviour at 10 Metres Wavelength</i> —M. KRISHNAMURTHI, G. SIVARAMA SASTRY AND T. SESHAGIRI RAO .. .. .	332
<i>Lithium Developments</i> .. .. .	333
<i>Some Applications of Oxygen in Steel-Making</i> —R. MALIKARJUNAN .. .. .	334
<i>Industrial Research at General Electric</i> —S. SAMPATH .. .. .	335
<i>Decoration of Dislocations</i> .. .. .	336
<i>Letters to the Editor</i>	
<i>Solution Stability Constants of Some Metal Chelates of o-Hydroxy-Acetophenone Oxime</i> —M. B. KABADI AND K. A. VENKATACHALAM .. .. .	337
<i>Sintering of Thoria</i> —S. K. KANTAN, R. V. RAGHAVAN AND G. S. TENDOLKAR .. .. .	338
<i>Ultrasonic Absorption Measurements in MgSO<sub>4</sub>, ZnSO<sub>4</sub>, CoSO<sub>4</sub> and NiSO<sub>4</sub> at 3 Mc./Sec</i> —SUSHIL KUMAR KOR .. .. .	339
<i>The Raman Spectrum of Pyridine N-Oxide</i> —K. RAMIAH AND V. R. SRINIVASAN .. .. .	340
<i>Resorcinol as a Reagent for the Spectrophotometric Determination of Uranium</i> —P. C. JAIN AND G. S. RAO .. .. .	340
<i>Inactivation of Azotobacter by Heat</i> —V. ISWARAN AND ABHISWAR SEN .. .. .	341
<i>A Synthesis of Isochromene</i> —J. N. CHATTERJEA .. .. .	342
<i>Infestation of Leather Cruppers by the Tobacco Beetle Lasioderma serricorne Fabr.</i> —P. S. CHEEMA, J. N. MISRA, S. L. PERTI AND S. K. RANGANATHAN .. .. .	343
<i>Ascorbic Acid in Germinating Seeds of Sesbania grandiflora Pers.</i> —S. KUPPUSWAMY, J. MEENA RAO, M. SRINIVASAN AND V. SUBRAHMANYAN .. .. .	343
<i>On the Application of 'Probable Error' in the Study of Zircons in Nandi Granites</i> —A. ACHUTHARAO .. .. .	345
<i>Heavy Minerals in the Cauvery River Sands Near Talkad, Mysore</i> —C. PARAMASIVIAH .. .. .	346
<i>Occurrence of Monazite in the Charnockites of Visakhapatnam</i> —M. S. MURTY .. .. .	347
<i>On a New Species of Procamallanus Baylis, 1923 (Nematoda)</i> —S. C. AGARWAL .. .. .	348
<i>Dredging and Phytoplankton Production</i> —P. N. GANAPATI AND D. V. SUBBA RAO .. .. .	349
<i>Neurosecretory Cells of the Brain of the Leech Hirudinaria granulosa (Sav.)</i> —P. N. NAMBUDIRI AND K. P. VIJAYAKRISHNAN .. .. .	350
<i>Occurrence of Parapenaeopsis cornutus Kishinouye in the Seas of India</i> —D. MEHENDALE AND V. B. TEMBE .. .. .	351
<i>Assemblage of Ten Species of Coccinellid Beetles on Banyan Trees at Kundri Forest in Bihar</i> —C. P. MALHOTRA AND S. KRISHNASWAMI .. .. .	351
<i>Respiratory System of the Queen of Formica fusca L.</i> —G. T. TONAPI .. .. .	352
<i>Variation in the Stamen Number in Oryza brachyantha A. Cheval. et Roehr. and the Frequency of Occurrence of 3-Styled Gynoeceae in O. grandiglumis Prodoehl</i> —W. T. BUTANY .. .. .	354
<i>A New Terrestrial Species of Oedogonium (Oe. randhawae sp. Nov.) from West Bengal, India</i> —G. S. VENKATARAMAN .. .. .	355
<i>Effect of Pre-Soaking Seed Treatment with 2-Methylbenzimidazole on Rice Seedlings</i> —G. MISRA AND D. MISHRA .. .. .	356
<i>Cytology of Two Species of Salviniaceae</i> —D. S. LOYAL .. .. .	357
<i>'Chimera' in Tur (Cajanus cajan Millsp.)</i> —J. A. PATIL AND N. V. SANDBHOR .. .. .	358
<i>Chromosome Numbers of Some South Indian Species of Vitaceae</i> —B. V. SHETRY .. .. .	358
<i>Occurrence of Carapa spp. in the So-called Peat Bed near Calcutta</i> —S. S. GHOSH AND B. S. NEGI .. .. .	359

Reviews .. .. . 361



# UNIVERSITY OF ALLAHABAD

**W**ANTED a Professor in Applied Physics in the grade of Rs. 800-50-1250. Applicants must possess high academic qualifications, with at least five years' teaching experience of the subject in a University. The candidate must be a reputed investigator in the field of electronics and should be capable of developing a school of research in electronics. He must have established reputation for scholarship, teaching and ability to teach post-graduate classes and guide and conduct research upto the highest research degree of the University. He will be responsible for the organisation of different courses in electronic technology and administration of the Department. Higher initial salary within the grade is admissible in case of a candidate of exceptional merit. The post in the first instance is upto February 28, 1961.

Applications on the prescribed form (*to be had on prepayment of Rs. 5/- either in cash or by Money Order—Postal Orders and cheques will not be accepted*) with attested copies of testimonials and reprints must reach the Registrar by October 10, 1958.

Canvassing will be a disqualification.

**K. L. GOVIL**  
Registrar



## SOLENOID INDUCTOR

NEW DESIGN FOR ACCURACY



PRIMARY . . . . . 200 TURNS  
SECONDARIES . . 200 & 20 TURNS  
WOUND ON INSULATING FORMERS  
ON EBONITE MOUNTS

Made by:

**THE STANDARD SCIENTIFIC  
INSTRUMENTS CO.**  
115, BRODIES ROAD, MADRAS 28

Just Out . . .

## A TREATISE ON HEAT

INCLUDING KINETIC THEORY, THERMO-  
DYNAMICS, STATISTICAL MECHANICS  
AND THERMAL IONIZATION

BY  
**M. N. SAHA, F.R.S.**  
AND  
**B. N. SRIVASTAVA, D.Sc.**

4TH EDITION, 975 PAGES, 287 DIAGRAMS  
PRICE Rs. 38/-

Previous editions of the book have already been hailed by the scientific world as one of the best heat books of modern times. In this fourth edition the book has been thoroughly revised and such modern topics as low temperature physics, thermal diffusion, etc., have been brought up to date and some additional topics such as the thermodynamics of irreversible processes, etc., added.

**INDIAN PRESS (Pubs.) PRIVATE LTD.**  
ALLAHABAD, U.P., INDIA

# Current Science

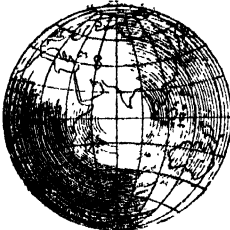

Vol. XXVII]

OCTOBER 1958

[No. 10

## CONTENTS

	PAGE
<i>Science in Eastern Europe: 1</i> —SIR C. V. RAMAN .. .. .	371
<i>Golden Jubilee of the Indian Institute of Science, Bangalore</i> .. .. .	375
<i>Information Theory and Some of Its Applications</i> —B. S. RAMAKRISHNA .. .. .	376
<sup>12</sup> C as Reference Nuclide .. .. .	385
<i>Geothermal Power</i> .. .. .	386
<i>Letters to the Editor</i>	
<i>A Method for Estimating the Ultrasonic Velocity in Solids</i> —K. C. LAL .. .. .	387
<i>Polarization Studies on Chromate-Treated Zinc</i> —K. S. RAJAGOPALAN AND K. BALAKRISHNAN .. .. .	387
<i>Chemical Investigation of Coriandrum sativum</i> —(MISS) D. D. VAGHANI AND V. M. THAKOR .. .. .	388
<i>Solubility of Phosphorus Oxylchloride-Aluminium Chloride Complex</i> —K. N. VENKATARAMAN AND A. R. VASUDEVA-MURTHY .. .. .	389
<i>Solvolysis of 1-Phenyl-n-Propyl Chloride</i> —G. GOPINATHAN NAIR AND R. ANANTARAMAN .. .. .	390
<i>Observations on the Role of Methionine in Experimental Malaria (P. gallinaceum in Chick Malaria)</i> —R. RAMARAO, K. NAGARAJAN, A. S. RAMASWAMY AND M. SIRSI .. .. .	390
<i>Potentiometric Determination of Thermodynamic Functions of Dissociation of Gallic Acid</i> —N. A. RAMAIAH, S. L. GUPTA AND R. K. CHATURVEDI .. .. .	392
<i>Nitrogen Content and Yield of Some Sugarcane Varieties</i> —AMBIKA SINGH AND BALJIT SINGH .. .. .	393
<i>Hitherto Unrecorded Occurrence of Datura innoxia Mill. in the Upper Gangetic Plain and the Rajasthan Desert</i> —R. K. JAIN .. .. .	394
<i>Record of a New Pholad, Penitella sp., from Shingle Island (in the Gulf of Mannar) with a Note on Its Distribution</i> —P. N. GANAPATI AND R. NAGABHUSHANAM .. .. .	394
<i>Mating Types in Stylynychia pustulata</i> —M. V. NARASIMHA RAO .. .. .	395
<i>The Occurrence of Scyphistoma Larvae in Visakhapatnam Harbour</i> —P. N. GANAPATI AND M. V. LAKSHMANA RAO .. .. .	396
<i>Abnormal Pollen Tube Development in a Nicotiana Hybrid</i> —K. V. KRISHNAMURTY AND K. APPARAO .. .. .	397
<i>Studies on the Dietary Requirements of the Hide Beetle (Dermestes maculatus Degeer, Dermestidae: Coleoptera) with Particular Reference to Amino Acids and Vitamins</i> —B. S. LALL .. .. .	399
<i>Chromocenters and Nucleolar Equivalents in the Yeast Nucleus</i> —(MISS) SARASWATHY ROYAN .. .. .	400
<i>The Effect of Cortisone on the Distribution and Concentration of Alkaline Phosphatase in the Uropygial Gland of Male Pigeons</i> —S. P. BHATTACHARJEE AND A. GHOSH .. .. .	401
<i>A Note on Aphids of Calcutta and Suburbs with Special Reference to the Newly Recorded Host Plant Families for Some of the Species</i> —D. N. RAY CHAUDHURI AND A. K. GHOSH .. .. .	402
<i>Homology of the Pappus in the Light of Trichome Distribution</i> —N. RAMIAH AND M. SAYEEDUDDIN .. .. .	402
<i>Inheritance Study in Wheat</i> —J. A. PATIL .. .. .	404
<i>Note on Alternate Host Plants of Chilo zonellus Swinhoe</i> —DHAMO K. BUTANI .. .. .	405
<i>Chromosome Number in Iberis umbellata L.</i> —P. N. BALI AND S. L. TANDON .. .. .	405
<i>Chromosome Number in Chlorophytum tuberosum, Baker</i> —L. S. S. KUMAR AND H. K. SHAMA RAO .. .. .	406
<i>A Preliminary Study of Colchicine-Induced Polyploids of Alyssum maritimum Lam.</i> —P. N. BALI AND S. L. TANDON .. .. .	407
<i>Iodine Content of Some Indian Fodder Plants</i> —(MISS) JAYA G. IYER .. .. .	408
<i>A Short Note on Some of the Indian Solanum Species</i> —S. S. CHAUDHARY, VISHWA PAUL AND K. L. HANDA .. .. .	409
<i>Occurrence of Isoetes in Madhya Pradesh</i> —RAMJI SHARMA, R. M. PATEL AND S. S. MOGHE .. .. .	410
<i>Occurrence of a Green Jassid—Empoasca Sp.—on Sesbania speciosa L.</i> —E. V. ABRAHAM .. .. .	410
<i>Reviews</i> .. .. .	411
<i>Science Notes and News</i> .. .. .	418

# PANJAB UNIVERSITY

## WANTED

Lecturer in Physiology and Pharmacology.

*Grade:* 250-20-450-EB-25-650 *plus* allowances as admissible under the University Rules.

*Qualifications:* M.B.B.S. or M. Pharm. with three years teaching experience of M.B.B.S. or B. Pharm. class in Physiology or Pharmacology. Post-Graduate Training in Physiology and Pharmacology and research experience in these subjects will be considered additional qualifications.

Applications stating age, academic qualifications and experience with attested copies of University certificates and testimonials, published books or papers should reach **Shri J. R. Agnihotri, Registrar, P.U., Chandigarh**, by November 15, 1958.

## NATIONAL ATLAS OF INDIA

HINDI EDITION 1957

*A Government of India Publication*

Containing over 100 maps and printed in full colours on 26 separate plates, this Atlas depicts all available and upto-date information on the physical, economic, social and demographic facts about India.

*Explanatory notes and legends and reference map with place-names in English make this Atlas intelligible to English-knowing readers also.*

*Available from authorised book-sellers, Map Sales Agents or*

**DIRECTOR**

**NATIONAL ATLAS ORGANISATION**

SENATE HOUSE, CALCUTTA-12



**PRICE:**

Rs. 125 per copy

(De Luxe Edn.)

Rs. 100 per copy

(Popular Edn.)

25% trade discount to authorised booksellers and Map Sales agents

# Current Science



Vol. XXVII]

NOVEMBER 1958

[No. 11

## CONTENTS

	PAGE
<i>Science in Eastern Europe: II</i> —SIR C. V. RAMAN .. .. .	421
<i>Nobel Prize Awards for 1958</i> .. .. .	427
<i>Thermonuclear Energetics</i> —PROF. G. BABAT .. .. .	428
<i>Opto-Physical Measuring Instrument made by Veb Carl Zeiss, Jena, for Chemical Industries</i> —DR. W. NEBE .. .. .	430
<i>The End of a Wave</i> —R. PRASADA RAO AND E. C. LAFOND .. .. .	431
<i>New Superconductors</i> .. .. .	432
<i>Seismic Exploration for Oil in the Cambay and Neighbouring Areas, Bombay State</i> —L. N. KAILASAM .. .. .	433
<i>Testing and Standardisation of Foundry Materials</i> .. .. .	435
<i>Obituary</i> —DR. K. C. PANDYA .. .. .	435
<i>Letters to the Editor</i>	
<i>Stress and Wavelength Dependence of Birefringence in Cubic Crystals in the Visible Region</i> —K. S. IYENGAR AND K. G. BANSIGIR .. .. .	436
<i>Etching of Fluorite</i> —N. S. PANDYA AND J. R. PANDYA .. .. .	437
<i>A Note on Conductometric Studies on Copper Tungstates</i> —R. S. SAXENA AND C. M. GUPTA .. .. .	437
<i>Kinetic Studies in Chromic Acid Oxidations</i> —S. V. ANANTAKRISHNAN AND N. VENKATASUBRAMANIAN .. .. .	438
<i>Standard Resacetophenone Oxime in Spectrophotometry</i> —K. S. BHATKI, A. T. RANE AND M. B. KABADI .. .. .	439
<i>Toxicity of White Oil</i> —H. D. BRAHMA-CHARI .. .. .	440
<i>Studies in the Reactions of <math>\alpha</math>-Keto Acids</i> —(MISS) RASHMI J. SHAH AND J. R. MERCHANT .. .. .	441
<i>Southerly Pitching Anticline near Doddaguni</i> —K. M. GURAPPA .. .. .	442
<i>Sorel Cement as a Binder for Powder Fuel Wastes</i> —MOHAN RAI .. .. .	443
<i>Pillow Structures in the Ramagiri Schist Belt, Anantapur District, Andhra Pradesh</i> —M. KRISHNAMURTY .. .. .	444
<i>Root Relations of Orobanche and Its Hosts</i> —V. S. RAWAT AND R. S. AMBASHT .. .. .	445
<i>On the Prevention of Mango Necrosis</i> —S. N. DAS-GUPTA AND C. SEN .. .. .	446
<i>Role of Nitrogen in Host Susceptibility to Ptericularia oryzae Cav.</i> —S. SURYANARAYANAN .. .. .	447
<i>A Note on Coleus parviflorus Benth.</i> —R. SUNDARA RAGHAVAN .. .. .	448
<i>Stem Root of Rauwolfia serpentina</i> —P. D. VARADARAJAN .. .. .	448
<i>Head Organ Patterns Observed in Some Indian Fresh-water Dactylogyrids; Trematoda monogenea</i> —S. L. JAIN .. .. .	449
<i>Garra ethelwynnæ, a New Cyprinid Fish from Eritrea (Africa)</i> —A. G. K. MENON .. .. .	450
<i>The Free Amino Nitrogen Content as an Index of Quality of Ice-Stored Prawns</i> —N. K. VELANKAR AND T. K. GOVINDAN .. .. .	451
<i>The Visits of Insects to Different Coloured Flowers of Lantana camara L.</i> —KRISHNA R. DRONAMRAJU .. .. .	452
<i>A Note on the External Anatomy of Precis orithya, Swinhoe (Nymphalidæ: Lepidoptera)</i> —DHAMO K. BUTANI .. .. .	453
<i>Molybdenum Requirement of Selenastrum westii in Terms of Atoms Per Cell</i> —G. S. VENKATARAMAN AND K. V. NATARAJAN .. .. .	454
<i>Preliminary List of Helminth Parasites of Donkey (Equus asinus)</i> —P. RAI AND J. S. SRIVASTAVA .. .. .	456
<i>Cytogenetic Studies in Indian Silkworms. I. Preliminary Observations on Spermatogenesis in Castor Silkworm, Attacus ricini</i> —G. B. DEODIKAR AND C. V. THAKAR .. .. .	457
<i>Inheritance of Spot-Variation in Epilachna (Coleoptera: Coccinellidæ)</i> —B. S. LALL AND S. C. MANDAL .. .. .	458
<i>Reviews</i> .. .. .	459
<i>Science Notes and News</i> .. .. .	464

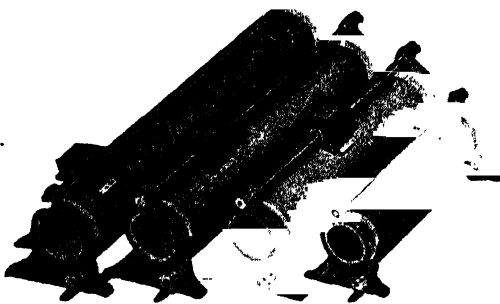

## 'STANDARD' RHEOSTATS

SINGLE, DOUBLE & FOUR-TUBE

COVER A WIDE RANGE  
FOR USE IN  
LABORATORIES & WORKSHOPS

*Made by :*

**THE STANDARD SCIENTIFIC  
INSTRUMENTS CO.**  
115, BRODIES ROAD, MADRAS 28

## JUST RELEASED

A thoroughly revised and upto-date edition

# NUCLEAR EXPLOSIONS AND THEIR EFFECTS

An altogether new book with  
fresh material included. Over 300  
pages in Royal 8vo. size with charts,  
maps and appendices.

Price Rs. 7-50

## PUBLICATIONS DIVISION

POST BOX No. 2011  
DELHI 8

DA-58/219

## NATIONAL ATLAS OF INDIA

HINDI EDITION 1957

*A Government of India Publication*

Containing over 100 maps and printed  
in full colours on 26 separate plates,  
this Atlas depicts all available and  
upto-date information on the physical,  
economic, social and demographic facts  
about India.

*Explanatory notes and legends and  
reference map with place-names in  
English make this Atlas intelligible to  
English-knowing readers also.*

*Available from authorised  
book-sellers, Map Sales Agents or*

**DIRECTOR  
NATIONAL ATLAS ORGANISATION  
SENATE HOUSE, CALCUTTA-12**



### PRICE:

Rs. 125 per copy  
(De Luxe Edn.)  
Rs. 100 per copy  
(Popular Edn.)

25 % trade discount to  
authorised booksellers  
and Map Sales agents

# Current Science

Vol. XXVII]

DECEMBER 1958

[No. 12

## CONTENTS

	PAGE
<i>Theoretical Physics in the United States of America</i> —ALLADI RAMAKRISHNAN	469
<i>Life of Satellites</i> .. .. .	473
<i>Cobalt-60 Used in Experiments to Convert Coal to Gas</i> .. .. .	473
<i>Electrical Effects in the Infrared and the Near Ultraviolet Absorption Spectra of Organic Isothiocyanates</i> —C. N. RAMACHANDRA RAO, J. RAMACHANDRAN AND S. SOMASEKHARA	474
<i>Geophysical Exploration in the Coastal Sedimentary Belt of Madras State</i> —L. N. KAILASAM	476
<i>Soviet Education for Science and Technology</i> —S. BHAGAVANTAM	479
<i>Symposium on Chemotherapy in Bacterial and Viral Infections</i> —V. N. K.	480
<i>U.S. 'Atlas' Missile</i> .. .. .	480
<i>Explorer IV, for Intensive Study of Cosmic Radiation</i> .. .. .	481
<i>Obituary</i> —Prof. W. Pauli .. .. .	481
<i>Letters to the Editor</i>	
<i>Fluorescence Reaction for the Detection of Boric Acid</i> —N. APPALA RAJU AND K. NEFLAKANTAM	482
<i>Nor-Pongamol from Pongamol</i> —C. BHEEMASANKARA RAO AND V. VENKATESWARLU	482
<i>Further Studies on the Influence of Thyroxine and Triiodothyronine on the Growth and Metabolic Processes in the Rice Moth Larvæ (Coreyra cephalonica St.)</i> —N. R. MOUDGAL, E. RAGHUPATHY AND P. S. SARMA	483
<i>The Condensing Enzyme in Garcenia Leaves (Xanthochymus guttiferæ)</i> —W. M. DESHPANDE AND C. V. RAMAKRISHNAN	485
<i>Determination of Blood Sugar Using 0.02 ml. of Fingertip Blood</i> —H. D. BRAHMACHARI AND MAHENDRA KUMAR	486
<i>Detection of Acetyl CoA Deacylase in Citric Acid Producing Strain of Aspergillus niger</i> —C. V. RAMAKRISHNAN AND P. N. RAJNA	487
<i>On the Sugar Constituents of Proceranin Saponin of Albizzia procera Benth.</i> M. O. FAROOQ, I. P. VARSHNEY AND HAMEEDUL HASAN	489
<i>Effect of Humus of Legume and Non-Legume Origin on the Nitrogen Fixation in Azotobacter chroococcum</i> —V. ISWARAN	489
<i>Granite-Pakhal Relationship (Yellandlapad Area)</i> —Y. JANARDAN RAO	490
<i>Sterility in Gram</i> —DHARAMPAL SINGH AND RADHEY SHYAM	491
<i>Blight of Sesame (Sesamum orientale L.) Caused by Alternaria sesami (Kawamura) N. Comb.</i> —N. N. MOHANTY AND B. C. BEHERA	492
<i>Studies on Virus Diseases of Plants in Madhya Pradesh. I. Green Rosette of Vinca</i> —R. P. GARGA	493
<i>Three New Bacterial Diseases of Plants from Bombay State</i> —L. MONIZ AND M. K. PATEL	494
<i>Selection of Murrah Buffaloes for Milk Yield on the Basis of Udder Conformation</i> —G. C. TANEJA AND D. S. BHATNAGER	495
<i>An Addition to Indian Aspergilli</i> —RAMA SHANKAR DWIVEDI	496
<i>A Case of Chromosomal Interchange in Pearl Millet</i> —J. V. PANTULU	497
<i>Interspecific Hybridization between Mucuna pruriens DC. and Mucuna cochinchinensis A. Chev.</i> —M. V. THOMBRE	498
<i>Ergot of Bajri (Pennisetum typhoides) in Bombay State</i> —P. A. SHINDE AND V. P. BHIDE	499
<i>Asexual Reproduction in Characiosiphon rivularis Iyengar</i> —RAMJI SHARMA	500
<i>Morphology of the Ovule of Zephyranthes citrina Baker</i> —B. S. M. DUTT	501
<i>Indian House Sparrow as an Enemy of the Desert Locust</i> —CHARAN SINGH	502
<i>Preliminary Observations on the Systemic Action of Three Organic Phosphates on the Red Cotton Bug [Dysdercus cingulatus (Fabr.), Hemiptera: Pyrrhocoridae]</i> —B. S. LALL AND M. TIWARY	503
<i>A New Cutworm Pest of Potato in Rajasthan</i> —B. K. SRIVASTAVA	503
<i>Spermatogonial Chromosomes of Two Lizards, Hemidactylus brooki Grey and Varanus mopitor Linn.</i> —A. N. BHATNAGER	504
<i>Reviews</i> .. .. .	506
<i>Science Notes and News</i> .. .. .	512

# PANJAB UNIVERSITY

## Department of Chemical Engineering and Technology

Applications are invited for **five** posts of **Readers** (Grade Rs. 500-30-800 *plus* allowances and benefit of Provident Fund as admissible under the University Rules) in the subjects of (i) Chemical Engineering, (ii) Physical Chemistry, (iii) Organic Technology, (iv) Inorganic Chemical Technology, and (v) Engineering (Electrical or Mechanical or both) and **Six** posts of **Lec'urers** (Grade Rs. 250-20-450-EB-25-650 with allowances and benefit of Provident Fund) in the subjects of (i) Fuel and Furnaces, (ii) Chemical Engineering, (iii) Organic Chemistry, (iv) Inorganic Chemistry, (v) Physical Chemistry and (vi) Physics.

The candidates must have bright academic record, should possess at least II Class Master's or Doctorate Degree in their special subject and should show aptitude for research as indicated by published work. The applicants for the posts of Readers should also have teaching or post-doctorate research experience of about 5 years. Experience of industry will be considered an additional qualification.

Applications, giving full details about qualifications, teaching and research experience, should reach the **Registrar, Panjab University, Chandigarh**, by the 15th of January 1959.

## INTRODUCTION TO THE GEOLOGY OF INDIA

By

DR. M. S. KRISHNAN

(viii + 185 pp.; 13 plates; 23 tables. Price Rs. 6.75; \$ 2.00 foreign)

A new and revised edition of this book is now available for sale. It gives a succinct account of the different geological formations of India, their distribution, mineral and fossil contents and other relevant details. It is indispensable to all undergraduates studying Geology and also to students of Geography, Agriculture, Forestry, Civil Engineering, Mining Engineering, etc.

*Also available:*

A Hindi translation of the book 'Introduction to the Geology of India' named as **BHARATHIYA BHOOTATWA KI BHOOMIKA**, translated by Srimati Akhilandeswari. Price: Rs. 8

## GEOLOGY OF INDIA AND BURMA

By

DR. M. S. KRISHNAN

Price: Rs. 22 50

**HIGGINBOTHAMS (PRIVATE) LTD.**

MOUNT ROAD : : MADRAS-2

# HIGH RESOLUTION RAMAN SPECTROSCOPY AND THE STRUCTURE OF SIMPLE MOLECULES

B. P. STOICHEFF

*Division of Pure Physics, National Research Council of Canada, Ottawa*

THE numerous investigations of the vibrational Raman spectra of molecules have made significant contributions to the development of our present ideas of molecular structures. From the frequencies, relative intensities and depolarization factors of vibrational Raman bands, valuable data on molecular symmetry, force constants and thermodynamic quantities have been obtained for a vast number of simple molecules. Usually, these data have been obtained from the Raman spectra of liquids, photographed at low dispersion.

Additional and much more precise information about the structure of molecules can be obtained from the investigation of the rotational Raman spectra of gases. When the rotational fine structure is resolved, it can lead to the evaluation of moments of inertia and hence internuclear distances and valence angles.

Immediately after the discovery of the Raman effect in 1928, observations of the rotational Raman spectra of diatomic and simple polyatomic molecules were reported by McLennan and McLeod, Rasetti, Wood, Dickinson, Dillon and Rasetti, Amaldi and Placzek, Lewis and Houston, Bhagavantam, and Teal and McWood. The results were of great significance for the development of the theory of the new effect as well as for a better understanding of molecular physics. In addition, these early experiments and the theory of Placzek and Teller clearly outlined the advantages and potentialities of rotational Raman spectroscopy for the determination of molecular structures. Nevertheless, until recently this experimental technique has not been used for structural determinations to any great extent.

Experimentally, the investigation of the Raman spectra of gases has been a difficult problem because of the low intensity of Raman scattering. The difficulties are further increased if the Raman spectra are to be photographed with sufficient resolution to separate the rotational lines. On the one hand, low gas pressures must be used to prevent excessive line broadening, and this of course reduces the amount of scattered light. On the other hand, it is desirable to use spectrographs of high resolving power, up to 100,000 but unfortunately

these are usually of low light-gathering power. Therefore a light source of very high intensity must be used to excite the Raman spectra and the scattered light must be collected and used with the utmost efficiency.

Recent improvements in apparatus have helped to overcome these difficulties to some degree so that Raman spectra of certain gases can now be photographed at high resolution with reasonably short exposure times. The major developments in apparatus include:

(a) a low pressure mercury arc operated at 20 to 30 amperes which emits sharp lines of high intensity with negligible continuum (Welsh, Crawford, Thomas and Love<sup>1</sup> and Stoicheff<sup>2</sup>).

(b) a system of concave mirrors of high reflectance in a long Raman tube which can superimpose about 40 cones of scattered light and therefore increase the efficiency of the Raman tube by almost this factor (Welsh, Cumming and Stansbury<sup>3</sup>). This high increase in efficiency over the conventional single-cone Raman tube arises in the following way. When the gas in the tube is irradiated, the molecules scatter light in all directions. Ordinarily, only a single cone of light enters the spectrograph, but of course there are an infinite number of such cones of light within the tube, any one of which would serve equally well. If some of these cones could be superimposed somehow, an enormous increase in observed light intensity would result. The mirror system achieves this to a limited extent and as already mentioned a factor of about 40 has been gained in this way.

An apparatus built in this laboratory is shown in Fig. 1. The multi-cone Raman tube is illuminated along a length of one metre by four mercury lamps and is completely enclosed in a reflector coated with magnesium oxide. A detailed description of this apparatus is given in reference 2.

With this apparatus it has been possible to photograph the pure rotation spectra and the rotation vibration spectra of several gases, with a 21 ft. grating spectrograph. The spectra are excited by the Hg 4358 line. At this wavelength, the reciprocal linear dispersion in the



## 2 High Resolution Raman Spectroscopy & Structure of Simple Molecules [Current Science

second order of the grating is  $6.7 \text{ cm.}^{-1}/\text{mm}$ . Gas pressures of 15 cm. to 35 cm. Hg are ordinarily used and exposure times vary from 1 to 20 hours. The slit width used is  $0.2 \text{ cm.}^{-1}$ , equal to the width of the exciting line, and the closest spacing of rotational lines to be resolved to date is  $0.37 \text{ cm.}^{-1}$ . The rotation vibration spectra are considerably fainter than the pure rotation spectra and therefore longer exposure times and higher gas pressures are necessary. The exposure times can be reduced by a factor of about 15, by placing a cylindri-

higher light-gathering power than the 21 ft. grating. With this apparatus, Professor Welsh and his co-workers have obtained some extremely interesting and valuable results on molecular structures. They have shown that high resolution studies of the rotational structure in vibrational Raman bands are now practical, and have recently carried out such investigations with a Raman tube 20 ft. long.

Precise information about the geometrical structure of diatomic and simple polyatomic molecules can also be obtained by a study of

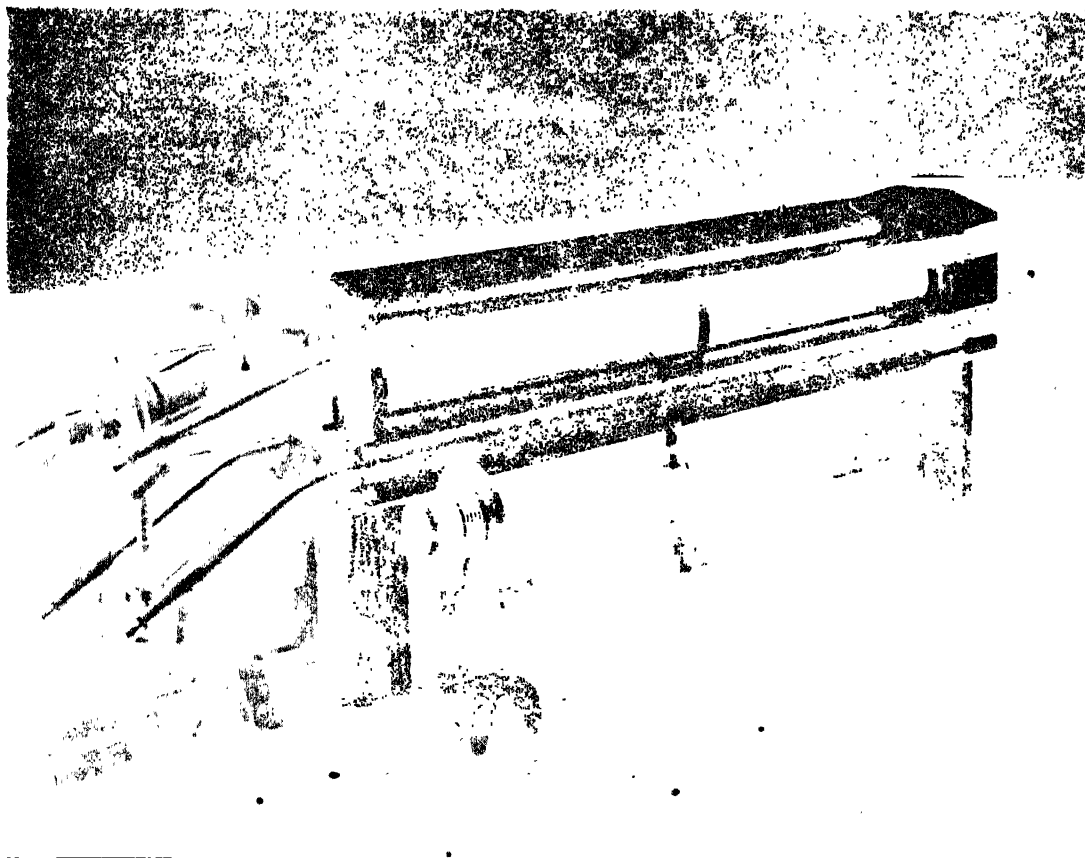

FIG. 1. An apparatus for high resolution Raman spectroscopy of gases. The rear mirrors are shown in the foreground. Electrical leads, water-cooling connections and part of the reflector housing have been removed.

cal lens in the spectrograph in front of the photographic plate.

A similar apparatus built at the University of Toronto<sup>4</sup> has been used primarily for the investigation of rotation vibration spectra. The Raman tube is illuminated along 150 cm., gas pressures up to four atmospheres are sometimes used, together with a prism spectrograph of

the rotational structure observed in their microwave, infrared and electronic spectra. While much valuable information has been obtained from these spectra there are inherent and experimental limitations in such investigations: some of which can be overcome by a study of the rotational structure in Raman spectra. These limitations have to some extent dictated

the problems which have been investigated by Raman spectroscopy. It may be worthwhile to discuss briefly some of these limitations, and to show how they may be overcome by investigations of Raman spectra.

All molecules with the exception of those with cubic symmetry have a pure rotational Raman spectrum. In contrast, only polar molecules exhibit rotation spectra in the microwave and far-infrared regions. As is well known, the same information about the ground state can be obtained from rotation-vibrational infrared spectra, but the vibration bands may be perturbed or overlapped by neighbouring bands and sometimes the rotational numbering cannot be ascertained. The pure rotation spectra are unperturbed, simple in appearance and usually easy to analyse. In the Raman effect, the exciting line defines the centre of the rotation spectrum and the rotational numbering can be determined unambiguously. Also, a check on the measurements is provided by a comparison of the Stokes and anti-Stokes lines.

For molecules with elements of symmetry the vibrational Raman spectra are complementary to the vibrational infrared spectra. The rotation-vibration spectra allow one to determine the effect of vibration on the rotational constants. Therefore the Raman and infrared vibration spectra must be investigated at high resolution if one is to eliminate the effect of zero point vibration and to determine the equilibrium structure. In addition, the rotational structure of certain vibrational bands is different in the Raman and infrared spectra. More rotational branches can appear in the Raman band and therefore valuable information can be obtained, which is not available from the infrared spectrum alone. These and other advantages will be illustrated by examples below.

For diatomic and linear polyatomic molecules the rotational energy levels of the ground state are given by the formula

$$\frac{E_r}{hc} = F_0(J) = B_0 J(J+1) - D_0 J^2(J+1)^2 + \dots \quad (1)$$

where  $E_r$  is the rotational energy in ergs,  $F_0(J)$  is the rotational term value in  $\text{cm}^{-1}$  and  $B_0 = h/(8\pi^2 c I_0)$ .

Here  $B_0$  is the rotational constant for the lowest vibrational level and is inversely proportional to the moment of inertia,  $I_0$ , for this level.  $J$  is the rotational quantum number which represents the total angular momentum of the molecule in units  $h/2\pi$ . The constant  $D_0$  represents the influence of centrifugal distur-

tion and is very small compared to  $B_0$ . For a vibrating molecule  $B_0$  is replaced by  $B_v$  where

$$B_v = B_0 - \sum_i \alpha_i (v_i + \frac{1}{2})$$

Here  $B_v$  is the rotational constant for the equilibrium position and the  $\alpha_i$  are small constants which determine the dependence of  $B$  on the different vibrations.

The occurrence of a pure rotational Raman spectrum for linear molecules (non-polar as well as polar), is due to the fact that the polarizability in a fixed direction changes during a rotation of the molecule about an axis perpendicular to its internuclear axis. The selection rules for Raman transitions are  $\Delta J = 0, 2$ . The rule  $\Delta J = 0$  gives the unshifted Rayleigh line which defines the centre of the rotation spectrum and  $\Delta J = 2$  gives the Stokes and anti-Stokes rotational lines known as S branches. The displacements of the rotational lines (in units  $\text{cm}^{-1}$ ) from the Rayleigh line are given by the equation

$$|\Delta\nu| = 4B_0 \left( J + \frac{3}{2} \right) - 8D_0 \left( J + \frac{3}{2} \right)^3 \quad (2)$$

Therefore we obtain a series of very nearly equidistant lines on either side of the Rayleigh line with the spacing of successive lines being  $4B_0$ . The  $J$  numbering of the lines is unambiguously obtained from the quotient of the displacement of a given line and the spacing  $4B_0$ . Precise values of the constants in equation (2) are then obtained graphically, by plotting  $|\Delta\nu|/(J+3/2)$  against  $(J+3/2)^2$ . The intercept gives  $4B_0$  and the slope  $8D_0$ .

In Fig. 2, some examples of pure rotational Raman spectra are shown, photographed with the N.R.C. 21 ft. grating. It can be seen that the lines are sharp and well-resolved and therefore accurate measurements can be made. Almost as many anti-Stokes lines are observed as Stokes lines, contrary to vibrational Raman spectra where usually only Stokes lines are observed. This is readily explained by the large number of molecules which are thermally excited into the various rotational levels at room temperature whereas only the lowest vibrational levels ( $< 500 \text{ cm}^{-1}$ ) are populated to any appreciable extent.

Values of rotational constants  $B_0$ , moments of inertia  $I_0$ , and internuclear distances  $r_0$ , obtained for various molecules by Raman spectroscopy are collected in Table I.

The most accurate values of the constants for the ground states of  $\text{H}_2$  and  $\text{N}_2$  are obtained from their Raman spectra. Indeed it is only a

few months ago that the electronic spectrum of  $N_2$  in the vacuum ultraviolet has been photographed with sufficient resolution to determine the molecular constants with an accuracy approaching that of the Raman-effect values. The difficulty has been one of limited resolution and a lack of reliable wavelength standards in the vacuum ultraviolet region: in con-

trast the Raman spectra are photographed in a very favourable wavelength region. The Raman spectra of  $H_2$ , HD and  $D_2$ <sup>5</sup> have provided precise values of  $\omega_1$  and  $B_0$ , as well as of the smaller yet significant constants  $D_0$  and  $H_0$  [the coefficient of the term  $J^3(J+1)^3$  in equation (1)]. In addition, the Raman results for the  $v = 0$  and 1 levels of  $H_2$  and HD were com-

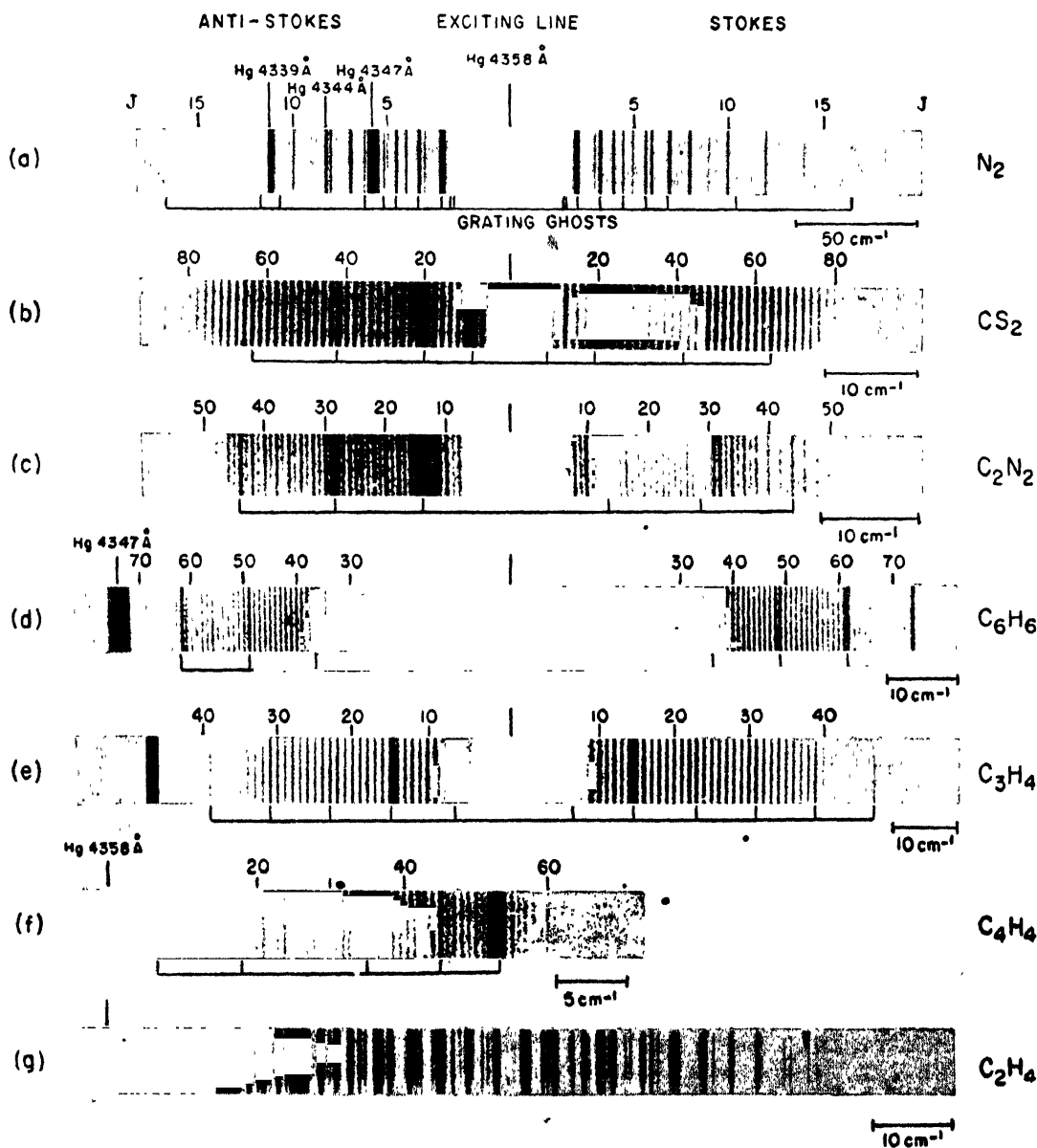

FIG. 2. Pure rotational Raman spectra photographed with a 21 ft. grating. (a) spectrum of  $N_2$ , (b, c) spectra of the linear molecules carbon disulphide and cyanogen, (d, e) spectra of the symmetric-top molecules, benzene and allene, (f, g) spectra (Stokes branches) of the slightly asymmetric-top molecules butatriene and ethylene.

TABLE I

Rotational constants, moments of inertia, and internuclear distances of molecules obtained from rotational Raman spectra

Molecule	$B_0$ (cm <sup>-1</sup> )	$I_0$ (10 <sup>-40</sup> g. cm. <sup>2</sup> )	$r_0$ (10 <sup>-8</sup> cm.)	
Hydrogen	H <sub>2</sub>	59.339 <sub>2</sub>	0.47168	
	HD	44.667 <sub>8</sub>	0.62660	
	D <sub>2</sub>	29.910 <sub>5</sub>	0.93576	
Fluorine	F <sub>2</sub>	0.8828	31.70 <sub>5</sub>	1.418
Nitrogen	N <sub>2</sub>	1.9897 <sub>3</sub>	14.067	1.1000 <sub>8</sub>
Carbon Disulphide	CS <sub>2</sub>	0.10910	256.54	1.554 <sub>5</sub>
Acetylene	C <sub>2</sub> H <sub>2</sub>	1.1760 <sub>2</sub>	23.782	$r$ (C=C) = 1.207
Cyanogen	C <sub>2</sub> N <sub>2</sub>	0.1573 <sub>2</sub>	177.69	$r$ (C-C) = 1.380
Ethylene	C <sub>2</sub> H <sub>4</sub>	1.008 <sub>5</sub>	27.75 <sub>3</sub>	$r$ (C=C) = 1.344
	C <sub>3</sub> H <sub>4</sub>	0.2963 <sub>3</sub>	94.389	
Allene	C <sub>3</sub> H <sub>2</sub> D <sub>2</sub>	0.2619 <sub>0</sub>	106.88 <sub>5</sub>	$r$ (C=C) = 1.309
	C <sub>3</sub> D <sub>4</sub>	0.2323 <sub>0</sub>	120.48 <sub>7</sub>	$r$ (C-H) = 1.07 ± 0.01
	C <sub>4</sub> H <sub>2</sub>	0.1468 <sub>0</sub>	190.54	$r$ (C-C) = 1.376
Diacetylene	C <sub>4</sub> D <sub>2</sub>	0.1276 <sub>7</sub>	219.40	$r$ (C-H) = 1.043
	C <sub>4</sub> H <sub>4</sub>	0.1314 <sub>1</sub>	210.13	$r$ (C=C) = 1.284
Butatriene	C <sub>4</sub> H <sub>6</sub>	0.1122	249.4 <sub>6</sub>	
Dimethylacetylene	C <sub>4</sub> H <sub>6</sub>	0.1413	198.15	
Butadiene-1, 3 (trans)	C <sub>4</sub> H <sub>6</sub>	0.1175	242.73	
	C <sub>4</sub> D <sub>6</sub>	0.1206	232.08	
Butene-2 (trans)	C <sub>4</sub> H <sub>8</sub>	0.1886 <sub>0</sub>	147.59	$r$ (C-C) = 1.397
	C <sub>6</sub> H <sub>6</sub>	0.1716 <sub>5</sub>	163.06	$r$ (C-H) = 1.084
	C <sub>6</sub> H <sub>3</sub> D <sub>3</sub>	0.1768 <sub>1</sub>	178.45	
	C <sub>6</sub> D <sub>6</sub>	0.2146 <sub>0</sub>	130.42	$r$ (C-N) = 1.338
s-Triazine	C <sub>3</sub> N <sub>3</sub> H <sub>3</sub>	0.1935 <sub>8</sub>	144.59	
	C <sub>3</sub> N <sub>3</sub> D <sub>3</sub>			

bined with Herzberg's data for higher vibrational levels in order to determine a set of equilibrium constants for the ground electronic states of these molecules. It was possible to apply various small corrections for the coupling of electronic and nuclear motions and hence to check the isotopic rules and to determine precisely the interproton distance in the hydrogen molecule.

The rotational Raman spectrum of F<sub>2</sub><sup>18</sup> is of importance since the only known electronic spectrum involving the ground state is continuous and gives no information on the vibrational and rotational constants. Although the Raman spectrum was photographed at low dispersion, a fairly reliable value of the internuclear distance was obtained. In addition the 3:1 intensity alternation for odd: even J showed that the F<sup>19</sup> nuclei obey Fermi statistics and confirmed their spin of 1/2.

The rotation spectra of CS<sub>2</sub>, C<sub>2</sub>H<sub>2</sub>, C<sub>2</sub>N<sub>2</sub> and C<sub>4</sub>H<sub>2</sub> have led to values of rotational constants and internuclear distances, which are as precise or better than those obtained from infrared or electronic spectra. In the spectrum of CS<sub>2</sub> (Fig. 2 b) only lines of even J appear since the spin of the S<sup>32</sup> nuclei is zero. Similarly the alternations of intensity observed in the

other spectra are in agreement with the linear symmetric structures of these molecules and with the known spin values and statistics of the nuclei.

For symmetric top molecules the rotational energy levels of a given vibrational level follow the formula

$$F(J, K) = B_r J(J+1) + (A_r - B_r) K^2$$

where  $A_r$  and  $B_r$ , apart from a constant, are the reciprocals of the moments of inertia  $I_a$  about the top axis and  $I_b$  about an axis perpendicular to the top axis. (Centrifugal distortion terms have been omitted.) The quantum number J represents the total angular momentum and K represents the component of J along the figure axis. The Raman selection rules for rotational transitions are  $\Delta K = 0$ :  $\Delta J = 1, 2$ . It is readily seen that the lines of the S branch ( $\Delta J = 2, \Delta K = 0$ ) are given by the same formula as for linear molecules, and lines of the R branch ( $\Delta J = 1, \Delta K = 0$ ) have half the spacing of the S lines and therefore extend only half as far from the exciting line. The rule  $\Delta K = 0$  gives rise to a simple appearance of the spectrum although the spectrum really consists of a superposition of several branches, one for each K value. (The exactness of coincidence of the lines depends

on the smallness of the centrifugal distortion terms.) Also, the rule  $\Delta K = 0$  accounts for the fact that the displacements of the rotational lines are only dependent on the constant  $B_0$  and not on  $A_0$ , that is only one moment of inertia can be determined from the spectrum.

One of the most interesting symmetric-top rotation spectra which has been studied is that of benzene shown in Fig. 2*d*. A series of well-resolved lines is observed on each side of the exciting line; these are the S branches with a line spacing of  $0.75 \text{ cm}^{-1}$ . Close to the exciting line there is a dense continuum partly due to overexposure of the exciting line and to grating ghosts, but mainly due to the R branch lines which are not resolved. The spectra of  $C_6H_6$  and  $C_6D_6$ <sup>7</sup> were photographed and analysed, and as a check the spectrum of symmetric  $C_6H_3D_3$  was investigated (see Table I). A measurement of these spectra together with the assumption that benzene is planar and hexagonal gave the internuclear distances  $r_0(C-C) = 1.397 \pm 0.001 \text{ \AA}$  and  $r_0(C-H) = 1.034 \pm 0.005 \text{ \AA}$ .

At the time of the first announcement of these results, Cox and Smith<sup>8</sup> using modern X-ray methods obtained a value of  $1.378 \pm 0.003 \text{ \AA}$  for the C-C distance in crystalline benzene at  $-3^\circ \text{C}$ . Their value differed by  $0.02 \text{ \AA}$  from the Raman-effect value for the free molecule and represented a significant discrepancy. This led to a re-examination of the X-ray data and to the subsequent discovery that the thermal oscillations in the plane of the molecule are markedly anisotropic. Angular oscillations of the whole molecule, about its six-fold axis, with r.m.s. amplitudes as large as  $8^\circ$  were found. As a consequence of such motions the maxima of the time-averaged electron distributions for the carbon atoms appear to be closer to the centre of rotation and hence result in a shorter C-C distance. This correction amounts to about  $0.015 \text{ \AA}$  for the C-C distance which brings the X-ray value to  $1.392 \text{ \AA}$ ,<sup>9</sup> very close to the spectroscopic value.

Another molecule for which the effects of such angular motions have led to a discrepancy of  $0.02 \text{ \AA}$  between the Raman-effect and X-ray values of internuclear distances<sup>10</sup> is symmetrical triazine ( $C_3H_3N_3$ ). Corrections of this magnitude may well be significant in other accurate structure determinations.

A recent investigation of infrared bands of allene ( $H_2C=C=CH_2$ ) led to a value of  $1.30 \text{ \AA}$  for the length of the C=C bond, which is significantly shorter than the C=C bond in ethylene ( $1.344 \text{ \AA}$ ). Since this result is of considerable importance\* for valence theory an

investigation of the rotational Raman spectrum was undertaken and spectra of  $C_3H_4$  (Fig. 2*e*)  $C_3HD_1$  and  $C_3H_2D_2$  were photographed.<sup>11</sup> Slightly different values of the constants were obtained. Complications in the infrared spectra did not permit clear resolution of the lines and resulted in incorrect rotational numbering. However, the result that the C=C bond length in allene is shorter than that in ethylene was confirmed, the length of the allene bond being  $1.309 \pm 0.001 \text{ \AA}$ . The Raman data are also consistent with the values  $r(C-H) = 1.07 \pm 0.01 \text{ \AA}$  and  $\angle HCH = 117 \pm 1^\circ$ .

One of the most closely-spaced rotation spectra so far resolved by the Raman method is that of dimethylacetylene ( $H_3C-C \equiv C-CH_3$ ). The line spacing is  $0.45 \text{ cm}^{-1}$  and leads to the value of the large moment of inertia given in Table I.<sup>12</sup> This single result is of course inadequate for finding the dimensions of this molecule, but when the dimensions of the related molecule methylacetylene ( $H_3C-C \equiv CH$ ) are taken over,  $r(C-C) = 1.460 \text{ \AA}$ ,  $r(C \equiv C) = 1.207 \text{ \AA}$  and  $r(C-H) = 1.097 \text{ \AA}$ , it can be shown that the calculated moment of inertia is smaller than the experimental value. This would suggest that at least one of the bond lengths is slightly larger than the value found in methylacetylene.

The rotation spectra of several slightly asymmetric top molecules have been investigated including *trans* 2-butene, 1,3-butadiene, butatriene and ethylene. In appearance, all these spectra (except that of ethylene) resemble those of symmetric tops and indeed this is to be expected since  $K$  remains a good quantum number and the selection rules for symmetric tops ( $\Delta K = 0$ ;  $\Delta J = 1, 2$ ) still hold approximately. Therefore the analyses of these spectra can be carried out according to equation (2), but instead of the rotational constant  $B_0$  one obtains  $\frac{1}{2}(B_0 + C_0)$ . Again, as for symmetric tops, only the one constant is obtained and, the lack of other data prevents the determination of the geometrical structures.

The present results for *trans* 2-butene ( $H_3C-CH=CH-CH_3$ ) are consistent with the following dimensions:  $r(C=C) = 1.344 \text{ \AA}$ ,  $r(C-C) = 1.500 \text{ \AA}$  and  $\angle (C=C-C) = 126^\circ$ . The observation of a resolved rotation spectrum for 1,3-butadiene ( $H_2C=CH-CH=CH_2$ ) shows that the *trans* form is the more stable configuration at room temperature: the *cis* form would give unresolved rotational bands. The results obtained for the normal as well as fully deuterated molecules are in agreement with the dimensions  $r(C=C) =$

1.344 Å  $r(\text{C}-\text{C}) = 1.465$  Å and  $\angle (\text{C}=\text{C}-\text{C}) = 123^\circ$ .

Butatriene ( $\text{H}_2\text{C}=\text{C}=\text{C}=\text{CH}_2$ ) is of interest because the central  $\text{C}=\text{C}$  bond has a different environment to the  $\text{C}=\text{C}$  bonds in ethylene or allene. On the basis of the Raman data<sup>13</sup> and assumed dimensions for the  $\text{C}=\text{CH}_2$  and groups (same dimensions as in allene) a length of 1.284 Å was obtained for the central  $\text{C}=\text{C}$  bond of butatriene. This value is in good agreement with the length found by electron diffraction in carbon suboxide ( $\text{O}=\text{C}=\text{C}=\text{C}=\text{O}$ ) where the  $\text{C}=\text{C}$  bonds are similarly adjacent to double bonds, but an independent determination of the central  $\text{C}=\text{C}$  bond in butatriene is desirable.

Only for ethylene does the appearance of the spectrum deviate markedly from the simple rotational structure observed for symmetric top molecules. The ethylene molecule ( $\text{H}_2\text{C}=\text{CH}_2$ ) is favourable in this respect since it is relatively light and the main series of lines (R and S branches) therefore have a larger spacing than in the spectra discussed earlier. In addition to the R and S lines ( $\Delta K=0$ ;  $\Delta J=1, 2$ ) which can be interpreted on the symmetric top approximation, a series of lines with smaller spacings than the S lines was observed (Romanko, Feldman, Stansbury and McKellar<sup>14</sup>). It was possible to explain this additional series on the basis of the asymmetric-top theory and to determine a value for the rotational constant  $C_0 = 0.8289 \text{ cm.}^{-1}$ . As before, the R and S branches were used to evaluate  $\frac{1}{2}(B_0 + C_0)$ . While an improvement in these values may be possible from the spectrum recently photographed with the 21 ft. grating showing much finer detail (Fig. 2g), it should be noted that the earlier Raman investigation<sup>14</sup> was the first time that evidence of deviation from the symmetric top structure of ethylene has been obtained from its spectrum, and the results have stimulated a re-examination of the infrared spectrum of ethylene at high resolution.

The values of carbon-carbon distances obtained from rotational Raman spectra confirm and extend the data obtained by microwave and infrared spectra, and by recent accurate X-ray and electron diffraction investigations of similar molecules. From a compilation of accurate data it has been found<sup>15</sup> that the lengths of carbon-carbon single bonds are dependent on the type of adjacent bonds. A similar dependence is also proposed for carbon-carbon double bonds although not as many accurate data are avail-

able as for the single bonds. A summary of bond lengths (in Å) is given here:

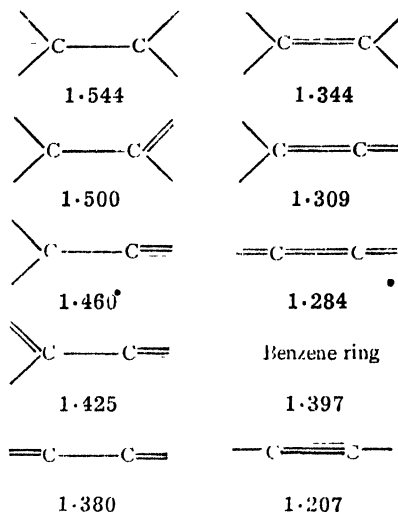

The above values seem to be surprisingly independent (within  $\pm 0.005$  Å) of whether C, H, N, O or S atoms are adjacent to the carbons, and can therefore be used with some assurance in predicting the structure of molecules with these atoms, in the gas phase.

In spite of the difficulties already mentioned in photographing rotation-vibrational Raman bands at high resolution the spectra of  $\text{C}_2\text{H}_2$ ,<sup>16</sup>  $\text{C}_2\text{D}_2$ ,<sup>17</sup>  $\text{C}_2\text{H}_4$ ,<sup>18</sup>  $\text{C}_2\text{H}_6$ ,<sup>19</sup>  $\text{C}_3\text{H}_6$ ,<sup>20</sup>  $\text{CO}_2$ ,  $\text{CS}_2$ ,<sup>21</sup>  $\text{CH}_4$ ,<sup>22,23</sup> and  $\text{NH}_3$ ,<sup>24</sup> have been investigated. Considerable detail has been observed in each spectrum including extensive rotational structure for many of the bands. In a general way, each investigation has yielded new and worthwhile results, in some instances even when no rotational structure was observed.

Although no rotational structure was resolved in the spectrum of cyclopropane,  $\text{C}_3\text{H}_6$ , the intensity contours of the bands were of great value in making vibrational assignments. In fact the intensity contours of Raman bands of gases are probably better criteria for such assignments than the frequently used depolarization factors. Another example is the spectrum of carbon disulphide  $\text{CS}_2$ , where the sharp Q branches of the Fermi diad  $\nu_1, 2\nu_2$  were observed as well as those of nine "hot" bands. These data have led to an evaluation of the effects of Fermi resonance and to the determination of a set of vibrational and anharmonic constants for  $\text{CS}_2$ .

For those bands where rotational structure was observed, the vibrational assignments were

unambiguous and the analyses gave band origins and rotational constants. For some bands, particularly in methane and ethane, the analyses also gave values of the Coriolis coupling constants.

The investigation of the ethane spectrum, by Romanko, Feldman and Welsh<sup>19</sup> appears to have solved the long outstanding problem of the equilibrium configuration of ethane. The problem is to determine whether ethane has the eclipsed configuration (point group  $D_{3h}$ ) or the staggered configuration (point group  $D_{3d}$ ). An unequivocal decision can be made if the rotational structure in the Raman spectrum of any one of the doubly degenerate bands  $\nu_{10}$ ,  $\nu_{11}$  or  $\nu_{12}$  is resolved: For the eclipsed model the selection rules for the quantum number  $K$  are  $\Delta K = \pm 1$ , while for the staggered model  $\Delta K = \pm 1, \pm 2$ . The band  $\nu_{12}$  has not been observed, and  $\nu_{11}$  has complications due to Coriolis interactions. However, the band  $\nu_{10}$  consists of a series of widely spaced lines which are definitely shown to be due to transitions  $\Delta K = \pm 2$  and this result establishes the staggered configuration ( $D_{3d}$ ) for ethane.

The  $\nu_2$  and  $\nu_3$  Raman and infrared bands of methane are seriously complicated by Coriolis interactions. The Raman spectra have yielded considerably more detail than the infrared spectra and some success in analysing them has been achieved. Values of band origins and rotational constants have been obtained but of more importance is the fact that the Raman results have to some extent helped in the analysis and understanding of some of the complex features in the infrared spectra. In the triply degenerate vibrational level,  $\nu_3$ , Coriolis coupling splits each rotational level into three. The Raman selection rules are  $\Delta J = 0, \pm 1, \pm 2$  for transitions to each of the three rotational levels and therefore 15 branches are predicted, and all have been observed. The infrared selection rules are  $\Delta J = 0, \pm 1$ , but the transitions are restricted so that only three branches without a common upper level are predicted. These three branches have been observed many times but always accompanied by a series of weak lines which have not been explained. When the frequencies of these extra lines were compared with the Raman frequencies many coincidences were found. There seems to be no doubt that the lines belong to the  $\nu_3$  band and that the restricted infrared selection rules are not valid. Similarly, the Raman spectrum of the doubly

degenerate  $\nu_2$  vibration<sup>23</sup> shows that Coriolis interaction with the nearby level  $\nu_4$  splits the rotational levels of  $\nu_2$  into two sets. Transitions with  $\Delta J = 0, \pm 1$  terminate in one set and transitions with  $\Delta J = \pm 2$  terminate in the other. From this analysis it was found that the doublet pattern of the infrared spectrum arises from transitions  $\Delta J = 0, \pm 1$  to each set of upper levels. Detailed theoretical explanations of these features in the  $\nu_2$  and  $\nu_3$  bands of methane have not yet been given.

These investigations have shown that valuable information of molecular structures can be obtained from the Raman spectra of gases photographed at high resolution. One may confidently expect that further work in this field will lead to other important results and to a more complete understanding of molecular spectra and molecular structures.

1. Welsh, Crawford, Thomas and Love, *Can. J. Phys.*, 1952, **30**, 577.
2. Stoicheff, B. P., *Ibid.*, 1954, **32**, 330.
3. Welsh, H. L., Cumming, C. and Stansbury, E. J., *J. Opt. Soc. Am.*, 1951, **41**, 712.
4. Welsh, Stansbury, Romanko and Feldman, *Ibid.*, 1955, **45**, 338.
5. Stoicheff, B. P., *Can. J. Phys.*, 1957, **35**, 730.
6. Andrychuk, D., *Ibid.*, 1951, **29**, 151.
7. Stoicheff, B. P., *Ibid.*, 1954, **32**, 339.
8. Cox, E. G. and Smith, J. A. S., *Nature*, 1954, **173**, 75.
9. —, Cruickshank, D. W. J. and Smith, J. A. S., *Ibid.*, 1955, **175**, 766.
10. Lancaster, J. E. and Stoicheff, B. P., *Can. J. Phys.*, 1956, **34**, 1016.
11. Stoicheff, B. P., *Ibid.*, 1955, **33**, 811.
12. Callomon, J. H. and Stoicheff, B. P., *Ibid.*, 1957, **35**, 373.
13. Stoicheff, B. P., *Ibid.*, 1957, **35**, 837.
14. Romanko, Feldman, Stansbury and McKellar, *Ibid.*, 1954, **32**, 735.
15. Herzberg, G. and Stoicheff, B. P., *Nature*, 1955, **175**, 79.
16. Feldman, T., Shepherd, G. G. and Welsh, H. L., *Can. J. Phys.*, 1956, **34**, 1425.
17. Krause, L. and Welsh, H. L., *Ibid.*, 1956, **34**, 1431.
18. Feldman, T., Romanko, J. and Welsh, H. L., *Ibid.*, 1956, **34**, 737.
19. Romanko, J., Feldman, T. and Welsh, H. L., *Ibid.*, 1955, **33**, 588.
20. Mathai, P. M., Shepherd, G. G. and Welsh, H. L., *Ibid.*, 1956, **34**, 1448.
21. Stoicheff, B. P., *Ibid.* (in press).
22. Stoicheff, Cumming, St. John and Welsh, *J. Chem. Phys.*, 1952, **20**, 498.
23. Feldman, T., Romanko, J. and Welsh, H. L., *Can. J. Phys.*, 1955, **33**, 138.
24. Cumming, C. and Welsh, H. L., *J. Chem. Phys.*, 1953, **21**, 1119.

## THE INDIAN ACADEMY OF SCIENCES

**A**T the invitation of Sri Venkateswara University, the Indian Academy of Sciences met at Tirupati on the 28th, the 29th and the 30th of December 1957, under the Presidency of Professor Sir C. V. Raman, F.R.S., N.L. Two symposia were held, one on "Geophysics" and the other on "Rice". The former is of special topical interest and the latter a vital subject in view of the existing food situation in India.

In his Presidential Address, Professor C. V. Raman outlined a new approach to the interpretation of the chemical behaviour of carbon. The quadrivalency of carbon and the equivalence of its four valences compel us to recognize that the quartet of valence electrons assumes a configuration exhibiting tetrahedral symmetry. The four axes of the tetrahedron have to be identified with the axes of the orbital angular momentum of each of the four electrons. The four orbits have to be similar and hence have to be described in the same sense. We have, therefore, two possible distinct states of the carbon atom, from which again, the existence of two distinct types of diamond exhibiting respectively tetrahedral and octahedral symmetry of structure follows as a natural consequence.

The Symposium on Geophysics was opened by Dr. S. Bhagavantam who spoke on the earth's crust. He indicated how the measurements of sound wave velocities reveal the structure of the interior of the earth. He further discussed the behaviour of rocks at high pressures as existing in the interior of the earth and suggested a plausible mechanism of earthquakes and rock-bursts wherein an enormous amount of deformation energy is released when a shearing stress acts on highly compressed rocks and how this can be understood from the third-order elasticity theory.

Dr. G. N. Ramachandran spoke on the theory of gravitation. He indicated in his talk how, by starting from the special theory of relativity as a basis and introducing a term in the equations of motion of a particle dependent on its velocity transverse to the direction of the field, it is possible to derive with certain modifications, the principal consequences of Einstein's gravitation theory, *viz.*, the precession of the orbit of the planet Mercury, the deflection of light in a gravitational field and the red shift of the spectral frequencies.

Dr. K. R. Ramanathan, President of the Xith General Assembly of the International Union of Geodesy and Geophysics for the Toronto Meeting, in his speech covered a wide field of activity. He referred to several important aspects of the physics of the earth. He discussed seismology, earth's magnetism and radioactivity with reference to heat flow from the earth and the earth's atmosphere. Under the upper air phenomena he dealt at length with auroræ, ionosphere and ionospheric disturbances and whistlers.

Dr. Vikram Sarabhai spoke on the solar and terrestrial relationships confining himself mainly to the dependence of cosmic ray intensity on the solar activity.

Dr. Rode spoke on the "Evolution of Southern Oceans".

Professor B. S. Madhava Rao gave a survey of the important applications of the Lorentz group in physical problems, especially in the field of elementary particles. He dealt at length with the recent work of Lee and Yang on the non-conservation of parity laws in the so-called weak interactions and its impact on several of the conservation laws of physics.

Dr. M. V. Govindaswamy spoke on "Research in Mental Disorders in India".

The Symposium on Rice was opened by Dr. K. Ramiah who outlined the problems and means of increasing production of rice, the chief methods available to increase acre yield being (i) improvement of water facilities, (ii) improvement of varieties by breeding, (iii) improvement of the natural fertility of the soil, (iv) improvement of cultivation practices, and (v) prevention of losses due to pests and diseases. He was followed by a number of other speakers who dealt at length with the different aspects of improvement of rice varieties by breeding with special reference to crosses, soil fertility and soil improvement by application of manures and fertilisers and methods of eliminating paddy pests by careful use of insecticides and fungicides, etc., etc.

Other papers of physical and chemical interest were read and discussed. Two popular lectures were delivered, one on "The Nature of Cells", by Dr. B. R. Seshachar and another on "The Raman Effect", by Dr. S. Bhagavantam.



## SOME RECENT SOVIET WORK ON CRYSTAL PHYSICS

R. F. S. HEARMON\*

**D**URING recent years, the volume of published Soviet work in physics has increased considerably. The established journals have tended to become larger, and several new journals have appeared. An appreciable fraction of this output has been devoted to various aspects of crystal physics, and this article summarizes some of the work. X-ray and electron diffraction investigations are excluded, as is also much of the work on barium titanate and allied piezoceramics; a review of early investigations on the latter subject was given by Hausner,<sup>1</sup> and more recent work has been dealt with by Smolenskiĭ,<sup>2</sup> who has correlated the Russian results with those of workers in other countries.

The majority of references given at the end are to work published after 1952-53; a review of earlier Soviet work on crystallography, including crystal physics, has been given by Mackay.<sup>3</sup>

## ELECTICAL AND MAGNETIC PROPERTIES

Zheludev<sup>4</sup> has dealt with the fundamentals of the dielectric properties of crystals, including their representation by ellipsoids, together with the associated radius normal property. Electric strength has also been considered<sup>5</sup> experimentally in relation to crystallographic orientation, and theoretically in relation to mechanical and thermal stability and the lattice energy. Experimental results have also been given for the temperature dependence of dielectric constant in NaCl<sup>6</sup>; for dielectric losses in alkali halides as affected by frequency and temperature,<sup>7</sup> and for the dependence of electrical conductivity in quartz on temperature and on the electric and magnetic fields.<sup>8</sup> Work on magnetism has included the theory of magnetic symmetry<sup>9</sup>; magnetostriction in nickel<sup>10</sup>; and the anisotropy of magnetic properties in zinc single crystals.<sup>11</sup>

## PIEZOELECTRIC AND FERROELECTRIC PHENOMENA

In 1955, a conference on piezoelectricity was held in Moscow, and the papers presented, numbering 15 altogether, were published early in 1956.<sup>12</sup> The papers dealt with: barium titanate and other piezoceramics; new piezoelectric crystals; piezoelectric properties of wood and cellulose materials; physical properties and domain structure of Rochelle salt, including the effect of impurities and exposure to

gamma radiation; the theory of piezoelectric resonators and the use of defective crystals for the production of oscillator plates.<sup>13</sup> Methods have been investigated<sup>14</sup> for growing crystals of ethylene diamine tartrate, lithium sulphate and potassium tartrate; and instruments described<sup>15</sup> utilising piezoelectric crystals for measuring the pressure of explosions in gaseous mixtures and the stresses in intermittently acting mechanisms. In addition to the work on wood mentioned above, studies have been made of the piezoelectric effect in rocks.<sup>16</sup> Electrets in carnauba wax, and photoelectrets in sulphur single crystal have also been investigated.<sup>17</sup>

The properties of Rochelle salt and other ferroelectric materials have received much attention. In strong 50 c/s. fields it appears<sup>18</sup> that ferroelectric properties in Rochelle salt persist above 24°C., normally taken as the upper Curie point. The index of refraction shows no discontinuity at the upper Curie point,<sup>19</sup> and on exposure to gamma rays from Co 60, the ferroelectric behaviour becomes less marked and ultimately disappears.<sup>20</sup> The effect of impurities on dielectric constant, piezoelectric modulus, crystal habit and domain structure have been studied.<sup>21</sup> Zheludev and Shuvailov<sup>22</sup> list the crystal symmetries of possible ferroelectric phases corresponding with a given symmetry and direction in the initial phase. The domain structure of Rochelle salt has been examined optically, and by a technique involving micro-cinematography.<sup>23</sup> The latter technique has also been used to follow phase transitions and domain structure in barium titanate<sup>25</sup> and the behaviour of spiral centres and dislocations during crystal growth.<sup>26</sup>

## ELASTIC AND ALLIED PROPERTIES

Values of the elastic constants of  $\alpha$ - and  $\beta$ -quartz, NaCl, AgCl and ammonium dihydrogen phosphate (ADP) have been published, and, except for ADP, the variation with temperature is also given.<sup>27</sup> Three different techniques were involved: a composite oscillator was used for NaCl and AgCl; the Schaefer-Bergmann method for  $\alpha$ - and  $\beta$ -quartz; and for ADP, the method involved comparing the transmission velocity through the material with that through a known liquid.

Zubov and Firsova<sup>28</sup> have reported measurements on quartz at 20°C., obtained by the Schaefer-Bergmann method. They observed some inconsistencies in the results which they

\* Princes Risborough, Bucks, England.

interpret as supporting the theory of Laval and Raman-Viswanathan, according to which the number of independent elastic constants needed to specify the behaviour of a completely asymmetric material is 45, instead of the 21 required according to the classical theory of Voigt; in quartz, the corresponding numbers are 10 and 6.

Aleksandrov<sup>29</sup> has dealt theoretically and experimentally with the analogy between the propagation of ultrasonic waves and light in crystals; various aspects of this analogy had previously been brought out by other workers. For an arbitrary direction of wave propagation in an anisotropic material, there are three independent waves, the displacement directions in each being mutually perpendicular. In general, these directions are neither coincident with, nor perpendicular to the direction of propagation, and the vibrations are therefore *quasi*-longitudinal or *quasi*-transverse. In certain special directions, however, the waves are purely longitudinal and purely transverse, and, following Borgnis, Aleksandrov has worked out the special directions for a material of orthorhombic symmetry, and from these results has deduced the special directions in tetragonal, hexagonal, and cubic materials. Aleksandrov has demonstrated experimentally the existence of polarisation effects with ultrasonic waves, and has discussed the possibility of double refraction and internal conical refraction. All these effects have, in fact, been observed previously, but another effect mentioned by Aleksandrov, the possibility of using a quarter wave plate of quartz to produce circularly polarised vibrations, has not.

Some of the recent work has dealt theoretically with thermal stresses in anisotropic bodies belonging to different crystal classes,<sup>30</sup> and with the fundamentals of the strength of anisotropic materials.<sup>31</sup> The formation and structure of "kink-bands", and their relationship to crystal orientation and state of stress in ionic crystals have been investigated<sup>32</sup>; the application of photoelastic methods to the study of stress distribution in anisotropic systems has also been suggested.<sup>33</sup>

#### THERMAL PROPERTIES

Values of the thermal expansion coefficients as measured by X-ray methods have been re-reported<sup>34</sup>; theoretical analyses have been made of problems in thermal expansion and conduction<sup>35</sup>; and relationships between the expansion and conduction coefficients have been examined.<sup>36</sup> Shubnikov<sup>37</sup> has discussed some fundamental points connected with the thermal ex-

pansion of crystals; he has emphasised the importance of the thermal shear deformation which occurs in many crystal classes and has illustrated diagrammatically the thermal deformation surfaces corresponding with different relative values of the principal thermal expansion coefficients of single crystals.

#### REFERENCES

The references below are believed to include the majority of important papers published in the last few years, but the coverage is not exhaustive. The journals most frequently referred to are denoted by single letter abbreviations. Complete translations of *D.*, *E.*, *I.* and *T.* are available from 1956 onwards; translated titles are given in "Translated Contents Lists of Russian Periodicals", prepared by the Department of Scientific and Industrial Research, and published by Her Majesty's Stationery Office, London. The following list gives: (1) Name of Journal, (2) Single letter abbreviation, (3) Title of translation, (4) Translating authority.

(1) *Dokl. Akad. Nauk SSSR.* (2) *D.* (3) Soviet Physics-Doklady. (4) American Institute of Physics.

(1) *Zh. éksper. teor. Fiz.* (2) *E.* (3) Soviet Physics-JETP. (4) American Institute of Physics.

(1) *Izv. Akad. Nauk SSSR. Ser. Fiz.* (2) *I.* (3) Bulletin of the Academy of Sciences, USSR, Physics Series. (4) Columbia Technical Translations.

(1) *Kristallografiya.* (2) *K.* (3) and (4) Not translated.

(1) *Zh. tekh. Fiz.* (2) *T.* (3) Soviet Physics-Technical Physics. (4) American Institute of Physics.

The American Institute of Physics also issues a translation of "Akusticheskiĭ Zhurnal" as "Soviet Physics-Acoustics".

1. Hausner, H. H., *Ceramic Age*, 1947, **50**, 162.
2. Smolenskiĭ, G. A., *Z.*, 1957, **21**, 233.
3. Mackay, A. L., *Newo Cim.*, 1953, **10**, *Supp.*, 387.
4. Zheludev, I. S., *K.*, 1956, **1**, 105.
5. Vorob'ev, A. A., *D.*, 1952, **86**, 681 (orientation); *T.*, 1956, **26**, 327, 330.
6. Chmutin, M. S., *E.*, 1954, **26**, 640.
7. Vorob'ev, A. A. and Vodop'yanov, K. A., *D.*, 1954, **94**, 429; Matsonashvili, B. N., *E.*, 1956, **31**, 1110.
8. Satzhevskiĭ, P. E., *D.*, 1952, **82**, 571.
9. Tavger, B. A. and Zaĭtsev, V. M., *E.*, 1956, **30**, 564.
10. Akulov, N. S., *D.*, 1956, **106**, 31.
11. Verkin, B. I. and Dmitrenko, I. M., *I.*, 1955, **19**, 409.
12. *I.*, 1956, **20** (2).
13. Yaroslavskii, M. I. and Vasin, I. G., *K.*, 1956, **1**, 603.

14. Pozdnyakov, P. G., *K.*, 1956, **1**, 228, 356, 589.
15. Zheludev, I. S. and Ojievich, I. V., *Trudy Inst. Krist. Akad. Nauk SSSR*, 1956, No. 12, 200; — and Makarov, V. M., *K.*, 1956, **1**, 370.
16. Volarovich, M. P. and Parkhomenko, E. I., *D.*, 1954, **99**, 239; *Izv. Akad. Nauk SSSR, Ser. Geofiz.*, 1955, **18**, 215.
17. Frohman, A. I. and Fridkin, V. M., *K.*, 1956, **1**, 342; Fridkin, V. M., *K.*, 1956, **1**, 557, 692.
18. Kosman, M. S. and Snevordin, A. N., *T.*, 1956, **26**, 1443.
19. Baranskiy, K. N., Gilbov, L. A. and Prikhod'ko, V. P., *K.*, 1956, **1**, 368.
20. Yunin, V. A., *K.*, 1956, **1**, 734.
21. Chornomonov, T. Kh., *T.*, 1956, **26**, 323.
22. Zheludev, I. S. and Shul'ov, L. A., *K.*, 1956, **1**, 681.
23. Chernysheva, M. A., *I.*, 1957, **21**, 289.
24. Zheludev, I. S. and Sit'ko, R. Ya., *K.*, 1956, **1**, 689.
25. — and Parvov, V. F., *K.*, 1956, **1**, 462.
26. L'vovskiy, G. G. and Dukova, E. D., *K.*, 1956, **1**, 351, 477.
27. Zubov, V. G., *D.*, 1956, **107**, 392 ( $\alpha$ -quartz); —, and Firsova, M. M., *D.*, 1956, **109**, 493 ( $\beta$ -quartz); Stepanov, A. V. and Elyas, I. M., *E.*, 1955, **29**, 669 (NaCl and AgCl); Aleksandrov, K. S. and Nosikov, O. V., *Akust. Zh.*, 1956, **2**, 244 (ADP).
28. Zubov, V. G. and Firsova, M. M., *K.*, 1956, **1**, 546.
29. Aleksandrov, K. S., *K.*, 1956, **1**, 138, 718; — and Khaimov-Mal'kov, V. Ya., *K.*, 1956, **1**, 373.
30. Grechushnikov, B. N. and Brodovskiy, D., *K.*, 1956, **1**, 597; Indenbom, V. L., Silvestrova, I. M. and Sirotin, Yu. I., *K.*, 1956, **1**, 599; Sirotin, Yu. I., *K.*, 1955, **1**, 708.
31. Belov, N. V. and Klassen-Neklyudova, M. V., *T.*, 1948, **18**, 265; Stepanov, A. V., *I.*, 1953, **17**, 271; *Izv. Akad. Nauk SSSR, Otdel. Tekh. Nauk*, 1954 **18** (9), 9 (Translation in *Research*, 1955, **9**, 227); Fridman, Ya., B. and Sobolev, N. D., *D.*, 1956, **106**, 611.
32. Kolontsova, E. V., Telegina, I. V. and Plavnik, G. M., *K.*, 1956, **1**, 419; Klassen-Neklyudova, M. V. and Urusovskaya, A. A., *K.*, 1956, **1**, 410, 564.
33. Krasinov, V. M. and Stepanov, A. V., *E.*, 1953, **25**, 98; Zhitniko, R. A. and Stepanov, A. V., *T.*, 1956, **26**, 772, 779, 786; Stepanov, A. V. and Bozhikov, V. P., *T.*, 1956, **26**, 795.
34. Sauka, Ya., *Zh. fiz. Khim.*, 1951, **25**, 41 (lead fluoride); Kozhin, V. M. and Kitaigorodskiy, A. I., *Ibid.*, 1953, **27**, 534, 1676 (naphthalene) and anthracene); Zubeiko, V. V., and Umanskiy, M. M., *K.*, 1956, **1**, 436 (aluminium and bismut); Shal'nikova, N. A. and Yakovlev, I. A., *K.*, 1956, **1**, 531 (sapphire and ruby).
35. Mitskevich, N. V., *E.*, 1954, **26**, 557; Shmarts, V. I., *E.*, 1954, **27**, 62.
36. Zhuze, V. P., *D.*, 1954, **99**, 711; Kontorova, T. A., *T.*, 1956, **26**, 2021.
37. Shubnikov, A. V., *K.*, 1956, **1**, 95.

### LIGHTNING SHOCK

**A** DIRECT HIT by a lightning flash or a high-voltage electric current is almost invariably fatal. Massive holes and tears are found in the body, especially in the brain and blood vessels. But most people apparently struck by lightning seem to suffer no more than freakish damage to parts of their clothes and body. This is because the current tends to take the pathway of lowest resistance; it leaps from one low resistance conductor to another, so that down this pathway all the energy is dissipated, leaving organs a few centimetres away unharmed. The main resistance offered by the body is in the dry skin, and that is why household electric currents are so much more dangerous to the wet body. Surprisingly, the pathways followed by such currents as do traverse the body are not yet finally settled. It is thought that the energy goes mainly along blood vessels or nerves and it is considered that the whole body is a low resistance, structureless gel, so that there is a steady potential drop along the shortest line between the points of entry and exit of the current, with uniform potential fields around. When the current passes from one hand to the other it traverses the lower cervical spinal cord, which may explain why the results of this accident often took like transverse myelitis or even disseminated sclerosis. Whatever the pathways taken, it is

the nervous system that always seems to bear the brunt of the current, though experimentally large currents can make the heart stop or fibrillate. A condition of profound "shock" with apparent suppression of all nervous activity may last one or two hours after a heavy electrical shock, yet the persons still recover without apparent sequelæ.

The changes seen in the body after an electric shock depend in the first place and most importantly on the physical characteristics of the current applied, especially on voltage. Of secondary importance is the pathway of the current—its points of entry and exit—and how great a potential gradient is produced inside the body once the high resistance of the skin has been broken down. The brain seems to be the most sensitive organ, but its functions are more often temporarily suspended than destroyed or permanently modified. For this reason it has always been recommended that prolonged artificial respiration be given to those apparently dead from electric shock or lightning. However, a careful physical examination is also necessary, since other potentially fatal lesions such as skull fractures may result from the patient being hurled on to the ground or on to other hard objects by the force of the current. (*B.M.J.*, Nov. 16, 1957.)

## ELEVENTH GENERAL ASSEMBLY OF INTERNATIONAL UNION OF GEODESY AND GEOPHYSICS

**T**HE Eleventh General Assembly of the International Union of Geodesy and Geophysics which was held in Toronto, Canada, during September 3-14, 1957, is of particular interest to India as, for the first time in the history of the Union, it had elected to its Presidency a distinguished scientist of India—Professor K. R. Ramanathan, Director of the Physical Research Laboratories, Ahmedabad. Besides, the Toronto Assembly was held during the International Geophysical Year in which several Indian organizations are participating.

The Assembly, in which about 1,500 delegates from 50 countries participated, was formally inaugurated on September 3rd, by Mr. John Diefenbaker, Prime Minister of Canada. Professor Ramanathan, in his Presidential Address, reviewed the progress of the Union during 1954-57, and summarized recent trends in geophysical research in the fields of Geomagnetism, Atmospheric Physics, Cosmic Rays and Solar Activity.

The Constituent Associations of the Union held their sessions during September 4-13. The Association of Seismology and the Physics of the Interior of the Earth, under the Chairmanship of Prof. K. E. Bullen, organized discussions and symposia in the following subjects: Earthquake Magnitude and Energy, Crustal Structure of Continents and Ocean Basins, Travel Times and Velocities of Earthquake Waves and the Internal Structure of the Earth, Conditions at the Foci of Earthquakes with Special Reference to Fault Planes and Seismic Studies in the Arctic and Antarctic. The participants included many eminent scientists including Professors Gutenberg, Press and Birch of U.S.A., Jeffreys and Bullard of U.K., Belousov of U.S.S.R., Tsuboi of Japan and Tuzo Wilson of Canada. The proposal of Prof. Bullen to request the Nuclear Powers to detonate a few A-Bombs at appropriate places and pre-arranged times so as to help the study of the earth's interior was strongly opposed by the Russian delegation on the ground that "it is not necessary (for this purpose) to do such a thing as exploding the Bombs". Dr. Vladimir Belousov, Chief of the Department of Geodynamics, Institute of the Physics of the Earth, Moscow, who made the statement believes that improvement in the precision of the techniques currently employed will be equally effective.

The highlights of the proceedings of the Association of Volcanology were the Presidential Address of Prof. A. Rittman of Switzerland

on magma, crust and substratum and the symposium on Geochronology and Radioactivity organized jointly with the Association of Seismology, in which prominent research workers in Geochronology from all over the world participated.

Professor Rossby of Sweden was scheduled to preside over the Sessions of the Association of Meteorology but unfortunately he passed away shortly before the Conference. The proceedings were conducted by Dr. J. M. van Mieghem. There were well-attended symposia on "Numerical and Graphical Methods of Dynamical Weather Prediction", on "Atmospheric Turbulance", "Atmospheric Chemistry and Air Pollution", "Meso-meteorology", "Atmospheric Ozone and Related Problems of the Upper Atmosphere", and "Atmospheric Electricity". The last two were organised jointly with the Association of Geomagnetism and Aeronomy.

The Association of Geomagnetism and Aeronomy conducted its proceedings under the Chairmanship of Professor J. Bartels of Germany. A comprehensive and a very successful three-day symposium on Aeronomy and Solar-Terrestrial relationships was arranged by Prof. J. Kaplan. There was also an excellent symposium on "Secular Variation and Paleomagnetism" organised by Prof. Bullard. Paleomagnetic results from India, and especially data relating to the Deccan traps, were discussed by Mr. J. A. Clegg and E. R. Deutsch.

The Association of Physical Oceanography met under the Chairmanship of Professor H. Mosby of Norway. Symposia were arranged on the following topics: Water Balance (jointly with the Associations of Meteorology and Hydrology), General Circulation of the Ocean with Particular Emphasis on Deep Water Movements, Construction of Cotidal Charts, Carbon dioxide Cycle in the Atmosphere and Ocean, Currents and Tidal Streams near the Bottom in Coastal Waters and Estuaries, and Transfer of Momentum from the Air to the Sea. Papers on Physical Oceanographic Studies in the Bay of Bengal, Arabian Sea and Indian Ocean were submitted by Drs. La Fond, Nanca, Ramanadham, and Balaramamurthy, Drs. Dodson and Revelle presided over some of the Sessions of the Association.

Professor J. T. Thijsse of Netherlands gave the Presidential Address to the Association of Scientific Hydrology. Discussions were held

on Problems of Ice and Snow, Subterranean Waters and Continental Erosion.

Two well-attended public lectures on the following topics were organized in connection with the I.U.G.G. Conference: "The Arctic and Antarctic Program of the I.G.Y.", by Dr. E. I. Tolstikov, Deputy Chief of the Northern Sea-Route Administrations of U.S.S.R., and "The Earth Satellites", by Prof. L. V. Berkner, President of the International Council of Scientific Unions.

The generous Canadian hosts had worked out an excellent programme of visits and entertainments, designed to acquaint the visiting scientists with the natural beauty spots around Toronto.

The Toronto Assembly of the I.U.G.G. con-

cluded its deliberations on September 14th. Dedicating itself, in the words of President Ramanathan, to *Sathyam* (Truth), *Jnanam* (Knowledge), *Anantham* (Without end). It was officially announced that Professor J. T. Wilson of Canada had been elected as the next President. The Twelfth General Assembly will be held in Helsinki, Finland, in 1960.

The Indian delegation was composed of Prof. K. R. Ramanathan, Director, Physical Research Laboratory, Ahmedabad, and Dr. U. Aswathanarayana, Andhra University, Waltair. The following Indian Research Fellows working in Canada joined as guests: Drs. S. C. Das, R. Pratap, M. V. N. Murthy, A. K. Saha and Mr. Agarwal.

U. ASWATHANARAYANA.

---

### PREPARATION OF NOBELIUM

**T**HE new element was synthesized by the fusion of an atom of the heavy isotope of carbon, carbon-13, with an atom of curium (element 96). In order to obtain the most stable product, it was necessary to use the heaviest available isotope of curium. This is curium-244, and it was only available in the United States as a product of irradiating plutonium with neutrons in the world's highest flux reactor.

Great Britain provided considerable quantities of carbon-13 required, from Harwell and the Nobel Institute of Physics, Stockholm, provided the Cyclotron, the only one in the world capable of accelerating carbon ions with the required energy and intensity.

Due to the hazardous nature of the target material and the difficulty of separating a few atoms of the new element from it, a rather new bombardment technique was employed. This utilized the recoil or 'knock-on' effect. A thin layer of curium was deposited on an aluminium foil, and the product atoms knocked out of the target were collected in a plastic film after passing through a very thin aluminium cover foil placed over the curium target, to prevent the spread of curium contamination. The plastic film was ignited on a platinum disk to recover the product atoms. The decay of these atoms could be observed directly, or they could be dissolved off the plate for chemical identification.

A new alpha-activity of 8.5 MeV. energy was

observed among the products, and although only seventeen events of this energy were observed with certainty, it was possible to show that the new alpha-emitter had the expected chemical properties for an isotope of element 102. The chemical experiments in each case used ion-exchange techniques. When the activity was absorbed on a column of cation-exchange resin and washed off with a complexing agent (alpha-hydroxy isobutyric acid), the 8.5 MeV. alpha-activity appeared in the drops predicted for element 102.

There was a possibility that the activity might be due to thorium-225, which has a half-life of 8 min. and produces a short-lived daughter, polonium-213, which emits 8.4 MeV. alpha-particles. This was eliminated by eluting the activity from a cation-exchange column with 6N hydrochloric acid. Under these conditions, thorium is retained by the column, while the trivalent actinide elements are eluted rapidly. The 8.5 MeV. alpha-activity was found in the actinide fraction.

A graph showing the moment of decay of each of the seventeen atoms observed gave a half-life of about 10 min. for the new activity. The observed alpha-particle energy and half-life, the absence of spontaneous fission, and the method of preparation lead us to believe that the mass number of the isotope prepared is either 251 or 253, the latter number being more likely (*Nature*, Nov. 16, 1957.)

---

## A PRELIMINARY REPORT ON THE DETECTION OF ISOPROPYL-NORADRENALINE IN HUMAN URINE

SARADA SUBRAHMANYAM

*Head of the Department of Physiology, Stanley Medical College, Madras*

MARY F. LOCKETT (1954)<sup>1</sup> reported for the first time that a new sympathomimetic amine was unexpectedly encountered in an experiment in which adrenaline and noradrenaline were being separated chromatographically from the adrenal gland of cat. According to her the third amine is isopropyl-noradrenaline and it is found to be present in the adrenal glands of cat, monkey and man.

Garb *et al.* (1956)<sup>2</sup> commented that its discovery in the adrenal gland may be significant because of its high potency and it may be very useful in the management of cardiac arrest on account of its unique property of increasing the rate of the heart—a manifestation of enhanced automaticity.

The presence of isopropyl-noradrenaline in the urine has not been reported so far in the literature.

*Materials and Methods.*—Out of a total of 800 samples of urine analysed in this laboratory for catechol amines a profound fall of blood pressure was noticed in four cases.

Twenty-four hours samples of urine were collected from normal subjects and patients suffering from hypertension. The catechol amines were extracted by the method of Von Euler and Orwen (1955).<sup>3</sup> Adsorption of the catechol amines on to alumina and extraction with acid by this method usually gives a histamine-free extract. Further care was taken in all these cases to eliminate the fall of blood pressure by this mechanism by administering sufficient doses of antihistaminics prior to the experiments.

The extract was assayed biologically on the blood pressure of the spinal cat and by the effect on the not-denervated nictitating membrane of the same animal. The biological assays were carried out on three different cats with the same sample as well as by samples collected on different days.

The results were verified by paper chromatography using a modified method of Vogt (1952).<sup>4</sup> The solvent for the chromatogram was phenol containing 15% V/W 0.1 N hydrochloric acid and ascending chromatograms were run for 16 hours. By that time the solvent front invariably advanced to about 14" from the starting line. The spraying agent for oxidation of amines was 2% aqueous solution of

potassium iodate instead of potassium ferricyanide as used by Vogt. Chromatograms of three samples of urine and a reference mixture containing known concentrations of noradrenaline, adrenaline and isopropyl-noradrenaline (Isoprenaline-Boots) were made in parallel on a single sheet of paper. Quantitatively the amines from the developed chromatogram were estimated by the densitometer as well as by the effects of the extracts of the chromatograms by the biological methods. One sample was used for the determination of  $R_f$  values, the second for biological assay and the third for quantitative determination by the densitometer.

The identity of the third amine was also confirmed by the action of the urinary concentrate as well as of the chromatogram extract on the auricles of the cat and the isolated uterus of the virgin white rat. All the four samples of urine were from men, three of them having normal blood pressure. The other one was suffering from essential hypertension. The ages were 35, 36, 43 and 52 years and the blood pressure was 118/78, 115/80, 120/80 and 180/100 mm. of mercury respectively.

*Results.*—The urinary concentrate as well as the chromatogram extract gave the following results:

1. Both produced a profound fall in blood pressure with tachycardia in the spinal cat (Fig. 1).

2. Even after massive doses of anthisan intravenously the extracts produced the characteristic fall in blood pressure whereas an equivalent dose of histamine was without any effect (Fig. 2).

3. There was no contraction of the nictitating membrane of the cat (Fig. 1).

4. On the auricle of the cat, the extracts produced marked increase in the rate and amplitude of the contractions (Fig. 3).

5. The uterine contractions of the rat were promptly inhibited by the test solutions. The action was similar to that of adrenaline (Fig. 4).

6. On the paper the third amine appeared as a pale pink spot, exactly like isopropyl-noradrenaline. The  $R_f$  value varied between .69 to .71 in the four different samples. This spot was distinct from noradrenaline, adrenaline and hydroxy-tyramine (Fig. 5).

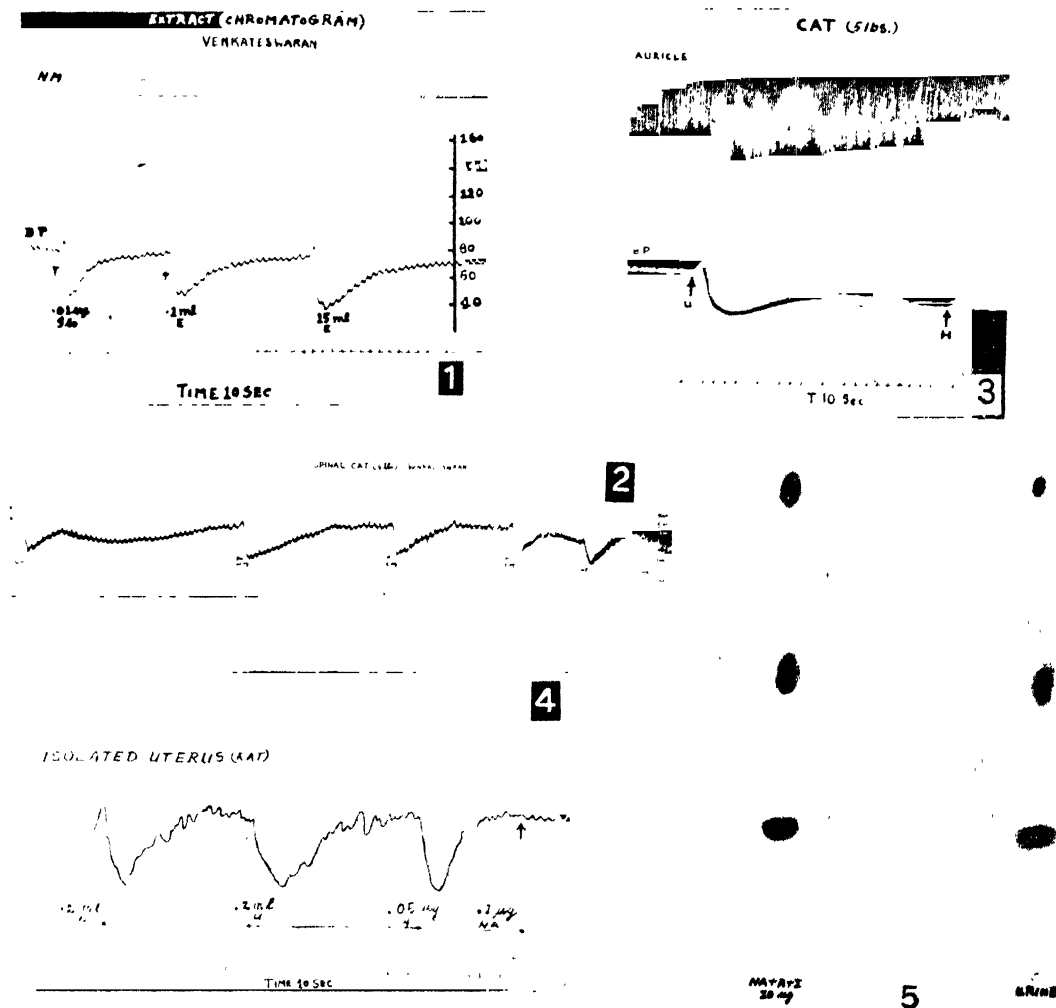

FIG. 1. Spinal cat. Effect of extract of chromatogram on nictitating membrane and blood pressure. 1. 0.01 mcg. isoprenaline. 2. 0.1 ml. extract. 3. 0.15 ml. extract. Time 10 seconds.

FIG. 2. Spinal cat. Effect of extract of urine on blood pressure. 1. 0.2 ml. urine. 2. 0.05 mcg. isoprenaline. 3. 0.5 mg. histamine. 4. 5 mg. anthisan. 5. 0.1 ml. urine. 6. 0.5 mg. histamine. Time 10 seconds.

FIG. 3. Spinal cat. Myocardiogram. Contractions of the auricles *in situ* and blood pressure. 5 mg. of anthisan had been given by intravenous injection prior to the experiments. 1. Extract of urine. 2. Histamine. Time 10 seconds.

FIG. 4. Isolated uterine horn of white rat. 1. 0.2 ml. urine extract. 2. Same as 1. 3. 0.05 mcg. adrenaline. 4. 0.1 mcg. noradrenaline. Time 10 seconds.

FIG. 5. Chromatogram of the extract of urine. 1. Reference mixture containing 10 mcg. each of noradrenaline, adrenaline and isoprenaline. 2. Extract of urine. (The lowest spot is noradrenaline, the middle one adrenaline and the topmost one isopropyl-noradrenaline.)

The amounts of isopropyl-noradrenaline in the four samples were as follows:

	By Biological Method	By Pencilometer
1	4.8 micrograms per day	5 micrograms per day
2	6.4 "	6.2 "
3	6.8 "	6.4 "
4	10.2 "	10.6 "

Von Euler (1954)<sup>5</sup> reported a case of phæochromocytoma in which the urinary extract produced a persistent fall of blood pressure in the cat. The reason for this peculiar reaction was not elucidated.

Out of 800 cases analysed in this Laboratory, four samples gave results which were analogous

with those of Von Euler. It is suggested that the fall in blood pressure is due to the presence of isopropyl-noradrenaline in the urine and it has been possible to prove that it is so both by biological assays and chromatography. The metabolism of this catechol amine and its rarity in urine specimens require further study.

My thanks are due to Dr. K. Madhavan Kutty

and Mr. C. P. Chamukuttan for the kind help rendered.

1. Mary F. Lockett, *Brit. J. Pharmacol.*, 1954, **9**, 498.
2. Solomon Garb, Mario Penna and Aaron Ganz, *Amer. J. Physiol.*, 1956, **135**, 332.
3. Von Euler, U.S. and Owen, I., *Acta Physiol. Scandinav.*, 1955, **33** (suppl. 118), 1.
4. Vogt, M., *Brit. J. Pharmacol.*, 1952, **7**, 325.
5. Von Euler, U.S., *CIBA. Foundation Symposium on Hypertension*, 1954, p. 202.

### ACCIDENT AT WINDSCALE

**A** REPORT on the accident at Windscale, published as a White Paper, shows that no harm to anyone's health is to be expected, though it points to certain shortcomings in the organization. An operation for the controlled release of Wigner energy, which is a routine procedure in uranium-graphite piles, was being carried out at the time the accident occurred. A standard pile consists of a large block of graphite somewhat larger than a house, with hundreds of cylindrical holes passing from one side to the other, parallel to the ground. Cartridges composed of uranium and uranium oxide contained in a case of aluminium zirconium alloy are inserted into the centre of the pile through the holes at one side, and, when expended, are pushed out from the other by fresh cartridges similarly inserted. The surrounding graphite is known as the moderator and slows down the neutrons emitted from the uranium to a suitable level. This results in some of the atoms of carbon becoming displaced from stable to unstable positions, thus increasing the internal energy of the graphite. E. P. Wigner postulated that this would occur, and the phenomenon is progressive and can result in a spontaneous release of energy. This occurred in the Windscale pile in 1952. Artificial heating of the graphite under controlled conditions causes a reversal of the Wigner effect, and this operation, which had been successfully accomplished on eight previous occasions, was in progress when the accident occurred.

Controlled release of stored Wigner energy is accomplished by shutting off the air-cooling systems which are normally in operation and allowing the temperature of pile to rise. The progress of the operation is assessed by observation of the temperatures which are recorded by thermocouples, but on this occasion, owing partly to lack of adequate knowledge of the Wigner effect at the time the pile was built, unduly high temperatures were being attained at points in the graphite where thermo-

couples were not installed. The physicist in charge of the operation, handicapped by insufficient data and inadequate instructions for the procedure, repeated the heating process too soon and too quickly, causing failure of the uranium cartridges and oxidation of the uranium. On October 9, it was realized that the graphite temperature readings were unusually high, and the cooler fans were turned on intermittently. Early on the next day meters in the chimney recorded increased radioactivity, but the levels were considered to be within normal limits. The fans were turned on again and again but the measured radioactivity increased. As a result of these observations, the operators concluded that one or more uranium cartridges had failed. Special apparatus is installed to assist in the detection of burst cartridges, but on this occasion the scanning gear was found to be jammed, although it had been recently repaired. It was necessary therefore to arrange for visual inspection through the pile face, and four channels revealed cartridges at red heat. Because the cartridges were distorted by the heat it was not possible to eject them in the normal way through the opposite face of the graphite pile, and the fire was therefore localized by removing a number of neighbouring cartridges. Carbon dioxide foam was applied but failed to reduce the temperature, and it was decided then to use water to quench the fire. This was begun at 8-55 a.m. on October 11, 1957, adequate measures having been taken to ensure the safety of the staff, and continued for 24 hours, at the end of which time the pile was cold. Although the Committee of Inquiry was unable to endorse the conclusion that the observed temperature recordings indicated the need for a second heating, it agreed that both the instrumentation in the pile and the instructions to the physicists were inadequate. The Atomic Energy Authority has accepted full responsibility for the accident and is determined to do all it can to avoid a similar occurrence elsewhere. (*B.M.J.*, Nov. 16, 1957.)



## LETTERS TO THE EDITOR

ANODIC REACTIONS IN THE  
ELECTROLYSIS OF ACID-COBALT-  
FLUORIDE

OF the various cations which lend themselves to oxidation anodically, a few like silver and lead form solid, insoluble, electrically conducting products on the anode. Cobalt has also been reported to form a hydrated cobaltic oxide anodically, in the electrolysis of slightly alkaline or slightly acid solutions of its salts.<sup>1,4</sup> It has been stated that the composition of the oxide conforms to  $\text{Co}_2\text{O}_3 \cdot 2\text{H}_2\text{O}$  when deposited in thin layers and  $\text{Co}_2\text{O}_3 \cdot 3\text{H}_2\text{O}$  when deposited in thick layers.<sup>3</sup>

The authors felt interested in the anodic reactions in the electrolysis of cobalt fluoride, following the discovery of the anodic formation of a higher oxide of silver,  $\text{AgO}_2$ , in the electrolysis of silver fluoride.<sup>5</sup> Skirrow<sup>2</sup> found only  $\text{Co}_2\text{O}_3 \cdot 3\text{H}_2\text{O}$  in the electrolysis of cobaltic salts containing some hydrofluoric acid. Barbieri and Calzolari,<sup>6</sup> electrolysing cobaltous fluoride dissolved in a 40% solution of hydrofluoric acid found a green anodic deposit of  $\text{CoF}_3 \cdot n\text{H}_2\text{O}$ . The hydrated cobaltic oxide prepared by earlier workers has always been described as black and crystalline. In confirmation of the findings of previous workers, the present authors have found that in the electrolysis of fluoride solutions also, the presence of too much of free acid is not favourable for the formation of cobaltic oxide. In a solution composed of 0.1216 M.  $\text{CoF}_2$  and 0.6224 M. HF, a mixture that was found suitable and stable for continuous electrolysis for the electrodeposition of cobalt, the anodic product was obtained in reasonable quantities. With lesser quantities of acid, current efficiency was higher and with a ratio of  $\text{CoF}_2/\text{HF}$  more than 10, no deposit was obtained.

Careful analysis of the black deposit for its water content, loss of weight on strong heating, determination of available oxygen and percentage of cobalt in the compound, prepared in almost neutral solutions and in acidic solutions, showed it to be  $\text{Co}_2\text{O}_3 \cdot 2\text{H}_2\text{O}$ . Even when thick deposits were obtained, we found no evidence for the formation of trihydrate reported by Cohen and Glaser.

The anodic reaction carried out under a variety of conditions does not appear, even in the electrolysis of fluoride, to go beyond oxidising cobalt to tervalent stage. The anode

discharge potentials in nearly neutral fluoride solutions in the bath mentioned above and in acid solutions in which  $\text{CoF}_2/\text{HF}$  exceeds 10, have been found to be 1.2 volt, 1.45 volt and 1.72 volt respectively. The authors have found that the anode discharge potentials in most of the metallic fluoride solutions happen to be in the neighbourhood of 1.72 volt and oxygen is invariably the product. In the cases of silver and cobalt, however, the discharge potentials are less (1.4-1.5) and this appears to favour the oxidation of these cations. When higher anode potentials are reached, however, oxygen evolution results. The following mechanism is suggested for the formation of cobaltic oxide at the anode.

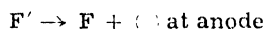

(heterogeneously on anode)

College of Science, Nagpur, A. N. KAPPANNA.

and

E. R. TALATY.

Central Salt Res. Inst.,

Bhavnagar, November 1, 1957.

1. Wernicke, *Pogg. Am.*, 1870, **141**, 120.
2. Skirrow, *Zeit. Anorg. Chem.*, 1902, **33**, 25.
3. Cohen and Glaser, *Ibid.*, 1903, **34**, 9.
4. Root, *J. Phys. Chem.*, 1905, **9**, 1.
5. Kappanna and Talaty, *J.I.C.S.*, 1951, **28**, 413.
6. Barbieri and Calzolari, *Zeit. Anorg. Chem.*, 1938, **170**, 109.

A COMPENSATED MOVING  
CYLINDER VISCOMETER

THE falling cylinder viscometer designed by Lawaczeck<sup>1</sup> and used by Bridgman,<sup>2</sup> Dow,<sup>3</sup> Awbery and Griffiths<sup>4</sup> in the determination of viscosities of liquids is based on the principle of a cylindrical metal bulb falling in the liquid coaxially in a vertical tube of only slightly greater diameter. The time of the fall  $t$  for a fixed distance  $s$  under uniform velocity is given by the relation

$$\eta = k \frac{t}{s} (\sigma - \rho) g \quad (1)$$

The determination of the viscosity  $\eta$  obviously involved the observation of the actual movement of the bulb in addition to the measurement of the densities  $\sigma$  and  $\rho$  of the bulb and liquid respectively.

We have effected a modification in the method and designed a viscometer in which the only

measurement to be made is the time taken by the cylinder to move a definite distance, the necessity of observing the movement of the cylinder itself not arising. The instrument consists of two exactly similar light solid cylinders or cylindrical bulbs A and B (Fig. 1)

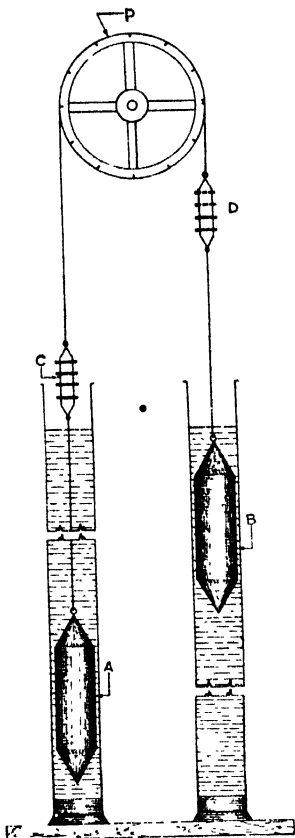

FIG. 1

moving in similar tubes of slightly larger diameter containing the liquid at the same temperature. The conical ends of each cylinder ensure its coaxial movement in the tube. The flexible nylon fibre—nylon fibre does not get wetted by ordinary liquids—connecting A and B passes over a light, almost frictionless pulley. C and D are light-weight carriers of identical shape and mass having holes into which riders of equal mass  $m$  may be inserted. The dimensions of the instrument are given in Table II.

When  $n$  riders are placed on one side, the connected system moves with uniform speed and it can be shown that the time taken ( $T$ ) to move a definite distance  $S$ , viz., that for one revolution of the pulley is given by

$$nmg - F - R \frac{\eta}{T} \quad (2)$$

where  $F$  is the slight friction of the pulley and  $R$  is an instrument constant.

This result may be used to compare the viscosities  $\eta_1$  and  $\eta_2$  of two liquids using the same number of riders and noting the times  $T_1$  and  $T_2$  respectively for a complete rotation of the pulley. Since the slight friction  $F$  remains practically constant, it follows from the equation (2) that

$$\frac{\eta_2}{\eta_1} = \frac{T_2}{T_1} \quad (3)$$

To test the usefulness and accuracy of the instrument, viscosities of mixtures of glycerine and water of different concentrations are compared with the viscosity of water. The results given in Table I show exact agreement with corresponding results obtained using an Ostwald's viscometer.

TABLE I

Mixture No.	Density of mixture $\rho_2$	Moving Cylinder Viscometer		Ostwald's Viscometer	
		$\frac{\eta_2}{\eta_1} = \frac{T_2}{T_1}$	$\frac{\eta_2}{\eta_1}$	$\frac{\rho_2 t_2}{\rho_1 t_1}$	$\frac{\rho_2 t_2}{\rho_1 t_1}$
I	1.0726	1.229	1.227	1.227	1.227
II	1.0734	1.403	1.403	1.403	1.403
III	1.0789	1.489	1.489	1.489	1.489

Compared with the falling cylinder viscometer, the special features of the new instrument are :

(1) the velocity of steady motion can be easily adjusted to any desired value by choosing the proper number of riders instead of altering the weight of the cylinders. The instrument can hence be used for liquids over a wide range of viscosities.

(2) the densities of the liquid and cylinder have not to be determined.

(3) the apparatus is useful for all kinds of liquids, transparent or opaque, as the actual movement of the cylinders has not to be observed. The rotation of the pulley gives the necessary information.

(4) the observations of time  $T$  may be repeated any number of times for the same number of riders while such repetition is difficult in the original falling cylinder form of the viscometer.

TABLE II

Solid cylinders of ebonite A and B	
overall length	.. 7.54 cm.
Length of cylindrical portion	.. 3.93 cm.
Diameter of cylindrical portion	.. 3.691 cm.
Inner diameter of tubes (brass)	.. 3.772 cm.
Circumference of pulley	.. 26.4 cm.

Complete theory and other details are being published elsewhere.

GOPALA MENON SREEKANTATH.  
C. A. VERGHESSE.

University College,  
Trivandrum,  
November 12, 1957.

1. Lawaczeck, *Zeitschrift des Vereins Deutscher Ingenieure*, 1919, **63**, 677.
2. Bridgman, *Proc. Amer. Acad.* 1926, **61**, 57.
3. Dow, *Physica* 1935, **6**, 71.
4. Awwery and Guthrie, *Proc. Phys. Soc.*, 1936, **48**, 372.

#### KOSTANECKI-ROBINSON PHENYLACETYLATION OF ORCACETOPHENONE AND ORCPROPIOPHENONE

HEILBRON, HEY AND LYTHGOE<sup>1</sup> have observed that resacetophenone upon Kostanecki-Robinson phenylacetylation gives exclusively a coumarin whereas respropiophenone under similar conditions gives mainly a coumarin with a small amount of chromone. It was therefore thought of interest to observe the behaviour of orcacetophenone and orcpropiophenone upon Kostanecki-Robinson phenylacetylation.

Orcacetophenone was phenylacetylated with fused sodium phenylacetate and phenylacetic anhydride when it furnished 7-phenylacetoxy-3-phenyl-4:5-dimethyl coumarin, m.p. 176-177° C. The latter on treatment with 80% sulphuric acid gave the corresponding 7-hydroxy-coumarin, m.p. 246-247° C. The constitution of this product was established by its hydrolysis to the corresponding cinnamic acid derivative and was further supported, by the synthesis of the corresponding chromone. The latter was prepared by the Claisen condensation of the orcacetophenone dimethyl ether with ethylphenylacetate, in presence of sodium, followed by the cyclization and demethylation.

Orcpropiophenone, on the other hand, on phenylacetylation under similar conditions affords 7-hydroxy-3:5-dimethyl-2-benzylchromone, m.p. 248-49° C., and the corresponding 7-phenylacetoxy derivative, m.p. 111-112° C. The latter could be easily converted into the former by means of 80% sulphuric acid. The

structure of the said hydroxy chromone was based on its synthesis through an unambiguous method. It was synthesized by the Claisen condensation of the orcacetophenone dimethyl ether with the ethyl phenylacetate followed by the methylation of the sodium salt of the  $\beta$ -diketone, cyclization and demethylation.

Organic Chemistry Labs., C. B. THANAWALLA.  
Institute of Science,  
Bombay-1; and  
Chemistry Department. P. L. TRIVEDI.  
M. N. College,  
Vianagar, N. G.,  
November 1957.

1. Heilbron, Hey and Lythgoe, *J.C.S.*, 1936, 295.

#### SEPARATION OF HÆMOGLOBIN COMPONENTS ON PAPER WITH THE AID OF A pH GRADIENT—A PRELIMINARY REPORT

For the diagnosis of abnormal hæmoglobins, electrophoretic mobility on paper in an alkaline buffer is sufficient in most cases to indicate the presence of a hæmoglobin variant, the distance travelled by the hæmoglobin depending upon the difference in the pH of the buffer and the iso-electric point of the hæmoglobin, the greater the difference the greater the movement of the hæmoglobin towards the anode.

It was considered theoretically possible to effect separation of the hæmoglobins by allowing their solutions to travel slowly across a filter-paper showing a pH gradient, so that the various forms of hæmoglobin will become relatively insoluble on the paper where suitable pH exists and thus separate in different places.

pH gradient was provided by soaking a circular filter-paper with M/100 citric acid and 'developing' the paper with M/75  $\text{Na}_2\text{HPO}_4$  from a central wick as devised by Giri *et al.*<sup>1</sup> for separation of amino-acids on a filter-paper circle. As more and more of the alkali flowed into the paper, some distance from the centre in a small width of paper, pH gradient was created as was shown by streaking universal indicator in a line from the centre outwards.

A circle 4 cm. in diameter was drawn at the centre of a Whatman No. 1 circular filter-paper of 13 cm. diameter. The paper was soaked in citric acid solution and blotted between sheets of blotting paper. The hæmoglobin solution was then spotted in a line along portions of the pencil mark with intervals in between the streaks to avoid mixing up of the different solutions. As many as six separate solutions

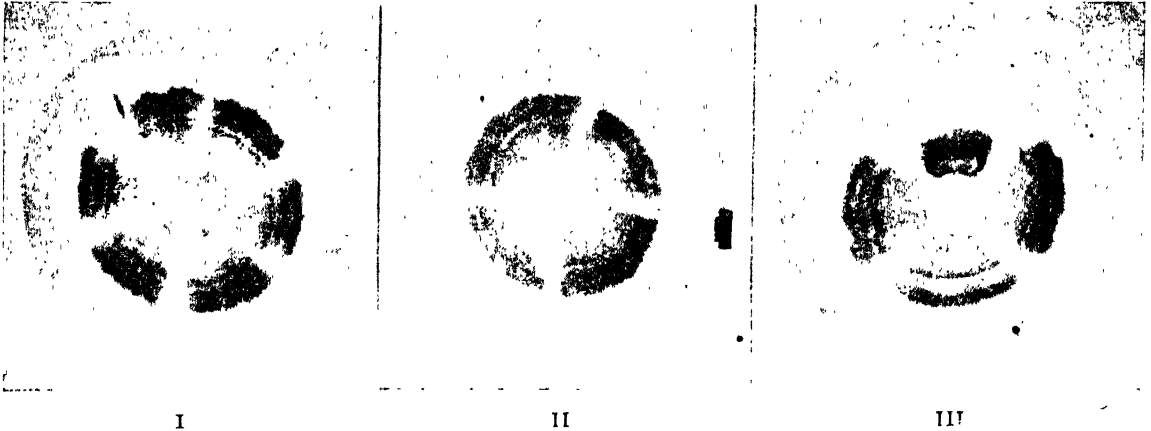

PLATE I. Six different samples of Oxy-Hb solution<sup>1</sup> showing separation into three components.

PLATE II. Hæmoglobins from Monkey (top right), Sheep (top left and bottom right), and Man (bottom left).

PLATE III. Met-Hb (top); Acid Hæmatia (bottom); Untreated Human Hb (right), and Citric Acid-Hb (left).

could be conveniently spotted on one paper. The  $\text{Na}_2\text{HPO}_4$  solution is then allowed to run in from the central wick. After 15-20 minutes, the paper was removed and stained according to the method of Owen<sup>2</sup> in light green solution, 200 milligrams in 100 ml. of 1% acetic acid for 10 minutes. It was then washed in 2-3 changes of fresh 1% acetic acid till the background was colourless and the protein solution showed up as green layers.

The result was unexpected. After 15-20 minutes, when the solution had travelled 5-6 cm. from the centre, it had separated into three distinct bands with a light trail of protein where the solution had travelled on the paper (Plate I). All the layers were present in the vicinity of the space showing the pH gradient. The optimum time was found to be about 15-20 minutes after which the layers tended to merge into one another, and the optimum concentration 4-5 g. of Hb%. Solutions prepared according to the method of Drabkin,<sup>3</sup> without the use of aluminium chloride or by the lead precipitation method of Tomkins<sup>4</sup> gave identical results. Oxy-Hb, CO-Hb, Foetal Hb and Hbs of monkey, chicken and sheep all gave more or less similar separation (Plate II). Met-Hb did not separate into layers. It moved either as a single band in a very erratic fashion in the form of radial streaks (Plate III). Solutions of acid hæmatin prepared by adding  $\text{N.HCl}$  to the Hb solutions showed two bands only (Plate III, bottom). Citric acid Hb showed a pattern similar to untreated Hb solution (Plate III, left).

Solutions of different pHs from 4-6.5 were used as soaking solutions keeping the  $\text{Na}_2\text{HPO}_4$

solution constant, and only indifferent separations were seen or mostly none at all. Using  $\text{Na}_2\text{HPO}_4$  for the soak and the citric acid for the run, no separation occurred, the protein moving as a single band. Similar result was obtained if the solutions were prepared in normal saline instead of distilled water.

The nature of the phenomenon is not clear. It appears that Hb as we obtain in solution is not a homogeneous substance, which as it is or as its denatured products, separates into three components under the conditions of the experiment. All the layers, however, showed normal absorption spectra for some minutes after the run. With time the spectra started fading and after about half-an-hour, no absorption bands could be seen. The chances are that separation of the Hb components occurs in their natural state and denaturation occurs sometime later.

Morrison and Cook<sup>5</sup> have reported separation on IRC-50 columns of normal adult Oxy-Hb into three components, showing normal absorption spectra. A similar inhomogeneity was noted by Boardman and Partridge<sup>6</sup> with the sheep and bovine CO-Hbs on the same resin. Morrison and Cook obtained two minor and one major component, whilst with the present method only one minor component is obtained and two others occur in relatively high proportions. At present, it is not possible to explain the difference in the findings. Work on the relative proportion of the components in normal and pathological Hbs is contemplated.

I am indebted to Prof. M. Balasubramanyan for interest and help in the work, to Dr. O. P.

Bagga who kindly drew my attention to some literature, and to the referee of *Current Science* for much valuable criticism.

Clinical Pathologist,  
Govt. Medical College,  
Patiala, September 9, 1957.

N. P. JAIN.

1. Giri, K. V., Krishnamurti, M. and Venkitasubramaniam, T. A., *Lancet*, 1952, **263**, 562.
2. Owen, J. A., *Analyst*, 1956, **81**, 26.
3. Drabkin, D. L., *J. Biol. Chem.*, 1946, **164**, 703.
4. Tompkins Victor, N., *Amer. J. Clin. Path.*, 1955, **25** (12), 1430.
5. Morrison, M. and Cook, J. L., *Science*, 1955, **122**, 920.
6. Boardman, N. R. and Partridge, S. M., *Biochem. J.*, 1955, **59**, 543.

### OXIDATIVE DECARBOXYLATION OF SOME ALPHA-HYDROXY ACIDS WITH SILVER IODIDE DIBENZOATE

THE use of silver iodide dibenzoate for the scission of alpha-glycols<sup>1</sup> and the conversion of primary aromatic amines to *s*-azo-compounds<sup>2</sup> has been reported. It has now been found that the complex oxidises alpha-hydroxy acids affording the corresponding aldehydes or ketones in very good yields, with loss of carbon dioxide. The reaction is thus analogous to the action of lead tetraacetate on alpha-hydroxy acids.

The procedure is briefly as follows: To the warm silver iodide dibenzoate complex freshly prepared from silver benzoate (2 moles) and iodine (1 mole) in dry benzene, the dry, powdered, alpha-hydroxy acid (1 mole) is added. Evolution of carbon dioxide starts immediately in most cases and becomes vigorous on warming the mixture. The mixture is then gently

Acid	Carbonyl compound	Yield %	M.P. of 2:4-Dinitrophenyl hydrazone
Mandelic acid	Benzaldehyde	72	236
<i>p</i> -Methoxy mandelic acid	Anisaldehyde	67	252-253
3,4-Methylenedioxy mandelic acid	Piperonal	76	263-264
Benzilic acid	Benzophenone	83	240
$\alpha$ -Hydroxy- $\beta$ -phenyl propionic acid	Phenylacetaldehyde	*	118-120

\* In this case much darkening and resinification occurred on heating the mixture. Only a poor yield of the hydrazone was obtained.

refluxed on the water-bath for an hour and a half. The warm solution is filtered, the filtrate washed with bicarbonate and water, dried and benzene removed on the water-bath. This yields the aldehyde or ketone. The following table gives a few experimental data.

It is interesting that whereas in the case of aromatic acids the reaction was facile, tartaric acid and citric acid failed to react.

Dept. of Organic Chem., P. S. RAMAN.  
University of Madras,  
Madras-25, November 11, 1957.

1. Raman, P. S., *Proc. Ind. Acad. Sci.*, 1956, **44**, 321
2. —, *Ibid*, 1957, **45**, 65.

### A NOTE ON PYROLYSIS AND IGNITION OF WOOD

THE ignition temperature of wood has been studied by many investigators (*vide* McNaughton, 1944). It is of interest not only for fire resistance studies but also in connection with spontaneous ignition in closed spaces (storage of fibre boards), etc. As with other combustible materials, the ignition temperature is not a constant but depends on the conditions of test. Wood begins to decompose at 275° C. with the evolution of combustible and non-combustible gases. Carbon monoxide, hydrogen and hydrocarbons have been identified in the former. Prinse (1915) showed that the "Ignition Point" is greatly influenced by the duration of exposure. In his experiments he noticed that at 180° C. ignition took place in 14.3 to 40 minutes. Recently, Jentsch and Jelitto (1953), using the Jentsch ignition tester with 14 wood samples varying in density from 0.15 to 1.0 g./cm.<sup>3</sup>, found this to vary from 240 to 310° C. Some years ago in connection with some work, we were interested in the ignition temperature and the combustible gases evolved on heating wood. The apparatus used is shown in Fig. 1. By showing a burning match stick to the issuing gas and noting the temperature of the electric furnace by means of a thermocouple the "Ignition Point" was found. The gases evolved were analysed in an Orsat apparatus. As further work is not contemplated at present, the results obtained are recorded in this note.

The ignition temperature for *Tetramales nudiflora* was found to be 228° C. The composition of the gases evolved can be seen from the results given in Table I.

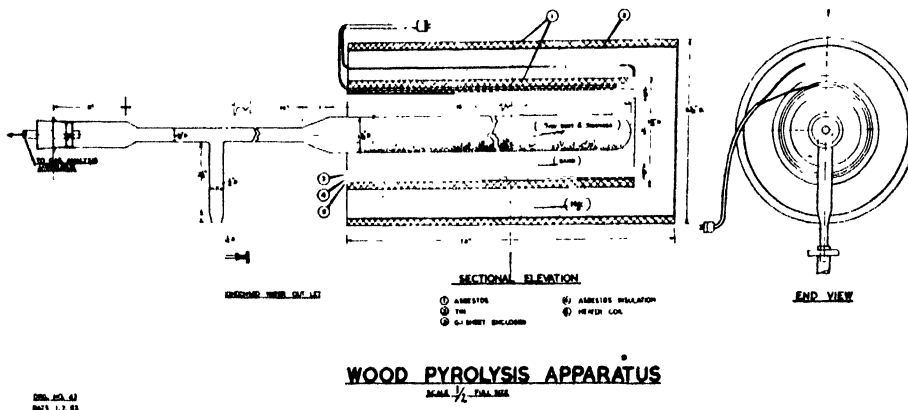

TABLE I  
Combustible gases from wood

Species	Moisture content %	Temp. at which combustible gases were observed to evolve	Temperature range during which gas was collected for analysis ° C.	Analysis				Ratio Re-idual O <sub>2</sub>	Analysis after correcting for air		CO CO <sub>2</sub>
				CO <sub>2</sub> %	O <sub>2</sub> %	CO %	Residual gases % 100 - (CO <sub>2</sub> + O <sub>2</sub> + CO)		CO <sub>2</sub> %	CO %	
<i>Tetrameles nudiflora</i>	8.70	288° C.	231-287	36.4	3.8	45.6	14.2	3.74	44.39	55.61	1.25
<i>Alstonia scholaris</i>	10.92	..	235-295	40.1	5.2	35.0	19.7	3.79	53.40	46.60	0.87
<i>Dichopsis elliptica</i>	6.57	..	242-295	41.4	6.1	29.7	22.8	3.74	58.23	41.77	0.72

Klar (1910) found 30.5% of CO and about 68% of CO<sub>2</sub> when wood is heated between 150 and 200° C. According to Coppick (1947), about 35% of CO is evolved during the Pyrolysis of cotton. According to Sander (1957), the decomposition CO/CO<sub>2</sub> ratio is close to 1 for most untreated lignocellulosic materials and decreases rapidly with fire-retardant treatment to about 0.75.

In our experiments the ratio varied from 1.25 with the *Tetrameles nudiflora* specimen to 0.72 with *Dichopsis elliptica* specimen. Narayanamurti and Gopalachari (1943) found *Tetrameles nudiflora* one of the easily inflammable woods.

Composite Wood Branch, D. NARAYANAMURTI.  
Forest Research Institute, JOSEPH GEORGE.  
Dehra Dun, October 29, 1957.

1. Coppick, S., "Flame Proofing Textiles," ACS Monograph, 1947.
2. Jentzsch, H. and Jelitte, K., Holz als Roh und Werkstoff, 1953.

3. Klar, M., Technologie der Holz verkohlung, 1910, Julius Springer, Berlin.
4. McNaughton, G. C., F.P.L. Madison No. R. 1464, 1944.
5. Narayanamurti, D. and Gopalachari, R., Ind. For. Bull., 1943, No. 118.
6. Prinse, R. E., Nat. Fir. Prod. Ass. Proce, 1915.
7. Sandor, B., FAO International Consultation on Insulation Board, Hard Board and Particle Board, 1957, paper 5, 23.

### PATTERNS OF REGENERATION IN NOTOTHYLAS INDICA KASHYAP\*

WHILE extensive researches on sporeling germination and regeneration have been carried on in the Acrogynous Jungermanniales and the position has been ably discussed by Fulford,<sup>1</sup> the Marchantiales and the Anthocerotales, particularly the latter, have apparently received relatively little attention in this connection in the past. Thus, although the sporeling germination has been studied to some extent in the Anthocerotales (Hofmeister,<sup>2</sup> Grönland,<sup>3</sup> Leitgeb,<sup>4</sup>

Campbell,<sup>5</sup> Pandé and Chopra<sup>6</sup>), the regeneration patterns do not appear to have been seriously noticed so far in this interesting group of Cryptogams and even the sporeling stages stand in need of elaborate study. The present investigation has, therefore, been undertaken at the suggestion of Dr. S. K. Pandé, in order to be able to present a detailed discussion of the sporeling and regenerant patterns in the Anthocerotales.

*Notothylas indica* Kashyap grows abundantly during the monsoons in Lucknow and its neighbourhood, the most favourite spot for its growth being the old historic Lucknow Residency Building. The local plants have been excellently worked out with respect to their morphological details by Pandé<sup>7</sup> and the sporeling patterns by Pandé and Chopra.<sup>6</sup> The present note gives an account of the regenerant patterns.

Full rosettes of plants along with soil, for this investigation, were collected from the Residency Building and brought to the laboratory. These were: (1) placed in covered Pyrex glass Petri dishes containing sterilized soil, from the home locality of the plant, with distilled-water, (2) treated with 0.02% NAA for 2 hours and placed as in (1), and (3) treated with 0.02% 2, 4-D for 2 hours and placed as in (1). Various stages of regeneration were obtained in about 2-4 weeks. Copious regeneration was observed in (2) whereas in (3) the plants were killed in about 3-4 days after culture, 2, 4-D possibly proving toxic in the concentration utilized for study. In (1), however, mostly ventral shoots developed.

The first indication of regeneration is that some of the thallus cells get dedifferentiated becoming papillate (Figs. 1, 2) and show relatively denser contents and prominent nuclei. Such dedifferentiated cells may occur on the dorsal and ventral surfaces of the thallus as well as along the margins. These divide transversely (Fig. 3), or obliquely (Fig. 4), to form two cells. Of the two cells thus formed, either the lower (Fig. 6), or the upper (Fig. 7), may divide first by a vertical wall. Subsequently, the other cell also divides in a similar manner (Fig. 12). In one case (Fig. 10), the lower of the two cells shows an oblique division.

Occasionally, there are some transverse divisions before any vertical walls are laid down (Figs. 8, 9, 12, 15, 17) forming a filamentous structure as described in the sporelings of *Anthoceros* by Leitgeb.<sup>4</sup> Ultimately an apical cell is responsible for the further growth

(Figs. 11, 13, 15) for some time in the early stages.

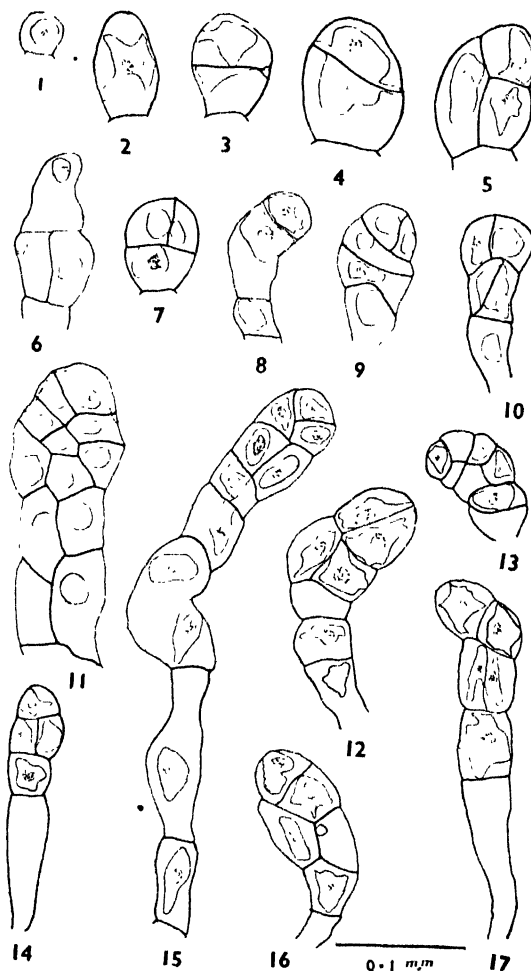

FIGS. 1-17. Fig. 1. A dedifferentiated cell. Fig. 2. An enlarged dedifferentiated cell. Figs. 3, 4. Two celled regenerants. Fig. 5. Early establishment of an apical cell. Figs. 6, 7. Initiation of vertical division. Figs. 8, 9, 12, 15. Stages showing few transverse divisions before vertical septation starts. Fig. 10. A four-celled regenerant showing an irregular division in the lower half. Fig. 11. An advanced stage. Fig. 13. An early stage with an apical cell. Figs. 14, 16, 17. Elongation of the dedifferentiated cell before septation commences. In Fig. 16 the long tube not shown.

Quite often, oblique divisions are laid down in such a way as to cut off an apical cell rather early in the development (Fig. 5) much in the same way as in the formation of the sporelings in *Notothylas indica* (Pandé and Chopra<sup>6</sup>).

In some cases (Figs. 14, 16, 17) there is a certain degree of elongation of the dedifferentiated cell before septations commence as in the elongation of the germ tube in the forma-

tion of the sporeling of *Anthoceros fusiformis* (Campbell<sup>2</sup>).

Such a wide range of variations in the developmental patterns of the regenerants in *N. indica* may merely be cultural variations of an unimportant nature or may be indicative of features of some phylogenetic significance. Further study with several members of the Anthocerotales is in progress and presentation of a complete picture is deferred till these results have been finalized.

Dept. of Botany, RAM UDAR.  
Lucknow University, V. B. SINGH.  
Lucknow, October 27, 1957.

\* Contribution from the Department of Botany, Lucknow University, New Series, No. 26.

1. Fulford, M., *Phytomorphology*, 1956, 6, 199.
2. Hofmeister, W., *The Higher Cryptogamia*, Ray Soc. Publication, London.
- \*\*3. Grönland, *Ann. des Sci. nat.*, ser. iv, 1854, t. 1, 5.
4. Leitzel, H., *Untersuchungen über die Lebermoose*, Die Anthoceroteen, Leipzig 1874, 5, 82.
5. Campbell, D. H., *Structure and Development of Mosses and Ferns*, New York, 1918.
6. Pandé, S. K. and Chopra, N., *Proc. Indian Sci. Cong.*, Calcutta, 1957, 3, 230.
7. Pandé, S. K., *J. Indian bot. Soc.*, 1932, 11, 169.

\*\* Not seen in original.

### NOTE ON DIELECTRIC BREAKDOWN STRENGTH OF WOOD AND MODIFIED WOOD

As is well known, wood is preferred for many applications on account of its favourable physical properties. If we consider electrical properties it has a high electrical resistance (Narayanamurti, D., 1941), and low dielectric constant. As an insulator for many uses the dielectric breakdown strength has also to be taken into account. During the war, porcelain insulators used in the wireless masts of motor vehicles under certain conditions were found to break. These were replaced at the suggestion of the Forest Research Institute (Narayanamurti, D., unpublished work) by ones made of *Cupressus torulosa* (cypress) or *Tectona grandis* (teak) treated either with cashew shell oil, linseed oil or phenolic resin. These were found to be satisfactory by the user (Fig. 1). In addition, treated wooden pieces are often used as distance pieces of stator windings in generators and in the construction of transformers where the use of wood affects considerable saving in oil. The breakdown strength plays an important role wherever wood or modified wood is used in electrical equipment. For example, compreg finds application as lifting rods or

guides in 66 Kv. circuit breakers, links, switch bases, insulation rings, contact supporting bars, packing blocks, clamps, slipping barriers, etc.

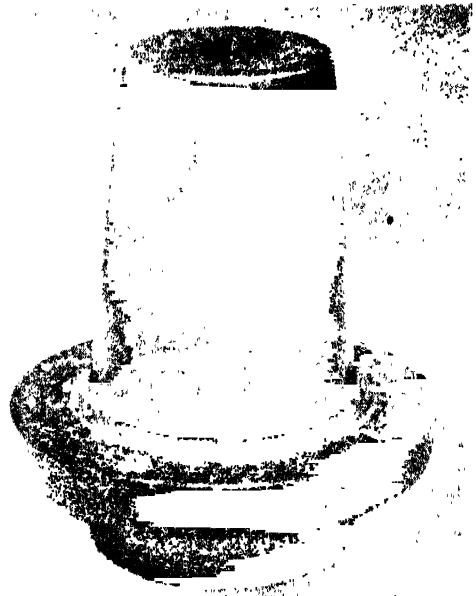

FIG. 1

According to Kollmann (1955), the breakdown strength of dry wood is about 27-28 Kv./5 mm., that of marble 10-20 Kv./5 mm. and of transformer oil, 20-25 Kv./5 mm. In view of its importance a few measurements on Indian timbers across the grain were made in this laboratory. An apparatus similar to the one recommended by A.S.T.M. was adopted (Fig. 2).

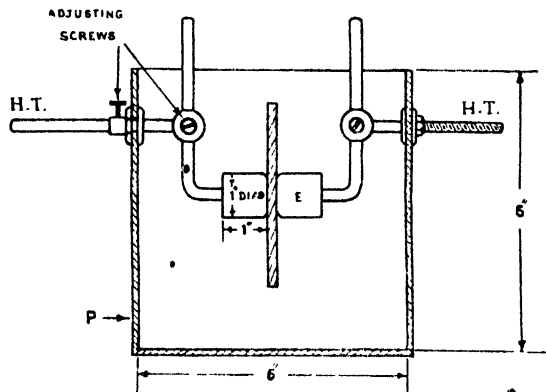

FIG. 2

With the transformer available voltages higher than 21 Kv. were not possible. All tests were done in air. The results of these preliminary



tests are given in Table I. The results are based on tests done on at least 2 samples. Results of other authors for other species are also included in the table for comparison.

Among the Indian timbers tested *Zanthoxylum rhetsa* haldu, and teak have a high value while mango, toon, chir, walnut, jaman have a low value. Treatment with creosote, paraffin,

TABLE I

Species	Thickness mm.	Breakdown voltage Kv.	Moisture content %	Remarks
<i>Acer</i> sp. (maple)	.. 250.0	80.0	6.0	Vieweg & Pfestorf
<i>Adina cordifolia</i> (haldu)	.. 6.3	> 20.5	7.0	
do.	.. 3.2	19.5	7.0	
<i>Beech plywood</i>	.. 6.0	12		Resin treated
do.	.. 6.0	42		
do.	.. 6.0	42		
	.. 12.0	13		
<i>Carpinus betulus</i> (hornbeam)	.. 250.0	80	5.0	Vieweg & Pfestorf
	6	6		
	12	8		Acc. to Burmeister dry control
	6	29		
	12	40		Resin treated
	6	34		
	12	50		Resin treated & lacquered
<i>Cedrela toona</i> (toon)	.. 6.3	12.0	9.4	
<i>Cullenia excelsa</i> (Kaim) A.R.T.	.. 6.3	15.5	0	
<i>Dalbergia latifolia</i> (rosewood)	.. 6.3	12.0	..	
<i>Dichopsis elliptica</i> (pali)	.. 6.3	> 20.0	6-7	
<i>Dysoxylum malabaricum</i> (white cedar)	.. 6.3	> 20.0	8.6	
do.	.. 3.2	20.0	8	
<i>Dipterocarpus</i> sp. (gurjan)	.. 3.3	15.5	Air dry	
do.	.. 6.3	15.5	do.	
<i>Eugenia</i> sp. (jaman)	.. 6.3	12.0	8.4	
<i>Fraxinus</i> sp. (ash)	.. 250.0	80.0	4.0	Vieweg & Pfestorf
<i>Holoptela integrifolia</i> (kanju)	.. 6.3	15.5	6.0	
<i>Mangifera indica</i> (mango)	.. 6.3	12.0	7.5	
do.	.. 6.3	> 20.5		Paraffin impregnated (1st 130° C. then 70° C. finally allowed to cool outside)
do.	.. 3.2	20.0		C.N.S.L. impregnated (heated at 120° C.)
do.	.. 6.3	> 20.0		
do.	.. 3.2	20.0		
do.	.. 6.3	> 20.5		Linseed oil impregnated (heated oil at 120° C.)
do.	.. 3.2	> 20.5		
do.	.. 6.3	> 20.5		P.F. resin treated. (50 p.s.i. & then cured)
do.	.. 3.2	> 20.5		
do.	.. 3.2	20.5		
do.	.. 6.3	18.5		Alkathene treated (in melted alkathene)
do.	.. 6.3	> 20.5		
do.	.. 3.2	16.5		Creosoted (50 p.s.i.)
do.	.. 6.3	21		
do.	.. 3.2	15.5		Shellac treated (50 p.s.i.)
<i>Fine, American</i>	.. 6.3	> 20.5	7.0	
	.. 3.2	20.5	6.5	
<i>Pinus longifolia</i> (chir)	.. 6.3	12.0	8.0	
do.	.. 6.3	15.5	0.0	
<i>Stereospermum chelonoides</i> (padri wood)	.. 6.3	19.0	8.0	
do.	.. 3.2	15.5	6.0	
<i>Tectona grandis</i> (teak)	.. 6.3	> 20.5	0	
do.	.. 3.2	> 20.5	0	
do.	.. 6.3	> 20.5	Air dry	
do.	.. 3.2	18.5	do.	
<i>Terminalia myriocarpa</i> (hollock)	.. 6.3	18	..	
<i>Zanthoxylum rhetsa</i> (kullillam)	.. 6.3	> 20	8.4	
do.	.. 3.2	> 20	3.7	

cashewnut shell oil and P.F. resin increases the breakdown strength.

Composite Wood Branch, B. N. PRASAD.  
Forest Research Institute,  
Dehra Dun, August 21, 1957.

1. Narayanamurti, D., *Ind. For. Bull.*, 1941, No. 150.
2. —, (unpublished work).
3. Kollmann, F., *Technologie des Holzes*, 1955, 1.

### WHAT CONSTITUTES A 'NETWORK' IN MAMMALIAN NEURONES?

RECENTLY the author<sup>1,2</sup> reported the complete absence of the classical 'Golgi apparatus' in the ageing spinal ganglion cells of the frog. A similar view is held by the author on the neurones of mammals. Besides, a study of the spinal ganglion cells of the immature rabbits (1 to 1½ months old) and adult squirrels provide an evidence of the existence of what has probably been interpreted as the 'Golgi reticulum'.

Phase-contrast microscopy of the freshly teased neurones of the rabbit and squirrel reveals the existence of refringent, homogeneous spheroids of varying sizes dispersed throughout the cytoplasm. However, in the squirrel a few spheroids show a duplex structure, with a refringent cortex and a pale medulla. A careful and intensive study of these neurones, especially from the rabbit ganglia, shows that the ground cytoplasm is not always homogeneous all through. Occasionally there are lighter-appearing, irregularly rounded or elongate, areas which interrupt the cytoplasm of higher contrast. The number and size of these spaces of lower contrast varies considerably in different



FIG. 1. Living spinal ganglion cell of immature rabbit showing prominent clear spaces and small homogeneous spheroids in the cytoplasm.  $\times 1,200$ .

nerve cells of the same size; and in some cases their number may be so large that the cytoplasm of higher contrast, which consequently becomes confined to narrow strips in between the lighter spaces, gives the look of a continuous apparent grey 'network' (Fig. 1). This so-called cytoplasmic net probably represents the 'reticulum' of Adamstone and Taylor<sup>3</sup> in the living spinal ganglion cells of the rat; and the refringent spheroids which are entirely located in this so-called net of cytoplasm have been misinterpreted by them as the mitochondria. A similar appearance of the cytoplasm has also been observed in neutral red-stained living neurones of squirrel in which the cytoplasm of higher contrast has been lightly stained (Fig. 2).

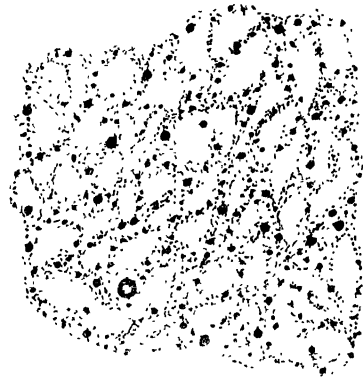

FIG. 2. Diagrammatic representation of the cytoplasm of the neurone of squirrel after staining in neutral red.

The network-like appearance of the cytoplasm is greatly accentuated by the action of fixatives, especially those which precede impregnation with silver nitrate and osmium tetroxide. A study of the finished preparations made by long impregnation techniques (Aoyama and Kolatchev) reveals that a black network, when formed, is produced by a non-specific deposition of silver or osmium on cytoplasmic 'network' of higher contrast, with intertwined lipid spheroids (sudanophil, osmiophil and argentophil). The network thus formed closely corresponds to the description of the 'apparato reticolare interno' of Camillo Golgi. The strings of precipitated osmium or silver with spheroids interposed on them often lie at the border, forming a sort of wall for the lighter-appearing spaces, which mostly become tubular in fixed preparations and appear as clear 'canaliculi'. The writer is not aware of the exact nature and significance of these spaces, but it seems definite that they do not conform to the definition of the classical 'Golgi apparatus'.

Moreover, there is no evidence of the existence of any argentophil material, distinct from the lipid spheroids, related to these 'canaliculi'. There is no doubt that indiscriminate use of silver nitrate and osmium tetroxide introduces serious artifacts, but if sparingly used, the essential form of the lipid spheroids is preserved just as in the living material.

Dept. of Zoology, S. K. MALHOTRA.  
Panjab University,  
Hoshiarpur, October 9, 1957.

1. Malhotra S K., *Curr. Sci.*, 1957, **26**, 157.
2. —, *La Cellule*, 1957, **58**, 363.
3. Adamstone, F. B. and Taylor, A. B., *J. Morph.* 1953, **92**, 513.

#### THE REACTION OF THE VACUOLE AND THE NUCLEUS OF LIVING YEAST TO NEUTRAL RED

THE nucleus is an extra-vacuolar structure in living vegetative cells<sup>1</sup> as well as spore zygotes<sup>2</sup> of *Saccharomyces carlsbergensis*. That these

two structures are unrelated to each other was shown in *S. cerevisiae* by stimulating the cells with visible nuclei by the addition of fresh medium.<sup>3</sup>

The least toxic among the vital stains is considered to be neutral red.<sup>4</sup> While the reaction of the vacuole to neutral red is rather specific,<sup>4</sup> the nuclei of higher organisms are rarely stained by it.<sup>5</sup> According to Guilliermond<sup>1</sup> (p. 136) when *S. ludwigi* is suspended in a dilute solution of neutral red, it precipitates and stains the vacuolar colloid which may then pass through the vacuolar boundary and get deposited in the peri-vacuolar cytoplasm. In later stages the stained granules dissolve and the vacuole is said to show an almost uniform staining.

Though Guilliermond repeatedly emphasized that the vacuole is not the nucleus of yeast,<sup>6</sup> the evidences adduced by him did not receive the attention they deserve because his experiments with neutral red were carried out on yeast cells in which the nucleus was invisible

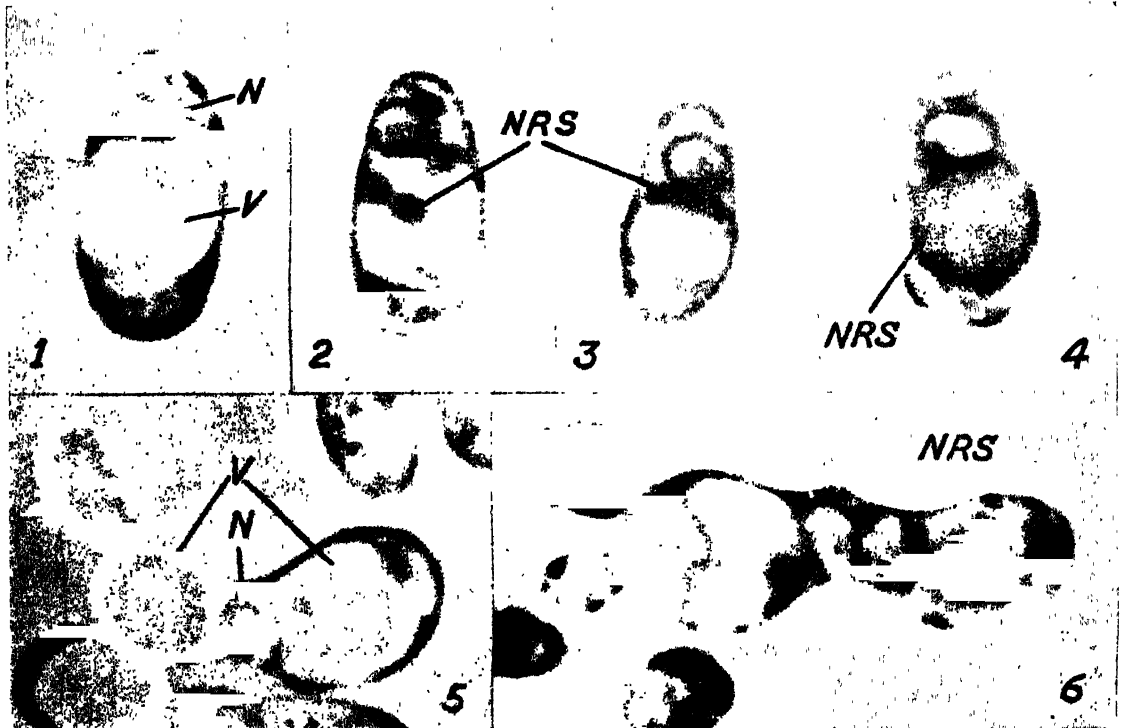

PHOTOGRAPH 1. Unstained living vegetative cell showing the extra vacuolar nucleus.  
PHOTOGRAPHS 2-4. The progressive staining of the vacuole after 15, 30 and 120 minutes of exposure to 0.01% neutral red.

PHOTOGRAPH 5. Unstained living zygote. The nucleus lies between the two vacuoles.

PHOTOGRAPH 6. A spore zygote after 120 minutes of exposure to 0.01% neutral red.

N, Nucleus; V, Vacuole; NRS Structures stained by neutral red. x ca 4,000.

in the living condition. The visibility of the nucleus in living vegetative cells and zygotes of *S. carlsbergensis* enabled a study of the reaction of the nucleus and the vacuole to neutral red.

The crop from cultures containing cells with visible nuclei<sup>1,2</sup> were collected, washed, and then suspended in a phosphate buffer of pH 7 for 15 min. They were then transferred to 0.01% solution of neutral red in distilled water and examined at intervals to follow the progress of staining. Photograph 1 is that of a living unstained cell showing the extra-vacuolar position of the nucleus. The nuclear membrane is clear and in this cell it has a crescent-shaped thickening in one region. When suspended in neutral red there is occasionally a non-specific tinting of the nucleus as well as the cytoplasm in cells which appear to be senescent.

In those with unstained cytoplasm and nuclei, granules coloured by neutral red appear inside the vacuole (Photograph 2) and exhibit brownian movement. They slowly increase in size, get attached to the vacuolar periphery and assume a semi-lunar shape (Photograph 3, NRS). Often they may be seen migrating into the cytoplasm. In later stages, the interior of the vacuole appears uniformly stained, the colour being deeper at the periphery of the vacuole (Photograph 4). Attention is invited to the fact that the accumulation of the dye at the periphery is not uniform.

Photograph 5 is that of a living unstained spore zygote. When the zygotes are suspended in neutral red, the two vacuoles exhibit differences in behaviour. In Photograph 6, one of the vacuoles appears uniformly stained, while the dye has collected at the periphery of the other vacuole in an irregular fashion.

The appearance of grains and crescents inside the vacuole (Photographs 2, 3, 4 and 6, NRS) on staining with neutral red necessitate their being considered as neo-formations, since these structures have no existence in the living unstained yeast (Photographs 1 and 5). During these changes in the vacuole, the nucleus exhibits no visible alteration and neither could any granules coloured by neutral red be seen inside the nucleus. Mounting the cells in neutral red, however, improves the contrast of the nucleus in micrographs.

The reaction of living yeast cells to neutral red reinforce the earlier work<sup>7,8</sup> that the vacuole and the nucleus are unrelated structures.

I am very grateful to Dr. M. K. Subramaniam for his guidance and encouragement.

Cytogenetics Laboratory, T. R. THYAGARAJAN.  
Dept. of Biochemistry,  
Indian Institute of Science,  
Bangalore-3, November 11, 1957.

1. Thyagarajan, T. R. and Subramaniam, M. K., *Naturwissenschaften*, 1957, **44**, 68.
2. —, *Proc. Ind. Acad. Sci.*, 1957, **45 B**, 187.
3. Royan, S., *Curr. Sci.*, 1956, **25**, 397.
4. Guilliermond, A., *The Cytoplasm of the Plant Cell*, Chronica Botanica Co., Waltham, Mass., 1941.
5. Gatenby, J. B. and Cowdry, E. V., *Holles Lee's Microtomist's Vade Mecum*, J and A. Churchill, London, 1929.
6. Guilliermond, A., *The Yeasts*, Trans. F. W. Tanner, John Wiley, New York, 1920
7. Subramaniam, M. K., *J. Ind. Inst. Sci.*, 1952, **34**, 11.
8. Royan, S., *Proc. Ind. Acad. Sci.*, 1956, **44 B**, 47.

#### ROOT INDUCING SUBSTANCE IN GROUNDNUT SEEDS

THE oil of the groundnut seed has been shown to possess growth-promoting (De Souza and Sreenivasaya, 1942) and mutagenic (Swaminathan and Natarajan, 1956) properties. The aqueous extract of seeds of a bunch variety of groundnut (TMV. 2) has been noted to break seed dormancy of spreading type of groundnut (Bhavanishanker Rao, 1956). Besides all these important properties another interesting observation is reported here.

Seeds of a spreading dormant variety (TMV. 3) of groundnut were soaked in aqueous extract prepared from seeds of a bunch variety (TMV. 2) and germinated in sand with a view



FIG. 1. Seedlings showing adventitious root formation.

to study the effect of the aqueous extract on breaking of dormancy. The seedlings that germinated showed an interesting phenomenon of adventitious root formation from the cotyledonary bases and stalks (Figs. 1 & 2). These roots were di- or triarch in trans-section. It is of interest to note that similar cases of root development from cotyledonary bases and stalks have been reported in seedlings of *Phaseolus vulgaris* L. (Malabotti, 1946) and Apricot (Bradley, 1957) due to treatments with heteroauxin ( $C_{20}H_{13}O_{11}N_2$ ) and 2, 4, 5-T and 2, 4, 5-TP respectively.



FIG. 2. Cotyledons showing root development from bases. (Cotyledons removed from the seedlings are shown separately.)

Adventitious root formation was noted only in treatments where the seeds were soaked in TMV, 2 groundnut seed extract and not in those where the seeds were soaked in water. Hence it is clear that the seed extract contains a root-inducing substance which shows properties like synthetic auxins.

The seeds of the bunch variety groundnut, TMV, 2, are highly non-dormant and they germinate in the field itself when rains are received at the time of harvest. Of the various varieties studied, only the bunch non-dormant variety exhibited the property of inducing adventitious root formation and hence its non-dormant nature may be due to the possible presence of a root-inducing substance in the seeds. Further studies are in progress with other bunch varieties and the results are being reported elsewhere.

The authors wish to record the help and guidance given by Professor T. R. Narayanan,

Systematic Botanist and Plant Physiologist, in preparing this note.

Oilseeds Section, S. S. NAGARAJAN,  
Agricultural College and S. GOPALAKRISHNAN,  
Research Institute,  
June 18, 1957.

1. De Souza, V. and Sreenivasaya, M., *Curr. Sci.*, 1942, **11**, 462.
2. Malabotti, A., *Nature*, 1946, **158**, 880.
3. Bhavani-banker Rao *et al.*, 1956, *Proc. 6th Scientific Workers Conference*, Coimbatore (under print).
4. Swaminathan, M. S. and Natarajan, A. T., *Curr. Sci.*, 1956, **25**, 382.
5. Bradley, M. V. and Crane, J. C., *Amer. Jour. Bot.*, 1957, **44**, 164

### BACTERIAL LEAF-SPOT OF *Pennisetum typhoides*

DURING 1956-57, a leaf-spot disease of *Pennisetum typhoides* Stapf. and Hubbard (The Pearl Millet, *Bajra* or *Cumbu*) was widely prevalent in the fields of the Agricultural Research Institute, Coimbatore. The disease was found both in the main and off-season crops. Symptoms first appear as water-soaked spots on the upper surface of the leaf, which turn reddish-brown in 2-3 days. With age, the spots enlarge, becoming rectangular in shape, 2-5 mm.  $\times$  1-3 mm. in size, bound by the vascular margin on the sides, and chocolate-brown in colour. No halo is found around the spots, but on maturity the spots are found to be markedly depressed from the surface of the leaf. Plants of all ages and all the leaves in the plant are commonly affected, but no other parts of the plant except the leaves seem to be infected. Transverse sections of the leaves through the spots clearly indicated the vascular nature of the disease, the causal bacterium being confined mainly to the bundles. The bacterium was readily isolated by the tissue culture and the dilution plate methods.

There seems to be no previous record of any bacterial disease on the host. One of the related species, *P. purpureum* Schum, however, has been reported to be, on artificial inoculation, infected by *Xanthomonas vasculorum* (Cobb) Dows., the causal organism of gumming disease of sugarcane<sup>1</sup> and *Bacterium albilineans* Ashby, the organism responsible for the leaf-scald of sugarcane.<sup>2</sup> The bacterium isolated from *P. typhoides* widely differs from the above two species in its morphological and physiological properties and in its pathogenicity and is, therefore, proposed to be assigned a new name, *Xanthomonas penniseti* Sp. nov.

*Xanthomonas penniseti* Sp. nov., Sowmini

Rajagopalan and Rangaswami: Short rods,  $0.7-1.1\mu \times 1.4-2.1\mu$  single or sometimes in chains of two or three, monotrichous with single flagellum, aerobic, gram-negative, capsulated, non-spore-forming, and non-acid fast. Forms yellowish brown colonies on nutrient agar, the colonies are circular, smooth and shining, with entire margin. Growth in nitrate broth dull-yellow with sedimentation in 2 days. No soluble pigment produced in the liquid or solid media. Gelatin liquefied in 2 weeks, starch hydrolysed, quick growth in litmus milk, casein hydrolysed, litmus not reduced, hydrogen sulphide not produced from peptone, ammonia and nitrite produced in 5 days, negative Indol and positive M.R. and V.P. tests. Acid and gas produced from glucose, maltose, sucrose, arabinose, levulose, starch, galactose, mannitol and salicin and no growth in xylose.

Causes leaf-spot on *Pennisetum typhoides* Schum, but on artificial inoculation failed to infect *P. purpureum*, *Sorghum vulgare* Pers., *Saccharum officinarum* L., *Setaria italica* Beauv., *Triticum vulgare* Vill., *Zea mays* L., *Oryza sativa* L., *Eleusine coracana* Gaertn., *Solanum melongena* L., *Datura metel* L., and *Lycopersicon esculentum* Mill.

C. K. SOWMINI RAJAGOPALAN.  
G. RANGASWAMI.

Mycology and Plant Pathology  
Section,

Agric. Res. Institute,  
Lawley Road, Coimbatore,  
October 15, 1957.

1. Orian, M. G., *Rep. Agr. Maurus*, 1942, 21, 285.
2. Hughes, C. G., *Commun. Bur. Sugar Exp. Stat. Queensland*, 1939, 35.

**THE COFFEE LEAF-MINER,  
AGROMYZA (MELANAGROMYZA)  
COFFEAEE HERING (DIPTERA:  
AGROMYZIDAE)**

OF the leaf-miners of coffee, those belonging to the order Lepidoptera are known to cause severe damage to coffee plants in Brazil, Kenya, East Dutch Indies<sup>1,2</sup> and some other countries. Among Diptera, *Oscinis coffeaee* Kon., and *Anthomyza coffeaee* N. are recorded as minor pests of coffee.<sup>1,3,4</sup> The Agromyzid, *Agromyza (Melanagromyza) coffeaee* has been reported to mine coffee leaves in Tanganyika (Hering<sup>5</sup>) and recently in Kenya (in a private communication from the Director, Commonwealth Institute of Entomology, London). A brief account of this leaf-miner, which

is now reported here for the first time in India on coffee, is given below.

The adult is a small black fly measuring about 2 mm. in length with its body covered with faint grey dust which produces a silky gloss. Head is slightly compressed antero-posteriorly, with prominent and slightly reddish eyes. The larva is cylindrical and pale yellow in colour measuring nearly 2 mm. when fully grown. It is highly specialised, the normal mouth parts being replaced by the pharyngeal skeleton serrated at the tip, well suited for mining in the leaf. The pupa is dark brown measuring about 2 mm. in length.

The eggs are deposited below the upper epidermis of tender and fresh coffee leaves, usually one in each leaf. The larva on hatching starts mining in the mesophyll layer under the upper epidermis. By feeding on the mesophyll they progressively make irregular, sinuous mines, shining in appearance (Plate I). Normally the

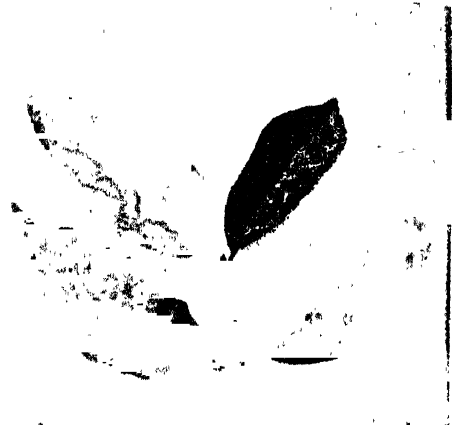

PLATE I

larvæ seem to feed for 7 or 8 days before pupation. Pupation takes place at the terminal end of the gallery, within the hardened larval skin, which forms a protective shroud. Adults emerge in 11 to 13 days under favourable conditions by breaking open the pupal chamber and the epidermal layer of the leaf.

At the Coffee Research Station, Balehonnur, this leaf-miner has been noticed to be very active during the months following the summer showers reaching maximum incidence by June-July. Thereafter, there appears to be a recession in the pest incidence as dry weather sets in, the pest practically disappearing by January-February. The pest appeared in a severe form in 1956 at the Research Station nursery on young *arabica* coffee plants. Otherwise, it is generally observed as a minor pest attacking

new flush on young and old plants. Attacked leaves are distorted and sometimes present wrinkled and fluted appearance.

Two Eulophid parasites, [Hymenoptera] (a) *Closterocerus* Sp., and (b) not determined, have been observed to parasitise this leaf-miner at the Station during the months of March and April and again in September and October. These parasites have been observed during the same period, the former occurring comparatively in larger numbers. Parasitization seems to be fairly high (about 80%) during the pre-monsoon period. It may be possible that these parasites have checked the multiplication of the insect to a large extent.

My grateful thanks are due to the Director, Commonwealth Institute of Entomology, London, for taking the trouble in identifying the insect and supplying the information on its previous records. I am also indebted to the Director and Entomologist, Coffee Research Station, Balehonnur, for their keen interest and guidance in the study.

Division of Entomology, C. K. VASUDEVAN.  
Coffee Research Station,  
Balehonnur, November 29, 1957.

1. Coste, R., *Les Cafeiers Et Les Cafes Dans Le Monde*, 1955 303-06.
2. Zimmerman, A., *Koffie*, 1928, 128-30.
3. *Indian Museum Notes*, 2 (6), 165.
4. Morstatt, K., *Die Schadlinge und Krankheiten des Koffiebaums in Ostafrika*, Beiheft No. 2, Zum Pflanzler, 1912 29-30.
5. Hering, E. B., *Melanogromyza coffea* sp. n., a leaf-miner of the coffee plant *Ann. Mag. Nat. Hist.*, London, 1940, 5 (11), 471-72.

#### EXPERIMENTAL INDUCTION OF LEAF HETEROMORPHISM IN *SESAMUM INDICUM* L.

CONSIDERABLE degree of leaf heteromorphism is known to occur in *Sesamum indicum* L. Sen and Pain<sup>1</sup> recorded that in normal plants of varieties I.P. 7 and I.P. 29, the lower leaves are ovate-lanceolate in shape while those in the apical region are linear-lanceolate with a large number of intermediate forms in between.

While investigating the effects of reduced carbohydrate supply, brought about by the removal of cotyledonary leaves and of shoot apices soon after germination, on the flowering of T. 10, certain interesting changes in the outline of the lamina and its margin are recorded. In the former case, the pair of leaves deve-

loped at the node just above the cotyledonary one, instead of being of the normal ovate type (Fig. 1), exhibit prominent concavities on both

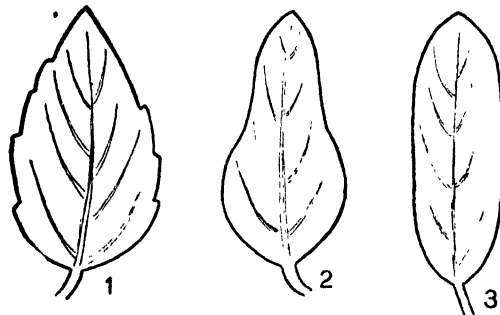

FIGS. 1-3

the sides which are nearer the apex than the base (Fig. 2). Subsequent leaves borne by the plant, however, do not show any abnormality. Changes in the shape of leaves referred to above cannot be induced by removing one of the cotyledons only.

Lowest leaves on branches developed at the axil of the cotyledons after decapitation are oblong (Fig. 3). Subsequent ones, however, gradually change to the normal type through a number of intermediate forms. Margin in both the new types of leaves are entire in contrast to serrate in the normal.

An uniformly similar response has been recorded in as many as 30 plants subjected to the removal of cotyledonary leaves and 15 to that of decapitation in the month of July 1957.

No change in the form of leaf in the following plants could be brought about by subjecting their seedlings (15-20 observations) to similar treatments:

- Phaseolus radiatus* L.
  - Vigna catjung* Endl.
  - Lens esculanta* Moench.
  - Cicer arietinum* Linn.
  - Lagenaria vulgaris* Ser.
  - Luffa aegyptiaca* Mill.
  - Cucumis sativus* L.
  - Cucumis melo* L. var. *Momordica*.
  - Ricinus communis* L.
  - Brassica campestris* L. and
  - Linum usitatissimum* Linn.
- Further studies are in progress.

Dept. of Botany, S. C. CHAKRAVARTI.  
Govt. Hamidia College, B. K. ARORA.  
Bhopal, November 29, 1957.

1. Sen, N. K. and Pain, S. K., *Proc. Nat. Inst. Sci.*, India, 1948, 14, 407.

## REVIEWS

**Quantum Chemistry—An Introduction.** By Walter Kuzmann. (Academic Press, Inc., New York), 1957. Pp. xii + 744. Price \$ 12.00.

The topics dealt with in this book are of interest to the physicist and chemist alike. Several books on quantum chemistry have appeared in recent years of which the best known perhaps is that by Lyring, Waiter and Kimball, but even this can be expected to appeal only to the theoretical chemist with a strong mathematical bias in view of its terse style. The volume under review in which "the necessary mathematics is presented in a more extended and more understandable form" will prove to be useful to a wider circle of chemists interested in understanding the important concepts that quantum mechanics has introduced into chemistry.

In the voluminous text of over seven hundred pages, the author has tried to carry out the ambitious plan of not merely expounding the application of quantum mechanics to molecular systems and the solid state, but also to provide the student with the necessary background of mathematics and the principles of quantum mechanics alongside with its applications in atomic physics. The author supplies the mathematical tools necessary to understand the subsequent chapters in Part I, while in Parts II and III, the principles of quantum mechanics and their application to atomic problems are developed. The contents of these two parts are the same as that to be found in the innumerable text-books available at present on quantum mechanics. Chapter 5, dealing with the principles of quantum mechanics reads more like a summary than an exposition of the subject, and it is doubtful whether the beginner, for whom the book is intended for, will be able to grasp the subject with this sketchy presentation without obscurity clouding his ideas. But, in a book of this sort wherein the author aims at covering a wide range of topics, such a condensation of some part or other becomes inevitable.

Part IV deals with the chemical binding of atoms into molecules which is a problem of fundamental importance to the physical chemist. Chapter 11 contains a sketch of the Heitler-London theory for the hydrogen molecule, the concept of hybridisation advanced by Pauling to explain the tetra-valency of carbon

and the molecular orbital treatment of the benzene molecule. The author begins the next chapter with the famous quotation of Dirac, *viz.*, "The underlying physical laws necessary for the mathematical theory of a large part of physics and the whole of chemistry are thus known" which is pleasing to every physicist, but he retorts soon with the challenge that the claim here is made "in principle" and not "in fact". Indeed, the application of wave mechanics to complex molecules is beset with insurmountable mathematical difficulties and the author rightly points out the necessity for renouncing even at the outset the attempts to obtain precise solutions of the Schroedinger equation. He emphasises the fact that ingenious chemical ideas can lead one to wave functions closer to the correct one. The chapter contains an interesting account of nuclear quadrupole moments in which it is shown how data on the nuclear quadrupole coupling constant enable one to obtain estimates of the charge distribution of the molecules and consequently get a clue regarding the nature of the electronic wave functions.

Part V, which is the last of the book, deals with systems in non-stationary states, *i.e.*, time-dependent processes. The topics dealt with in this part are very wide indeed, and to mention a few, include Lorentz's theory of electrons, the scattering of light by gases, liquids and solids, the diffraction of X-rays by crystals and the derivation of the Bragg Law, refraction of light, optical rotatory power and the colour of substances. In each case the author has tried to bring out the essential physical principles that he seeks to explain.

The printing and get-up of the book are of a high order. The book can warmly be recommended to all students of physics and chemistry interested in the application of quantum mechanics to atomic and molecular systems.

K. S. V.

**Solvents.** Seventh Edition. By Thomas H. Durrans. (Chapman & Hall), 1957. Pp. 244. Price 30 sh.

A solvent may be defined as a liquid substance capable of bringing a solid to a fluid state. This definition, although defective and inadequate, expresses the general idea underlying the use of solvents. In industrial chemical processes solvents play a very vital role



and these are almost wholly organic compounds having a wide range of physical properties and specificity of solvent power.

Though the use of solvents is by no means restricted to any single particular group of compounds, they have been closely interwoven with the development of plastics and with the addition of newer and newer kinds of plastics, a long list of them have been brought to use. Anyone dealing with solvents should be thoroughly acquainted with their characteristics and it is with this object in view, the book under review has been written.

The first part deals with some important properties of solvents and these appear under eight small chapters bearing the titles (I) Solvent action, (II) Solvent power, (III) Plasticising solvents, (IV) Solvent balance, (V) Viscosity, (VI) Vapour pressure, (VII) Inflammability, and (VIII) Toxicity. In Part Two of the book, no less than 200 compounds are dealt with under nine chapters. The compounds are classified under: (I) Hydrocarbons and sundry solvents, Nitro paraffins, (II) Alcohols and their ethers, (III) Ketones, (IV) Esters, (V) Glycols and their ethers, (VI) Cyclohexane derivatives, (VII) Chloro compounds, (VIII) Furanes, and (IX) Plasticising solvents. Under each compound its characteristics, specificity of solvent action toxicity, their uses and in many cases their method of preparation are given. Two appendices appearing at the end give the commercial names and probable composition, and a solubility table respectively. Many of the solvents listed in the book are employed in physical, chemical and medical laboratories for various purposes and a knowledge of their characteristics is therefore very desirable, especially their toxic properties, the harmful effects of which are underestimated and even overlooked. It is unnecessary to stress the usefulness of the book as its popularity is reflected in the number of editions that have appeared so far, since its first appearance in 1930; the present one being seventh revised edition. This monograph in applied chemistry is in the opinion of the reviewer a very useful reference book which ought to find a place in the shelves of chemists and even physicists.

**A Second Course of Electricity.** By A. E. E. McKenzie. (Cambridge University Press), 1956. Pp. viii + 357. Price 18 sh. net.

The appearance of the reprinted edition of this well-known text-book shows that the book is meeting a genuine need among students of electricity.

As the author has stated in the preface, the traditional treatment is adopted. The fundamentals are presented in a clear and elegant manner. The first three chapters deal with electrostatics. The next three chapters are devoted to the study of magnetism and electromagnetism. Most of the remaining chapters treat conventional topics in current electricity.

The title of the book should not be taken literally. The book contains two valuable chapters on modern physics. In the chapter on atomic physics, a large amount of useful information is given about radioactivity, the subject being brought up-to-date by the inclusion of some details connected with atomic fission. The chapter on electromagnetic waves gives some interesting facts which include a remarkably lucid account of radar and its applications.

The C.G.S. system of units is used but a reference is made to the advantages of the M.K.S. system. Though this system was officially accepted in 1935 by the International Electrotechnical Commission, physicists have not taken kindly to the alteration.

Attention has been drawn to the view (which follows from some assumptions in the M.K.S. system) that B and H in magnetic materials are physically identical. This, no doubt, simplifies dimensions and eliminates  $\mu_0$  (and similarly  $k_0$  in electrostatics) from many formulæ. There is also the other suggestion that  $\mu_0$  should be taken as  $4\pi \times 10^{-7}$  followed by some authors like Harnwell. It is however doubtful whether these treatments will be suitable for the level for which the book is intended.

The book contains a large number of worked examples. At the end of most of the chapters, a collection of useful problems is given, these having been selected with great care and properly graded. The diagrams are neat, clear and effective.

The format and binding greatly add to the attractiveness of the book. The volume is recommended as an excellent text-book for the B.Sc. standard. S. R. R.

**Vitamin A.** By Thomas Moore. (Elsevier Publishing Company, London W 8), 1957. Pp. xx + 645. Price 76 sh.

This book written by one who has been engaged in research on vitamin A and other aspects of nutrition for the past 30 years is the most comprehensive and compact source of information on vitamin A yet available. Though the vitamin proved to be a challenge to the organic chemist for more than a decade and a half, the conquest was over by 1947. Large

quantities of the synthetic vitamin are produced nowadays at competitive prices and the vitamin has now lost its thrill and excitement for the chemical investigator. But the interest in the vitamin on account of its biological properties continues. Thousands of papers have already been published on this topic but the tempo of research continues unabated, and not all workers are conversant with all the work. We find compiled in this book all the information available on vitamin A, its provitamins, particularly carotene, its derivatives and congeners. The fields covered include spectroscopy, chemistry, physiology, biochemistry, endocrinology, pathology, nutrition, medicine and animal husbandry.

The book is divided into eight parts, each part dealing with one particular aspect of the vitamin, such as chemistry, pathology, etc., and there are a total of 39 chapters. At the end of most of the chapters there is a summary which is usually in the form of running matter but occasionally in the form of tabular statement. Each chapter has its own bibliography given at its end. The final chapter entitled, "Assessment of our present knowledge of vitamin A" serves to remind us of the track still to be traversed on the biological side. Our knowledge of the biochemistry of the vitamin A is adequate only with regard to the very small amount of it present in the retina of the eye. This constitutes only about 0.1% of the total amount of the vitamin present in the human body and we have no idea yet of the biochemistry of the remaining 99.9%. Again, though it has been known for nearly 30 years that the animal system is capable of converting carotene into the vitamin, there is still no unanimity of opinion as to the mechanism of the change. These two examples are sufficient to show how difficult biochemical investigations can prove.

The book is written in an easy style. It has an Appendix containing much useful information and a comprehensive author index and subject index. The printing and get-up conform to the high standard which the *Elsévier Publishing Company* have established for themselves.

The only criticism which the reviewer can make is that the matter designated "Demonstration of the method by which the systematic name of vitamin A was derived" occupying the whole of page 99 is too elementary and out of tune with the general standard of the rest of the book.

The book will be an indispensable companion to all research workers in the field of vitamin A, and, besides, will be a valuable work of refer-

ence in all institutions offering courses in nutrition, dietetics, physiology, biochemistry, medicine and animal husbandry.

S. R.

**Methods of Enzymology, Vol. III.** Editors: S. P. Colwick and N. O. Kaplan. (*Academic Press, Inc.*) Pp. xxiv + 1054. Price \$ 26.

This volume, the third in the series, has maintained the same high standards for which its two predecessors were commended by the present reviewer. This treatise is devoted to the synthesis, isolation, qualitative detection, quantitative determination and properties of the numerous substrates and coenzymes corresponding to the enzyme systems described in the previous volumes. The book is divided into seven sections dealing with carbohydrates, lipids and steroids, citric acid cycle compounds, proteins and their derivatives, nucleic acids and their derivatives, coenzymes and related phosphate compounds, in all comprising of nearly 150 articles all of which are thorough and exhaustive in details. The articles under each section range from general procedures of isolation, etc., to highly specialised and recently developed techniques of preparation and assay of substrates. The last section on the determination of inorganic compounds should prove a useful addition. Even a cursory glance at the table of contents indicates the successful application of chromatographic procedures, column as well as paper for the isolation and assay of a wide array of metabolites. Some of the recently discovered metabolites such as carbamylphosphate and the various nucleoside di- and triphosphates involved in nucleic acid synthesis have promptly lined up with their elders in the volume. The treatment given to the specialised topics is both selective and comprehensive. The editors and the advisory board have indeed done a magnificent job in not only enlisting well over a 150 contributors with varied and specialised interests but also in giving this volume the smart and flawless form it has. The book is complete with two indices and an index to abbreviations of metabolites is a praiseworthy feature, since the modern biochemical terminology looks almost a jigsaw puzzle of all conceivable abbreviations. This volume will be of immense help on the bench to all biochemists, students and advanced workers alike, and the fourth volume in this major compendium will be eagerly awaited. In short, like its predecessors, Volume III is a must in any biochemical laboratory. It

should be added that it has all the accomplishments of an Academic Press volume, nice printing and get-up, absence of misprints, etc., and its high price is no exception to tradition.

K. V. GIRI.

**The Effects of the Sulfonyl Ureas and Related Compounds in Experimental and Clinical Diabetes.** Edited by R. Leyvine. (*Annals of the N.Y.A. Sciences*, Vol. 71, Art. 1, 2 East 63rd Street, New York-21), 1957. Pp. 1-292. Price \$ 4.00.

In the history of science it is not uncommon to find that fortuitous observations in a field have paved the way for outstanding discoveries in another field far removed from the original one. The discovery of sulfonylureas as anti-diabetic agents is a glaring instance of such chance observation and shows that the medical scientist of today has to be constantly alert about happenings in fields apparently unrelated to his own. The breath-taking pace at which medical science is progressing makes it a formidable task indeed, for the medical scientist to keep up such attitude of alertness. Nevertheless, the lesson of sulfonylureas shows that if maintained with assiduity such alertness could bring rich returns.

The sulfonylureas were originally brought to use as more soluble sulfa drugs with prolonged action but their effects in diabetes were consequences of Janbon's unexpected finding that one of them produced a disorder very similar to hypoglycæmia. Loubatierès immediately recognised their potentiality as anti-diabetic agents and his researches evoked considerable interest among workers in diabetes. As a result, considerable amount of information on these compounds accumulated within a relatively brief span of time.

Diabetes as a worldwide problem hardly needs any introduction. It is therefore in the fitness of things that the N.Y. Academy of Sciences convened the present Conference on Sulfonylureas. The number of the *Annals* containing the papers lists altogether 33 titles covering virtually every aspect of the action of these compounds. The list fittingly opens with a paper by Loubatierès which chronicles the history and development of research on sulfonylureas in relation to diabetes from 1942 to 1955. This is followed by papers describing the influence of endocrines on the action of these compounds; their metabolic effects on glucose, pyruvic acid, lactic acid and insulin; the role of insulinase in hypoglycæmic response induced by them; and their mechanism and

site of action in experimental animals and man. Last but not the least are the papers of a pure clinical nature, and those embodying observations on side effects and toxicities. The coverage of problems has been wide and all-embracing, but the reviewer feels that a grouping of the material under broad heads like metabolic, biological and clinical studies would have been more convenient for ready reference.

The major impressions gained after a perusal of the papers are that some of the sulfonylureas can and do control glycosauria and hyperglycæmia in the adult onset diabetic with a frequency of success varying from 60 to 80%. Unfortunately, the treated patient has to be subject to the same dietary control as is employed for insulin therapy. It has also been shown that any complication, such as an infection, may require the temporary use of insulin, and as such instruction in the administration of this hormone must never be neglected. It would, therefore, appear that to the practising physician and the patient, the sulfonylureas have no advantage over insulin. Nevertheless, these compounds have served the most important purpose of giving a fillip to research on many unsolved aspects of the diabetes problem. Indeed, their discovery might prove to be a landmark in diabetic research.

The N.Y. Academy of Sciences is to be congratulated for publishing this excellent number of the *Annals* on sulfonylureas.

N. N. DE.

**The Storage of Seeds for Maintenance of Viability.** By E. Biasutti Owen. (Commonwealth Agricultural Bureaux, Farnham Royal, England), 1956. Pp. v + 81. Price not given.

Genetic stocks, consisting of seeds of crop varieties and of related wild species and genera, are being built up at the agricultural experiment stations in India and abroad. There is, therefore, an urgent need of keeping these stocks of valuable seeds in a viable condition for a number of years. It is very encouraging to learn that this publication for the first time brings together in a systematic manner the relevant literature dealing with the storage of small quantities of seeds against loss of viability. Pertinent literature has also been compiled relating to the storage of large bulks of seeds.

Information is given on the longevity of seeds of field-, pasture- and horticultural-crops, and some wild plants, and the factors affecting

their viability. Certain subjects which have a bearing on seed storage have also been examined, such as: changes in respiration and chemical composition of seeds; conditions inducing growth of fungi; dormancy; hard-seed-ness; seed treatment and genetical factors. The chapter on genetical aspects of seed storage has been contributed by T. Ashton. The publication contains a useful appendix summarising information on viability of seeds after storage for different periods, under different conditions and gives the relevant reference.

N. L. DHAWAN.

'Venoms'. Edited by Elenor E. Buckley and Nandor Porges. (American Association for the Advancement of Science, Washington, D.C.), 1956. Pp. xii + 467. Price \$9.50.

This book is a collection of papers presented at the First International Conference on Venoms held at the Annual Meeting of the American Association for the Advancement of Science, from December 27 to 30, 1954, at Berkeley, California. The book has 61 papers, contains 113 illustrations and has a good index. Workers from all countries except the Communist countries excluding Yugoslavia have contributed papers. There are six papers from workers in India. The papers cover a wide range of subjects including pharmacology, biochemistry, use of venoms as a source of specific enzymes, production and standardization of antivenenes, treatment of bites of poisonous animals, etc. This is not surprising since an article by C. B. Pollard has for its title: "Venom Research: A Challenge to the Various Sciences". Altar Meister of the National Cancer Institute, Bethesda, has reported some very interesting work on the use of snake venom L-amino acid oxidase in the preparation in high yields of -keto-acids from the appropriate L or DL-amino acids, and also in the preparation of D-amino acid in high purity from a racemic mixture. Venoms are a rich source of many enzymes and it is possible that further work might reveal more uses of these enzymes as biochemical agents. There is also the possibility of their application in medical therapy.

In a paper by Swaroop and Grab, the annual mortality due to snake bites in the whole world excluding USSR, Central Europe and China, is estimated as 30 to 40 thousand. For India the annual death rate estimated from recorded snake bites is 5.4 per 100,000 population, which works out to about 20,000 per year. This high death rate should induce more workers in India to work on snakes, venoms and on protection against bites of venomous snakes.

The book covers a great deal of information which would otherwise require very laborious search in the literature of the different sciences. The book will be read with great interest by scientists in all fields and it is sure to stimulate in them further interest in this fascinating subject of poisonous animals and their poisons.

**Pharmacognosy of Ayurvedic (Kerala) Drugs.** Series 1, No. 3. (Published by the Central Research Institute, University of Travancore, Trivandrum), 1957. Pp. ii + 109. Price not given.

The previous number was reviewed by the undersigned in Vol. 23, No. 3 (March 1954) of this *Journal*. The present number deals with 20 medicinal plants from which 11 drugs are obtained. *Desmodium pulchellum* is given as one of the source plants for *Lodhra*. In most parts of the country species of *Symplocos* only (which are also given as source plants of *Lodhra*) are taken as the source of *Lodhra*. Probably in Kerala even *Desmodium pulchellum* Benth. is a source plant of *Lodhra*.

It is interesting to note that in the coastal Andhra Districts, the source plant of *Laksmana* is a species of *Solanum*, while in Kerala it is got from *Ipomæa sepiaria*, *Konig* and *Ipomæa obscura Ker-gaul*. It is said that "all authors are unanimous that *Laksmana* cures sterility in women. This claim is supported by the experience of many physicians though controlled clinical statistics are not available".

A more careful proof-reading would have avoided a printer's error like *Meria* for *Melia* in the contents.

The book is well got-up. The description and figures are well done. The chemical notes, promised in an earlier volume, are eagerly awaited.

The University of Travancore is to be congratulated on this pioneering venture, which will make *Ayurveda* better understood by the modern men of science.

K. S. RANGANATHAM.

#### Books Received

*Elementary Organic Chemistry.* By A. Saraswati. (S. Viswanathan, Acton Lodge, 11, McNicol Road, Madras-31.) Pp. ii + 336. Price Rs. 3.

*Cosmetics Science and Technology.* Edited by H. D. Goulden, Emil G. Klarmann, Donald H. Powers and Edward Sagarin. (Interscience Pub., New York.) Pp. xix + 1433. Price \$25.00.

---

---

## SCIENCE NOTES AND NEWS

---

---

### Temperature of 5 Million Deg.

Experiments at Harwell are widely believed to have provided the first evidence of the bringing about of fusion reaction under conditions of high temperature in a laboratory. Although this is no more than a first step towards the much more difficult achievement of bringing about the release of energy in this way on a useful scale, it is an important result scientifically. In the Harwell experiments the same reaction would have been brought about by pulsed heavy current electrical discharges, in a ring-shaped gas discharge tube filled with a mixture of heavy hydrogen and tritium at low pressure.

The temperature reached was believed to have been of the order of five million degrees Centigrade. In the conditions of the experiment, this should have been enough to bring about the fusion reaction on a sufficient scale to be detectable. The most sensitive means of detection is through the emission of neutrons as a product of the reaction.

During the passage of heavy current through the gas the discharge column is constricted into a narrow pencil which is unstable laterally. In order that high temperatures should be produced and contained, it is essential that the pencil, which contains the region of high temperature, should be prevented from contact with the tube walls.

This means that instability of the gas column must be controlled, it has been shown at Harwell that effective control can be secured—at least under moderate conditions of discharge—by an arrangement of magnets outside the tube.

This was an important advance, but it is recognised that the problem will in all probability become much more severe as the currents used are made bigger.

### South Pole Snow Pit

The International Geophysical Year Committee of the National Academy of Sciences has announced that a snow pit dug at the Amundsen-Scott IGY South Pole Station had reached a depth of 50 ft. on October 1. The pit, which has been dug by hand during the Antarctic winter, serves a dual purpose: the successive levels of snow laid bare provide an unspoiled record of climatic and other history, and the

snow itself is melted for the station's water-supply.

The temperature in the pit is nearly constant at  $-60^{\circ}\text{F.}$ , while at the surface a record temperature reading of  $-102.1^{\circ}\text{F.}$  was recorded on September 17. During the period May 11 to September 17, South Pole temperatures were lower than  $-95^{\circ}\text{F.}$  17 times.

A study of snow stratification, combined with examination of snow crystals and density, yields a history of the Antarctic. For example, traces of ash may indicate that a volcanic eruption took place hundreds of years ago, and pollen deposits provide a clue to past wind systems. Paul Siple is scientific leader at the Pole station, where there are eight other scientists and a similar number of Naval personnel.

### Cold Vaccine

On September 19, 1957, Winston H. Price, Associate Professor of Epidemiology and Biochemistry, and Director of the Division of Ecology at the Hopkins School of Hygiene and Public Health, announced the development of a vaccine for one strain of the common cold. The virus is the JH virus (for Johns Hopkins), which Price isolated 4 years ago and which, in a 2-year study, was found to cause 30% of the cold cases examined. The vaccine proved to be 80% effective in treating the JH virus, and the work has been confirmed by three other laboratories.

"The JH virus was found in association with an upper respiratory outbreak in children.

"Children given a vaccine prepared from inactive JH virus showed an attack rate about 8 times lower than that of the children receiving the placebo injections.

"No untoward reactions were observed in 401 individuals receiving the vaccine, which was prepared from inactivated JH virus grown in monkey kidney epithelial tissue.

"It is concluded that the JH virus is the cause of the cold-like illness in humans and that an inactivated vaccine can be prepared from the virus which protects against the overt illness due to the JH virus."

### Cardiac Studies

A radioisotope technique for the determination of cardiac output which is said to offer "virtually unlimited potential" in the diagno-

sis and control of heart disease is described in a report of United States' Air Force Aero-medical Research. The non-traumatic method uses injection doses of radio-iodinated human serum albumin. The technique is simple and highly accurate and can be used to demonstrate precisely the variations of certain cardiac output under stress and response to medications.

#### Soil Moisture Content

The development of a neutron meter by scientists of the Western Province Fruit Research Station has made it possible to determine the moisture content of soil in, literally, a minute. The standard oven-drying method takes 16 hours and, moreover, requires the transportation of the soil sample to a laboratory. The new instrument can be operated easily in the field by one person, and so many measurements can be made that errors due to the use of samples are reduced.

The radioactive source consists of 10 milligrams of radium mixed with beryllium powder.

#### Electrodeposition and Metal Finishing

The India Section of the Electrochemical Society held a Symposium on 'Electrodeposition and Metal Finishing' at the Central Electrochemical Research Institute, Karaikudi, on December 27 and 28, 1957. There were 35 papers covering the theoretical and industrial aspects of electroplating, electrorefining, electrowinning, metal powders, anode phenomena, electropolishing, anodizing and protective coatings. The Section proposes to publish a Special Number covering the Proceedings of the Symposium.

#### Zoological Nomenclature

The International Trust for Zoological Nomenclature has announced that arrangements have been made for the immediate publication in book form of the first instalment of each of the *Official Lists* of valid zoological names and of the corresponding *Official Indexes* of rejected and invalid names, together with

the first instalments of the *Official Lists* of works approved as available for Zoological Nomenclature and of the *Official Indexes* of rejected and invalid works. The categories of names covered by these *Lists* and *Indexes* range from specific to ordinal names. The total number of entries contained in these instalments now to be published amounts to be about 5,000.

These *Lists* and *Indexes* have been prepared as a result of the decisions taken by the various International Congresses of Zoology held from time to time, starting from the Ninth Congress (Monaco, 1930) to the Fourteenth Congress (Copenhagen, 1953).

These *Official Lists* and *Official Indexes* constitute an important instrument devised to promote stability in Zoological Nomenclature and will thus be indispensable to all specialists engaged in taxonomic work in zoology and palaeontology.

Enquiries in regard to above publications should be addressed to the International Trust for Zoological Nomenclature at its Publication Office at 41, Queen's Gate, London, S.W. 7 (England).

#### Lady Tata Scientific Research Scholarships, 1958-59

The Trustees of the Lady Tata Memorial Trust are offering six scholarships of Rs. 250 each per month for the year 1958-59 commencing from 1st July 1958. Applicants must be of Indian nationality and *Graduates in Medicine or Science* of a recognised University. The scholarships are tenable in India only and the holders must undertake to work whole-time under the direction of a scientist of standing in a recognised research institute or laboratory on a subject of scientific investigation that must have a bearing either directly or indirectly on the alleviation of human suffering from disease. Applications must conform to the instructions drawn up by the Trust and should reach by March 15, 1958. Candidates can obtain these instructions and other information they desire from the Secretary, the Lady Tata Memorial Trust, Bombay House, Bruce Street, Fort, Bombay-1.

2-58. Printed at The Bangalore Press, Bangalore City, by C. Vasudeva Rao, Superintendent, and Published by A. V. Telang, M.A., for the Current Science Association, Bangalore.

All material intended for publication and books for review should be addressed to the Editor, *Current Science*, Raman Research Institute, Bangalore-6.

Business correspondence, remittances, subscriptions, advertisements, exchange journals, etc., should be addressed to the Manager, Current Science Association, Raman Research Institute, Bangalore-6.

#### ANNUAL SUBSCRIPTION

India: Rs. 8-00. Foreign: £ 0-16-0. \$ 2.50.

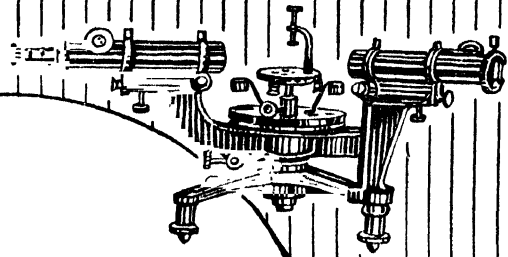
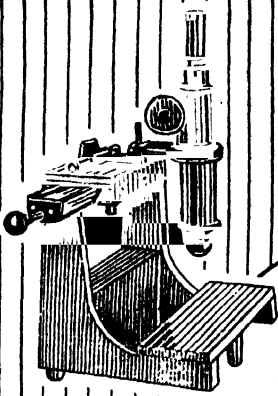

# KAYCEE

## SCIENTIFIC INSTRUMENTS

*for  
Accuracy*

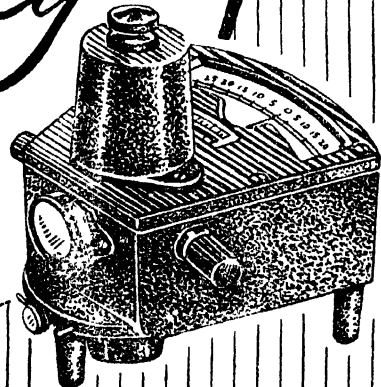
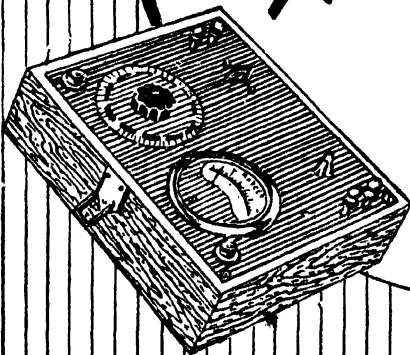

### RADIO LAMP WORKS LTD.

*Head Office:*

Mahatma Gandhi Road, Bombay

*Sales Offices at:*

BOMBAY, CALCUTTA, DELHI, KANPUR, MADRAS, INDORE.

## MICROWAVE ABSORPTION IN SOLIDS

### INTRODUCTION

FOLLOWING the phenomenal development in the field of microwave techniques during the war, several new avenues of investigation sprung forth utilising these techniques. The branch of knowledge under the title, Spectroscopy at Microwave Frequencies, which employs electromagnetic radiations of wavelength lying in the region of 30 cm. down to a fraction of a millimetre, is today a highly developed tool, and has led to a deeper understanding of certain physical properties of matter. This includes absorption spectroscopy, the absorptions arising as the result of quantised rotational and other transitions of molecules in the gaseous state, as also the absorption of microwaves by solid state compounds, caused by the presence of unpaired electrons, under suitable conditions. The transition energies involved in these are of a ten-thousandth of an electron volt, and are produced as a result of weaker forces of a molecular or solid state character, which bind the different atoms together to form molecules or a crystalline lattice. In this article the use of centimetre waves for the investigation of the solid state will be set forth.

A considerable amount of research has been carried out on microwave absorption in solid state compounds, in recent years. The application of this technique is rapidly expanding and covers electron magnetic resonance, cyclotron resonance and a number of non-resonant phenomena. The electron magnetic resonance techniques have been applied to defect solid state including impurity sites in solids, conduction electrons in metals, ferromagnetic, ferrimagnetic and antiferromagnetic materials. Cyclotron resonance has been studied in connection with semiconductor materials, while the non-resonant absorption of microwaves has been observed in conductors at low temperatures and in ferrites.

### ELECTRON MAGNETIC RESONANCE

The energy levels of a system possessing a resultant spin angular momentum can be split by the application of a magnetic field  $H$ . The distribution of such a system among the possible energy states will be in accordance with the Maxwell-Boltzmann distribution law. The separation of the energy states is often a linear function of  $H$  for the magnetic fields used in microwave spectroscopy, and transitions may be induced between them by a quantum of radiation ( $h\nu$ ) where  $h\nu = g\beta H$ . In this relation  $g$

is a numerical parameter called the spectroscopic splitting factor,  $\beta$  is the Bohr Magneton. It is usually necessary for the radiation employed, to have a component of high frequency magnetic field, perpendicular to the applied field  $H$ . When the assembly is in thermal equilibrium the induced transitions give rise to a net power absorption and in many cases this occurs at a field and frequency related by  $g \sim 2$ . In the case of ideally free electron spin, the value for  $g_s = 2.0023$ .

Elements of the transition and rare earth groups are paramagnetic by virtue of the presence of unpaired electron in their shell structure, possessing thereby an angular momentum which gives rise to permanent magnetic moment associated with these. Compounds containing these ions can therefore under suitable conditions exhibit paramagnetic resonance. Besides these compounds, any imperfection in a crystal which has one or more unpaired electrons associated with it can in principle give rise to paramagnetic resonance absorptions. Types of defects which have been investigated by the resonance technique include, (1) donors and acceptors in semiconductors, (2) colour centres in alkali halides, (3) defects produced by irradiation, (4) transition group ion impurities, and (5) free radicals.

For studying paramagnetic resonance, a small crystal (of about 1 to 2 mm. in size) is placed at the end of a cavity resonator tuned to the appropriate wavelength which is usually about  $1\frac{1}{4}$  cm. or 3 cm. In this position the crystal is in the greatest oscillatory magnetic field, a condition necessary for the magnetic dipolar transition to be observed. The resonator is placed in the field of an electromagnet, and the polarisation of the R.F. magnetic field is so arranged that the two magnetic fields are at right angles to each other. Conventional methods are used to feed the microwave power from the reflex klystron into the resonator and from the resonator to the detector, ordinarily a silicon-tungsten crystal rectifier. To detect resonance, the frequency of the oscillator is kept constant and the magnetic field is varied. When absorption occurs the detector output decreases. This can be observed either with a sensitive galvanometer or by modulating the static magnetic field with a small fluctuating magnetic field and measuring the A.C. output from the crystal, after suitable amplification. It is usual to cool the crystal under investigation to temperatures of liquid air, hydrogen,



or even helium in order to reduce the lattice vibrations which are sometimes so large that they cause line broadening. Further, since the absorption intensity is inversely proportional to the temperature, cooling helps in intensifying the absorption lines.

The paramagnetic ions, or the above-mentioned defects present in a crystal are greatly influenced by their environment. The energy levels undergo Stark splitting due to the presence of internal crystalline fields. The shift of the spectroscopic splitting factor from the free spin value, usually indicates the strength of the spin orbit interaction effects of the unpaired electron. The symmetry of this field quite often departs from isotropy and the immediate consequence of this is, that the  $g$ -value depends on the direction in the crystal to which the lines of force of the static magnetic field is parallel. A study of this therefore provides information regarding the symmetry of the surrounding ion, and about the nature of the binding between the ion and its immediate diamagnetic neighbours. The width of the absorption lines in a resolved spectrum depends on factors, (a) the rate at which the microwave energy absorbed by the electron spins is transferred into thermal (lattice vibration) energy, i.e., on the spin-lattice relaxation time, (b) the magnetic dipole interaction between neighbouring paramagnetic systems, (c) the exchange interaction between neighbours. A study of the line width may give information about these factors.

Although the resonance spectrum arises from electronic transitions, any nucleus of spin  $I$  associated with the defect is labelled by  $(2I+1)$  fold hyperfine splittings in the spectrum; the magnitude of the splitting indicates the time spent by the unpaired electron near this nucleus. This is a most useful aspect, and recently it has been shown that the resolving power for hyperfine structure can be enormously increased by the application of double resonance techniques. In this method by using sufficient microwave power, the electron magnetic resonance line of a material with a fairly long relaxation time is saturated, so that its intensity is practically reduced to zero. If now, a nuclear resonance frequency which corresponds to the hyperfine splitting of the energy levels is supplied, the upper level is depopulated by the stimulated emission of this frequency, which results in restoring the electron magnetic resonance line. This double resonance method has a wide application which can be used for measuring nuclear magnetic moments, or for accurate measurement of the spacing of

the energy levels, or in some cases for resolving hyperfine structure.

#### SOME EXPERIMENTAL RESULTS

##### SEMICONDUCTORS

Electron spin resonance has been observed for the interstitial donors Li in Si and for substitutional group V donors P, As and Sb in Si. The experiments have been made at low temperature ( $4^\circ$  K) where the semiconductor is effectively an insulator. These impurities have one extra loosely-bound unpaired electron compared with the atoms of the host material and this electron is responsible for the resonance spectrum. The experimental spin resonance results give direct evidence for electrons moving in large s-like orbits and include the following features: (i) The spin-orbit interaction effects are small; the  $g$ -shifts are small and, as expected, negative for donors, and the spin lattice relaxation time being very long; (ii) There is appreciable overlap, and therefore there is an exchange interaction between electrons belonging to donors separated by many lattice spaces; (iii) In isolated donors, the hyperfine interaction of the unpaired electron with the nucleus is of the order of 1/100 or less of the free atom value, corresponding roughly to the electron being spread over a hundred or more atoms, and (iv) in dilute samples, a limit to the line width is set by the small unresolved hyperfine structure.

##### DEFECT SOLIDS

Bombardment of crystals with high energy radiations like X-rays,  $\gamma$ -rays, neutrons and other accelerated particles result in imperfections and dislocations, and this is known as radiation damage. The technique of paramagnetic resonance is immensely helpful in this field, as most forms of damage have trapped electrons, or holes associated with them and hence will exhibit resonance absorption. Colour centres in alkali halides are produced by irradiating the halides with X-rays or  $\gamma$ -rays. Electron spin resonance has so far been observed for F-centres,  $V_3$ -centres and photo-dissociated U-centres, in alkali halides. An F-centre is a negative ion vacancy with a trapped electron. A  $V_3$ -centre consists of two adjacent positive ion vacancies with an electron hole. A U-centre is a negative ion vacancy containing a negative hydrogen ion  $H^-$ . A study of resonance absorptions has shown that the  $g$ -shift is negative or positive, as expected for electrons or holes respectively. Illuminating results have been obtained regarding the nature of these centres from a study of the line width,

line shape and hyperfine contribution measurements.

Following these measurements on irradiated alkali halide crystals, electron magnetic resonance has been observed in several other irradiated crystalline structures, including plastics. Of the irradiated crystalline structures studied, particular mention may be made of ice, frozen heavy water, quartz, nitrate salts and frozen sulphuric acid. The results obtained with ice and frozen  $D_2O$  suggest that electrons have been trapped near H or D atoms and are interacting with their nuclei to give a hyperfine structure.

X-irradiation in quartz produces magnetic centres and a smoky coloration which can be removed by heating. The spin resonance results show that each centre has one unpaired hole, with  $g_{\perp} = 2.00$  and  $g_{\parallel} = 2.06$ , and axis of symmetry parallel to an Si-Si direction. There is a small six line hyperfine structure attributed to  $Al^{27}$ . This structure shows some anisotropy and the axis of symmetry is approximately along an Si-O direction, which is different from the  $g$ -value axis. It is supposed from this result that the unpaired spin is located on O rather than on Al. The results illustrate a general rule which helps in recognizing the structure of defects, namely, that if the  $g$ -value axis of symmetry is different from the hyperfine structure axis, it can usually be assumed that the unpaired electron is not centred about the nucleus responsible for the hyperfine structure.

Neutron irradiated diamond is another very interesting case. The resonance spectrum contains a strong central line at  $g = 2.0028$  and a number of weaker satellites which can be ascribed to magnetic centres with electronic spin  $S = 1$ . The satellite lines are not reduced in intensity by heat treatment, as does the central line and they are therefore attributed to some stable defect such as a  $C_2$  molecule.

The spectra of irradiated frozen sulphuric acid by  $\gamma$ -rays show intense paramagnetic absorption lines attributable to the presence of atomic hydrogen, and other satellites spaced at the equivalent proton resonance frequency, away from the line.

#### CONDUCTORS

The conduction electrons in metals are really a third type of free electron for which paramagnetic resonance can be observed. The main difference between spin resonance from conduction electrons and that from paramagnetic ions in non-conducting materials, are, (i) the signal intensity is small and approximately

independent of temperature, (ii) if the sample dimensions are larger than skin depth, the amplitude and phase of the microwave radiation is different for magnetic carriers at different distances from the surface, and (iii) the magnetic carriers are moving and diffusing in and out of the skin depth which modifies the shape of the observed absorption lines. Measurements have been made with solutions of alkali metals in ammonia. The  $g$ -values measured were  $g = 2.0012 \pm 0.0002$ . Following this, resonance has also been observed in several other metals including Li and Be and in dilute alloys of Mn in Cu, Ag or Mg, graphite, and some superconducting metals.

#### FERROMAGNETIC, ANTIFERROMAGNETIC AND FERRIMAGNETIC MATERIALS

Ferromagnetic materials are characterised by the property of spontaneous magnetisation under the influence of a magnetising field. The theory of ferromagnetism is based up on coupling of the neighbouring ions, by strong exchange interactions. The investigation of microwave resonance absorption in ferromagnetic materials has provided us with information regarding exchange forces and anisotropy constants. The expression for the resonance for the microwave field in the plane of a plane sample is

$$\hbar\omega_r = g\beta\sqrt{\{H^0 + \phi_1\} \{H^0 + 4\pi M^0 + \phi_2\}}$$

where  $\phi_1$  and  $\phi_2$  are correction terms to allow for the effect of anisotropy, and the rest of the symbols have the same significance as noted earlier. The experimental set-up for observing ferromagnetic resonance is the same as that described for paramagnetic resonance. However, in one method the specimen is a thin plane surface of the ferromagnetic material while, in another method the power absorbed in dilute suspension of colloidal ferromagnetic particles which are assumed to be spherical, is measured. Iron, cobalt, nickel and a number of ferromagnetic alloys have been studied. There are those still unexplained facts that high values for  $g$  is observed, and the line width is larger than that given by exchange interactions.

#### ANTIFERROMAGNETIC MATERIALS

In the simplest case, an antiferromagnetic material consists of two sublattices of paramagnetic ions which at low temperatures are magnetised in opposite directions by exchange interactions. When the material is progressively cooled, at a temperature  $T_N$ , the material enters the antiferromagnetic region. The frequency condition for an antiferromagnetic material is given by

$$\omega = g \frac{e}{2mc} [H_0 \pm (H_A (2H_E + H_A))^{\frac{1}{2}}]$$

where  $H_0$  is the applied magnetic field,  $H_E$  is the Weiss exchange field and  $H_A$  is the anisotropy field. It follows from the above equation that it should be possible to obtain antiferromagnetic resonance in zero external field for some substances, as in the case of ferromagnetic resonance. This is because, splitting of the levels occur in the Weiss exchange field  $H_E$ . In some cases at low temperatures this field has a high value, and with a  $g$ -value close to 2, resonance can occur only at short wavelengths, outside the limits. Successful antiferromagnetic resonance experiments are few. In the case of  $\text{Cr}_2\text{O}_3$  powder,  $\text{MnF}_2$ ,  $\text{CuMn}$  and  $\text{AgMn}$  alloys,  $\text{CuCl}_2 \cdot 2\text{H}_2\text{O}$ , and  $\text{CuBr}_2 \cdot 2\text{H}_2\text{O}$ , resonance has been observed.

#### FERRIMAGNETIC MATERIALS

The ferrites belong to the group of compounds having the general formula  $\text{MO.Fe}_2\text{O}_3$ , where  $M$  is a divalent metal ion such as  $\text{Mn}$ ,  $\text{Co}$ ,  $\text{Ni}$ ,  $\text{Cu}$ ,  $\text{Zn}$ ,  $\text{Cd}$ ,  $\text{Mg}$ ,  $\text{Fe}$ . They have the spinel structure and are distinguished as two different classes, 'normal' and 'inverted', according as the divalent metal ion has tetrahedral or octahedral groups of surrounding oxygen atoms. These materials have important practical applications at high frequencies. They are a type of antiferromagnetic materials, in which the moments of the two sublattices are not equal and so do not cancel each other completely. Neel suggested that in these compounds, the spin system located in the octahedral sites is oriented antiparallel to that on the tetrahedral sites. He proposed that ferrites were particular examples of a more general type, and suggested that they should be called ferrimagnetic systems.

Because of difficulties involved in growing satisfactory single crystals, the majority of microwave measurements have been carried out with polycrystalline samples. However, some experiments have been carried out with single crystals. It is found that the most satisfactory experimental technique is that of using a spherical sample (0.03 cm. diameter). The specimen is oriented by X-ray, and is mounted at the centre of a full wavelength T.E. mode cavity in order to reduce dipole image effects, which arise, if the sample is situated near to a conducting wall. The experimental set-up otherwise is the same as was described earlier. Ferrite materials have been employed as non-reciprocal devices by placing them at an asymmetrical position within the wave guide. These

have useful applications as phase shifters and attenuators.

#### CYCLOTRON RESONANCE

The motion of charged particles under the influence of a steady magnetic field takes a spiral path, with a natural frequency which is determined by the equation

$$\omega = \frac{qH}{m^*c}$$

where  $\omega$  is the angular frequency,  $q$  is the charge,  $H$  is the magnetic field,  $m^*$  is the effective mass and  $c$  has the usual significance. The charge moves in a plane perpendicular to the magnetic field with the angular frequency  $\omega$  given above. If now an electric field of this frequency is applied in the plane perpendicular to the magnetic field, the charge will acquire energy, and this will result in a 'cyclotron' resonant absorption. This type of absorption process arises due to electric dipole transition, in distinction from a magnetic dipole transitions discussed. Cyclotron resonance absorption was first reported by Dresselhaus, Kip and Kittel in germanium crystals for both  $n$  and  $p$  types, at liquid helium temperatures. Measurements in  $p$ -type germanium, with  $10^{11}$  acceptors/c.c. showed two resonance lines corresponding to effective masses for the holes of 0.04  $m_e$  and 0.30  $m_e$ .

The experimental set-up for observing cyclotron resonance is very similar to that of the electron spin resonance, with the difference that the component of the microwave electric field should be perpendicular to the applied magnetic field. The signal intensity has been found to be dependent on microwave power level and this is due to the fact that electrons near resonance gain energy and cause ionisation, thus increasing the number of electrons available for the cyclotron resonance. Infrared illumination has been used to excite the carriers. In one method, light from a tungsten lamp is focussed on the specimen, through a hole in the microwave cavity. By chopping this light beam, a modulated absorption signal is obtained which may be suitably amplified and recorded.

It has also been found useful to measure the cyclotron resonance with circularly polarised microwave radiation. Since the sense of rotation of a carrier about the magnetic field direction depends upon the sign of its charge, circularly polarised radiation enables the electrons and holes to be distinguished.

The study of microwave absorption in solids is a fertile field for further investigations on the experimental as well as on the theoretical side. An excellent review on this subject under the title "Microwave Properties of Solids", by D. M. S. Bagguley and J. Owen has appeared in the *Reports on Progress of Physics*, Vol. XX,

1957. It is this article which prompted the author to write the above. Much experimental material has been drawn from the above article, for which grateful acknowledgement is made.

A. JAYARAMAN,

---

### INDIAN SCIENCE CONGRESS

**T**HE Forty-Fifth Session of the Indian Science Congress was held in Madras from the 6th to 12th January 1958, under the auspices of the University of Madras. The Congress was inaugurated by the Prime Minister of India Shri Jawaharlal Nehru, on the 6th. Professor M. S. Thacker, the General President for the Forty-Fifth Session, delivered the Presidential Address, on the "Advancement and Promotion of the Cause of Science in India".

After outlining briefly as to how history teaches us that science and society inevitably act and react on each other with consequences to both, Professor Thacker went on in his address to the present-day science which has emerged as a carrier of a new socialism, realistic in emphasis and rationalist in aim. Discussing the present position of Science and Technology in India, he said, "We started with the promise, which in the context of the present situation has the status of an axiom, that the rapid advancement of science and technology is a prerequisite for the development of the nation's material resources and economic welfare. On our innate ability to achieve results, there can be no doubt; we are endowed with an abundance of natural resources and we have a rich wealth of human talent; we have the tradition for objective inquiry and acquisition of knowledge. While nothing is to be gained by deploring past neglect, the awareness engendered should spur us to action and promote science and technology boldly and with determination. In a country richly endowed with human wealth, there can be no dearth of men and women gifted with curiosity and imbued with a passion for inquiry. The task is to stimulate these human endowments wherever they lie latent."

He indicated how best, the demands for personnel in the rapidly growing country could be met. He also stressed the importance of social understanding of science and concluded his address setting out the task before us. Calling upon the younger generation, he said, "Most of the onerous responsibilities will devolve on the shoulders of the younger generation and it is to this generation we look for leaders, and rank and file of builders of resurgent India. I take this opportunity to appeal to the youth of this country to rise to the occasion and equip themselves for the tasks of tomorrow."

On the 8th, 9th, 10th and 11th January, the mornings were occupied by the sectional meetings, in which scientific papers were read and the afternoons were devoted to joint discussions and symposia.

Over thirty symposia and joint discussions were held under the auspices of the different sections. The following were the Sectional Presidents: *Mathematics*: Prof. B. S. Madhava Rao; *Physics*: Professor S. L. Malurkar; *Chemistry*: Prof. S. Ghosh; *Engineering and Metallurgy*: Prof. C. S. Ghosh; *Statistics*: Dr. K. Kishen; *Agricultural Sciences*: Dr. P. N. Bhaduri; *Medical and Veterinary Sciences*: Dr. A. K. Bose; *Physiology*: Dr. S. N. Ray; *Geology and Geophysics*: Dr. A. G. Jhingran; *Botany*: Prof. T. S. Sadasivan; *Zoology and Entomology*: Dr. P. Bhattacharya; *Anthropology and Archaeology*: G. M. Kurulkar; *Psychology and Educational Sciences*: Dr. A. K. P. Sinha.

Popular lectures were delivered by eminent scientists during the Session. Over 1,700 delegates participated in this Session, of which 70 were from abroad.

---

## THE CRYSTAL STRUCTURE OF L-TYROSINE HYDROBROMIDE

R. SRINIVASAN

Department of Physics, University of Madras, Guindy, Madras-25

CRYSTALS of L-tyrosine hydrobromide,

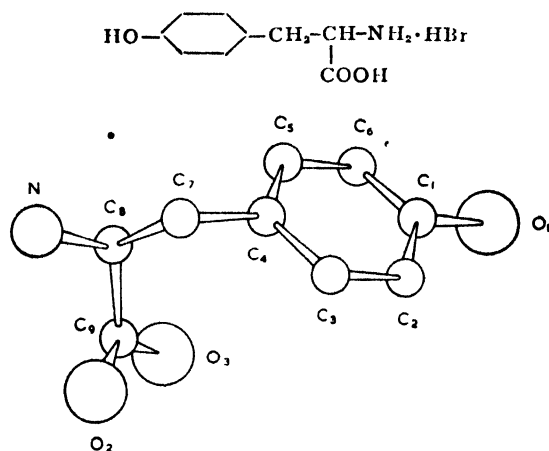
FIG. 1. View of the molecule of tyrosine projected down the *c*-axis.

(Fig. 1), obtained by treating the free compound with concentrated hydrobromic acid were found to be isomorphous with the hydrochloride. The preliminary data on these compounds have already been reported (Srinivasan, 1956). Rotation and Weissenberg photographs showed that the lattice was monoclinic with the dimensions:

$$a \text{ (\AA)} \quad b \text{ (\AA)} \quad c \text{ (\AA)} \quad (\beta^\circ) \quad V(\text{\AA}^3) \quad Z$$

L-tyrosine HBr	11.41	9.11	5.17	91.0	537.5	2
L-tyrosine HCl	11.03	9.10	5.00	90.7	501.9	2

With  $Z=2$ , the calculated density was 1.62 for the hydrobromide and 1.44 for the hydrochloride while the observed value was respectively 1.64 and 1.42 g./cm.<sup>3</sup>

In the Weissenberg photographs, only  $0k0$  reflections with  $k$  odd were systematically absent. Since the substances are optically active,  $P2_1$  is the only space group possible for both the compounds.

The intensities were estimated visually using the multiple-film technique. They were placed on an absolute scale by Wilson's method and later by comparing  $\sum |F_0|$  with  $\sum |F_c|$ . The value of  $B$  in the isotropic temperature factor  $\exp(-B \sin^2 \theta/\lambda^2)$  was found to be 2.50 and 2.35  $\text{\AA}^2$  respectively for the hydrobromide and hydrochloride. The atomic scattering factor values given by Viervoll and Ögrim (1949) were used in structure factor calculations.

## DETERMINATION OF THE STRUCTURE

The Difference Patterson (D-P) technique (Kantha and Ramachandran, 1955), was applied to solve the structure. The superposition method of Buerger (1951) was applied on the D-P projected along the *c*-axis and a satisfactory structure was arrived at. It was further confirmed by obtaining the minimum function (Buerger, 1951), with the ordinary *b*-axis Patterson function of the hydrobromide. These trial co-ordinates gave values of  $R(hk0) = 33\%$  and  $R(h0l) = 31\%$  for the hydrobromide, where  $R$  is the reliability index defined by

$$R(hkl) = \frac{\sum_{hkl} |F_0| - |F_c|}{\sum_{hkl} |F_0|}$$

The refinement proceeded by Fourier and least squares techniques. An overall anisotropic temperature factor for a particular reflection  $hkl$  was taken in the form

$$\exp(-b_{11}h^2 + b_{22}k^2 + b_{33}l^2 + 2b_{13}hl)$$

and was applied to the calculated structure factors. The parameters  $b_{11}$ ,  $b_{22}$ , etc., were also refined by the least squares method along with the co-ordinate parameters.

The final values of the reliability indices were:  $R(hk0) = 11.6\%$ ,  $R(h0l) = 12.0\%$ . If unobserved reflections (i.e.,  $F_0 = 0$ ) are omitted, the values are  $R(hk0) = 10.5\%$ ,  $R(h0l) = 10.9\%$ . These  $R$  values are for  $F_c$ 's without including the hydrogen contributions. Table I gives the atomic co-ordinates while Table II gives intramolecular and intermolecular bond lengths and bond angles.

TABLE I  
Atomic co-ordinates in L-tyrosine hydrobromide

	<i>x/a</i>	<i>y/b</i>	<i>z/c</i>	<i>x</i> (Å)	<i>y</i> (Å)	<i>z</i> (Å)
C <sub>1</sub>	0.093	0.025	0.361	1.06	0.23	1.87
C <sub>2</sub>	0.080	0.129	0.151	0.91	1.18	0.78
C <sub>3</sub>	0.972	0.130	0.020	11.09	1.18	0.10
C <sub>4</sub>	0.880	0.028	0.084	10.04	0.26	0.44
C <sub>5</sub>	0.902	0.932	0.302	10.29	8.49	1.56
C <sub>6</sub>	0.005	0.928	0.432	0.07	8.45	2.23
C <sub>7</sub>	0.760	0.033	0.938	8.67	0.30	4.85
C <sub>8</sub>	0.660	0.086	0.090	7.53	0.78	0.47
C <sub>9</sub>	0.675	0.247	0.170	7.70	2.25	0.88
O <sub>1</sub>	0.195	0.028	0.518	2.22	0.26	2.68
O <sub>2</sub>	0.643	0.343	0.010	7.34	3.13	0.05
O <sub>3</sub>	0.738	0.274	0.372	8.42	2.50	1.92
N	0.550	0.067	0.940	6.28	0.61	4.86
Br	0.4123	0.2500	0.4368	4.70	2.28	2.26

TABLE II

(a) Intramolecular bond lengths and bond angles

C <sub>1</sub> C <sub>2</sub>	1.45 (Å)	C <sub>1</sub> -C <sub>2</sub> -C <sub>3</sub>	117° 18'
C <sub>2</sub> C <sub>3</sub>	1.40	C <sub>2</sub> -C <sub>3</sub> -C <sub>4</sub>	122° 6'
C <sub>3</sub> C <sub>4</sub>	1.44	C <sub>3</sub> -C <sub>4</sub> -C <sub>5</sub>	115 30
C <sub>4</sub> C <sub>5</sub>	1.45	C <sub>4</sub> -C <sub>5</sub> -C <sub>6</sub>	122 20
C <sub>5</sub> C <sub>6</sub>	1.37	C <sub>5</sub> -C <sub>6</sub> -C <sub>1</sub>	117 30
C <sub>6</sub> C <sub>1</sub>	1.39	C <sub>6</sub> -C <sub>1</sub> -C <sub>2</sub>	122 14
C <sub>4</sub> C <sub>7</sub>	1.57	O <sub>1</sub> -C <sub>1</sub> -C <sub>2</sub>	120 0
C <sub>7</sub> C <sub>8</sub>	1.47	O <sub>1</sub> -C <sub>1</sub> -C <sub>6</sub>	116 33
C <sub>8</sub> C <sub>9</sub>	1.55	C <sub>3</sub> -C <sub>4</sub> -C <sub>7</sub>	120 26
C <sub>9</sub> O <sub>1</sub>	1.42	C <sub>7</sub> -C <sub>4</sub> -C <sub>7</sub>	121 54
C <sub>9</sub> O <sub>2</sub>	1.26	C <sub>4</sub> -C <sub>7</sub> -C <sub>8</sub>	115 57
C <sub>9</sub> O <sub>3</sub>	1.29	C <sub>7</sub> -C <sub>8</sub> -C <sub>9</sub>	110 42
C <sub>8</sub> N	1.49	C <sub>7</sub> -C <sub>8</sub> -N	108 6
		N-C <sub>8</sub> -C <sub>9</sub>	109 3
		C <sub>8</sub> -C <sub>9</sub> -O <sub>2</sub>	115 50
		C <sub>8</sub> -C <sub>9</sub> -O <sub>3</sub>	116 16
		O <sub>2</sub> -C <sub>9</sub> -O <sub>3</sub>	124 9

(b) Intermolecular distances and angles  
(See Fig. 3)

Hydrogen bonds		Angles		Short contacts	
N(M')H ... Br'	3.46 (Å)	C <sub>8</sub> -N(M')-Br'(001)	136°	Br-C <sub>9</sub> (M <sub>100</sub> )	3.30 (Å)
N(M')H ... Br'(001)	3.46	C <sub>8</sub> -N(M')-Br'	102	N(M')-O <sub>2</sub> (M <sub>101</sub> )	3.01
N(M')H ... Br'(001)	3.50	C <sub>8</sub> -N(M')-Br(001)	107	Br-O <sub>2</sub> (M <sub>100</sub> )	3.55
O <sub>3</sub> (M')H ... O <sub>1</sub> (M)	2.50	C <sub>9</sub> -O <sub>3</sub> (M')-O <sub>1</sub> (M)	112		
O <sub>1</sub> (M)H ... Br	3.23	C <sub>1</sub> -O <sub>1</sub> (M)-Br	132		

DISCUSSION OF THE STRUCTURE

The standard deviations of atomic co-ordinates were estimated using the least squares formula and were found to be almost the same for the three directions, *x*, *y*, *z* for any particular atom. The average values are 0.036 Å for

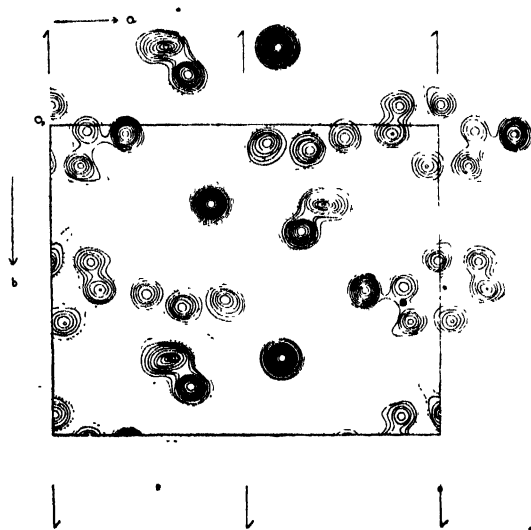

FIG. 2. Final Fourier projection of L-tyrosine hydrobromide along the *c*-axis. Contours at intervals of 0.5 e/Å<sup>2</sup>. For bromine the interval is 2.0 e/Å<sup>2</sup>. Dotted contour corresponds to 2.5 e/Å<sup>2</sup>.

carbon, 0.030 Å for nitrogen, 0.023 Å for oxygen and 0.007 Å for bromine atoms. The standard deviation in bond lengths using the above values are found to be 0.05 Å for C-C, 0.047 Å for C-N, 0.045 Å for C-O, and 0.034 Å for O-O distance. The error in bond angles is about 3°.

The Fourier projection along the *c*-axis is shown in Fig. 2 and can be compared with the molecule projected along the same axis (Fig. 3).

The bond lengths and angles are quite normal, judged from the values of the standard deviations. The benzene ring is planar, the largest deviation from the plane being 0.028 Å. The group C<sub>8</sub>C<sub>9</sub>O<sub>2</sub>O<sub>3</sub> is also planar as found in other amino acids. The distance of nitrogen from this plane is 0.62 Å.

The molecules are arranged in sheets parallel to (010) (Fig. 3). They are held together by a system of hydrogen bonds of the type

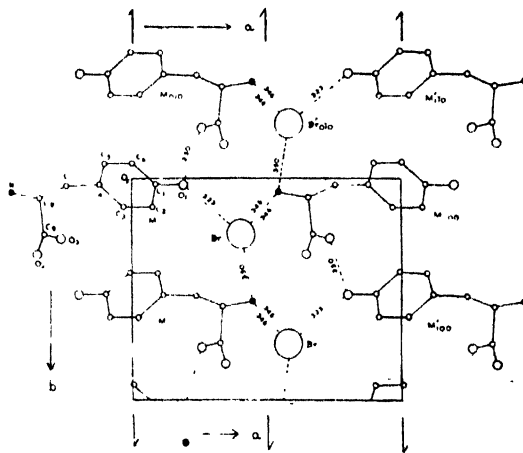

FIG. 3. One unit cell of L-tyrosine hydrobromide projected down the *c*-axis. Hydrogen bonds are shown by dotted lines. The bond lengths are in Å.

NH...Br, OH...Br and OH...O. The three NH...Br bonds from the nitrogen of the NH<sub>3</sub><sup>+</sup> group are of lengths 3.46, 3.46 and 3.50 Å and are also making approximately tetrahedral angles with C<sub>8</sub>N (101°, 136° and 107°). The OH...O bond (2.50 Å) is short compared with that found in other amino acids. There is also an OH...Br bond of length 3.23 Å. The

hydrogen bond distances and angles are listed in Table II.

Details of the investigations will be published elsewhere in due course.

The author wishes to acknowledge his grateful thanks to Professor G. N. Ramachandran

for helpful guidance during these investigations.

1. Buerger, M. J., *Acta Cryst.*, 1951, 4, 531.
2. Kartha, G. and Ramachandran, G. N., *Ibid.*, 1955, 8, 1955,
3. Srinivasan, R., *Ibid.*, 1956, 9, 1039.
4. Viervoll, H. and Ögrim, O., *Ibid.*, 1949, 2, 277.

#### MARINE BIOLOGICAL STATION, PORTO NOVO (S. INDIA)

**A** BIOLOGICAL STATION on the banks of Vellar estuary at Porto Novo had been the dream of the Zoology Department of the Annamalai University ever since its inception in 1931. The station however came into being only in 1951 with some improvised equipment, and was located in a tenanted building, situated close to the foreshore at Porto Novo, which was transferred later to the University, as a generous gift by the South Arcot District Board for the development of a marine biological station. Financial aid came first from the Ministry of Education, New Delhi, and later from the Madras State Government for the development of the station.

This enabled the University to adequately equip the station with oceanographic instruments, cruising boats including a sturdy seaworthy 35 ft. research vessel equipped with apparatus for investigations in fundamental as well as applied aspects of marine and estuarine biology.

A newly constructed annex to the building, which was recently declared open by Dr. C. D. Deshmukh, provides moderate accommodation for a hydrobiological laboratory, an aquarium, ichthyological museum, and also for certain lines of biochemical and biophysical work.

With its proximity to the sea, the estuary, the fresh-water head, and the backwaters connecting with the Coleroon, the Porto Novo Biological Station has especially good opportunities for distinctive lines of work relating to the evolution of biochemical adaptations in organisms, and for gaining a comparative picture of the basic factors that control the productivity of different waters.

The work at the biological station has so far been in what may be termed 'hobby spirit', and as a side activity of the Zoology Department, without any special and permanent staff. However, several cruises have been conducted in the sea as well as in the estuary, and valuable data systematically recorded. Planktonic studies, faunistic surveys, observations on tidal cycles and transmission of different wavelengths of radiant energy in the neritic and estuarine waters have been a routine aspect of the work of the Porto Novo Biological Station. The bottom fauna of the estuary and the inshore waters has been dredged and its ecology is under investigation. The consolidation of the results of all these studies is in progress.

Apart from the routine lines of work, the investigation of the biochemical aspects of the reproductive cycles of certain estuarine fish and the quantitative study of the amino acids of the fishes of Porto Novo have been in progress for some time, and the role of some trace elements in estuarine ecology and the ionic regulation in some of the estuarine molluscs and fish are on the current programme of study.

With generous and substantial encouragement from the University Grants Commission, with the keen interest evinced by the authorities of the Annamalai University, and also with a capital of zeal, industry and spirit of intellectual enterprise, the Porto Novo Biological Station hopes to soon augment its facilities, and intensify its research activities.

## MOULDS, METABOLITES AND TISSUES\*

WITHIN the last quarter of a century, experimental plant pathology, particularly dealing with pathogenic fungi and their host plants has shot up into great prominence. Physiology of fungi, *in vitro*, and the physiology of the host tissue under the influence of products of metabolism of these tiny microscopic forms, now termed collectively, as toxins or antibiotics, have been studied intensely in many centres of research. Many fungi have been screened for antibiotic production and those of interest to us are the wilt toxins.

## TOXINS AND ANTIBIOTICS

An important wilt toxin known to affect cotton plants in India is fusaric acid which is a pyridine-carboxylic acid with a molecular weight of 179 and the unsaturated dehydrofusaric acid with a close enough molecular weight of 177. Both these forms are known to occur inside plant tissues when they are invaded by several species of the common soil organisms of the genus *Fusarium*. It is, however, not known if these two fractions are produced independent of each other, although it has been noticed that the unsaturated dehydrofusaric acid is produced earlier than the saturated fusaric acid molecule. Fusaric acid is known to be produced notably by *Fusarium lycopersici* (the tomato wilt pathogen), *F. vasinfectum* (the cotton wilt pathogen), the non-specific *F. heterosporum* and quite recently, much higher quantities are shown to be produced by a weak parasite, *F. orthoceras*. Another genus *Gibberella fujikuroi* is also known to produce fusaric acid, dehydrofusaric acid and two substances of the Gibberellin group that are known to have the character of growth substances. The *in vitro* requirements of these fungi in the shape of carbon and nitrogen for optimum production of the antibiotic have been worked out and the main factors contributing towards this are the form and sources of carbon and nitrogen and the pH of the substratum.

## RHIZOSPHERE AND FUNGAL METABOLISM

There is great deal more to learn about pathogenic fungi and their behaviour in the region of the root (rhizosphere). For instance, the cotton wilt fungus, *Fusarium vasinfectum* which takes a heavy toll of this crop plant in many cotton-growing areas in India, has been estab-

lished by us as a typical soil inhabitant of these soils, and, indeed, as many as fourteen species of this genus are now known to be present in such soils. There seems little doubt that they are primary decomposers of cellulose in the soils. We have also noticed the occurrence in soils of two other species, *F. lateritium* and *F. scirpi* known to produce wilt of tomato. The typical organism causing tomato wilt in other parts of the world is *F. lycopersici* through its wilt toxin fusaric acid and *F. lateritium* and *F. scirpi* recorded by us as potential pathogens of the tomato are not known to produce this toxin. Quite recently we have succeeded in showing that a weak parasite *F. orthoceras* could produce considerable quantities of fusaric acid, far in excess of what the cotton wilt pathogen *F. vasinfectum* can produce.

In the rhizosphere, many organisms, pathogens and saprophytes, have been noticed and, in fact, they have been quantitatively assessed. These organisms obviously depend on the root exudates that can afford an unfailling substrate of energy material in the form of sugars, vitamins and amino acids. The pathogenic forms of the soil have been shown by many workers to produce *in situ* antibiotics and these remain stable in many cases for considerable periods. We have been able to show that *F. vasinfectum* in sterilized soils amended with stable organic matter like green leaf and oats produces the equivalent of fusaric acid upto 2.9 and 7.9  $\mu\text{g./g.}$  of soil respectively. Our work has also indicated that this organism can be induced to produce mutants under ultraviolet irradiation of 2537 A with a total energy less than  $24.73 \times 10^7$  ergs and some of these mutants are capable of synthesizing greater quantities of fusaric acid *in vitro* than the parent culture.

## ENERGY SUBSTRATES

One of the heavy metals required by *F. vasinfectum* for normal production of fusaric acid *in vitro* is zinc and as far as we can determine, using stringent bioassay methods, fusaric acid is not formed with concentrations of the metal below 0.08 mg./l., the optimum being 0.24 mg./l. and levels higher than 0.4 mg./l. inhibit the production of the antibiotic. This work has direct bearing on the field problem of wilt as we have been able to show that in soils where cotton wilt by *F. vasinfectum* occurs freely, there is lower level of Zn than in those that harbour the pathogen but yet show no typical wilt and, indeed, these soils have much higher content of this metal.

\* Abstract of the Presidential Address by Prof. T. S. Sadasivan to the Section of Botany of the 45th Indian Science Congress, Madras, 1958.



## SOIL CONDITIONS AND HOST PHYSIOLOGY

It is obvious that the wilt fungus requires *in vivo* metals, pectins and presumably a good source of nitrogen. We have examined both resistant and susceptible varieties of cotton plants for their nitrogen source and find that their protein nitrogen and non-protein nitrogen contents differ very widely and the susceptible varieties make available large quantities of non-protein nitrogen *in vivo* upon which the fungus toxin development largely depends. This is borne out by *in vitro* tests where the fungus has been shown to depend upon non-protein nitrogen sources for elaboration of toxins. Similarly, *in vivo* pectin source is greater in the roots of the susceptible, than in the resistant varieties tried by us and possibly is another *in vivo* energy source on which the pathogen depends for developing its twin enzyme systems, the pectin methylesterase and pectin galacturonase without which the organism could not synthesize the toxin.

## ENVIRONMENT, TOXÆMIA AND TISSUE RESPIRATION

One of the *in vivo* causes of resistance to the cotton wilt pathogen we have ascribed, over and above what has been stated already, is the presence of cystine only in resistant plants. There are two ways, as far as we have data, of inducing susceptible plants to produce cystine and create an artificial barrier of resistance. This can be done by zinc amendments to soils where these plants are grown or by growing susceptible cottons at a temperature of 37.5° C.

The possibility of the fusaric acid molecule splitting at the high temperature of incubation

of 37.5° C. and being utilized for respiratory purposes of the plant tissue suggests itself as an alternative explanation. It could also indicate the *in vivo* chelation of heavy metals with cystine thus withdrawing these metals which are vital for potentiation of the toxin fusaric acid. One of the effects of Zn amendment appears to be that of retarding tissue respiration of susceptible cotton plants grown in Zn amended infested soils and bringing it down to the normal level of the healthy control. This is interesting, because increased respiration of tissues of cotton grown in infested soils seems to be the major change with onset of toxæmia and the role of Zn in nullifying these effects has to be further explored.

## WILT AND IONIC DERANGEMENT

Some of the newer results in our investigations on the uptake of ions and their derangement in wilted susceptible cotton plants indicate that apart from loss in K and an increase in Mn *in vivo*, there is strong evidence of the appearance of ionized calcium during pathogenesis. Although the resistant plant also shows ionized calcium lines nearly as strong as the susceptible plant under toxæmia, the healthy susceptible plant shows very weak ionized calcium lines. Therefore, Ca ionization is essentially ascribable to the possible dissociation of the fusaric acid molecule *in vivo* and the consequent changes it could have brought about in the respiration and in the ionization of the neutral calcium. This evidence is suggestive of a poisoning effect of the tissues resulting in major ionic derangement *in vivo*.

## A GEOCHEMICAL HYPOTHESIS OF THE EARTH'S STRUCTURE

THE view that the Earth is zonal in its structure, with each zone characterised by certain dominant elements has long prevailed in geochemistry. These views in recent years have been examined and it is considered that a chemically homogeneous non-zonal globe is much more probable.

The hypothesis is based on the fact that the behaviour of matter would be totally different from that observed on the crust of the Earth. In the interior where the pressure is hundreds of thousands of atmospheres, the outer electrons are forced into the lower quantum levels. At a depth of 2,900 Km. the pressure is of the order of 1,400,000 atoms, and

calculations show that at the high pressure prevailing at this depth, all atoms will become identical, in respect of their chemical behaviour. Thus, it is assumed that at the high pressure prevailing at this depth, called the 'centrisphere' all atoms will be in a 'metallised' state, in which matter will be made up of atomic nuclei immersed in a homogeneous electronic plasma, having a high electrical and thermal conductivity. This geochemical hypothesis of the structure of the Earth finds support in certain thermodynamic considerations and seems to agree with the seismological data. (A. F. Kapustinsky. *Nature*, 1957, 180, 1245.)

## LETTERS TO THE EDITOR

### A NEW METHOD FOR THE SEPARATION OF SOLS FROM SOL-MIXTURES

THE chromatographic separation of various substances, present in the ionic or molecular state in solution in suitable solvents, has been carried out with conspicuous success in recent years. The important methods previously developed involve (a) adsorption, (b) ion-exchange, and (c) partition chromatography. In view of the importance of colloids in science and industry, it appeared to us desirable to evolve a method of separating and identifying the colloidal constituents in mixtures of sols. An admixture of oppositely charged sols brings about mutual coagulation. Consequently separation of sols, carrying like charges, from their mixtures can only be considered. It is evident that the usual methods of adsorption, ion-exchange and partition chromatography cannot be applied in the case of sols. We have therefore worked out the following method, which was found to be quite successful in the separation of the constituents from a mixture of three or more sols.

A Whatman's filter-paper strip was soaked in a dilute aqueous solution of a suitable electrolyte (KCl, BaCl<sub>2</sub> or K<sub>2</sub>SO<sub>4</sub> depending upon the nature of the sols used) and dried. The paper strip thus prepared was moistened immediately before the experiment and held horizontally on a suitable support consisting of glass rods, and one end of it was immersed in the mixture of sols contained in a small dish while the other end was immersed in a solution of the electrolyte. A suitable electrical potential (say about 3 to 12 volts/cm.) was applied across two electrodes, made of platinum foil, which were immersed in the sol-mixture and electrolyte solution respectively, so as to cause the electrophoretic migration of the sols along the filter-paper. The particles of the different sols adsorb ions from the electrolytic solution in the filter-paper to different extents and acquire electrical charges of differing magnitudes although of the same sign, and consequently migrate through the paper with unequal speeds, resulting in a clear separation of the different kinds of sols in the course of three to six hours. Depending upon the electrical charge originally associated with the sol-parti-

cles, the electrolyte may cause the coagulation of any one of the sols, thus making the separation of sols much sharper. The presence of the electrolyte in the moistened filter-paper strip further helps in increasing the conduction of the current and facilitates the migration of the sols.

The separation of a number of sol-mixtures has been effected by this method. The result obtained in the case of the separation of antimony sulphide, mercury sulphide and Prussian blue sols is shown in Fig. 1. The

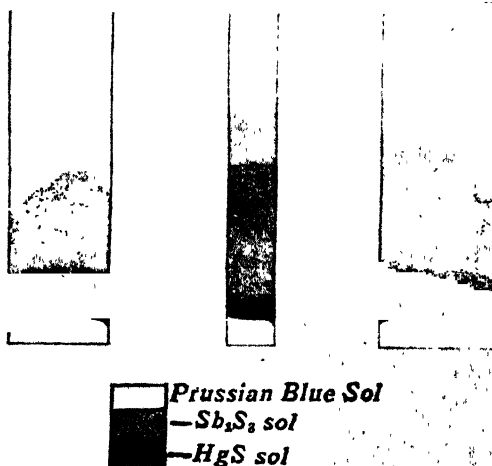

FIG. 1

method worked out by us is of general application to all sol-mixtures and should thus be of interest, as it reveals in the course of a few hours the various constituents of sol-mixtures.

Chemical Labs.,

K. KRISHNAMURTI.

College of Science,

B. V. DHARESHWAR.

Nagpur, October 14, 1957.

### LATTICE PARAMETERS AND CRYSTALLOGRAPHIC ANGLES OF HEXAGONAL COBALT

No attempt has so far been made to determine accurately the lattice parameters of close-packed hexagonal  $\alpha$ -cobalt as annealed cobalt powder is normally a mixture of the  $\alpha$  and the face-centred cubic  $\beta$  phases and most X-ray reflections from the  $\alpha$  phase are broadened by stacking faults in the basal planes. In the

course of some recent investigations on the structural irregularities of  $\alpha$ -cobalt, the author was able to obtain annealed filings of pure cobalt containing only traces of the  $\beta$  phase and practically free from stacking faults in the  $\alpha$  phase. The filings were taken from a large-grained cobalt block melted and cooled slowly *in vacuo*. They were annealed *in vacuo* for a few weeks at 375° C., a temperature well below the phase transformation temperature of 420° C. A powder photograph of the annealed filings was taken at 20° C. with a 19 cm. Debye-Scherrer X-ray camera, and the diffraction

pattern showed clearly resolved doublets of the 11 $\bar{2}2$ , 0004 and 2023 reflections, the last one being normally appreciably broadened by stacking faults. Using Nelson and Riley's function<sup>1</sup> of  $\theta$  for extrapolation, the following lattice parameters were arrived at:

$$a = 2.5071 \text{ \AA}$$

$$c = 4.0686 \text{ \AA}$$

$$c/a = 1.6228$$

The crystallographic angles of hexagonal cobalt (with  $c/a = 1.6228$ ) calculated from the equation:

$$\cos \phi = \frac{h_1 h_2 + k_1 k_2 + \frac{1}{2} (h_1 k_2 + h_2 k_1) + \frac{1}{2} \frac{a^2}{c^2} l_1 l_2}{\left[ (h_1^2 + k_1^2 + h_1 k_1 + \frac{1}{2} \frac{a^2}{c^2} l_1^2) (h_2^2 + k_2^2 + h_2 k_2 + \frac{1}{2} \frac{a^2}{c^2} l_2^2) \right]^{\frac{1}{2}}}$$

where  $\phi$  is the angle between  $h_1 k_1 i_1 l_1$  and  $h_2 k_2 i_2 l_2$  planes, are given in Table I.

TABLE I  
Crystallographic Angles of Hexagonal Cobalt  
( $c/a = 1.6228$ )

(0001) to (10 $\bar{1}3$ )	.. .. 11° 46'	(0001) to (11 $\bar{2}$ 10)	.. .. 17° 59'
(10 $\bar{1}8$ )	.. .. 13° 11'	(11 $\bar{2}$ 8)	.. .. 22° 5'
(10 $\bar{1}7$ )	.. .. 14° 59'	(11 $\bar{2}$ 6)	.. .. 28° 25'
(10 $\bar{1}6$ )	.. .. 17° 21'	(22 $\bar{4}$ 10)	.. .. 33° 0'
(10 $\bar{1}5$ )	.. .. 20° 33'	(11 $\bar{2}4$ )	.. .. 39° 4'
(20 $\bar{2}9$ )	.. .. 22° 37'	(22 $\bar{4}6$ )	.. .. 47° 15'
(10 $\bar{1}4$ )	.. .. 25° 6'	(11 $\bar{2}2$ )	.. .. 58° 22'
(20 $\bar{2}7$ )	.. .. 28° 10'	(22 $\bar{4}2$ )	.. .. 72° 53'
(10 $\bar{1}3$ )	.. .. 32° 0'	(11 $\bar{2}0$ )	.. .. 90° 0'
(20 $\bar{2}5$ )	.. .. 36° 51'	(0001) to (21 $\bar{2}5$ )	.. .. 44° 46'
(10 $\bar{1}2$ )	.. .. 43° 8'	(21 $\bar{2}4$ )	.. .. 51° 6'
(30 $\bar{3}5$ )	.. .. 48° 21'	(21 $\bar{2}3$ )	.. .. 58° 50'
(20 $\bar{2}3$ )	.. .. 51° 20'	(21 $\bar{2}2$ )	.. .. 68° 2'
(30 $\bar{3}4$ )	.. .. 54° 34'	(21 $\bar{2}1$ )	.. .. 78° 36'
(10 $\bar{1}1$ )	.. .. 61° 55'	(21 $\bar{2}0$ )	.. .. 90° 0'
(30 $\bar{3}2$ )	.. .. 70° 25'	(10 $\bar{1}0$ ) to (23 $\bar{5}0$ )	.. .. 36° 35'
(20 $\bar{2}1$ )	.. .. 75° 4'	(12 $\bar{3}0$ )	.. .. 40° 54'
(30 $\bar{3}1$ )	.. .. 79° 55'	(25 $\bar{7}0$ )	.. .. 43° 54'
(10 $\bar{1}0$ )	.. .. 90° 0'	(13 $\bar{4}0$ )	.. .. 46° 6'
(10 $\bar{1}0$ ) to (51 $\bar{6}0$ )	.. .. 8° 57'	(14 $\bar{5}0$ )	.. .. 49° 6'
(41 $\bar{5}0$ )	.. .. 10° 54'	(15 $\bar{6}0$ )	.. .. 51° 3'
(31 $\bar{4}0$ )	.. .. 13° 54'	(01 $\bar{1}0$ )	.. .. 60° 0'
(52 $\bar{7}0$ )	.. .. 16° 6'	(12 $\bar{1}0$ )	.. .. 90° 0'
(21 $\bar{3}0$ )	.. .. 19° 6'		
(32 $\bar{5}0$ )	.. .. 23° 25'		
(11 $\bar{2}0$ )	.. .. 30° 0'		

The experimental part of this work was done at the Inorganic Chemistry Laboratory of the University of Oxford and the author would like to thank Dr. J. W. Christian of the same Laboratory for his interest in this investigation. The author's thanks are also due to Prof. A. A. Krishnan, Head of the Department of Metallurgy, Indian Institute of Science, for his interest in this publication.

Dept. of Metallurgy, T. R. ANANTHARAMAN.  
Indian Institute of Science,  
Bangalore-3, November 14, 1957.

1. Nelson, J. B. and Riley, D. P., *Proc. Phys. Soc.*,  
1945, 57, 100.

### HEAT OF WETTING OF CHARCOAL IN RELATION TO CHEMISORBED OXYGEN

As pointed out by Boyd and Jarkins,<sup>1</sup> hydrophilic solids containing oxygen such as silica gel and titanium dioxide give higher heats of immersion in water than hydrophobic solids such as graphon and graphite. Adsorbent carbons and charcoals provide interesting materials for such studies because even though they are basically hydrophobic, their surface behaviour can be modified appreciably in the presence of combined oxygen. The present work was, therefore, attempted.

Coconut shell and sugar charcoals, free of ash, were degassed at different temperatures in order to eliminate increasing amounts of chemisorbed oxygen. The amount of oxygen retained and its disposition as CO<sub>2</sub>, CO and H<sub>2</sub>O was determined by careful analysis of the gases evolved<sup>2</sup> on high temperature (1,200° C.) evacuation. The value for total oxygen was confirmed by ultimate analysis in a few cases. Surface areas calculated from water isotherms<sup>3</sup> remained unchanged in conformity with previous observations.<sup>3,4</sup> The heats of immersion (ergs/cm.<sup>2</sup>) in ethyl alcohol and benzene were found to be almost independent of the combined oxygen. Average values were 215 and 150 ergs/cm.<sup>2</sup> respectively.

However, the values in water varied appreciably. It is seen (Table I) that the heat of immersion in water goes on decreasing on evacuating upto 700° as does the amount of oxygen disposed as CO<sub>2</sub>, but thereafter on further evacuation at higher temperatures, although total chemisorbed oxygen decreases from about 7% to nil in both the charcoals, heat of wetting remains almost unchanged. Thus it is the oxygen disposed as CO<sub>2</sub> and not total oxygen, as reported by Kraus<sup>5</sup> in the case of carbon blacks, which affects the heat of wetting of charcoal in water. However, he had examined 9 samples only, had not ascertained the disposition of the combined oxygen and quite a few points (out of 9) did not fit on his graph.

TABLE I

Heat of wetting of charcoal in water in relation to chemisorbed oxygen disposed as CO<sub>2</sub>

Description of the sample	Combined oxygen (g./100 g.) disposed as				Heat of wetting (ergs/cm. <sup>2</sup> ) <sub>2</sub>	Ba(OH) <sub>2</sub> adsorbed (m.e./100 g.)
	CO <sub>2</sub>	CO	H <sub>2</sub> O	Total		
Sugar charcoal before evacuation ..	9.84	8.57	7.62	26.03	196.7	610.2
do. evacuated at 300	5.79	8.62	6.84	21.25	139.2	360.4
do. do. 400	4.32	8.59	6.37	19.28	117.8	268.5
do. do. 500	1.83	8.48	4.60	14.91	82.9	111.9
do. do. 600	0.97	7.10	2.71	10.84	73.3	58.3
do. do. 700	0.22	6.24	1.24	7.70	60.3	14.1
do. do. 800	nil	3.97	0.24	4.21	56.7	nil
do. do. 900	nil	1.18	nil	1.18	57.2	nil
do. do. 1000	nil	0.19	nil	0.19	56.8	nil
do. do. 1200	nil	nil	nil	nil	56.4	nil
Coconut shell charcoal before evacuation ..	6.40	6.74	5.92	19.06	143.8	392.8
do. evacuated at 300	5.05	6.72	5.76	17.53	128.0	310.2
do. do. 400	1.29	6.76	4.83	12.88	75.8	73.4
do. do. 500	0.73	6.69	3.95	11.37	68.1	39.8
do. do. 600	0.32	6.27	2.76	9.35	64.3	17.6
do. do. 700	nil	5.93	1.28	7.21	59.8	nil
do. do. 800	nil	3.36	0.36	3.72	57.9	nil
do. do. 900	nil	1.14	nil	1.14	56.8	nil
do. do. 1000	nil	nil	nil	nil	56.8	nil

The base adsorption capacity of charcoal (Table I) is also seen to vary with the oxygen disposed as CO<sub>2</sub> and not with total oxygen as considered by some workers.<sup>6,7</sup> The same was the case with the adsorbability of water vapour. These observations show that it is the oxygen disposed as CO<sub>2</sub> which largely affects the acid behaviour, polar nature and hydrophilic character of charcoal and indicate the importance of determining the disposition of the combined oxygen in properly understanding the surface behaviour of carbons.

Dept. of Chemistry,  
Panjab University,  
Hoshiarpur,  
November 15, 1957.

BALWANT RAI PURI.  
D. D. SINGH.  
LEKH RAJ SHARMA.

1. Boyd, G. E. and Harkins, W. D., *J. Am. Chem. Soc.*, 1942, **64**, 1190.
2. Puri, B. R., Myer, Y. P. and Sharma, L. R., *Chemistry and Industry, B.I.F. Review*, 1956, **30**.
3. Mc Dermot, H. L. and Arnell, J. C., *J. Phys. Chem.*, 1954, **58**, 492.
4. Emmet, P. H. and Anderson, R. B., *J. Am. Chem. Soc.*, 1945, **67**, 1492.
5. Kraus, G., *J. Phys. Chem.*, 1955, **59**, 343.
6. Weller, S. and Young, T. F., *J. Am. Chem. Soc.*, 1948, **70**, 4155.
7. Wilson, J. H. and Bolam, T. R., *J. Colloid Sci.*, 1950, **5**, 550.

#### A WATER GAP OF AN UNUSUAL ORIGIN ACROSS ARCHÆAN- CUDDAPAH BOUNDARY

KING<sup>1</sup> mentions about the existence of five rivers across the Archæan-Cuddapah boundary, namely, Penn-air (present Penner), Chitravutty (Chitravati), Paupugnee (Papaghni), Mundaveer (Mandavi), and Chey-air (Chey-yeru). All these flow from the south to the north quite a considerable distance from about 30 to 100 miles over the Archæans, before entering the Cuddapah Basin. Every one of them at the entrance into the Basin presents gorges of different magnitude.

During the course of geological fieldwork along the Archæan-Cuddapah boundary, a gorge was met with 6 miles SSW of Pulivendla (Lat. 14° 25' 20" and Long. 78° 13' 50") near the village Kanampalle in Cuddapah District. The geological boundary runs roughly NW-SE in this region, with the Archæans to the south. A stream flows through the gorge from the south to the north, known as Pulivendla Vanka. The height of the steep portion of the gorge cut out by the stream is about 150' near the south, the actual unconformable contact between the Archæan granites and the Cuddapah quartzose

sandstones being very well seen midway in the gorge.

Every one of the other rivers cutting across this geological boundary at other places has more or less reached a mature stage and flows gently in its respective water gap, whereas even within the gorge here, this stream is found to flow in rapids showing its youthful stage.

Graphs on the lines suggested by Miller<sup>2</sup> were drawn to bring out the amplitude of relief of the rivers Chitravati, Pulivendla Vanka, Papaghni and Chey-yeru for a total distance of five miles extending partly on either side of the Archæan-Cuddapah boundary. The outcome was revealing in that, while the fall in the case of rivers Chitravati, Papaghni and Chey-yeru was 30, 65 and 20' respectively within this distance, the fall in the case of this stream was found to be 530'.

In the field three more small streams, west of this, were seen on the same range, which have cut deep channels within the sandstones, exhibiting migration due to headward erosion. If any one of these by prolonged headward erosion manages to capture any other stream flowing south over the Archæans, on the other side of the range, then a stream of the nature under study will result.<sup>3</sup>

Hence on these three evidences it is surmised that this water gap is due to the headward erosion of a normal consequent stream with a possible river capture.

My grateful thanks are due to Prof. C. Mahadevan for introducing me to this interesting subject of study.

Geology Dept.,  
Andhra University,  
Waltair, November 6, 1957.

R. VAIDYANADHAN.

1. King, W., *Mem. Geol. Surv. Ind.*, 1872, **8**, 31.
2. Miller, A. A., *The Skin of the Earth*, Methuen & Co., London, 1953, p. 61.
3. Davies, W. M., *Geographical Essays*, Dover Publications, 1954, p. 417.

#### A NOTE ON PARTIAL PARTHENO- CARPY IN THE GENUS *LUFFA*

DURING the course of investigations on the morphological studies in the genus *Luffa*, partial parthenocarpy was observed to occur in *Luffa acutangula* Roxb., *L. cylindrica* (Lour.) Roem. and their hybrids.

With a view to test the extent of parthenocarpy, 50' female flowers were bagged in each case. These, however, failed to set any fruit, showing thereby that complete parthenocarpy does not occur in these species and their hybrids.

An examination of the seeds of naturally set fruits, however, showed the presence of many deformed seed-coats, which were either collapsed or inflated. Most of the seeds were without embryos while in some cases, the embryos were found to be partially developed and undifferentiated. The results of this study are summarised in Table I.

TABLE I  
Showing the percentage of parthenocarpic seeds

Material	Type	Av. No. of normal seeds per fruit	Av. No. of imper- of partheno- fect seeds	Percentage of carpic seeds
<i>L. acutangula</i>	T <sub>3</sub>	43.0	30.5	41.49
	T <sub>4</sub>	20.0	50.0	71.42
	T <sub>12</sub>	42.0	14.0	25.00
<i>L. cylindrica</i>	T <sub>17</sub>	86.6	48.6	37.04
	T <sub>18</sub>	110.0	160.0	59.25
	T <sub>21</sub>	120.0	2.0	1.63
Interspecific	H <sub>40</sub>	61.5	11.5	15.75
Hybrids	H <sub>41</sub>	38.6	35.3	47.76

A perusal of the Table shows the presence of empty seeds to the extent of 71.42% in *L. acutangula*, 59.25% in *L. cylindrica* and 47.76% in the hybrids. The empty seeds were found along with the normal seeds, showing thereby that the fertilization of the ovules producing the latter was sufficient to induce the development of the fruit. It represents a clear case of partial parthenocarpy, as is met with in other cucurbits. It was further found that in the interspecific hybrids between *L. acutangula* × *L. cylindrica* (Pathak and Singh, 1949), pollens viable to the extent of only 20%, are sufficient to induce normal fruit setting.

Govt. Horticultural Res. Inst., S. N. SINGH.  
Saharanpur, U.P., September 19, 1957.

1. Pathak, G. N. and Singh, S. N., "Studies in the Genus *Luffa*. I. Cyt genetic investigations in the interspecific hybrid *L. cylindrica* × *L. acutangula*," *Indian J. Genet. & Plant Breed.*, 1949, 9 (1), 18-26.

**A NOTE ON THE FOOD AND FEEDING HABITS OF *CLUPISOMA GARUA* (HAMILTON) AND *EUTROPIICHTHYS VACHA* (HAMILTON) FROM ALLAHABAD (U.P.)\***

THE schilbeid species, *Clupisoma garua* (Ham.) and *Eutropiichthys vacha* (Ham.) together form a sizeable fishery of considerable importance at Allahabad. They are medium-sized catfishes and according to Day (1889) attain total lengths upward of 2' and 1' respectively. Mac-

Donald (1946) has recorded *E. vacha* upto 5½ lb. in weight. Hora (1937 a, b) described the qualities of these two species as game fishes of some renown. The present note is a preliminary statement on the food and feeding habits of these two valuable food fishes. The stomach contents of 621 specimens of *C. garua* and 502 of *E. vacha* were examined in detail both qualitatively and quantitatively and studies made on the intensity of feed with seasonal variations in the diet.

*C. garua*.—It feeds mostly on insects (40.8%). The terrestrial insects\* (mostly adults, 20.7%) are represented by orders Plecoptera (12.2%), Coleoptera (5.2%), Orthoptera (cockroaches, locusts, grasshoppers and mantis, 3.0%), Hymenoptera (ants, bees, wasps, 0.1%) and Isoptera (0.2%). The aquatic insects (mostly larvæ and nymphs, 6.6%) are represented by orders Diptera (2.4%), Coleoptera (1.6%), Ephemeroptera (1.2%), Odoneta (0.9%), Hemiptera (notonecta, corixa, ranatra, 0.4%) and Trichoptera (0.1%). The digested insect matter in the stomach contents made up 13.5% of the total feed.

Teleosts, represented by nine species, forms only 3.1% of the feed. The presence of animal flesh (8.3%) during certain months only, is interesting and is suggestive of carrion feeding habits of the fish. *C. garua* also subsists to a certain degree on Mollusca (1.1%) and Crustacea (1.1%). The presence of algæ and fragments of higher aquatic plants (0.7%) appears to be only incidental. The mucus (23.5%) in the stomach contents might be due to the fish subsisting mainly on insects which are known to stimulate secretion of mucus in the stomach. Considering the bulk of debris (21.1%) made up with mud, sand, stones, pebbles, charcoal pieces, etc., and the varied nature and composition of the feed, it would appear that *C. garua* feeds mostly at bottom and along margins of the river and is not of selective feeding habits but subsists on anything and everything available in the habitat.

*E. vacha*.—It feeds mostly on insects and teleosts which together account for over 70% of the total feed. Mucus (19.05%) was generally found to be associated when the fish had subsisted mainly on insects, specially the terrestrial forms. When teleosts formed the principal food, as in the later monsoon months, formation of mucus in stomachs was comparatively low. The terrestrial insects (mostly adults, 16.06%) are mainly represented by orders Plecoptera (14.48%) and Coleoptera (1.22%). The other forms, represented by orders Orthoptera, Hymenoptera and Isoptera, together

account for only 0.36%. The aquatic insects (mostly nymphs and larvæ, 12.88%) are represented mainly by orders Coleoptera (6.33%), Diptera (3.18%), Odoneta (1.56%) and Ephemeroptera (1.39%). The other aquatic forms (e.g., damsel-fly, water bug, etc.) together made up only 0.88%. The digested insect matter in the stomach contents made up 8.71%. Among the teleosts (32.5%) fourteen species are identified of which *Aspidoparia morar*, *Puntius ticto*, *Puntius conchonus* and *Mastacembalus armatus* are more commonly encountered than others. One solitary case of cannibalism was observed in the month of May 1954. *E. vacha* also subsists to a certain degree on prawns (1.54%) and Ostracods (0.71%).

The bulk of debris (5.85%) forming an important item in the stomach contents of *E. vacha* is mostly formed of wheat and/or rice husk, gram, legume seed and pod, etc., which are generally found along margins of the river. Sand, stones, pebbles and mud are also frequently encountered (2.56%). The nature of food items and the composition of debris seem to suggest that *E. vacha* is a surface and marginal feeder and perhaps observes a somewhat selective feeding. The mouth is terminal, wide and with sharp-pointed teeth and appears to be suited for the type of prey it subsists on.

The condition of the feed in the two fishes shows that *C. garua* feeds actively in April to June and September to December; *E. vacha* feeds actively in April to July and September to November. However the dietary habits of the two fishes tend to suggest that there is not much competition between the two for food requirements.

The details of this study with other aspects of the fishery biology of *C. garua* and *E. vacha* are being published elsewhere.

We are extremely grateful to Dr. B. S. Bhimachar and Dr. V. G. Jhingran for their constant encouragement during the course of these studies.

Central Inland Fisheries M. P. MOTWANI.  
Res. Substation, S. J. KARAMCHANDANI.  
Allahabad, November 13, 1957.

\* Published with the permission of the Chief Research Officer, Central Inland Fisheries Research Station, Calcutta.

1. Day, F., *Fishes of India*, London, 1890.
2. Hora, S. L., *J. Bombay Nat. Hist. Soc.*, 1937 a, 39, 431-46; *Ibid.*, 1937 b, 39, 659-78.
3. MacDonald, A. S. J., *Circumventing the Mahseer and Other Sporting Fish in India and Burma*, Bombay, 1946.

### CYTOCHEMICAL STUDIES ON THE OOCYTES OF THE TERMITE QUEEN *ODONTOTERMES REDEMANNI* (WASMANN)

SOME interesting changes in the cellular morphology of the oocytes, at different stages of development, in the ovaries of the mature termite queen *Odontotermes redemanni* (Wasmann) have been observed in course of an investigation on the development and functional morphology of the reproductive organs of the mound building species of termite.

The oocyte of the termite queen is enclosed within the follicular epithelium, and is nearly oval in outline. It gradually increases in length as it approaches the pedicel. The nucleolus of these cells takes up a deep stain, when subjected to Feulgan's reaction and shows remarkable changes at different stages. In the comparative younger oocytes, it remains intact, apparently as an unified body within the nucleus of the cells. But as the oocyte attains maturity, and increases in size, the nucleolus breaks up into many smaller particles, some of which remain clustered together, while the others remain practically scattered in the karyolymph

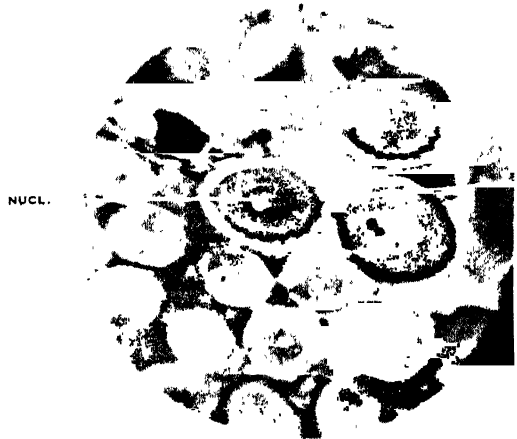

FIG. 1. L.S. Through the ovariole of the termite queen *Odontotermes redemanni* (Wasmann) in the region of germarium showing the Oocytes, Foll. Nucl. Nucleolus of the follicular epithelium. Nucl. Nucleolus of the Oocytes.

It becomes quite clear from the histological examinations of the serial sections, that these

bodies have arisen by fragmentation of the original nucleolus of the younger oocytes. The number of these particles vary from two to eight in different cells and does not bear any definite relationship to the size of the cells containing them.

Various interpretations have been given as to the physiological set-up of the cells, leading to such nuclear fragmentations. Gross<sup>1</sup> stated that such fragmentations mark the decline in the functional activities of the cells. But such a view could not be applied in the present case, where such fragmentations have also been noted in those oocytes, which are quite immature from functional point of view. On the other hand, Murray<sup>2</sup> who observed like phenomenon in *Gryllus*, states that such fragmentation is simply a method for increasing the secretory activities of the cells. In the present case, it has been observed that simultaneously with the fragmentations of the nucleolus, specially in the more mature cells, yolk droplets begins to be deposited in the cells (Ries<sup>3</sup>) and probably the increased secretory activities of the cells, resulting from the nucleolar fragmentations, have a vital role to play in the yolk deposition.

Studies have also been made on the cytochemical distribution of the alkaline phosphatase in the oocytes and the general plan of distribution is tabulated below:

TABLE I

Showing the distribution of the alkaline phosphatase in the mature oocytes of *Odontotermes redemanni* (Wasmann)

Follicular epithelium	..	+
Nucleolus	..	++
or		
Nucleolar fragment-	..	++
Yolk droplets	..	+++

+ = Positive reaction.

It is quite obvious from the above table that the distribution of the alkaline phosphatase shows remarkable variability in different parts of the mature oocyte. The phosphatase activity is maximum in yolk droplets and in older egg cells it shows intense positive reaction. The follicular epithelium shows a lesser phosphatase reaction, while the nucleolus and the nucleolar fragments come next to the yolk droplets as evident from the intensity of reaction. The uniform reactions in the nucleolus and the nucleolar fragments also shows the physiological interrelationship between the two and the origin of the latter from the former.

Zoological Labs.,  
Dept. of Biology,  
Scottish Church College,  
Calcutta-6, November 11, 1957.

BARUNDEB BANERJEE.

1. Gross, J., *Z. Wiss. Zool.*, 1911, **69**, 139-201.
2. Murray, M. R., *Biol. Bull.*, 1923 **50**, 21-34.
3. Ries E., *Z. Zellforsch. Mikr. Anat.*, 1932, **16**, 314-88.

### PELAGIC TUNICATES AS INDICATORS OF WATER MOVEMENTS OFF WALTAIR COAST

MARINE planktonic animals, owing to their limited powers of locomotion, have long been recognised as indicators of water movements. Their appearance and disappearance only in specified seasons is taken as a true reflection of the physico-chemical changes in the environment. Some pelagic tunicates on account of their high degree of sensitivity to small changes in temperature and salinity have previously been reported as indicators of different water-masses and currents by Aida (1907)<sup>1</sup>; Schmidt (1909)<sup>2</sup>; Bowman (1922)<sup>3</sup>; Essenberg (1926)<sup>4</sup>; Russel and Hastings (1933)<sup>5</sup>; Thompson and Frost (1935)<sup>6</sup>; Russel (1935, 1939)<sup>7,8</sup>; McKenzie (1939)<sup>9</sup>; Tokioka (1940)<sup>10</sup>; Thompson (1942, 1948)<sup>11,12</sup>; and Fraser (1954).<sup>13</sup>

An examination of the pelagic tunicates in plankton samples collected from a fixed station in the Lawson's Bay, Waltair, for the past 3 years, has shown that there are two qualitatively distinct populations of these animals in the two opposing currents prevailing off this coast.<sup>14-18</sup> A southerly current from July to December characterised by low salinity, high turbidity and high temperature and a northerly current from January to June characterised by high salinity, high transparency and low temperature.

The planktonic tunicates present during the southerly current period are *Fritillaria lucibila*, *F. formica*, *F. campila*, *Oikopleura cophocerca*, *Pegea confederata* (solitary and aggregate zooids), *Ritteriella amboinensis* (solitary and aggregate zooids), aggregate zooids of *Cyclosalpa pinnata* and *Salpa cylindrica*.

The tunicates present during the northerly current period are *Fritillaria borealis* f. *sargassi*, *F. pellucida*, *F. haplostoma*, *F. limpida*, *Althoffia pacifica* and *Oikopleura rufescens*. In the March-April period, there is upwelling in the nearshore waters and the mesopelagic species, *F. pellucida* makes its appearance in the surface waters during these months. There are a few forms like *Oikopleura longicauda*, *O. fusiformis*



and *O. dioica* which are present throughout the year in variable numbers, and it is presumed that these are hardy forms, able to tolerate wide ranges of salinity and temperature. Detailed investigations on the distribution of pelagic tunicates off the Indian coast and stolon formation in relation to the prevailing hydrographical conditions are in progress.

Dept. of Zoology, P. N. GANAPATI.  
Andhra University, P. V. BHAVANARAYANA.  
Waltair, November 22, 1957.

1. Aida, T., *Imp. Univ. Tokyo J. Coll.*, 1907, **23**, 1-25.
2. Schmidt, Johs, *Rap. et Proc. Verb. Cons. Perm. Int. Expl. Mer.*, 1909, **10**.
3. Bowman, A., *Brit. Assoc. Adv. Sci., 90th Meeting*, 1922, 367.
4. Eesenberg, C. E., *Univ. Calif. Publ. Zool.*, 1926, **28**, 399-521.
5. Russel, F. S., and Hastings, A. B., *J. Mar. Biol. Assoc. N.S.*, 1933, **18**, 635-40.
6. Thompson, H. and Frost, N., *Rep. Fish. Res. Lab. Newfoundland*, 1935, **2**, 25-29.
7. Russel, F. S., *J. Mar. Biol. Assoc. N.S.*, 1935, **20**, 309-92.
8. —, *J. du. conseil*, 1939, **14**, 171-92.
9. MacKenzie, R. A., *Proc. Nova. Scot. Inst. Sci.*, 1937, **20**, 13-30.
10. Tokioka, T., *Rec. Oceanogr. Works of Japan*, 1940, **11**, 1-26.
11. Thompson, H., *Comm. Sci. Ind. Res. (Aust.) Bull.*, 1942 **153**, 47.
12. —, *Commonwealth conseil for Scientific and Industrial Research, Australia, Melbourne*, 1948, 196.
13. Fraser, J. H., *J. Mar. Biol. Assoc. N.S.*, 1954, **33**, 345-46.
14. Ganapati, P. N., LaFond, E. C. and Bhavanarayana, P. V., *Proc. Ind. Acad. Sci.*, 1956, **44 B**, 68-72.
15. Bhavanarayana, P. V. and LaFond, E. C., *Ind. Jour. Fish.*, 1957, **4**, 75-79.
16. LaFond, E. C. and Bhavanarayana, P. V., *Ind. Jour. Met. Geophy.*, 1957, **8**, 209-12.
17. Ganapati, P. N. and Rama Sarma, D. V. (Communicated).
18. — and Subba Rao, L. V. (Communicated).

#### OCCURRENCE OF ARTEMIA SALINA IN SAMBHAR LAKE, RAJASTHAN

So far as known, *Artemia salina* has not been recorded from India previously but it is being reported for the first time by the author. The genus *Artemia* was previously reported by Kulkarni (1953) in the salt pans at Vadala in the outskirts of Bombay. It is a very variable species found in salt lakes throughout the old world. Gunther (1899) agreed with Packard that only two well-defined species of *Artemia* have been described, viz., the old world form *A. salina* with which *A. milhauseni* (or *Artemia* sp. gr. 1-2015) has been proved to be

identical by Schmankewitch (1875) and the new world *A. gracilis* including Verrill's other American species as synonymous. All the species of this genus, viz., *A. salina*, *A. milhauseni*, *A. fertilis*, *A. monica*, *A. utahensis*, *A. gracilis*, have been distinguished by characters which vary with the salinity of water in which they live. Schmankewitch (1875) transformed the brine shrimp *A. salina* to *A. milhauseni* and back by rearing it in different concentration of salt water. Thus it is clear that a complete revision of the group should be made and more minute details are taken into account in order to arrive at better and more stable specific differences which are not liable to be affected by the change of salinity.

*Artemia salina* is a permanent inhabitant of the lake. It lives in the lake from 4° Be (Baume) to 23° Be. It is subjected to the great fluctuation of salinity (36.4‰ to 194.3‰). Thus the range of tolerance to salinity is very wide. After the maximum limit of tolerance this species dies in summer as the brine approaches saturation and due to the increase in sodium carbonate and bicarbonate. The range of concentration of sodium carbonate is from 18.3 mg./L. to 39.4 mg./L. and of bicarbonate is from 4.8 mg./L. to 12.3 mg./L. These compounds are very rich in the brine after 23° Be. The death of *Artemia salina* was formerly looked upon by the salt-makers as an indication that salt would begin to form soon. The hydrogen-ion concentration of the brine varies from 7.8 to 9.8. It tolerates the pH upto 9.6. The little brine shrimps are uniformly distributed throughout the lake but clouds and streaks of *Artemia* are generally found near the shore. In such streaks the amount of *Artemia* is found more than normal. The great density of their aggregation seems to be the result of local currents. Their distribution in the lake is determined by four factors.

1. Salinity of the brine.
2. Amount of carbonates and bicarbonates in the brine.
3. Amount of oxygen in the brine.
4. Amount of carbon dioxide in the brine.

The colour of the male is pale-greenish while that of the female is more reddish. The females are longer than the males. The males are less frequently met with than the females. Their food supply is provided principally by the blue green algæ — *Dunaliella salina* Teodoresco, *Aphanotheca spiraphytica* Frey, *Anabena* Sp. and *Anthrospira* Sp. and diatoms which are common in the lake. This crustacean spends its entire life-cycle in the water growing to sexual maturity

in about 1 month. Before dying, they deposit immense layers of eggs in some places over an inch in thickness. The eggs are hard-shelled, often floating on the surface in long interlacing streaks of a brown colour. The egg hatches in the late spring and the embryo develops into a free-swimming nauplius which passes through a series of stages before reaching maturity. The detailed description of its ecology and development will follow soon.

My best thanks are due to Dr. J. P. Harding, British Museum, London, for identification of species, as well as to Dr. D. K. Mathur for his help and guidance.

Dept. of Zoology, INDERCHAND BAID.  
Jaswant College,  
Jodhpur, August 21, 1957.

1. Kulkarni, C. V., *Jour. Bombay Nat. Hist. Soc.*, 1953, 51, 951.
2. Gajewski, N., *Int. Rev. d. Ges. Hydrobiol. u Hydrogr.*, 1922, 10, 139.
3. Gunther, R. T., *Jour. Linn. Soc. Zool. London*, 1899, 27, 345.
4. Jensen, A. C., *Biol. Bull.*, 1918, 24, 18.
5. Kellgg, V. L., *Science*, 1906, 24, 594.
6. Schmankewitsch, W. I., *Ztschr. Wiss. Zool.*, 1875, 25, Supplement. (Abstract, *Nature*, 1879, 29).

### THE OCCURRENCE AND INHERITANCE OF TELESCOPIC LEAF-SHEATHS IN SORGHUM

In Sorghum, normally the leaf-sheath enwraps the internode to two-thirds of its length. Rangaswamy Ayyangar *et al.* (1938), described in detail the morphology of internodes and leaf-sheaths. However, in the case of "Bonganhilo" (A. S. 4033-Sorghum caudatum, Stapf.), a variety from S. Africa, a different type of leaf-sheath is met with. The leaf-sheaths are two to three times longer than the internode and enwraps two to three internodes above the base. The successive leaf-sheaths on the plant telescope into each other giving it a characteristic appearance. Conner and Karper (1917) observed that leaf-sheath is not susceptible for changes in the environment. It is a varietal character. In a study of the crosses between a normal leaf-sheathed variety (*Punasa jonna*-G.3, *Sorghum durra*, Stapf.) and telescopic leaf-sheathed variety, the inheritance of the telescopic leaf-sheath was observed.

The average internodal and leaf-sheath lengths of the above two parents are given in Table I.

It is seen from Table I that in both the parents, the lengths of internodes and leaf-sheaths follow unimodal disposition. It is inter-

esting to note that the differences in internode and leaf-sheath length in the case of telescopic sheath variety are on the positive side, while in that of normal-sheathed variety it is negative indicating distinctly the differences in this character.

TABLE I

Internode number	Normal leaf-sheath variety (G. 3. <i>Jonna</i> )			Telescopic leaf-sheath variety (Bonganhilo-A.S.4003)		
	Average length in cm.		Differ- ence (-)	Average length in cm.		Differ- ence (+)
	Internode	Leaf- sheath		Internode	Leaf- sheath	
1	11.2	15.3	..	2.0	10.6	14.6
2	18.1	17.9	0.2	4.8	18.5	13.7
3	22.1	19.0	3.1	7.4	21.7	14.3
4	25.6	18.8	6.8	8.6	24.5	15.9
5	27.7	18.1	9.6	11.1	25.2	14.1
6	27.1	17.1	10.0	11.9	25.7	13.8
7	25.6	16.6	9.0	12.8	26.6	13.8
8	24.3	16.0	8.3	11.9	26.5	14.6
9	24.4	15.0	9.4	10.9	27.1	14.2
10	23.6	15.1	8.5	10.3	24.2	13.9
11	23.9	16.6	7.3	8.7	22.2	13.5
12	23.2	17.3	5.9	8.0	19.6	11.6
13	22.6	17.0	5.6	5.7	19.3	13.6
14	22.0	17.0	5.0	4.0	18.7	14.7

In the F<sub>1</sub> generation it was seen that the leaf-sheaths were telescopic in nature indicating dominance of this character over the normal leaf-sheath. In the F<sub>2</sub> generation, the following segregation was observed (Table II).

TABLE II

Selection No.	Telescopic leaf-sheath	Normal leaf-sheath
X-I-1/1	.. 56	17
X-I-2/1	.. 65	21
Total	.. 121	38
Expected on 3:1 ratio:	119.2	39.8
X <sup>2</sup> =0.116	P between 0.95 and 0.5)	

From the above table it is seen that the telescopic leaf-sheath is a simple dominant to the normal leaf-sheath indicating that this factor is governed by a single pair of genes. The gene responsible for telescopic leaf-sheaths may be designated *Ls* and the recessive gene producing normal leaf-sheath *ls*.

Further work with other varieties is in progress.

I am grateful to Sri. B. Suryanarayana Murthy and B. L. Narasimha Murthy for their valuable

suggestions in preparing this note and encouraging me to take up this work.

Agricultural Res. Station, C. SREERAMULU.  
Lam Farm, P.O. Guntur,  
November 22, 1957.

1. Conner, A. B. and Karper, R. E., *Science*, 1917, 45, 144-45.
2. Rangaswamy Ayyangar, G. N., et al., *Proc. Ind. Acad. Sci.*, 1938, 7 (4), 161-76.
3. —, *Ind. Jour. Agric. Sci.*, 1942, 12 (4), 527-63.

### CYTOLOGY OF ISOETES

THREE species of *Isøetes* are reported from South India, namely, *I. coromandelina* L., *I. Sampathkumarani* Rao and *I. Sahyadri* Mahabale. Of these, the cytology of *I. coromandelina* and *I. Sampathkumarani* has been critically investigated and this note deals with the important cytological facts observed in this study.

*I. coromandelina* L.—This species was collected from Kovalam, Veli, Quilon and Cranganore in Kerala State and from Waltair in Andhra Pradesh. All the above collections were found to be diploids with 22 chromosomes and a fragment (or B chromosome?) in root-tip cells (Fig. 1). The chromosomes nearly all show median or submedian constrictions and vary from 2-4  $\mu$  in length. All the plants examined from each of the above collections were megasporangiate. A few microsporangiate plants were obtained from Chakkai in Trivandrum City.

Meiosis in megaspore mother-cells of the diploid shows complete or partial asynapsis followed by one or two equational divisions of chromosomes resulting in the formation of dyads or tetrads. Certain spore mother-cells clearly show 22 univalents and a fragment (Fig. 4), while in others chromosome associations in the form of rings, chains or cross-

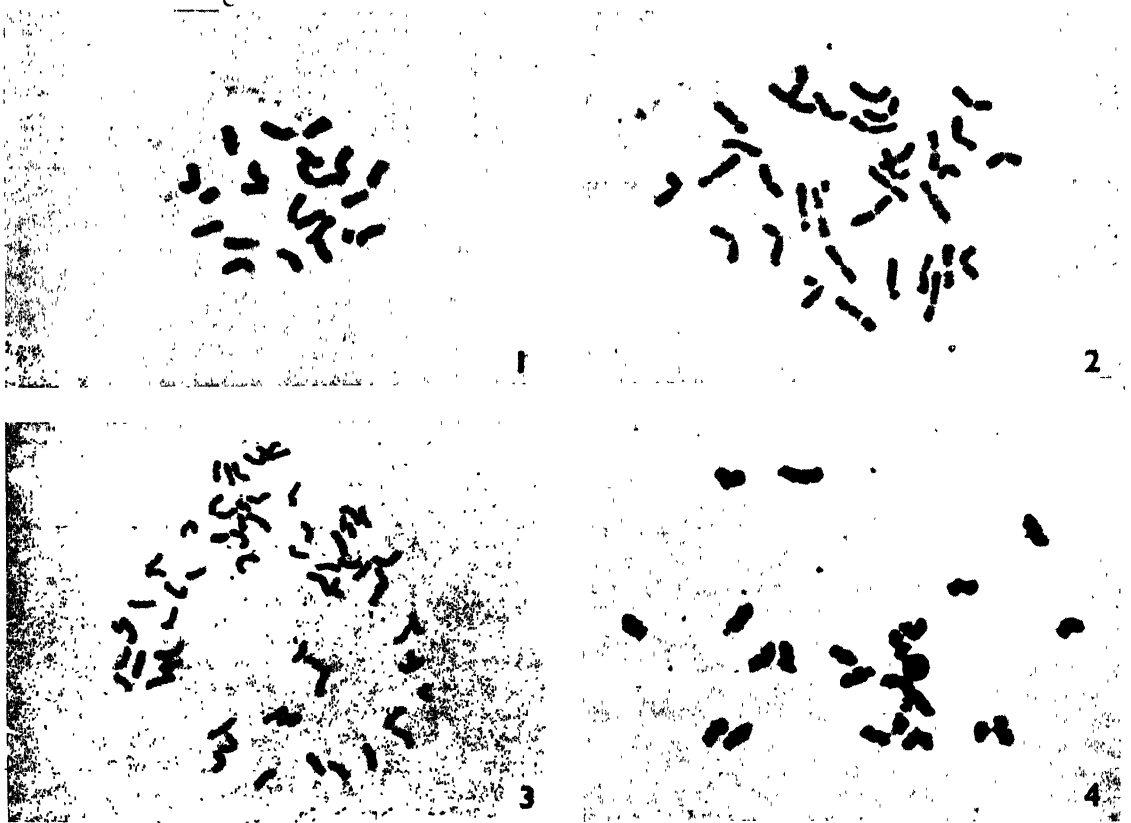

FIG. 1. A root tip squash preparation of the diploid *Isøetes coromandelina* L.  $2n = 22 + 1$  ( $\times 1,000$ ).

FIG. 2. Somatic mitosis in a root-tip cell of the triploid *I. coromandelina* L. showing 33 chromosomes and a fragment ( $\times 1,000$ ).

FIG. 3. A root-tip cell of *I. Sampathkumarani* Rao showing 66 chromosomes ( $\times 1,000$ ).

FIG. 4. A megaspore mother cell of the diploid *I. coromandelina* L. showing 22 chromosomes and a fragment ( $\times 1,000$ ).

shapes involving usually four chromosomes have been observed. This is clearly suggestive of structural hybridity (translocations). Microspore mother-cells of the diploid show complete asynapsis followed by irregular chromosome distribution resulting in the formation of varying numbers of micronuclei. Usually dyads or tetrads are organised. Polyspory has also been observed in rare cases. Variation in size of the spores and nuclear contents is very remarkable. Almost all the microspores are non-viable.

One of the plants of *I. coromandelina* collected from Kovalam, near Trivandrum, and grown in the garden was seen to be a triploid with 33 chromosomes and a fragment in root-tip cells (Fig. 2). The chromosomes of the triploid mostly show median or submedian constrictions and vary from 3.3-6 $\mu$  in length. Meiosis in megaspore mother-cells of the triploid mostly results in the formation of unreduced megaspores, while in others there is irregular chromosome distribution.

*I. Sampathkumarani* Rao.—This species was collected from Bangalore and Waltair. Root-tip cells showed 66 chromosomes (Fig. 3). Most of the chromosomes show median or submedian constrictions and vary from 2-4 $\mu$  in length.

The results of this study taken together with previous reports of chromosome numbers in this genus, like  $n=11$  in *I. echinospora*<sup>2</sup> and *I. asiatica*,<sup>6</sup>  $n=22$  and  $n=33$  in *I. japonica*<sup>6,7</sup> and  $n=54-56$  (probably 55) in *I. lacustris*<sup>4</sup> suggest that there is a polyploid series in this genus based on the haploid number  $n=11$ , which it shares in common with other ancient genera like *Lycopodium* (part)<sup>1,4</sup> and *Osmunda*.<sup>3,5</sup> That aneuploidy (apart from polyploidy), has also been at work in speciation in this genus may be observed from the existence of  $n=10$  in *I. hystrix*<sup>3</sup> (probably derived from  $n=11$ ).

The cytological facts presented above for *I. coromandelina* show that this is an asynaptic apogamous form. Asynapsis in megaspore mother-cells followed by equational chromosome division results in the production of unreduced spores. In the case of the diploids, the microspores are mostly non-viable and this necessitates an apogamous type of reproduction to perpetuate the species, since no accessory method of propagation is known in this species. Asynapsis in megaspore mother-cells helps to preserve the genome of the parent unchanged. Asynapsis is probably the result of

accumulation of structural hybridity rather than the consequence of hybridization.

Dept. of Botany,  
University College,  
Trivandrum, November 20, 1957.

A. ABRAHAM.  
C. A. NINAN.

1. Delay, C., *Rev. De Cyt. et De Biol. Veg.*, 1953, **4**, 59.
2. Ekstrand, H., *Svensk. Bot. Tidsk. Bd.*, 1920, **14**, 312.
3. Monton, I., *Problems of Cytology and Evolution in the Pteridophyta*, Cambridge University Press, 1950.
4. Mehra, P. N. and Verma, S. C., *Curr. Sci.*, 1957 **26**, 55.
5. Ninan, C. A., *J. Indian bot. Soc.*, 1956, **35**, 248.
6. Takamine, N., *Bot. Mag. Tokyo*, 1921, **35**, 184.
7. Yuasa, Y., *Ibid.*, 1934, **49**, 27.

#### EFFECT OF MOWING GRASS ON THE CONCENTRATIONS OF CERTAIN CONSTITUENTS OF THE AIR SPORA

The gravity slide and the Petri dish exposure methods used by earlier plant pathologists and allergists for the study of changes in the air-borne spore flora or 'air spora' are shown<sup>1</sup> to be of very low efficiency and the short period changes in the concentration of the spore load at any locality could not be studied until the development of a more efficient suction air sampling equipment like the Hirst's "Automatic Volumetric Spore Trap".<sup>2</sup> Spores present in a limited volume of air sucked into this trap are caught on the sticky surface of a slowly moving slide (which gives a continuous trace), a microscopic examination of which makes it possible to determine the time of deposition of any spore type on the trace. The results obtained with a Hirst spore trap showing how, certain common agricultural practices like mowing of the grass in a field pollute the air with plant pathogens and with respiratory allergens for a short period, are described in this note.

In studies, concerned primarily with the aerial dissemination of the loose smut of barley, air was sampled at a suction rate of 10 litres per minute at a height of 35" above the ground level using a "Casella" model of the Hirst trap located in the centre of a smut-infected barley field at the Imperial College Field Station in Sunninghill, Berks., England. The changes observed in the concentrations of *Cladosporium*, *Epicoccum*, *Alternaria* and Pollens together with the changes in weather conditions during July 19-24, 1955, plotted at hourly intervals are shown in Fig. 1 to illustrate how mowing of the grass and other weeds around the smut-

infected barley field in the afternoon of July 20 brought about noticeable quantitative changes in the air spora of the area. The changes in the concentrations of the four spore types affected by the mowing operation together with the concentration of smut spores observed over a period of 12 hours, taken at hourly intervals immediately before, during and after the operation of the mowing machine are given in Table I.

TABLE I

Concentrations of the five spore types before, during and after mowing grass and other weeds around a smut-infected barley field

Time G. M. I. Hrs.	Estimated number of spores per cubic meter of air							
	* <i>Cladosporium</i>		<i>Epicoccum</i>	<i>Alternaria</i>	Pollens	* <i>Ustilago</i>		
	Clumps	Spores				Clumps	Spores	
10-00	23800	60600	6450	450	300	750	900	
11-00	27000	91400	7050	0	600	450	450	
12-00	25800	105000	6900	450	750	1950	5400	
13-00	12300	21750	2400	0	600	1200	2850	
14-00	†	432600	27750	1800	600	1200	1950	
15-00	25050	94650	30300	1050	300	300	300	
16-00	15300	41700	10500	450	600	900	1950	
17-00	15600	30150	1800	150	300	900	1350	
18-00	18000	46500	1500	0	1200	750	1650	
19-00	24000	43800	1200	0	5850	1050	1050	
20-00	21000	51000	3600	750	1200	300	600	
21-00	21000	43000	1500	600	900	900	2250	

\* Clumping of a variable number of spores to form a single 'dispersion unit' is common in *Cladosporium* and *Ustilago* and so number of the 'dispersion units' (Clumps) in the air at each hour are also given.

† Spores deposited as a thick band; counts for individual clumps not taken.

The changes observed on July 19 are typical of the dry weather with the maximum concentrations occurring at about noon. July 20 is a normal dry day and the concentrations recorded in the forenoon (before starting the mowing operation) showed a gradual increase in their numbers characteristic of their usual periodicities exhibited on such dry days. The reason why counts taken at 13.00 hours were low is not known. After lunch time the mowing machine was operated continuously for over a period of about 2 hr. to mow the grass and other weeds growing outside the barley field and the entries in Table I show that concentrations of *Cladosporium*, *Epicoccum* and *Alternaria* have shown an increase of about 5, 4 and 4 times their respective usual concentrations on similar days during these hours. By contrast during and immediately after the mowing process the

concentration of pollen grains showed a slight fall, but an increase in their numbers (about 9 times) was noticed after a lag of about 2 hours. The reason for this apparent lack of correlation in time between mowing and catch of pollens in the trap is unknown.

The concentrations recorded on the subsequent days (Fig. 1) show that *Cladosporium* and *Epicoccum* occurred in their usual numbers on the next day itself while the pollens and *Alternaria* took about 2 days to recover.

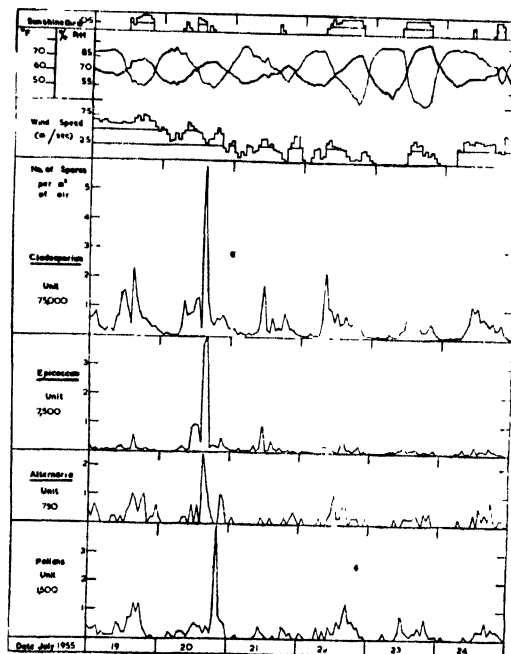

FIG. 1. Changes in the concentrations of the four spore types with changes in the weather conditions.

During the afternoon of July 20, when mowing operation was carried out, no major changes were observed either in the weather conditions (Fig. 1) or in the concentration of spores of *Ustilago* (which came from the smut-infected barley crop not affected by the mowing operation, Table I). Therefore the sharp rise in the concentrations of the four spore types described above may be due to liberation of these spores from grasses and other weeds growing in the locality that are affected by the working of the mowing machine.

The use of the improved suction air sampling method has revealed this interesting short period change in the air spora and it is likely that our knowledge of the composition of the spore content of the atmosphere will increase considerably if these methods are used widely.

I wish to express my indebtedness to Prof. P. H. Gregory for his guidance, help and encouragement.

Dept. of Botany, T. SREERAMULU.\*  
Imperial College of Science  
and Technology,  
London, S.W.-7, November 22, 1957.

\* Present address: Aerobiology Laboratory, Department of Botany, Andhra University, Waltair, India.

1. Gregory, P. H. and Stedman, O. J., *Ann. appl. Biol.*, 1953, **40**, 651.
2. Hirst, J. M., *Ibid.*, 1952, **39**, 257.

### X-RAY INDUCED SOMATIC HAPLOIDY IN WATERMELON

DRY seeds of watermelon (*Citrullus vulgaris* Schrad. var. *Asahi Yamato*) were irradiated with 24,000, 36,000 and 48,000 r of X-rays with a view to study the effects of the radiation on sex expression in the treated plants and their progenies. During a study of microsporogenesis

in plants raised from the irradiated seeds, it was found that a whole branch in a plant belonging to the 48,000 r treatment had only the haploid number of chromosomes ( $2n=11$  as against the normal  $2n=22$  found in the other branches). The leaves and flowers on this branch were smaller and the stem and petioles were thinner. Chromosome configurations at metaphase I of meiosis in 14 cells were found to be: all univalents in 7 cells (Fig. 1), 9 univalents and 1 bivalent in 5 cells and 7 univalents and 2 bivalents in 2 cells. Among the bivalents observed, three had chiasmata in both arms of the chromosomes and the rest were of the rod type with a terminal chiasma in one of the arms. Only about 12% of pollen took stain in acetocarmine; the well-stained pollen were also larger in size and had an average diameter of 85.4 microns. The unstained pollen grains were small (about 40 to 45 microns in diameter) and were often irregular in shape (Figs. 3 and 4). The large, well-stained pollen obviously represent dyads, since they have the same size as the pollen of diploid water-

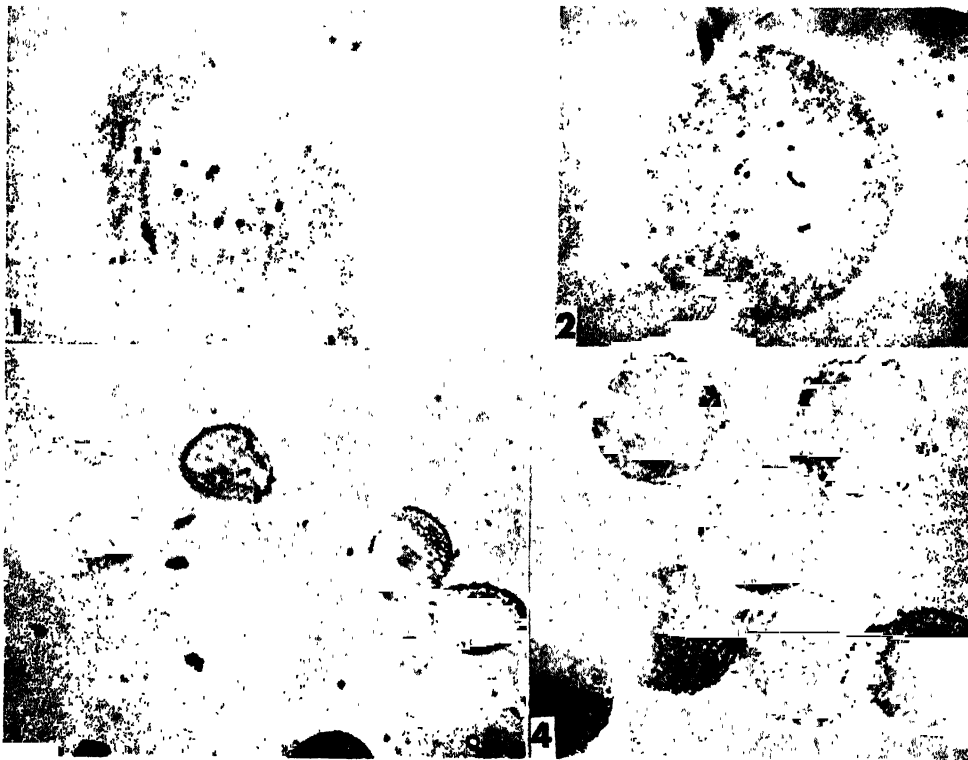

FIGS. 1-2. Metaphase I of meiosis in the haploid showing 11 univalents. In Fig. 1, two univalents are secondarily associated and in Fig. 2, there is one group of three chromosomes, two groups of two chromosomes and four single chromosomes.

FIG. 3. Pollen from the haploid. Most are shriveled but occasionally a large well-stained grain is seen.

FIG. 4. Pollen from a normal watermelon plant.

melon. A solitary pistillate flower was formed in the haploid branch but no fruit setting could be obtained though the flower was hand-pollinated with normal pollen.

The haploid branch probably owes its origin to some process of reductional mitosis which should have taken place in cells of the shoot meristem prior to the initiation of branching. Menzel<sup>1</sup> reported the occurrence of spontaneous somatic reduction of chromosome numbers in some polygenomic hybrids in *Gossypium*. Using pollen size and fertility as indices, we examined every branch of a large number of control watermelon plants for possible occurrence of spontaneous haploidy but no haploid could be detected. It is therefore very probable that the somatic reduction in chromosome number has been caused by the X-ray treatment. This inference is further supported by the observation made in this laboratory that haploid cells occur occasionally in root meristems of barley and *Triticum monococcum* following exposure of seeds to X-rays. While irradiation of pollen and inflorescences had been used for many years as a method of obtaining haploids in several plant species,<sup>2</sup> there seems to be no record so far of the occurrence of wholly haploid sectors in plants raised from seeds subjected to any type of radiation.

An interesting feature of meiosis in some microsporocytes of the haploid was a strong tendency for secondary pairing among the univalent chromosomes. The maximum secondary association occurred in a cell which had seven groups comprising one group of 3 chromosomes, two groups of 2 chromosomes each and four single chromosomes (Fig. 2). Thus, while the evidence from primary pairing suggests segmental duplications in 4 chromosomes of the haploid set thereby rendering 9 as a probable basic chromosome number for this species, the secondary association data suggest a basic number of 7. Opinions, however, vary regarding the real significance of secondary association of chromosomes. Also, the conclusions that could be drawn from the present data suffer from the limitations that first, it is difficult to be sure that the 11 chromosomes found represent a complete haploid set instead of a random assortment of 11 chromosomes of the diploid complement, including a few homologous pairs and secondly, prior to somatic reduction, segmental interchanges and duplications could have taken place among some chromosomes, thereby leading to the observed primary and secondary pairing. No abnormalities were found with regard to morphological or growth characteristics in the branch with 11 chromosomes and this

would suggest that a complete haploid complement is present. Since regular bivalent formation and anaphase separation were observed during meiosis in the other branches of this plant, the possibility of occurrence of gross structural changes in chromosomes could also be ruled out. No haploid has so far been reported in watermelon and hence it is not possible to draw inferences by comparison with previous data. However, it is of interest that the lowest haploid chromosome number recorded in Cucurbitaceae is 7, which occurs in the genus *Cucumis*,<sup>3</sup> and it could well be that the genus *Citrullus* is derived from a basic number 7 by a process of chromosome fragmentation and segmental duplication, analogous to the mechanism of speciation already postulated by Bhaduri and Bose<sup>4</sup> for several cucurbits.

We are indebted to Dr. B. P. Pal and Dr. S. M. Sikka for their interest and encouragement.  
Division of Botany, M. S. SWAMINATHAN,  
Indian Agric. Res. Inst., M. P. SINGH.  
September 17, 1957. .

1. Menzel, M. Y., *Amer. J. Bot.*, 1952, **39**, 625.
2. Maheswari, P., *An Introduction to the Embryology of Angiosperms*, McGraw-Hill Book Company, 1950, 453.
3. Darlington, C. D. and Wylie, A. P., *Chromosome Atlas of Flowering Plants*, George Allen and Unwin Ltd., 1955, 519.
4. Bhaduri, P. N. and Bose, P. C., *J. Genetics*, 1947, **47**, 237.

#### EFFECTS OF MALEIC HYDRAZIDE ON AN EARLY VARIETY OF RICE

THE recent discovery of Maleic Hydrazide has led many workers in the field of plant physiology to study the role of this chemical on various plants.<sup>1 b</sup> The present investigation has been designed to study the effect of Maleic Hydrazide on the growth and reproduction of an early variety of rice.

Grains of the variety N. 136 were obtained from the Central Rice Research Institute, Cuttack. After a preliminary selection for uniformity, the seeds were soaked with 10,000, 1,000, 100 and 10 p.p.m. of MH-40 for 48 hr. on December 30, 1956. The pre-soaked seeds were washed thoroughly in water and were sown in earthenware pots containing a mixture of soil and cowdung manure in the proportion of 8 : 1. The plants were next subjected to weekly foliar spray with the corresponding solutions in which they were previously soaked. As the spraying produced detrimental effects it was discontinued after the second spray.

All the plants treated with 10,000 p.p.m. died after the fifth week from sowing, i.e., after the first foliar spray and majority of the plants treated with 1,000 p.p.m. died after 6 weeks, i.e., after the second foliar spray and hence no data could be collected on yield and its components from these two series. The few plants which survived the 1,000 p.p.m. treatment flowered later than the controls. The plants treated with 100 and 10 p.p.m. did not show any clear variation from the control plants in the time of ear emergence (Table I).

TABLE I

Days from sowing to ear emergence and vegetative growth characters at the final stage

Treatments	No. of days to ear emergence	No. of tillers per plant	Total No. of green leaves per plant	No. of leaves on the main shoot	Height per plant in cm.
MII 1,000 p.p.m.*	83.50	13.67	49.00	17.00	57.92
100 p.p.m. ..	75.46	6.13	23.17	10.13	62.92
10 p.p.m. ..	75.17	9.17	33.75	13.00	67.17
Controls	75.75	7.55	28.85	11.55	62.88

\* Each figure is an average of 6 plants in case of 1,000 p.p.m. concentration. In all other treatments each figure is an average of 24 plants.

Higher concentration of 1,000 p.p.m. produced very adverse effects on most of the plants, but the plants which survived this treatment showed a conspicuous growth at later stages. The plants treated with the low concentration of 10 p.p.m. invariably showed better vegetative growth in all respects than the controls. Plants treated with 100 p.p.m. did not show any appreciable change in vegetative growth than those of the control plants.

An increased grain yield (Table II) was observed in the plants treated with the

TABLE II

Grain yield and its components  
(Average of 24 plants)

Treatments	Grain yield per plant in g.	No. of panicles per plant	Length of panicles in cm.	No. of spikelets per panicle	No. of grains per panicle	Percentage of grain setting	1,000 grain weight in gm.
MII 100 p.p.m.	2.86	4.68	17.35	77.18	44.54	57.65	14.14
10 p.p.m.	3.43	5.71	18.43	84.10	42.28	50.61	14.09
Controls	2.76	5.20	17.84	81.89	40.20	48.87	14.16

M.H. solutions, highest being observed with the lower concentration of 10 p.p.m. The higher grain yield observed was due to a promotive effect of the chemical on the factors such as number of panicles, length of panicle and number of spikelets formed per panicle.

Our thanks are due to Messrs. Naugatuck Chemical International, New York, for kindly supplying their preparation MH-40, to the Utkal University, for the award of the Government of India Senior Research Scholarship to one of us (G. S.) and a grant-in-aid from the Jnan Vijnan Parisad Fund, and to Prof. B. Samantarai, for providing facilities in the Department of Botany, Ravenshaw College, Cuttack, for carrying on this investigation.

Dept. of Botany,  
Ravenshaw College,  
Cuttack-3, September 26, 1957.

G. MISRA.  
G. SAHU.

1. Choudhri, R. S. and Bhatnagar, V. B., *Phyton*, 1955, **5**, 19.
2. Compton, W., *Bull. Torrey Bot. Club*, 1952, **79**, 205.
3. Crafts, A. S., Currier, H. B. and Day, B. E., *Hilgardia*, 1950, **20**, 57.
4. Currier, H. B., Day, B. E. and Crafts, A. S., *Bot. Gaz.*, 1950, **112**, 272.
5. Greulach, V. A. and Atchison, E., *Bull. Torrey Bot. Club*, 1950, **77**, 2.2.
6. Klein, W. H. and Leopold, A. C., *Plant Physiol.*, 1953, **28**, 293.
7. Naylor, A. W. and Davis, E. A., *Bot. Gaz.*, 1950, **112**, 112.
8. Nickell, L. G., *Amer. Jour. Bot.*, 1953, **40**, 1.

### STOMATAL TYPES IN CENTROSPERMAE

THE stomata of the leaves of Angiosperms have been classified into several types on the basis of their position in relation to the subsidiary or neighbouring cells. These types are named after the families in which they are best exemplified or in which they have been first recognized. Data obtained in recent years, however, show that the types are present in many other families, besides those after which they were originally named (Metcalfe and Chalk<sup>1</sup>). In dicotyledonous plants, four main types of stomata are generally recognized. These are:

A. *Ranunculaceae*.—The stomata are surrounded by a limited number of cells that are indistinguishable in size and shape from those of the other epidermal cells.

B. *Cruciferous*.—Stomata are surrounded by three cells, one of which is distinctly smaller than the other two.

C. *Rubiaceous*.—Stomata are accompanied on either side by one or many subsidiary cells parallel to the long axis of the guard cells.



D. *Caryophyllaceae*.—Stomata are surrounded by a pair of subsidiary cells at right angles to the long axis of the guard cells.

The present study of 22 plants belonging to 7 families of the order Centrospermae has revealed that the distribution and the type of stomatal apparatus on the leaf-surface show variations.

Typical Ranunculaceous type of stoma has been observed on both the leaf surfaces in *Chenopodium album* L., *C. ambrosioides* L., *Spinacia oleracea* L., *Amaranthus viridis* L., *A. gangeticus* L., *Celosia cristata* L., *Aerua lanata* Juss., *A. scandens* Wall., *Deeringia celosioides* R.Br., *Digera arvensis* Forsk., *Bougainvillea glabra* Choisy., and *Bærrhaavia diffusa* L. (Figs. 1 a and b). Along with this,

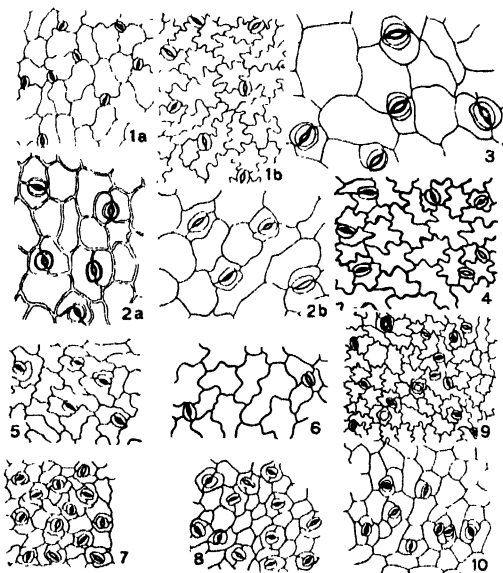

FIGS 1-10. Leaf epidermis showing stomatal types. L. E. = Lower Epidermis; U. E. = Upper Epidermis. Fig. 1 (a). *Amaranthus viridis* L., U. E.; Fig. 1 (b). *Aerua scandens* Wall., L. E. Fig. 2 (a). *Sesuvium portulacastrum* L., L. E.; Fig. 2 (b). *Trianthema monogynum* L., L. E. Fig. 3. *Portulacca oleracea* L., L. E. Fig. 4. *Rivinia humilis* L., L. E. Figs. 5 & 6. *Pupalia artopurpuria* Moq., L. E. & U. E. Figs. 7 & 8. *Alternanthera sessilis* R. Br., L. E. & U. E. Figs. 9 & 10. *Achyranthes aspera*, L., L. E. & U. E. (Mag.  $\times 45$ , Fig. 3. =  $\times 60$ ).

presence of Rubiaceous type of stoma has been reported<sup>1</sup> in the genera *Suaeda*, *Salsola* and *Salicornia* of the family *Chenopodiaceae*.

Rubiaceous type of stoma with two subsidiary cells has been found in *Sesuvium portulacastrum* L., *Trianthema monogynum* L., and *Basella rubra* L. (Figs. 2 a and b), and with four subsidiary cells in the genus *Calandrinia*<sup>1</sup> of *Portulacaceae*. Present observation on

*Portulacca oleracea* L., reveals the presence of 1 to 3 subsidiary cells in Rubiaceous type of stoma. The subsidiary cells are unequal in size, the inner one being smallest and outer one largest (Fig. 3).

In the family *Caryophyllaceae* the stomata are *Caryophyllaceous*, though variations have been recorded in several genera<sup>1</sup> belonging to the *Illecibraceae* of Benthum and Hooker. In the family *Phytolaccaceae*, the *Ranunculaceous* type of stoma has been reported<sup>1</sup> in *Phytolacca* and Rubiaceous type of stoma in *Petiveria* and *Rivinia*. In the course of present investigation it has been found that in *R. humilis* L., both *Ranunculaceous* and Rubiaceous types of stomata are present at random on the lower epidermis (Fig. 4), whereas on the upper epidermis stomata are absent.

Besides these, the following variations in stomatal types have been noted in the *Amaranthaceae*:

(a) In *Pupalia artopurpuria* Moq., the *Ranunculaceous* type of stoma is predominant on the epidermis. Sometimes, however, the surrounding cells are distinguishable from the wavy epidermal cells by their comparatively straight walls and they resemble the *Cruciferous* type by the presence of a small cell in a set of three surrounding cells (Figs. 5 and 6).

(b) The *Caryophyllaceous* type of stoma is predominant in *Alternanthera sessilis* R.Br. Together with this Rubiaceous stoma with two subsidiary cells are also found on both the epidermis (Figs. 7 and 8).

(c) In *Achyranthes aspera* L., stomata on the lower epidermis are typically *Ranunculaceous*, the surrounding cells being indistinguishable from the epidermal cells with regard to their size and form. In some cases, one of the surrounding cells is found to be much smaller than the other on the same surface with *Ranunculaceous* stomata (Fig. 9). On the upper epidermis, the Rubiaceous type is predominant though the *Cruciferous* type is also present together with pairs of stomata with 3 to 4 subsidiary cells surrounding them (Fig. 10).

The above account clearly reveals that stomata of more than one type occur together on the same leaf-surface in several genera of the families *Chenopodiaceae*, *Amaranthaceae* and *Phytolaccaceae*. Different types of stomata are found on the two surfaces of the leaf (e.g., in *Achyranthes aspera*) or intermediate types tending to connect two different types by slight modification of size and form of the surrounding cells on the same leaf-surface (e.g., in *Pupalia artopurpuria* and *Achyranthes aspera*).

Similar modifications have also been recorded in various other families.<sup>1,2</sup> As it is customary to study the stomatal apparatus from mature leaves we are usually analyzing the resultant structure of a stoma, the origin of which may be same, but which due to mutual pressure of adjacent epidermal cells during growth in surface of the leaf may have given rise to various modifications resulting in transitional forms. In such a case the type of stoma cannot be used as a diagnostic character of taxonomic value.

To avoid any taxonomic or ontogenic implication indicated by the name of the different types of stomata, Metcalfe and Chalk have suggested alternative names, e.g. Anomocytic (Ranunculaceous), Anisocytic (Cruciferous), Paracytic (Rubiaceous) and Diacytic (Caryophyllaceous). These terms may include broad variations of the respective types, but the various modifications that have been observed in Amaranthaceæ and other families cannot be classified on this basis. As the classification of stomata is based on the nature and orientation of the surrounding cells (which are easily influenced by growth adjustments) in relation to the guard cells, it seems more plausible to base it on the mode of development of the stomatal apparatus, instead of its final appearance at mature stage.

This note is a preliminary report on the stomatal types that has been observed in course of the study of developmental anatomy of the several members of the order Centrospermae.

In conclusion I desire to express my sincerest gratitude to Dr. I. Banerji, Head of the Department of Botany, Calcutta University, under whose guidance and care this work has been carried out.

Dept. of Botany,  
Calcutta University,

SUBIR SEN.

Calcutta, October 21, 1957.

1. Metcalfe, C. R. and Chalk, L., *Anatomy of the Dicotyledons*, Oxford Univ. Press, London, 1950, 1-2.
2. Sawyer, W. H., "Stomatal apparatus of the cultivated Cranberry, *Vaccinium macrocarpon*," *Amer. Jour. Bot.*, 1932, 19, 508-13.

#### TIP-ROT OF MESTA (*HIBISCUS CANNABINUS* LINN.)

With the increasing importance of *Hibiscus cannabinus* Linn. as a bast fibre crop of India, wider collection of indigenous and exotic types of the species was made for breeding purpose during 1953-55 by the Jute Agricultural Research Institute and the type materials were

tried in test plots under conditions prevalent in Nilganj, West Bengal. The test plot crops suffered from a serious epidemic disease hitherto unreported. The disease is somewhat similar in nature to 'brown-rot' described by Ghosh and George (1953). This new disease is designated 'tip-rot'. As cultivation of Mesta is spreading in the southern and the eastern States of India, it is worthwhile to note the symptoms and nature of the disease. The crop is usually sown in the middle of April and is harvested in September. The disease starts in July and continues throughout the months of July and August.

*Symptoms.*—Firstly tip of stipules of young leaf or leaf-buds turns brown; gradually the entire stipule turns brownish-black and wither away. Meanwhile dark brown or black lesion starts on the stem at the base of the petiole; consequently the young leaf turns ash-grey and looks somewhat scalded before it completely dries up and drops off. All the young leaves or leaf-buds may or may not be infected but as the tip of the stem turns brown and begins to dry up, all of them wither and drop off. As the fungus spreads in the tissue of the stem-tip, the latter shrivels and may



PLATE I

Young Mesta plants attacked with 'Tip-rot'.  
wither away. Innumerable pycnidia appear on the infected region sometimes with distinctly

superficial black perithecia scattered amongst the former. The loss of the growing tip soon arrests the apical growth; the plant either is killed or may develop axillary branches if favourable conditions prevail.

The symptoms of the disease are discernible in later half of July, particularly in the fourth week, but are confined only amongst comparatively younger plants of late-sown plots. Exotic types suffered more from this disease than the selections (types) maintained by the substitute fibre section of this Institute.

*The Fungus on Host.*—The fungus associated with the above symptoms develops innumerable spherical pycnidia, both on leaf and stem which are erumpent, separate, brown, ostiolate with a dark band of 'cells' round the ostiole, glabrous, thin-walled, wall-'parenchymatous', from  $61.92\ \mu$  to  $130.72\ \mu$ , mostly about  $110.0\ \mu$ , pycnosporae, 1-celled, hyaline but slightly bluish-green *en masse* held in sticky matrix during extrusion from pycnidium, thin-walled ellipsoid with somewhat pointed ends, mostly uniform in shape and size,  $6.1\ \mu$  to  $13.7\ \mu$  long and  $2.7\ \mu$  to  $4.1\ \mu$  broad, mostly  $10.8\ \mu \times 2.7\ \mu$ .

Perithecia develop subsequently when the tip of the plants are dry. Perithecia globose, slightly wider at the base, papillate, hairy-hairs short, dark-coloured, superficial (not erumpent), from  $115\ \mu$  to  $249\ \mu$ , mostly  $230\ \mu$  or more; asci many, cylindrical with narrower tail, wall-hyaline, regularly 8-spored,  $61.9\ \mu \times 9.8\ \mu$  to  $65.36\ \mu \times 10.32\ \mu$ , paraphyses absent; ascospores regularly 8 in each ascus, thick-walled, hyaline, lenticular,  $7.5\ \mu \times 4.1\ \mu$  to  $12.0\ \mu \times 6.1\ \mu$ , mostly  $10.0\ \mu \times 6.1\ \mu$ .

*The Fungus in Culture.*—Similar cultures were obtained both from pycnosporae and ascospores. Growth started with whitish sodden mycella, sometimes fluffy. In slants on potato dextrose agar, the upper half turned greyish brown due to development of pycnidia while the lower half turned dark due to development of dark-coloured sterile perithecia. Sometimes only pycnidia developed in culture and no perithecia.

The pycnidia in culture were regular in size, shape and colour (brown) and were typically ostiolate and compared well with those from nature. Pycnosporae were of irregular size and shape but mostly ellipsoid.

The perithecia in culture were dark, irregular in shape and sterile.

*Identity of the Fungus.*—From the characters described above, the pycnidial form appears to be a species of *Phoma* Desm. and

the perithecial stage in all likelihood belongs to the genus *Trichosphaeria* Fuckel. That the culture from pycnosporae and ascospores are same and that the perithecia are often found in association with the pycnidia show that the two forms are genetically connected.

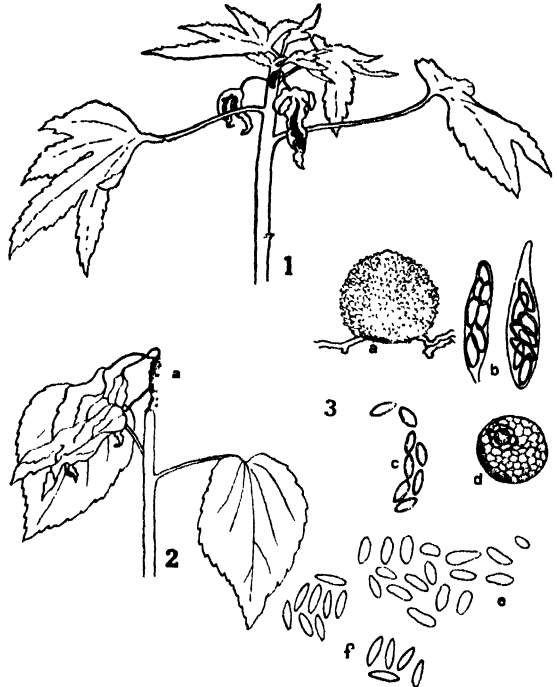

PLATE II

FIG. 1. Initial stage of infection; FIG. 2. Advanced stage of infection; (a) tip bearing pycnidia and perithecia; FIG. 3. (a) Perithecium; (b) asci; (c) ascospores from single ascus; (d) pycnidium; (e) pycnosporae in culture; (f) pycnosporae in nature.

*Evaluation of Resistance in Different Types.*—The disease was allowed to spread in the field and records of incidence of tip-rot was kept. It was found that *H. radiatus* a wild species and the  $F_4$  progeny from the single  $F_3$  plant (from a cross between *H. cannabinus*  $\times$  *H. radiatus*) surviving from the epidemic of 1955 proved resistant to tip-rot. It is significant that excepting *Phoma sabdariffae*, no other pathogen, normally prevalent on 'mesta', viz., *Rhizoctonia*, *Phytophthora*, etc., were found attacking these progenies. All type collection from Morocco, Poona, Dharwar, Vizag, Raigarh and Nagpur with the exception of only two, proved more or less susceptible to 'tip-rot'. The two selections along with those from  $F_4$  of *cannabinus*  $\times$  *radiatus* have been carried forward for further studies.

Thanks are due to P. Sanyal, our colleague in the substitute fibre section for helping us

in taking records in the various experimental crops mentioned above and to Dr. B. C. Kundu, Director, Jute Agricultural Research Institute, for valuable suggestions.

Jute Agricultural Res. Inst., T. GHOSH.  
Barrackpore, W. Bengal, N. MUKHERJI.  
November 13, 1957.

1. Ghos. T. and George. K. V., "Brown rot of Mesta (*Hibiscus cannabinus* Linn.)," *Indian Phytopathology*, 1953, 6, 106-09.

### MOLYBDENUM CONTENT OF A FEW FORAGE PLANTS OF WESTERN INDIA

It is as recently as 1939 that Arnon and Stout<sup>1</sup> had demonstrated the essentiality of molybdenum for plant growth. Its importance in nitrogen fixation and for nitrate reduction, its extensive use in fertilizers with resultant spectacular increases in pasturges and crop growth is today well established. However, though deficiencies of soil molybdenum have been reported from many parts of the world, no work has been done in this country so far with the exception of Dakshinamurthi *et al.*<sup>2</sup> who determined the molybdenum content of two Delhi soils.

Since the molybdenum status of forage plants is considered important from the viewpoint of animal nutrition, an attempt was made to study the molybdenum content of some dominant forage plants of W. India. Molybdenum was determined by the dithiol method of Piper and Beckwith.<sup>3</sup> The results which represent the average value of three samples each are reported in Table I.

It is observed that molybdenum is taken up in the smallest quantities and that forage plants are exceptionally low in molybdenum as to be classified as deficient. This is probably due to the low molybdenum content of the grassland soils, which will be shortly reported elsewhere. Though generally legumes are expected to contain higher amounts of Mo than grasses due to the presence of symbiotic bacteria, it is seen that grasses are higher in Mo content than legumes. The former contain 0.03 p.p.m. or more, while the legumes contain less than 0.02 p.p.m. Though the critical levels for Mo have not yet been established, it is generally considered that a value of 0.1 p.p.m. Mo in dry matter of plant tops is one below which Mo deficiency is likely.

TABLE I

Name of species		Average molybdenum content (p.p.m. of dry matter)
1 <i>Ischamum ciliare</i> Retz.	Grass	0.08
2 <i>Heteropogon contortus</i> L.	"	0.04
3 <i>Themeda triandra</i> Forsk.	"	0.05
4 <i>Themeda quadrivalvis</i> OK.	"	0.03
5 <i>Pseudanthistiria heteroclita</i> Hk.	"	0.04
6 <i>Arundinella tenella</i> Lawii.	"	0.04
7 <i>Dicanthium annulatum</i> Stapf.	"	0.06
8 <i>Eulalia fimbriata</i> Bl. & Mc.	"	0.05
9 <i>Indigofera tinctoria</i> L.	Legume	0.01
10 <i>Heylandia latebrosa</i> DC.	"	0.01
11 <i>Crotalaria lunifolia</i> Linn.	"	0.02
12 <i>Crotalaria triquetra</i> Dalz.	"	0.02
13 <i>Crotalaria filipes</i> Benth.	"	0.02
14 <i>Smithia sensitiva</i> Ait.	"	0.01
15 <i>Alysicarpus vaginalis</i> DC.	"	0.01
16 <i>Alysicarpus pubescens</i> Law.	"	0.02

The Mo deficiencies in the forage may have been induced by the acidic reaction of the soils or the depressing effect of other elements. Again, species differences may be reflected in the plant contents. Thomas and Anderson<sup>4</sup> have shown that a soil deficient in molybdenum for symbiotic nitrogen fixation in legumes was, however, not deficient in Mo to grasses. Grasses appear to have a greater capacity to absorb Mo than the legumes, though the latter require it much more. Since Mo intake is intimately connected with nitrogen metabolism, it is suggested that the protein content of forage plants of W. India may be affected and fail to meet the requirement of cattle. Further work is in progress along these lines.

Dept. of Botany, (MISS) JAYA G. IYER.  
Institute of Science, Y. SATYANARAYAN.  
Bombay-1, December 2, 1957.

1. Arnon, D. I. and Stout, P. R., *Plant Physiol.*, 1939, 14, 371.
2. Dakshinamurthi, C., Satyanarayana, K. V. S and Baljit Singh, *Proc. Nat. Acad. Sci. India*, 1955, 24, 566.
3. Piper, C. S. and Beckwith, R. S., *J. Soc. Chem. Ind.*, 1948, 67.
4. Thomas, M. P. and Anderson, A. J., *Council Sci. Ind. Research Bull.*, Australia, 1946, 196, 7.

---



---

 REVIEWS
 

---



---

**The Reactive Intermediates of Organic Chemistry.** By John E. Leffler. (Interscience Publishers, New York), 1956. Pp. 275. Price \$ 6.00.

The volume under review summarises, though very briefly, our present knowledge about various organic intermediate reactive radicals or ions which are of great interest to chemists engaged on investigations in high polymer chemistry and in the elucidation of mechanisms of various organic reactions. There is a chronology as it were of various types of radicals and details of methods of preparation, physical properties, and important reactions of these radicals have been dealt with up-to-date. Starting with a concise summary of chemistry of triaryl methyl radicals in the first chapter, the reader is taken through an account of various carbon radicals, diradicals from dark violet, porphyrine, rubrene, anthra quinone, hetero-radicals, semiquinone radicals, etc., in the subsequent chapters. Hetero-radicals from sulphur, nitrogen have also been dealt with. Evidence for the presence of carbonium ions by conductivity measurements, dielectric polarization, spectrophotometry, cryoscopy, etc., is given. Effects of structural changes in carbonium ion and solvent effects on ionization equilibria have been discussed. Formation and reactions of various carbonium and carbanion radicals have been dealt with exhaustively. The last chapter on radical and non-radical reactions listing substituent effects, solvent effects, catalysts, products, inhibitors, light and various diagnostic reactions to distinguish between two types of reactions will be found particularly useful by organic as well as physical chemists. However, after going through the volume one gets an impression that the treatment of radicals from organic peroxides and hydroperoxides as well as on inhibitors and retarders has been rather sketchy.

These minor lapses apart, the volume under review makes an extremely interesting reading and reveals the diverse nature of organic radicals and will be read with great interest by all investigators engaged on elucidation of mechanism of various types of organic reactions involving the transient species as the intermediates.

**Fundamentals of Chromatography.** By H. G. Cassidy. (Interscience Publishers, Inc.), 1957. Pp. xvii + 447. Price \$ 9.75.

This is Vol. X of Weissberger's *Technique of Organic Chemistry*, and is a successor to Vol. V, which was also by Professor Cassidy and was a more general treatise on adsorption and chromatography. Because of the great progress made in chromatography, and apparently in view of the fact that several books on methods and applications of chromatography are available, the present volume, which is an entirely new book and not a revision of *Adsorption and Chromatography*, has been devoted to a discussion of the fundamental principles of chromatography. It is complementary to Lederer and Lederer's *Chromatography*, a new edition of which appeared almost simultaneously. Lederer and Lederer have made a comprehensive and detailed review of chromatographic methods and their application to organic compounds of various classes, and they have stated in their preface to the first edition (1953) that "in view of the fact that a book by A. J. P. Martin and A. T. James on the Theory of Chromatography will be published by the Elsevier Publishing Co., we thought it unnecessary to encroach on this field". The Martin-James book has not yet appeared, and the book under review therefore fulfils a very real need.

After defining and classifying chromatography in two chapters, the molecular interactions on which chromatographic separations depend are explained in Chapter III. The succeeding six chapters give an excellent account of the general theory and of the principles, procedures and applications of partition chromatography (vapour-liquid, column, and paper), adsorption chromatography, and ion-exchange; an omission in the last of these chapters is the use of modified cellulose. Although no chromatographic applications of electron exchange resins have yet been reported, the short chapter on their preparation and behaviour is of interest because of their analogy to ion-exchangers. The next chapter deals with foam and emulsion fractionations, but it is doubtful if these can be considered to be chromatographic processes. Methods of recognizing and evaluating zones, the relation of  $R_f$  or  $R_p$  values to molecular structure, the choice of stationary and mobile phases, and the uses of chromatography are the

subjects of the four concluding chapters. Sources of chromatography equipment are listed in an Appendix.

K. V.

**Perspectives in Organic Chemistry.** Edited by Sir Alexander Todd. (Interscience Publishers), 1956. Pp. x + 527.

The decade after the Second World War has been a period of extraordinary achievement in the field of organic chemistry. The structures of many natural compounds of great complexity have been unravelled. Total syntheses, notably in the fields of steroids and alkaloids have demonstrated the power of the chemist as a builder rivalling Nature. The discovery of ferrocene, the first organic compound containing only carbon, hydrogen and iron has added zest to the quest for a better understanding of the nature of chemical bonds, and of aromatic character. The development of the theory of conformational analysis has rendered possible a better knowledge of polycyclic hydroaromatic systems like those present in steroids, terpenoids and in some complex alkaloids. The time is opportune for a survey of recent accomplishments in organic chemistry and for an assessment of problems awaiting solution. This task is admirably performed by the eighteen articles contributed to the volume under review by organic chemists who have themselves been in the vanguard of progress in the field of organic chemistry. Every one of these articles give ample evidence of the great erudition and critical acumen of the authors. The article entitled 'Synthesis' by R. B. Woodward, the foremost synthetic organic chemist of our time gives a brilliant exposition of the importance and fascination of the synthetic method in solving structural problems. The article on 'Nucleic Acids' by Sir A. R. Todd is a lucid exposition of the chemistry of a most complex group of natural substances and also incorporates a thought-provoking speculative analysis of the role of nucleic acids in transmission of hereditary characteristics. The article by W. Baker on the 'Concept of Aromaticity' presents a stimulating and comprehensive account of the efforts made towards achieving a fuller understanding of aromatic character. The article by K. Folkers on 'Micro-organisms in Organic Chemistry' will reveal to the organic chemists steeped in the classical tradition, the immense potentialities of the technique in achieving complex transformations, well-nigh impossible with classical methods.

The volume will be read with great pleasure by all organic chemists and constitutes a fitting

tribute to Sir Robert Robinson, one of the great masters of organic chemistry, on the occasion of his seventieth birthday.

T. R. G.

**Advances in Carbohydrate Chemistry, Vol. XI:** (Academic Press Inc.), 1956. Pp. xviii + 465. Price \$ 11.00.

The volume begins with a comprehensive review of the periodate oxidation of carbohydrates. With the exception of phenylhydrazine no other reagent has played so important a part in the field of carbohydrate chemistry and the chapter will therefore be found most useful by teachers and research workers alike. The second chapter gives an up-to-date account of the chemistry of ozones and will be particularly welcome since there are no adequate previous reviews of this group of compounds. The third chapter gives an account of the chemistry of substances formed by the action of  $\beta$ -ketonic esters on monosaccharides. The fourth chapter is on Kojic acid, an important metabolite produced by several micro-organisms from carbohydrate sources. This is followed by a chapter summarising present knowledge on the biosynthesis of monosaccharides of which about forty have been obtained from natural sources. Branched-chain sugars are rare in nature and a chapter dealing with these compounds is therefore of great interest. A chapter on nucleic acids is also included in the present volume. The last chapter is on certain aspects of the physical chemistry of starch with an addendum summarising recent work carried out on the size and shape of polysaccharide molecules. The present volume (XI) must like its predecessors find a place in every institution providing instruction in organic chemistry or engaged in research in this field.

T. R. G.

**Advances in Food Research, Vol. VII.** Edited by E. M. Mraz and G. F. Stewart. (Academic Press, Inc.), 1957. Pp. x + 404. Price \$ 9.50.

Seven valuable review articles have been contributed in the field of research on food which should prove of stimulating interest to various new developments in biochemical, technological and industrial aspects of food in India.

The first chapter on "Profile Method of Flavour Analysis" by J. F. Caul lucidly describes a proper human approach to testing of various food commodities by judicious selection and proper training of panels. Y. Tomiyasu and B. Zenitani have critically examined the

different aspects connected with "Spoilage of Fish and Its Preservation by Chemical Agents". Moreover, they have thoroughly reviewed the literature on various biochemical aspects associated with autolysis of fish. Though importance of preservation of quality by recourse to proper freezing storage has been stressed, yet the use of antibiotics, *e.g.*, aureomycin-ice is well worth a detailed study in different climatic conditions.

In a masterly article on "Water Relations of Food Spoilage Micro-organisms" by W. J. Scott, the correlation with physico-chemical constants of water, *e.g.*, water activity, equilibrium humidity, freezing point, osmotic pressure, etc., with various species of micro-organisms in different environments is systematically reviewed. Such an appreciation will promote solution of several microbiological and biochemical problems connected with chemical and enzymic reactions in the presence of water. The germicidal action of chlorine in food plant sanitation is reviewed by W. A. Mercer and I. I. Somers, who stress its effect mainly in inhibiting microbial growth and discuss its mode of action, indiscriminate use and shelf-life of food products. The technological and applied aspects of "Freeze-Drying of Food Products" is well compiled by J. C. Harper and A. L. Tappel. Though freeze-drying of foodstuffs is economically not feasible, its use in times of emergency as well as for preservation and transportation of blood plasma has been largely made use of in different countries.

The manufacture of gelatin coupled with the structural characteristics as well as its various applications are well illustrated by B. Idson and E. Braswell, and the concluding chapter by C. Nieman is appropriately on a flavouring agent "Licorice" which has found extensive usage in confectionery, tobacco and brewery industries and has also wide applications in pharmaceuticals.

H. R. CAMA.

**Fundamentals of Immunology.** Third Edition. Completely revised and rewritten. By Prof. William C. Boyd. (New York: Interscience Publishers, Inc.), 1956. Pp. xiv + 776. Price \$10.00.

Though the basic plan of the third edition of the book remains the same as in its first, the book has expanded considerably in size, with 716 pages and 24 pages for index now, as against 446 pages and 16 for index in 1943. Despite the substantial increase, however, many

important topics have not received attention, a particularly unfortunate omission being that on the use and effects of Cortisone and ACTH.

The early chapters dealing with the basic aspects of immunology like antigens, antibodies and their reactions give a detailed account of the subject that fully justifies the title of the book as well as the claim that it is addressed primarily to students and research workers. It is refreshing to note that the author has reversed many of the opinions expressed in earlier editions in the light of newer work, as for instance on the valency of antibodies. The sections dealing with anaphylaxis, allergy and hypersensitivity in the earlier editions have been considerably expanded and rewritten, while a new chapter has been added on auto-immunization and disease. These changes will prove very useful to the students. Another valuable addition is the considerably expanded and modernized discussion on statistical methods. It would have been more convenient in view of its 42 pages to separate it into a chapter with the relevant title instead of keeping it hidden under the sub-heading, "Titration of antisera, toxins, etc."

Some occasional and unfortunate lapses are in evidence requiring correction, as for instance the confusion between types and strains among influenza viruses shown in statements repeated on pages 208 as well as 518. "There are two principal strains of virus designated as A and B".

When dealing with prophylaxis against rabies, only rabbit brain vaccine is mentioned. The incidence of post-treatment encephalitis is higher with rabbit brain vaccine, *viz.*, 1 in 600 to 1 in 7,000 as quoted than with the sheep brain vaccine that is in use over large areas of the world. The figures for this complication are as low as 1 in 21,000 over a period of 23 years' experience at the Pasteur Institute, Coonoor, with 5% sheep brain vaccine.

In discussing the value of T. A. B. Vaccine, the author, strikes a note of pessimism. The controlled trials in progress in Yugoslavia under the auspices of the World Health Organization should give us an indication of its value and prove whether his extrapolation is rash or not.

The last chapter of the book fittingly enough deals with laboratory technique. Though it covers a large number of tests, it is unlikely to enable a beginner to carry them out, as details are lacking. Even the theoretical discussions are inadequate for the research worker as the pitfalls and fallacies, particularly in interpre-

tation of the results, have not been dealt with adequately.

Despite the few drawbacks mentioned above, the third edition of this book can safely be accepted as a valuable addition to the standard books on immunology.

N. V.

**Physiology and Pathology of the Kidney.**  
(*British Medical Bulletin*, Vol. 13, No. 1).  
January 1957. Pp. 74. Price £ 1.

This volume of just 70 pages contains an extraordinary amount of valuable material on recent advances in renal functions as well as in the understanding of renal diseases and their treatment. Problems concerning the relationship between the kidney and potassium on the one hand and sodium on the other, have been dealt with very clearly by well-known authorities on the subject. Apart from dealing with what may be regarded as primary diseases of the kidney such as the *nephrotic syndrome*, there are also articles dealing with what happens in the kidney in experimental hypertension. Metabolic results of interference with renal function in childhood, in old age and by over-nutrition form the subject of two papers. The modern techniques in the radiographic demonstration of the arterial and venous supply of the kidneys have been described with appropriate X-ray diagrams.

Like other issues of the *British Medical Bulletin*, this volume must be in the library of every modern physician.

K. S. S.

**Symposium on Anesthesiology and Related Problems.** (*Annals of the New York Academy of Sciences*, Vol. 66, Art. 4), 1957. Pp. 841-1022. Price \$ 4.00.

The symposium under review is by a number of authors; it is divided into four parts. Information of use to the general practitioner is scanty. The articles have been contributed by specialists and discuss different approaches to anaesthetise older people and the difficulties encountered; theoretical aspects are also discussed. Some of the information presented is more competitive than contributive, and integrated information to the overworked reader is not readily available. This volume, therefore, should be made available in libraries where research is being conducted.

The subject of geriatric anaesthesia is introduced by Collins and ageing is sought to be defined. Geriatric medicine may be said to begin when treatment has to be given to per-

sons over 60 years of age; this definition is arbitrary; it should allow of modifications made to suit older people to bring about anaesthesia, from the experience that is available from anaesthetising less older people. Charles M. Barbour discusses nutritional and haematological factors bearing on anaesthesia. He emphasises the importance of correcting by prophylactic methods before any elective operations are performed. Abnormalities of blood and altered physiological functions in older people, are emphasised as the commonest risks. Haemoglobin concentrations and shifts of electrolytes are discussed by Newman. The question of hypoxia in persons with chronic conditions are discussed. Newman also presents the subject of cardiovascular complications in aged people with reference to anaesthesia such as cardiac arrhythmias, hypotension, coronary insufficiency, venous non-return, which are great risks. The question of minor cardiac conditions is also discussed. Hickam discusses fully the uses of mechanical respirators in subjects whose lung capacity has been lessened, that is, with high resistance and low competence. To persons, who are interested in the Seeler Respirator and other such mechanical devices, this paper should be useful. The question of anaesthesia for older persons is discussed by Stephen. He quotes Ralph Knight's statements wherein it is said, "what they require particularly is conservatism with a little daring, but with unceasing vigilance and nicety and exactness of administration with control". In *Choice of Anaesthesia for Geriatric Patients*, Stephen states that "one learns the extent of physiological insult to which average healthy adult can, on occasion, be exposed during operation, without irreparable damage to vital organs, is large; but the allowable error in anaesthetic administration is within narrow range. Lack of resilience, question of associated diseases and physical and mental conditions, among the aged are to be remembered". In Part II, the question of controlled respiration during anaesthetic practice, is discussed by Spencer, Maloney *et al.*, Little and Papper. These articles present both theoretical aspects and the practical personal experience of the authors. In Part III, the fluid and electrolyte balance in surgical aspects are presented by Randall, Harris and Cooper. Respiratory Alkalosis, Pediatric Problems and Isotopes Study in an Electrolyte Balance, contributed by such Isotope Studies, are presented by Roberts, S. Harris and M. Cooper. Hypotension with its risks in the operating room by anaesthetics,



mineral dreno-corticoid insufficiency and blocking of the autonomous nervous system are discussed extensively by Patrick, Burstein, Aviado. The protective mechanism on shock is presented by B. W. Zweifach *et al.*

The symposium presents useful viewpoints and should be available for consultation when problems arise.

C. V. NATARAJAN.

**Common Medicinal Plants of Darjeeling and the Sikkim Himalayas.** By K. Biswas. (Published by the Superintendent, Government Printing, West Bengal Government Press, Alipore, West Bengal), 1956. Pp. vi + 157. Price: Indian, Rs. 7; English, 11 sh. 3 d.

The book is intended to serve as a concise account of the plants of medicinal importance found in the Sikkim Himalayas and Darjeeling. The author, Dr. K. Biswas, was formerly the Superintendent of the Indian Botanic Garden (formerly the Royal Botanic Gardens), Calcutta, which is considered by many scientists as second only to the Kew Gardens. Under the auspices of the Medicinal Plants Committee of the Indian Council of Agricultural Research, investigation of the vegetable drug resources of the Indian sub-continent has been undertaken and work is going on at two important centres in the Himalayas. The Western Zone under the charge of Bt.-Col. Sir R. N. Chopra has its work done at Srinagar and Jammu, and the Eastern Zone with centres at the Rongo Hills and Calcutta is under the supervision of Dr. Biswas. Thus the author of the book is eminently fitted to write with authoritativeness about the plants of Darjeeling and the Sikkim Himalayas.

The book gives short notes on 152 species of plants grouped into families. Since many of these species are not confined to Darjeeling and the Sikkim Himalayas only, one will immediately recognise that a good bit of the matter in this book is already to be had in one or more earlier books written with a similar purpose. Each monograph begins with a brief botanical description of the plant in the usual telegraphic style with which all botanists are quite familiar. This is followed by a line or two on the distribution of the plant. Then follows a mention of the parts used, and finally comes a brief description of the real or alleged medicinal uses.

At the end of the book there is a collection of 50 plates illustrative of selected species described in the main body of the book. This adds very considerably to the usefulness of

the book. Five introductory chapters covering 26 pages and 9 photographs of plantations precede the monographs. There is a Preface by the author and a Foreword by Bt. Col. Sir R. N. Chopra. There is an index of specific names at the end.

The literary aspect of the book leaves much to be desired. Spelling mistakes are not too infrequent, grammar has been occasionally lost sight of, and many of the statements will be jarring to people used to good English. To give some examples of each of the above defects, "invigorating" has an extra 'u' before 'r' (p. 57); "epilepsy has an extra 'l' (p. 62); "sandal" is written as "sandle" (p. 70), "anus" is written as "annus" (p. 73); "ketonic" as "katonic" (p. 74); "contipedes" as "centipeds" (p. 76); and "aphrodisiac" as "aphrodisac" (p. 79). On page 81, "bring" is evidently a misprint for "burning". On page 62, a sentence reads: "It also used in irregular monthly courses and other troubles of the women", and another reads: "The oil has the property of increasing growth of hairs on the head." One fails to catch the meaning of the following statements found on page 76: "Rhubarb is stomachic, tonic and cathartic so that its secondary effect is to confine the bowels... It is stimulating combined with its aperient properties render it valuable in atonic dyspepsia".

The reviewer feels that most of these errors could have been avoided in the final print if sufficient care had been taken at the proof stage and a good dictionary had been made greater use of. One would wish that this be done at the next printing.

Notwithstanding the defects pointed out, the book would serve as a useful source of information to administrators and scientists who may be concerned with the development of the region covered by the book, and to investigators, whether botanical, chemical, pharmacological or clinical, who would like to know where a particular drug plant required for their investigation could be had.

S. R.

**A Practical Guide to Plant Sociology for Foresters and Agriculturists.** By F. R. Bharucha and W. C. De Leeuw. (Orient Longmans), 1957. Pp. viii + 46.

This publication is a very welcome addition to the scanty Indian literature on the subject. Prof. F. R. Bharucha is an exponent of the Zürich-Montpellier School of Plant Sociology which has stood for quantitative evaluation of plant communities. The system has been successfully applied to grassland and ruderal

vegetation in this country. The authors have now placed a practical guide in the hands of Indian ecologists, who may adapt it with suitable modifications for the study of tropical forests.

There are seven chapters in the book. The first two are devoted to the selection of homogeneous stands of vegetation and methods of determining analytical and synthetic characters of plant communities. The authors next proceed to describe life forms and preparation and significance of biological spectrum. The process of succession and evaluation of the role of species in the phenomenon are briefly indicated. Problems of nomenclature and cartography are discussed before ending with a chapter on the value of plant sociology in land use.

The authors are to be congratulated for the service they have rendered in extending ecological studies in this country which has been so far much neglected. The book will be useful to all students of botany whether they are working in forestry, agriculture or other branches. For this reason alone and also because the illustrations given in the text mostly refer to grassland communities, deletion of the words 'for Foresters and Agriculturists' from the title of the book is advisable.

It is necessary here to point out certain errors and omissions which have crept into this valuable guide, for incorporating them in its second edition. On p. 23, line 2, 'at the level of' should be read as 'under' and in line 8, 'from' should be changed into 'upto', in order to distinguish Geophytes from Hemicryptophytes and Chamæphytes from Phanerophytes. On p. 38, lines 15-17, contradictory statements appear in the same sentence regarding physiognomical homogeneity. Sample charts and diagrams based on local data and a note on frequency of species in communities are most needed in the guide and should be added.

R. MISRA.

**Glossary of Indian Medicinal Plants.** By R. N. Chopra, S. L. Nayar and I. C. Chopra. (Published by the Council of Scientific and Industrial Research, New Delhi), 1956. Pp. xx + 330. Price not given.

The senior author is a pioneer in the field of medicinal plants and the yeoman services he has rendered from the time he was the Professor of Pharmacology in the Calcutta School of Tropical Medicine to date when he is in charge of the Kashmir Government's Medicinal Plants Scheme are noteworthy. The book under review brings in the compass of

one tome much information that is scattered in a wide field of scientific literature on the subject of medicinal plants, which are arranged here alphabetically according to their genera.

The vernacular names given serve a useful purpose. The uses in Indian Medicine, however, are too broad and vague to be really helpful. A rational use of drugs is not possible unless the fundamentals of system of medicine are grasped. The chemical composition and distribution are welcome. A very desirable feature is the suggested list of the drugs whose investigation is likely to be useful.

There are two comprehensive indices, one of the common vernacular names and the other of the chemical constituents.

K. S. RANGANATHAN.

### Books Received

*The Survey of India during War and Early Reconstruction, 1939-46.* By Sir Oliver Wheeler. (Office of the Geodetic and Research Branch, Survey of India, Dehra Dun.) Pp. xii + 317. Price Rs. 23.

*Introductory Nuclear Physics.* Second Edition. By David Halliday. (Asia Pub. House, Contractor Buildings, Bombay-1.) Pp. ix + 493. Price Rs. 17.50.

*The Darwin Reader.* Edited by Marston Bates and P. S. Humphrey. (Macmillan & Co.) Pp. ix + 481. Price 30 sh.

*Proceedings of the Third British Weed Control Conference, 1956, Vols. I & II.* (The Secretary, The British Weed Control Council, 61, Curzon Street, London W.1.) Pp. xiv + 870. Price £ 2-2-0.

*The Rolling of Strip, Steel and Plate.* By E. C. Larke. (Chapman & Hall, London; India: Asia Publishing House, Bombay-1), 1957. Pp. xi + 404. Price 63 sh.

*Laboratory Manual of Batch Distillation.* By F. J. Zuiderneg. (Interscience Pub. New York; India: Asia Publishing House, Bombay-1), 1957. Pp. viii + 126. Price \$ 3.50.

*The Chemistry of Heterocyclic Compounds—Phenazines.* By G. A. Swan D. G. I. Felton. (Interscience Pub., New York.) Pp. xix + 693. Price \$ 22.50.

*University of Bombay—Botanical Memoirs No. 3—Precipitation Effectiveness in Relation to the Vegetation of India, Pakistan and Burma.* By F. R. Bharucha, G. Y. Shanbhag. (The Registrar, University of Bombay, Fort, Bombay.) Pp. vii + 109. Price Re. 1.50.

---



---

## SCIENCE NOTES AND NEWS

---



---

### New Fossils from Madhya Pradesh

The marine Permo-Carboniferous rocks reported by S. Ghosh and A. K. Datta from Manendragarh (82° 12'; 23° 13'), Jhagrakhand in Madhya Pradesh have been examined recently by B. S. Tewari, Geology Department, Lucknow University. Apart from the two marine fossiliferous localities so far reported from this area, two new spots along the right bank of the river Hasdo have been observed, which have yielded marine assemblage. These new spots are situated upstream of the two already known localities. Not only the conglomerate immediately overlying the Archæan gneiss is fossiliferous, but the next successive beds, which are needle shales and the band of sandstone, also yielded marine fossils. The conglomerates, needle shales and the band of sandstone are in a conformable sequence and dip at an angle of 30° towards S 5° W. Besides the fossils already reported from the conglomerates by Datta, others such as *Spirifer nitiensis?*, *Protoretzpora ampala*, *Lima*, *Pterinea*, a small species of *Pleurotomaria* and badly preserved tests of arenaceous foraminifers have been found. The fauna resembles to that of Lower Permian of Kashmir and Salt Range.

Just at the south-east end of Naurozabad railway platform on the Katni-Bilaspur Branch Line of Central Railway, a new locality of Intertrappean fossils has been observed. The specimens are found in a hard siliceous rock, which is seen along the main line as well as the colliery siding for a couple of yards. *Physa (Bullinus) prinsipii*, *Paludina* and *Lymnæa* have been provisionally identified. A detailed report will be published elsewhere.

### Prevention of Moss Growth in Concrete Races

Moss and other plant growth can block hydroelectric power station supply races, particularly in high, cold country. The Division of Industrial Chemistry of C.S.I.R.O., Australia, has devised a simple treatment which prevents fouling of the races.

Plant growth on the races at the Rubicon Station in Victoria has restricted the water intake (and hence the maximum power output of the Station) by more than 10%. Cutting and scraping fails to achieve satisfactory control since the plants regenerate and foul

the races again in less than 6 months. Further it is difficult to shut off water from the races for these operations.

The successful treatment involves cleaning the races and applying a cement or sodium silicate rendering containing small quantities of either elemental sulphur or certain copper compounds. These materials are toxic to moss but are insoluble in water and do not cause any pollution of the water-supply.

The treatment has already kept races free of moss for more than 2 years.

### Roasting Copper Concentrates

Four major copper-producing companies in Australia have co-operated with the C.S.I.R.O. Division of Industrial Chemistry in the development of a new method of roasting copper concentrates.

The new method involves the "fluid bed" technique in which a stream of gas is blown upward through powdered solid material. If the speed of the gas is carefully controlled, the solid particles are kept suspended and behave rather like a violently agitated liquid.

Successful application of the fluid bed technique to "roasting" copper ores involved the development of an entirely new design for the base of the roaster. This consists of a series of deep, tapering holes in a base made of refractory concrete. At their upper ends these holes are large enough to meet in a honeycomb pattern occupying most of the cross-section of the roaster.

With conventional designs of base, lumps formed in the stream of ore particles and clogged the roaster. In the new design the lumps are broken down in the fast-moving air stream.

The work is now being extended to include improvements in methods of extracting copper from the roasted ore by the electrolytic process.

This method is particularly suitable for treating sulphide ores on the medium-scale of operations required by the Australian companies.

### Instrumentation for Gas Chromatography

The Scott microflame detector has now been made available commercially for gas chromatography (Shandon Scientific Co., Ltd., 6, Cromwell Place, London, S.W. 7). This novel detector (Scott, R. P. W., "A New Detector for

Vapour Phase Partition Chromatography"; see "Vapour Phase Chromatography", edited by D. H. Desty, p. 131; Butterworth, 1957) depends on the use of a carrier gas containing a considerable proportion of hydrogen, which is burnt in a small flame near the column exit. The presence of an organic vapour in the gas increases the length of the flame and this results in a comparatively large response from a thermocouple situated just above the normal flame. The advantages of this detector are that it has an extremely small effective volume, resulting in a very rapid response; and secondly, that its response is directly proportional to the calorific value of the vapour; which means that in the analysis of hydrocarbons, calibration of the detector for individual compounds is unnecessary. (*Nature*, 180, 530, 1957.)

### A New Method of Analysing Cardiac Functions

Diagnosis by ultrasonic methods has been developed chiefly for the detection of the cancer tissue as slight changes observed in the transmittivity or the reflectivity of the applied ultrasonic pulse. A new method has been developed to analyse the functioning of the heart and the method is characterised by the use of Doppler effect caused by the mechanical motion of the heart for the inspection of cardiac functions. When the continuous ultrasonic wave is sent forth towards the heart from the surface of the chest wall, the cardiac motion causes Doppler effect upon the partial wave reflected from it. If an appropriate probe of sending and receiving the ultrasonic wave is available, it is possible to obtain the A.F. signal (the Doppler frequencies) frequencies which are proportional to the motional velocity of the reflecting part of the heart, by means of a composite demodulation of the reflected wave with the direct one. By means of this method it is possible to inspect the motion of the heart wall, the movement of the valves and the heart noises produced in a diseased heart. (*Jour. Acoust. Soc., Amer.*, 29, 1181, 1957.)

### Synthetic Geraniol

Glidden International C.A. Southern Chemical Division, Rootes Building, Nassau, Bahamas, announce that synthetic geraniol is now being produced on a commercial scale.

Manufacture of synthetic terpene alcohols and related aromatics of high purity is an event of great significance to those countries which grew or cultivated the raw materials from which these aromatics were extracted.

Geraniol, which is an example of terpene alcohols, has hitherto been extracted from the oil of citronella grass which grows in India, Ceylon and elsewhere. These countries have been exporting the oil to Europe and U.S.A. and the oil which is extracted from a product of vegetable origin could never be of a constant quality. Whereas synthetic geraniol, in the manufacture of which turpentine is the starting material, could always be relied upon to have a standard quality which is claimed to possess minimum total alcohol content of 98% and free from terpenes and sesquiterpenes. How far these synthetic aromatics will effect the citronella oil producing countries remains to be seen.

### French Electronic Invention

What is claimed as an important French invention, the "tecnetron", a supertransistor, which is expected to make possible great advances in the fields of television, guided missiles and telecommunications, was announced. It is the work of a French engineer, M. Tezner, and was developed at the National Centre of Telecommunications Study.

The great advantage of the tecnetron is said to be that it operates as an amplifier on frequencies of up to 500 and perhaps 1,000 megacycles a second. It is therefore capable of much wider application than the transistor, and its manufacture is claimed to be somewhat simpler.

It consists essentially of a strip of uranium about one-twelfth of an inch long and one-fiftieth of an inch in diameter, which is given the shape of a small pulley. The core is coated with indium, a rare metal, and three electrodes are soldered to the two ends. The tecnetron will shortly be tested in rockets fired to a height of 200 miles.

### Evidence for Vegetation in Mars

A new test for the presence of vegetation in Mars depends on the fact that all organic molecules have absorption bands in the vicinity of  $3.4\mu$ . These bands have been studied in the reflection spectrum of terrestrial plants, and it is found that for most plants, a doublet band appears which has a separation of about  $0.1\mu$  and is centered about  $3.46\mu$ . Spectra of Mars taken during the 1956 opposition indicate the probable presence of this band. This evidence and the well-known seasonal changes of the dark areas make it extremely probable that vegetation in some form is present. (*Astro-phys. Jour.*, 126, 231, 1957.)

### Botulism

Botulism has always aroused an interest out of all proportion to its frequency as a cause of food poisoning. Every medical student probably knows that botulism is the model example of the action of an exotoxin which can cause death even if the organisms which produced it are no longer alive, and that the dose necessary to cause death is minute.

Its epidemiological importance is discussed by K. F. Meyer in a review of botulism as a world health problem. He states that "throughout the world during the past 50 years approximately 5,635 persons contracted botulism and 1,714 of these persons died". Meyer discusses successively the incidence of human and animal botulism throughout the world, the distribution of *Cl. botulinum* in nature, and the foods and types of *Cl. botulinum* associated with human botulism.

It is estimated that in the Union of South Africa alone 100,000 cattle die of botulism every year. Animals reared on phosphorus-deficient veldt apparently crave the bones of carrion, which may be highly toxic from contamination with *Cl. botulinum*. So far as the human disease is concerned, the danger arises always from carelessness in the preparation and preservation of vegetable and animal foods. Many outbreaks have followed home canning of vegetables, and it is essential that all forms of food processing should be carefully controlled. Only in this way is it possible to eliminate completely the risk of botulism.

### New Radio Communications System

The world's first over-the-horizon microwave radio link in regular commercial service has been put into operation between Italy and Spain. A number of such systems is being installed in various parts of the world. The extension of microwave radio communication beyond the optical horizon was once thought to be impracticable, but fourteen years of intensive research has established the technique of troposphere forward-scatter, whereby microwave communication can be reliably established between points as far distant as 350 miles. The troposphere is the layer of the atmosphere which lies about ten miles above the earth's surface. Unlike an optical mirror, it has no sharply defined surface that remains fixed in space but rather a broad region from which electromagnetic waves are scattered in an irregular pattern that varies from moment to moment. The forward scattering technique promises important changes in radio communication.

### Living Polymers

Experiments show that anionic polymerization of certain vinyl monomers such as styrene, carried out under appropriate conditions, does not involve a termination step (e.f. Szwarc and collaborators, *J. Amer. Chem. Soc.*, 79, 2026, 1957). Polymers formed in this manner are able to continue their growth if a fresh portion of monomer is added after the complete conversion of the original monomer. If a monomer B is added to a block of living polymer A.....A a block copolymers is formed. The original polymer A.....A may possess one or two "living" ends and therefore a variety of block copolymers can be prepared by relatively simple experimental techniques.

### Ultrasonics in Electroplating

Chemists working at Western Reserve University in the United States have recently announced that they could obtain improved adhesion, harder and brighter plating with less porosity by employing ultrasonic agitation instead of conventional agitation in electroplating.

In electroplating deposits tend to build up at prominent points of irregularly-shaped parts, while leaving the recessed surfaces with depleted share. This difficulty has been avoided since the ultrasonic high intensity vibrations induce cavitation which has the effect of preventing concentration gradients to produce an even layer.

### Mechanics of Real Fluids

A Symposium on the above subject will be held from 21st April to 30th April 1958, at the Indian Institute of Technology, Kharagpur. A programme has been drawn up which includes Boundary Layer Theory and Application to Engineering Problems, Resistance of Pipes, Plates, Submarine Forms and Ship. Cavitation Phenomena, Flow through Porous Media, Atomisation, Vortex Tube, Thermo-Hydrodynamics, Cascade Flows, Rheo Electrical Analogy Methods, Model Science, Compressible Flow and Supersonic Flow.

All communications should be addressed to Professor S. N. B. Murthy, Mechanical Engineering Department, Indian Institute of Technology, Kharagpur.

### Symposium on Spectroscopy

The Second Annual Symposium on Spectroscopy organised by the Convention of Spectroscopists, was held in Madras (India), on Sunday, the 5th January 1958.

Scientists from Universities and other research establishments took part in the Symposium.

Papers on Molecular Spectroscopy, Nuclear Spectroscopy, Paramagnetic Resonance Spectroscopy and Microwave Spectroscopy were read and discussed.

#### Institution of Chemists (India) Associateship Examination, 1958

The Eighth Associateship Examination of the Institution of Chemists (India) will be held in November 1958. The last date for receiving applications from the intending candidates is 31st July 1958. The Examination in Group A (Analytical Chemistry) is divided into the following nine sections and the candidates will be examined in any two of them according to their choice, in addition to the General Chemistry including Organic, Inorganic, Physical and Applied Analytical Chemistry: (1) Analysis of Minerals, Silicates, Ores and Alloys; (2) Analysis of Drugs and Pharmaceuticals; (3) Analysis of Foods; (4) Analysis of Water and Sewage; (5) Biochemical Analysis; (6) Analysis of Oils, Fats and Soaps; (7) Fuel and Gas Analysis; (8) Analysis of Soils and Fertilisers; and (9) Analysis connected with Forensic Chemistry.

Further enquiries may be made to the Honorary Secretaries, Institution of Chemists (India), Chemical Department, Medical College, Calcutta-12.

#### National Institute of Sciences of India

The Twenty-Third Annual General Meeting of the National Institute of Sciences of India was held on the 5th January 1958, in the new Senate Room of the University of Madras, Madras. The President, Prof. P. C. Mahalanobis, delivered his address on "Science and National Planning". The following have been elected as office-bearers for 1958: *President*: Prof. P. C. Mahalanobis (Delhi); *Vice-Presidents*: Dr. V. R. Khanolkar (Bombay); Prof. D. S. Kothari

(Delhi); *Treasurer*: Prof. Ram Behari (Delhi); *Foreign Secretary*: Dr. B. Mukerji (Lucknow); *Secretaries*: Sri. S. Basu (Delhi); Prof. P. Maheshwari (Delhi); *Editor of Publications*: Prof. R. C. Majumdar (Delhi).

#### Indian Botanical Society

The Thirty-Seventh Annual General Meeting of the Indian Botanical Society was held in Room No. 21, University Buildings, Madras, on January 6, 1958, with Dr. S. K. Pande in the Chair. The following were elected as office-bearers of the Society for the year 1958: *President*: Dr. R. Misra, Banaras; *Vice-Presidents*: Dr. S. K. Pande, Lucknow, and Dr. P. Maheshwari, Delhi; *Hon. Secretary*: Dr. J. Venkateswarlu, Waltair; *Hon. Treasurer and Business Manager*: Dr. T. S. Sadasivan, Madras.

#### Indian Society of Genetics and Plant Breeding

At the Eighteenth Annual General Meeting of the above Society held at Madras on 6th January 1958, the following office-bearers were elected for 1958: *President*: Prof. P. N. Bhaduri; *Secretary*: Dr. M. S. Swaminathan; *Treasurer*: Dr. N. L. Dhawan; *Editor*: Dr. B. P. Pal.

#### Award of Research Degree

The University of Saugar has awarded the Ph.D. Degree to the following candidates for theses indicated against each: Dr. Sakti Prasad Banerjee, "The Influence of Chemical Constitution on the Rotatory Power of Optically Active Compounds"; Dr. Chand Narain Kachru, "Synthesis of Possible Amoebicides"; Dr. K. Govinda Kaimal, "Formation of Complex Compounds between Cadmium Chloride and Alkali Chlorides"; Dr. H. D. Sharma, "Studies in Silent Electric Discharge and Joshi Effect in Air"; Dr. K. C. Chandy, "X-ray Diffraction Studies of Solid State".

186-58. Printed at The Bangalore Press, Bangalore City, by C. Vasudeva Rao, Superintendent, and Published by A. V. Telang, M.A., for the Current Science Association, Bangalore.

All material intended for publication and books for review should be addressed to the Editor, *Current Science*, Raman Research Institute, Bangalore-6.

Business correspondence, remittances, subscriptions, advertisements, exchange journals, etc., should be addressed to the Manager, Current Science Association, Raman Research Institute, Bangalore-6.

#### ANNUAL SUBSCRIPTION

India: Rs. 8-00. Foreign: £ 0-16-0. \$ 2.50.

*All In One*

**INDEX**  
REAGENT BOTTLES

*Made by*

**Sigcol**



*Sole Distributors*

**GHARPURE & CO.**  
P36, ROYAL EXCHANGE PLACE  
EXTENSION - CALCUTTA-1

GRAM:MEENAMO PHONE:22 2061

**VERY RELIABLE INDIGENOUS SUBSTITUTES  
OF GUARANTEED ANALYTICAL REAGENTS  
MAY BE FOUND IN**

**"BASYNTH"**

**Brand**

**ANALYTICAL REAGENT**

Acid Hydrochloric  
Acid Hydrochloric Fuming  
Acid Sulphuric  
Acid Nitric  
Acid Nitric Fuming  
Acid Acetic Glacial  
Ammonium Hydroxide  
Benzene  
Toluene  
Xylene  
Petroleum Ether  
Amyl Alcohol  
Butyl Alcohol Etc., Etc.

**Basic & Synthetic Chemicals (Private) Ltd.**  
P. O. Jadavpur College, Calcutta-32

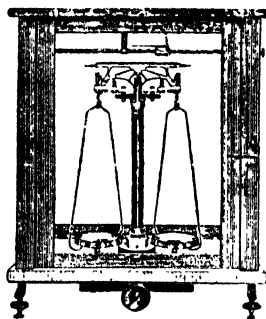

**KEROY**  
**Short Beam**  
**Analytical**  
**Balance**

No. K 1

A Really Dependable Balance for Degree  
Classes and Research Laboratories

Sensitiveness .. 1/10th mg.

Capacity .. 200 gm.

Fitted on  $\frac{3}{8}$ " thick glass base Price: **Rs. 325/-**

Catalogue on Request

*Manufactured by:*

**Keroy (Private) Ltd.**

BANARAS CANTT. :: CALCUTTA 10

"Calcutta Telephone No. Is 24-3840."

**MOST RELIABLE INDIGENOUS SUBSTITUTES OF  
GUARANTEED ANALYTICAL REAGENTS  
MAY BE FOUND IN**

**OSTER BRAND**  
**ANALYTICAL REAGENTS**

- \* ACID HYDROCHLORIC
- \* AMMONIUM HYDROXIDE
- \* ACID NITRIC
- \* ACID SULPHURIC
- \* LABORATORY CHEMICALS

*For Price List and Agency to:*

MANAGING DIRECTOR

Sri. CHUNILAL DATTA, B.Sc.  
(Late Senior Demonstrator of  
Chemistry, Vidyasagar College,  
Calcutta)

**OSTER CHEMICAL &  
PHARMACEUTICAL WORKS (P) LTD.**

*Regd. Office:*

78 B, Manicktala Street, CALCUTTA 6

*Works:*

Bagmari Road, CALCUTTA

TELEPHONE: 35-2052

# QUANTUM PHYSICS AND PHILOSOPHY

ALFRED LANDÉ

*Ohio State University, Columbus, Ohio, U.S.A.*

QUANTUM THEORY, born in 1900, has followed a path of opposition to the principles of classical physics, exemplified by Planck's discrete energies  $E = h\nu$ , Einstein's photons in contrast to the field theory of light, and Bohr's quantum jumps of electrons emitting long coherent wave trains. The year 1926 brought the further amazing realization that observed data are interconnected by the laws of a complex imaginary quantity  $\psi$  and by a non-commutative algebra in which the product  $A.B.$  differs from  $B.A.$  Since that time physicists know well how to calculate energy levels of atoms and molecules, and how to compute probabilities of transition, collision, and scattering. The earlier curiosity as to the 'why' of the strange mathematical formalism has given place, however, to a complacent attitude of accepting an enigmatic wave-particle duality and complementarity as the ultimate and irreducible basis of natural phenomena, deemed fundamental not only in the domain of microphysics but also affording a better understanding of biology, psychology, sociology, and so forth. In spite of this claim to fundamentality and universality, scientists and philosophers may still wish to make sure whether the quantum principles are indeed as ultimate and irreducible as alleged, or whether they may be deduced from a less sophisticated background after all.

There are three major "quantum riddles" to wit: Are there elementary reasons for:

- (i) the lack of sufficient causation, *i.e.*, for the statistical character of atomic laws?
- (ii) the domination of the statistical laws by a wave-like interference of probabilities?
- (iii) the periodic connection between co-ordinates  $q$  and momenta  $p$  ( $p = h/\lambda$ ) and between energy and time ( $E = h\nu$ )?

The solution of these problems has been delayed chiefly by the historical development which presented us with an intricate mixture of all three problems. For example, the famous Schrödinger equation yields probability relations between possible events, uses the method of complex imaginary amplitudes which interfere, and implies a quantum periodicity between  $q$  and  $p$ . Dirac in his *Principles of Quantum Mechanics* has clearly separated Prob-

lem II from III. But he did not attempt to solve the problems, nor did he elaborate on Problem I which is of particular interest to the philosophy of science. Although physicists handle quantum problems with virtuosity in theory and in practice, their ideology and language is still plagued by illogical fictions inherited from the earlier phase of the theory. To mention but one of them: it certainly had been a most paradoxical situation to find that matter sometimes acts as though consisting of particles (in scintillations on fluorescent screens, clicks in Geiger counters, and tracks in cloud chambers), and sometimes appears as waves (in diffraction patterns through crystals). However, when Max Born established his statistical particle interpretation of the Schrodinger wave intensity, the former *duality* has become a contrast of a *substance* (particles) *versus* one *quality* of said substance (an occasional periodic statistical particle distribution in space), that is, an illogical contrast of incontrastibles. With the same logic one could attribute duality to the surface of a lake which, on the one hand, consists of water droplets, on the other hand, displays an occasional wave-like distribution of the same droplets. Instead of accepting this kind of water duality as fundamental one rather will ask for a mechanical explanation of the water waves. And similarly, instead of accepting periodic wave functions  $\psi$  dominated by an action constant  $h$  as fundamental, one will ask the questions II and III above. But let us first attack the Problem I.

## I. DETERMINISM *versus* CHANCE

Every game of chance presents us with an average statistical ratio between possible outcomes, accompanied by fluctuations conforming with mathematical error theory. The adherents of determinism tell us, however, that chance is only an appearance, that in reality each individual outcome, *e.g.*, the result 'head' in a coin-dropping machine is but the final event of a deterministic chain... *hhhh* of head-producing preconditions. However, this argument in favour of a hidden determinacy is *not* an answer to the problem of *statistical co-ordination* of the various causal chains producing those averages and fluctuations. If chance distributions are mere appearances, their deterministic causation might be described as follows.



There was once a *demon* who first started two head chains, then one tail chain, then five head chains; then realizing that he had given too much preference to heads, he started six tail chains in a row, and so forth, in order to produce the *appearance* of random when actually there was individual causation—all this in order to mislead present-day physicists away from the one and only true deterministic faith.

An as-if theory of this kind can hardly be taken seriously, however. The only way out of the dilemma is conceding that determinism fails to explain the harmony between statistical fact and mathematical error theory, the latter being a basic and irreducible feature of the world we live in. This conclusion has finally and reluctantly been drawn by the quantum physicists who are constantly confronted with average ratios *plus* fluctuations over several effects B, B', B'', . . . produced by one cause A, as in Fig. 1a. A reduction to hidden causes A, A', A'', . . . as in Fig. 1b would not help to restore determinism, but only blame present random on past random. In order to arrive at this conclusion one does not need the much-quoted proof of von Neumann, which recently



FIG. 1a

FIG. 1b

has been found to be circular anyway. But the same conclusion applies also to 'ordinary' games of chance; their results are likewise irreducible to a deterministic explanation, as seen before. In the author's opinion, the distinction between ordinary games and kinetic gas theory on the one hand, and quantum fact and theory on the other, has been widely over-rated. It is not true that in ordinary games *we could if we would* remove the element of random. And although the quantum constant  $h$  is of importance for the quantitative calculation of statistical ratios in specific atomic games, it is irrelevant for the general question of whether there is determinism or randomness tempered by statistical law.

## II. CAUSE-EFFECT CONTINUITY

The indisputable failure of the *law of sufficient causation* may be a shock to scientists schooled in the 300-year-old tradition. And, many, among them Planck and Einstein, have pleaded for an eventual return to strict determinism as a necessity under the *law of sufficient reason*. However, although the latter is

indeed a necessity of thought before all experience, only experience followed by critical analysis based on sufficient reason can decide whether the law of sufficient causation is valid. And the results in "games of chance" testify against maintaining the doctrine of determinism, demons not being admitted. Under these circumstances it would be desirable to find *sufficient reasons for the lack of sufficient causation*. This is possible indeed when one accepts another empirical law or postulate, *viz.*, that of *cause-effect continuity*, which invalidates the (wrong) law of sufficient causation. The continuity law was first pronounced explicitly by Leibniz (1648-1716); it reads:

"An infinitely small change of cause never produces a finite change of effect."

As an illustration consider the following game. Balls are dropped from an adjustable chute upon a knife-edge. If the chute is aimed at the right (left) of the knife, all balls will drop to the right (left). Suppose now that the aim is gradually shifted from right to left. Theoretically one might expect that at a certain critical angle  $\alpha$  of aim there will be an abrupt change, from all  $r$ -balls to all  $l$ -balls. The cause-effect continuity postulate, however, when applied to physical balls aimed through a physical chute at a physical knife-edge, requires that there be a finite range  $\Delta\alpha$  of aim within which a gradual change of the  $r:l$  ratio from 100:0 to 0:100 will take place. The only conceivable way of bridging the gap between the two extreme effects is the occurrence of intermediate  $r:l$  ratios. The latter then can only be statistical ratios, *i.e.*, probability ratios for an individual ball. The continuity postulate of cause and effect thus demands that one and the same physical aim  $\alpha$  within a finite range  $\Delta\alpha$  may be followed by two different effects,  $r$  or  $l$ .

The next example<sup>1</sup> is particularly illuminating since it leads straight to the peculiarities of quantum physics. Suppose a given mechanical system (atom) is capable of various 'states' A, B, C, etc. Even without specifying the term 'state', one certainly may ask how two states A and B could possibly be distinguished as different,  $A \neq B$ . The operational answer is: states A and B qualify as different when they can be separated by some kind of 'filter', *i.e.*, by an 'arrangement which responds with *yes* to A and with *no* to B when  $B \neq A$ . Figs. 2a and 2b schematically illustrate the reaction of an A-passing filter to B-state atoms when  $B = A$  and when  $B \neq A$ , written  $B = \text{non-A}$  or  $B = \bar{A}$ . For example, A and B may represent

two different atomic axis directions in space.

Imagine now that the difference between A and B, *c.g.*, the angle between the atomic axes, is gradually made smaller and smaller. Theoretically it may be expected that the A-passing filter will abruptly change its reaction, from blocking to passing B-particles, only in the very last moment when the difference between A and B is changed from, however small to exactly zero. The continuity postulate requires, however, that there be intermediate cases where neither all B's are passed nor all B's are blocked, cases of a 'fractional equality, written  $A \sim B$ , with a reaction as depicted in

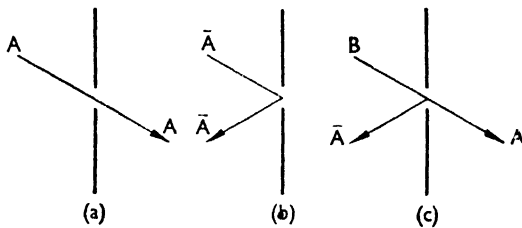

FIG. 2a

FIG. 2b

FIG. 2c

Fig. 2c. The ratio between passed and repelled B-state particles in this *splitting effect* can conceivably be only a statistical ratio; that is, an individual incident B-particle has a certain *probability*  $P(B, A)$  of passing; and probability  $1-P$  of being repelled. The passing fraction  $P(B, A)$  may then be taken as an operational definition of the *fractional equality degree* between A and B. And since equality is mutual, one will not be surprised to find that  $P(A, B) = P(B, A)$ , *i.e.*, that the passing fraction of A-state particles through a B-passing filter equals the passing fraction of B-particles through an A-filter. This *symmetry* of the passing fractions must be counted as a separate assumption, however. The statistical division of incident B-state particles in a test with an A-state passing filter is a direct inference to be drawn from the postulate of cause-effect continuity. We have thus arrived at the typical "splitting effect" of quantum physics as a consequence of the continuity postulate.

### III. REPRODUCIBILITY

In addition to cause-effect *continuity* and *symmetry* let us now introduce the principle of *reproducibility* of a test result: "A particle which has once passed an A-filter will pass an A-filter again" unless something is done to it between the two A-filter tests. Similarly, "once rejected, always rejected". If this principle is empirically true then it implies that those incident B-particles of Fig. 2c which pass the

A-filter, must have acquired the new state A, *i.e.*, must have jumped from state B to A, and those blocked must have jumped from B to non-A =  $\bar{A}$ , and stay in these newly acquired states. The amazing fact of 'quantum jumps' in tests, from B to A and  $\bar{A}$  respectively at a statistical ratio, can thus be seen as a direct implication of the two principles of cause-effect continuity and reproducibility. And the same passing fraction  $P(B, A)$  which was taken above as a quantitative definition of the fractional equality degree between A and B, now acquires the additional meaning of the *transition probability* from B to A in an A-filter test and, remembering the symmetry postulate, from A to B in a B-filter test.

Reproducibility of a state justifies regarding the state as 'objectively possessed' by the particle. On the other hand, a particle cannot possess, *i.e.*, display in a reproducible manner, a combination AB-state; rather, when an A-filter turned the state B to A, a subsequent B-filter test may result in either turning the particle back towards its original state B, or to non-B. This holds in particular for  $A = q =$  position and  $B = p =$  momentum. Each separately defines a reproducible state, but there is no combination  $qp$ -state. This is of utmost importance for the new mechanics. Nevertheless, incompatibility of states as such is an old familiar occurrence. For instance, a viscosity value of a given sample of water and an angle of twist of the same sample when frozen define individually reproducible, objective states, but there are no combination states of viscosity  $v$  and twist  $t$ . This situation certainly does not give rise to a new philosophy of knowledge. We cannot see why the incompatibility of  $q$  and  $p$  should necessitate a new philosophy either.

One more general remark is in order here. At first sight it may seem paradoxical that the continuity postulate should lead to the phenomena of discontinuous jumps. It will be recalled, however, that we did not postulate continuity as such ("natura non facit saltus") but cause-effect continuity. And we saw that this postulate implies the existence of discontinuous processes which are controlled statistically rather than causally.

### IV. THE PROBABILITY METRIC

Students of quantum theory acquainted with the method of complex imaginary quantities  $\psi$  often have the impression that here we are permitted a glimpse into an abstract world of regularities behind the real world of phenomena, with laws more powerful than the

ordinary laws of mechanics. This impression is strengthened when Niels Bohr<sup>2</sup> tells us that "these symbols themselves, as indicated already by the use of imaginary numbers, are not susceptible to pictorial interpretation", and when Heisenberg<sup>3</sup> proclaims that  $\psi$  is "abstract and incomprehensible, . . . so to speak containing no physics at all", quoting only a few utterances about the esoteric quantity  $\psi$ . In order to dispel the aura of incomprehensibility let us first consider the following general situation.

Suppose there is a class of quantities  $\phi$ , each  $\phi$  having two subscripts. There are only two known ways by which one can connect *any* three quantities such as  $\phi_{AB}$ ,  $\phi_{BC}$ ,  $\phi_{AC}$ , in a self-consistent mathematical fashion, *viz.*,

(A) the addition law,  $\phi_{AC} = \phi_{AB} + \phi_{BC}$ , made self-consistent by the condition  $\phi_{AA} = \phi_{AB} + \phi_{BA} = 0$ , and

(B) the multiplication law,  $\psi_{AC} = \psi_{AB} \cdot \psi_{BC}$  made self-consistent by the condition  $\psi_{AA} = \psi_{AB} \cdot \psi_{BA} = 1$ .

The law (B) is only another form of (A) by virtue of  $\psi = e^{\phi}$ .

An example of (A) is furnished by the geometry of lengths  $L$ . However, the quantities  $\phi$  cannot be identified with the lengths  $L$  themselves since  $L_{AA}$  is zero whereas  $L_{AB} + L_{BA} = 2L_{AB}$ . However, one can associate each  $L_{AB}$  with a quantity  $\phi_{AB} = \phi_{BA}$ , *viz.*, with a *vector*  $\phi$  which satisfies the conditions (A):

$$\phi_{AC} = \phi_{AB} + \phi_{BC}, \text{ with } \phi_{AA} = 0. \quad (1)$$

The geometrical vector structure might be in one, two, three or more dimensions. The vector addition law (1) holds for any structural framework between points A, B, C, . . . The direct relation law between the lengths  $L$  themselves, however, differs in the various geometries:

- (a) In structures along a straight line, 4 points A, B, C, D are connected by 6 lengths  $L$ , and 5 of them uniquely determine the sixth.
- (b) In a plane 5 points are connected by 10 lengths  $L$ , and 9 of them uniquely determine the tenth.
- (c) In 3-space 6 points are connected by 15 lengths  $L$ , and 14 of them uniquely determine the fifteenth,

and so forth. In the case of plane geometry (b), vectors can be denoted by complex symbols,  $\phi = Le^{i\alpha}$ , where  $\alpha$  determines the direction. But nobody would declare that, because of this imaginary symbol, vectors are abstract, incomprehensible, or unpictorial. Remember also that geometry thrived for three thousand years without the use of vectors.

The development of the quantum theory has been analogous, though in reverse order. One has discovered first that the probabilities  $P$  are interconnected *via* a kind of triangular law between associated complex quantities  $\psi$  ( $=$  vectors in a plane), a law of the form

$$(\psi_{AC}) = (\psi_{AB}) \cdot (\psi_{BC}) \text{ with } (\psi_{AB}) \cdot (\psi_{BA}) = \quad (2)$$

in which the symbol ( $\psi$ ) stands for a whole group of quantities  $\psi$  arranged in a table or 'matrix'. The vectors  $\psi$  give direction to the probabilities  $P = |\psi|^2$ , so that one has a kind of structural framework of probability vectors in a plane. Afterwards it has turned out that the vector law (2) is equivalent to a direct connection law between the probabilities  $P$  themselves, in close analogy to plane geometry, case (b) above. According to the considerations at the beginning of this section, the relation (2) is the only conceivable self-consistent triangular connection law between probability matrices. It is known to mathematicians as the law of unitary transformation, to physicists as the law of *interference of probabilities*. But if this law is the only self-consistent law conceivable, then it can hardly be described as 'incomprehensible'; in the contrary, it is thereby *explained* as a necessity. In conclusion, the quantum riddle II is solved by reduction to the elementary postulate that the various probabilities of transition do not form a chaos but are dominated by a self-consistent interconnection law at all; the latter can *only* be the law (2).

## V. QUANTUM PERIODICITY

The most baffling enigma of quantum theory is contained in the relations  $E = h\nu$  and  $p = h/\lambda$ , and in the equivalent rules of modern quantum mechanics, *viz.*, Born's  $qp$ -commutation rule and Schrödinger's  $p$ -operator rule. All these rules are condensed in the fact that the probability amplitude of transition between a co-ordinate value  $q$  and a momentum value  $p$  is of the complex imaginary form

$$\psi_{(p,q)} = \exp(2i\pi qp/h), \quad (3)$$

which is indeed periodic in  $q$  with wave-length  $\lambda = h/p$ . The periodicity rules have become so familiar to the physicist that he now considers them as 'fundamental', as offering no problem any more, as being manifestations of equally fundamental and irreducible principles of duality and complementarity. Yet it is possible to deduce the periodic relation between co-ordinates  $q$  and momenta  $p$  from a simple non-quantal background, *viz.*, by requiring:

- (a) Only  $q$ -differences and  $p$ -differences, rather than absolute  $q$ - and  $p$ -values have physical significance,

(b) conjugacy of  $q$  and  $p$  involves a constant statistical density in  $q$ -space for given  $p$ , and a constant statistical density in  $p$ -space for given  $q$ .

Postulate (a) is simply taken over from classical mechanics; it applies to linear, not to angular co-ordinates and momenta. Postulate (b) is likewise familiar from classical statistical mechanics. Neither (a) nor (b) contain any hint of periodicity or quantization: they are of a non-quantal nature. Yet, when combined with the former probability metric (2) which likewise rests on non-quantal foundations, (a) (b) lead by mathematical necessity<sup>1</sup> to the result that the function  $\Psi(q, p)$  must be of the complex exponential form,  $\exp(2i\pi qp/\text{constant})$ . This agrees with (3) when the constant denominator is denoted as  $h$ . Of course, one cannot tell from general considerations how large the constant  $h$  should be in terms of conventional units; one ought to expect it to be small, however, so as to allow classical mechanics as an approximation for macroscopic phenomena. The mathematical derivation of (3) rests on answering the second of the following questions:

Which function is such that  $f(x) \cdot f(y) = f(x + y)$ ?

*Answer.*—The exponential function, since  $e^x \cdot e^y = e^{x+y}$ , which function is such that  $f(x) \times f^*(y) = f(x - y)$ ? (The asterisk indicates the complex conjugate).

*Answer:* The complex exponential function, since  $e^{ix} \cdot e^{-iy} = e^{i(x-y)}$ .

Although the foregoing considerations may be classified as theoretical physics, i.e., reduction of strange phenomena and sophisticated calculation rules to simple empirical postulates, they also have wider implications. In particular they challenge the doctrine of the Copenhagen School that duality and complementarity are 'first principles' necessitating a new philosophy of knowledge with a new language of interpretation. We do not speak here of 'confirmations' of complementarity found in the ideals of love *versus* the ideals of justice, in the eternal female (waves?) *versus* the eternal male (particles?), in the element of complacency inherent in every national culture manifesting itself in prejudices, and similar profundities. We only hope to have shown that quantum physics is not magic, and that its enigmatic rules and principles can be reduced to simple and elementary postulates of a commonsense character.

1. Landé, A., *Foundations of Quantum Theory, a Study in Continuity and Symmetry*, 1955, Yale and Oxford University Press.
2. Bohr, N., *Diadectua*, 1948, 2, 312.
3. Heisenberg, W., *Niels Bohr and the Development of Physics*, 1955, Pergamon Press, London, p. 26.
4. Landé, A., *Am. Journal of Physics*, 1956, 24, 56.

## CONSERVATION OF PARITY LAW TESTED ON FREE NEUTRONS

UNIVERSITY OF CHICAGO and Argonne National Laboratory scientists have announced experiments showing that a basic assumption of physics—the law of conservation of parity—does not hold true in the radioactive decay of the neutron. Tests with cobalt atoms, made earlier this year at the National Bureau of Standards hinted this might be so. In these experiments, electrons were released by decaying neutrons locked in the heart of cobalt nuclei.

The new studies are the first to test the parity law on free neutrons.

The neutron is a fundamental particle found in the nucleus of almost every atom. Like the earth, it spins on an axis, but in either direction. It has no electrical charge, but decays into two electrically charged particles: a positive proton and a negative electron.

According to the disproved parity theory, these electrons and protons are always emit-

ted equally toward either pole in any given number of decaying neutrons. To simplify the experiment, the Argonne-Chicago scientists measured only the distribution of electrons. They found that only about 62% as many electrons came off toward one pole as the other.

The "slow" neutrons for the experiment came from one of 50 openings in the side of Pile-5, an atomic reactor located at the Argonne Laboratories near Lemont, Illinois. Neutrons whose poles pointed the same way, and which spurt in the same direction, were selected from the pile's beam by a magnetic mirror. These identical neutrons were then directed into a vacuum chamber some six feet long and three feet square. On the top side of this long metal box was a device for detecting fast electrons.

Practically all the air inside the chamber had been pumped out so that the neutrons would not accidentally collide with air

molecules and release electrons unrelated to neutron decay. To get statistics on, whether emitted electrons preferred either pole, the scientists needed large numbers of neutron decaying in the chamber. This presented a major difficulty. While neutrons decay, on the average, after 18 minutes existence, even the "slow" 5,000-miles-per-hour neutrons used, travelled through the vacuum chamber in a

hundred-thousandth of a second.

The problem was solved by shooting a steady stream of 70 million neutrons per second through the chamber. This so increased the number of neutrons that happened to decay while passing through, that disintegrations were recorded only seconds apart. (*Jour. Frank. Inst.*, 1957, 264, 442.)

---

## THE INDIAN SOCIETY OF THEORETICAL AND APPLIED MECHANICS.

### THIRD CONGRESS ON THEORETICAL AND APPLIED MECHANICS

**T**HE Third Congress on Theoretical and Applied Mechanics was held at the Indian Institute of Science, Bangalore, from December 24th to December 27, 1957, under the Presidency of Dr. S. R. Sen Gupta, Director, Indian Institute of Technology, Kharagpur. Delegates from Australia, Burma, Czechoslovakia, Egypt, Hungary, Japan, Poland, U.S.A., U.S.S.R., participated in the Congress. Dr. S. Bhagavantam, Director, Indian Institute of Science, Bangalore, welcomed the delegates.

In his Presidential Address, Dr. S. R. Sen Gupta dealt with modern theories of design of frame structures based on plastic failure in rectangular steel and reinforced concrete sections. He explained some of the latest trends in the theory with the help of a number of stress-strain and bending moment diagrams for various load patterns.

Half-hour addresses were delivered by S. Bhagavantam, S. Dhawan, Yoshikatsu Tsuboi, G. K. Mikhailov, A. Ilushin, V. A. Arkhangel'sky, Laszle Jarmai, I. I. Artobolevskiy, P. H. Nelson, E. G. Richardson, Norman Davids and J. Litwinski. Dr. S. Bhagavantam showed that the theory of finite deformation could be used to explain explosions in rocks at great depths, where they are subjected to large stresses and strains. Dr. S. Dhawan discussed the transition from laminar to turbulent flow. He said that the amplified disturbance waves roll up into discrete vortex filaments which themselves undergo distortion until localised spots of turbulence are born in a random fashion. These spots, once created, grow and spread until the whole field is turbulent. Mikhailov reported on the unpublished notes and manuscripts of L. Euler on Theoretical and Applied Mechanics. He also outlined two approximate methods of solution of the problems of non-uniform motion of ground water

along a plane impermeable base. The method of succession of steady states was used by Arkhangel'sky to obtain computations of the movements of multiphase liquids in pipes and through porous media. Jarmai investigated the buckling of a system of beams by means of matrix theory. A contribution to the theory of synthesis of mechanisms for the reproduction of some kinds of Algebraic and Transcendental Curves was put forth by Artobolevsky. P. H. Nelson illustrated visualising mathematical models of microwaves. Norman Davids dwelt upon the penetration of stress waves in plates. An interesting talk on stress-small strain relation in the mechanics of continuous media was given by Prof. Ilushin of the Academy of Sciences, U.S.S.R. Prof. Richardson dealt with acoustic relaxation. J. Litwinski gave a talk on the mathematical basis of the mechanics of stochastic media.

B. R. Seth gave some useful non-linear solutions of the vorticity equation, discussed a general solution of this equation and pointed out its use in classical problems of non-linear rotational flows. P. L. Bhatnagar and S. K. Lakshmana Rao discussed steady motion of non-Newtonian fluids in tubes.

The Congress received 91 original papers, of which 70 were read and discussed. The subjects dealt with included Finite Deformation, Visco-elasticity, Stress Waves, Stresses in Strips, Columns and Discs, Plasticity, Elastoporous Problems, Vibration and Stability, Fluid Flow, Ballistics and Statistics.

Prof. P. L. Bhatnagar was elected as Vice-President and Y. V. G. Acharya, S. Dhawan and P. N. Chatterji were elected new members of the Council.

The Society accepted an invitation to hold the Fourth Congress in December 1958, at Bengal Engineering College, Calcutta.

---

## TRACER ATOMS IN THE STUDY OF PLANT LIFE

ACADEMICIAN A. L. KURSANOV

**T**HE phenomenal advancements in the field of nuclear physics and nuclear energy have exerted a tremendous influence on the development of many branches of science and engineering, and even of such of those which at first glance seem in no way connected with problems of atomic fission. In the present age, machines generating electric current capable of performing all kinds of useful work are set going by atomic energy. With the help of radioactive elements and ionizing radiations many industrial processes are controlled; the geological age of rocks is assessed, the chemical structure of substances is established, processes that take place in the human body and in animal and plant organisms are studied, the nature of organisms is altered and even the historical dates connected with the ancient culture and the development of human society are determined.

But this is only the beginning of a new era. At present it is as yet difficult to foresee all that can be accomplished with the help of radioactive elements. This fully refers to biology, which by no means has exhausted all the possibilities opened by modern nuclear physics. Nevertheless, within a short period of time the utilization of radioactive elements has advanced so far that the outlines of fuller and more precise conceptions of plant's life are becoming clearer.

The application of the tracer atom method has enabled us to differentiate easily substances containing the radioactive or non-radioactive isotope, in any biological environment or even in a whole organism, and to draw conclusions about the normal course of transformations. If their radioactivity is not high, tracer atoms participate in the general metabolism, together with the non-radioactive compounds. In order to illustrate this by concrete examples we shall try to depict plant nutrition in the form we see it now, after several years of application of the tracer method.

It was known long ago, that roots take up from the soil only water and mineral salts and send them up to organs of the plants above the ground which utilize these nutritive substances. The functions of synthesis were, on the whole attributed to the leaves. Roots were regarded chiefly as intermediaries between the soil and the leaves, as organs that fix the plant in the soil and play only a subsidiary role. In some cases they served as a place where organic substances coming in from the leaves may

accumulate. The capacity of the roots themselves to form many complex compounds was usually taken little into consideration.

Scientists even at the beginning of the twentieth century demonstrated that roots are not only transmitters of inorganic substances to the leaves but that they themselves can accomplish the initial transformations of these substances into organic compounds. However, even after this, the role of the roots as an organ actively participating in the general metabolism of the plant continued to be obscure. Leaves were considered, as before, the organs in which not only the initial but also the secondary, more complex organic substances are formed. Thus, the function of assimilation of substances in plants seemed to be concentrated only in the leaves.

Within recent years as a result of the application of the tracer method fresh ideas have been gained in this branch of knowledge. In 1940, the Soviet scientist V. Kuprevich found that carbon dioxide dissolved in water can penetrate through the cut stems of plants to their leaves and be transformed into starch there. Later we found that roots not only consume carbon dioxide from the soil, but send it to the leaves where in the presence of light, the soil carbon dioxide can be utilized for the formation of sugar and other products together with the carbon dioxide taken up from the air. The entire process proceeds so rapidly, that in 5-10 minutes after the contact of the roots with the carbon dioxide solution labelled with radioactive carbon, the tracer atoms are found in all parts of the plant, especially in the leaves. With the help of radioactive carbon the internal mechanism of the phenomenon has been also studied quite in detail. It is well-known that sugar, formed in the leaves from the carbon dioxide taken up from the air, moves down along the plant until it reaches the roots. The rate of this downward movement can be now easily and precisely measured with the help of substances labelled with radioactive elements. It attains 40 and even 100 cm. an hour. As a result the products of the majority of farm plants in the process of photosynthesis reach the roots in 30-40 minutes. In the young roots which are capable of actively uptaking nutritive substances from the soil, sugar is decomposed, as a result of which pyruvic acid is formed. This acid is capable of taking up soil carbon dioxide and being converted into oxalic-acetic and malic acids. These acids are precisely

the first stable compounds which carry in one of their groups carbon dioxide taken up from the soil. As a result of the mutual transformation of organic acids the soil carbon dioxide may enter into the composition of other acids.

However, it should be kept in mind that such an uptake of carbon dioxide in organic substances cannot as yet be regarded as the nutrition of plants because, the free energy of these compounds remains practically the same. However, with the help of radioactive isotopes it was established that organic acids do not remain in the roots but rise to the leaves. Together with them carbon dioxide also very rapidly reaches the green tissues. Here, it can once again be released and in the process of photosynthesis form carbohydrates, proteins and other highly caloric products. The possibility of utilizing carbon dioxide which is released from other organic acids has recently been proved by the French research worker Mauise and the Soviet scientist V. Soldatenkov.

A part of the sugar formed in this way in the leaves is once again sent down to the roots. There it is transformed into pyruvic acid and takes up new portions of carbon dioxide, which it brings to the leaves. This is a peculiar fundamental process in which the work of the roots and the leaves is inseparable. Thus, with the help of labelled carbon a new means of the inclusion of carbon dioxide in plant metabolism has been disclosed. By supplying roots with the necessary amount of carbon dioxide a favourable influence may be exerted on crop yields. Experiments conducted in recent years have shown that the manuring of the soil with ammonium carbonate (instead of ammonium sulfate) or other means of enriching it with carbon dioxide increases yields of sugar beet, spring wheat, corn and cotton by 10-15%. Elucidation of the capacity of roots to assimilate carbon dioxide is important because it discloses more fully the role of organic manures and soil micro-organisms in meeting the requirements of roots in carbon dioxide.

By observing with the help of labelled carbon the movement of organic acids from the roots to the leaves, we become convinced that a certain amount of soil carbon dioxide bound up with organic acids is broken off and utilized by the green cells of the stem usually grouped along the vascular bundles of the plants. As a result in the compact bast tissues, inaccessible to air from without, a large amount of oxygen appears necessary for the active respiration of these tissues. In order

to show how great is the significance of oxygen respiration of the conducting cells for the movement of organic substances in plants, the results of our experiments conducted with radioactive carbon may be cited. The data obtained from these experiments have shown that inhibition of oxygen respiration in the conducting tissues by carbon monoxide stopped the movement of sugar and other organic substances. In this way the role of chlorophyll-bearing cells which always accompany the conducting tissues was disclosed.

The uptake of carbon dioxide from the soil is directly connected with such a function as the nitrogen and phosphorus nutrition of the plants. This is evidently the most important factor in the process of assimilation of soil carbon dioxide by the plant. It has been recently found that many amino-acids from which proteins are formed are synthesized in the roots. Besides that, it has been established that plant roots form alantoin, cytulline and certain other more complex nitrogenous compounds. Therefore, besides the function of absorption the root system fulfils another important role connected with the protein metabolism of the whole plant.

At first it seemed as though this aspect of the root's activity was an independent function not connected with their absorbing capacity. However, with the help of tracer atoms it was disclosed, that this precisely is the direct mechanism of the assimilation of ammonium fertilizers from the soil by the roots.

The application of the tracer method in the field of biology gives ground, to state, that today the old conception that roots play only the modest role of mere transmitters of mineral substances and water to above-ground organs must be rejected. In the light of new scientific data, roots play a leading role in the complex transformations of substances which take place in plants. If a leaf is placed without severing it from the plant for a few minutes in a glass chamber containing radioactive carbon dioxide and illuminated, radioactive sugars and other products of photosynthesis are immediately formed in the leaf-tissues. With the help of special apparatus, one can follow the direction and rate of movement of the assimilated products.

Today many difficult problems of agrotechnics are being solved with the help of radioactive elements and more effective possibilities of applying fertilizers are being opened, which helps boost farm crop yields.

CHEMICAL CONTROL OF THE RICE STEM-BORER (*SCHOENOBIOUS INCERTULAS* WLK.)

D. V. MURTHY\* AND M. Q. KHAN

Division of Entomology, Dept. of Agriculture, Hyderabad-Dn.

INTRODUCTION

**S**ATISFACTORY control of the rice stem-borer (*Schœnobius incertulas* Wlk.) has been a problem in all rice-growing countries wherever it occurs as a pest. As expressed by Narayanan<sup>1</sup> its control has been one of the most baffling problems in Applied Entomology.

*Dichloro-Diphenyl-Trichloro-ethane* (DDT) and *Benzene Hexachloride* (BHC).—The advent of synthetic organic insecticides opened up a new vista in the control of cereal stalk-borers. Santhanaraman<sup>2</sup> carried out trials with DDT, BHC, HETP and Parathion against *S. incertulas* in Madras State and found that incidence of stem-borer was found to be the least in crop treated with BHC 0.1%. It has been reported from Japan<sup>3</sup> that application of 0.1% DDT emulsion, 0.05% BHC suspension or 1.0% BHC dust is recommended, first application made 3 weeks after seedlings are planted and thereafter 3-5 applications at intervals of 5 days. Padwick<sup>4</sup> also reports that two applications of 1% and 3% Gamma-BHC dusts applied at 36-45 lb. per acre are quite popular in Japan. Matsuo<sup>5</sup> mentions that 1/800 solution of nicotine sulphate and 0.05% DDT emulsion are used against both *S. incertulas* and *Chilo simplex* Butl. in parts of Japan. In Mysore State Puttarudriah and Appanna<sup>6</sup> have found both DDT and BHC equally effective and mention that the above insecticides have a toxic value on the borer larvæ inside the tissue in young plants. Ananthanarayanan *et al.*<sup>7</sup> have found 0.1% BHC spray applied twice or thrice at proper time is useful.

*Organo-Phosphorus Insecticides*.—With the coming in of organo-phosphorus insecticides much attention has been devoted to testing of their efficiency against *S. incertulas*. Iyatomi<sup>8</sup> reported first that 0.05% and 0.1% spray and 0.1% dust of Folidol E.605 would be completely effective against all stages of the rice stem-borer larvæ. In 1954, it was reported by Israel and Vedamoorthy<sup>9</sup> in Cuttack that irrigation of rice plots with Folidol E.605 would give an almost complete control of *S. incertulas* incidence. Rice crop treated thus is said to appear to absorb the active ingredient of Folidol E.605\*

into their tissues and thus develop resistance to stem-borer attack. But, as rightly observed by Ananthanarayanan *et al.*,<sup>7</sup> irrigation of rice plots with insecticides is not a practicable measure of control. Israel and Seshagiri Rao<sup>10</sup> have also found that female *Schœnobius* moths never lay eggs for 5-6 days in crop treated with 0.1% Folidol E.605. In Mysore State Puttarudriah and Appanna<sup>11</sup> have found that 3 to 4 sprays of Folidol E.605 at 0.025% synchronising with the emergence of the moths and large-scale egg deposition will give adequate protection against *S. incertulas*. Ananthanarayanan *et al.*<sup>6</sup> also have found that between Folidol E.605 and BHC sprays against the rice stem-borer, the former is better. In Taiwan<sup>12</sup> it has been found that Folidol E.605 when applied in dilution of 1/2,000 at 200 gallons per hectare before the borer larvæ reach third instar is very effective. Of late, according to Ou,<sup>17</sup> endrin, diazinon and gusathion are also being recommended. Amongst the systemic insecticides tested against *S. incertulas*, Banerji and Basu<sup>13</sup> have reported of preliminary trials with 'Tetrax-1' containing technical Schradan. Probably because the stem-borer incidence was too low it was not possible for the authors to determine whether or not the insecticide exercised any appreciable control, but the treatments did give rise to a high yield of rice largely due to an increase in the number of ears per plant. Preliminary field trials carried out by the authors<sup>14</sup> at the Government Agricultural Research Station, Rudrur, in Andhra Pradesh with "Metasystox" 0.1% have shown that even a single application of spray at the time of emergence of "Flag-leaf" in rice crop is effective against both the adult and larval stages of *S. incertulas*, Folidol E.605 spray and Endrin 19.5% emulsion spray following next in order of effectiveness.

*Cyclodiene Insecticides*.—Endrin is another potent insecticide, which has been widely used against *S. incertulas*. Puttarudriah and Appanna<sup>6</sup> mention it equally effective against *S. incertulas* in young plant along with Folidol E.605, Chlorothion and others. Sengupta and Rout<sup>15</sup> have found in Orissa that a 19.5% emulsion of Endrin applied to rice twice at 0.38 lb., actual Endrin per acre gives good protection against the stem-borer but point out that correct timing of applications is important.

\* Present address: Department of Agriculture, Bangalore.



*Co-ordinated Trials.*—Early in 1955, the Indian Council of Agricultural Research, New Delhi, sanctioned a co-ordinated scheme for the study and control of rice stem-borer in the States of Hyderabad, Andhra, Madras and West Bengal with a common technical programme designed to obtain information on both the fundamental and applied aspects of stem-borer problems. Only two insecticides have been included for trials, namely, Parathion and Endrin. Trials are still under way but indications available show that 0.025% Folidol E.605 is both economical and effective in West Bengal and Madras. In Andhra State, Parathion has been found superior in monsoon crop while in summer season Endrin appears to be more effective. Endrin is also said to induce plant growth and earliness in flowering. In Hyderabad, both Folidol E.605 and Endrin are found to reduce the incidence of borer attack but in view of a higher incidence of stem-borer attack on the second seasonal crop of paddy, no insecticides tested so far have given indication of a satisfactory economical control.

*Some Basic Factors concerning S. incertulas Control.*—It would certainly bear repetition if some basic factors concerning the chemical control of *S. incertulas* is made.

Timing of insecticidal application is the paramount factor in *S. incertulas* control. A comprehensive knowledge of broods, periods of moth flight, egg deposition, incubation period and the time taken for freshly hatched larvæ to bore into the stem in every locality is essential. Mention must be made of an interesting preliminary contribution made by Kao wen-pin *et al.*<sup>16</sup> in China on this aspect of the problem. They have reported that in the second crop season, the first application of the insecticides may be made 7-10 days after the highest period of emergence of third generation moth and that it is necessary to apply insecticides 2-3 times in two weeks which could kill 83% or more of the freshly hatched larvæ. Generally speaking insecticides should be applied as soon as "dead-hearts" in the field exceed 1%. A detailed investigation of the above factors make application of insecticides not only effective and economical but also lifts it above empirical methods of application.

Insecticidal applications, with exceptions have proved ineffective against the larvæ after they get inside the stem. Work done so far

mainly relate to the control of larvæ and not on the other stages of the insect pest. As referred to already, Israel and Seshagiri Rao<sup>10</sup> have shown that female *Schænobius* moth never lays eggs for 5-6 days in crop treated with Folidol E.605. This aspect of control needs further study.

Application of ovicides in the control of *S. incertulas* is also never properly explored. DNOC is a good ovicide. Some exploratory trials carried out by the authors<sup>14</sup> have shown that vegetable oil emulsions from sesame and groundnut have appreciable ovidical properties, when applied to the ova of *S. incertulas*. This line of work also needs study.

This note may perhaps be concluded with the observation that in the control of *S. incertulas* Wlk., chemical control to be effective should be used in conjunction with other known methods of control—particularly ecological methods.

1. Narayanan, F. S., *Ind. Fmg.*, 1953, 3(5), 8-13.
2. Santhanaraman, T., *Pl. Prot. Bull.*, New Delhi, 1952, 4, 4.
3. Anon, *Insects and Diseases of Rice Plant in Japan*, 1954, National Institute of Agri. Sciences, Tokyo, Japan.
4. Padwick, G. W., *Outlook on Agriculture*, 1956, 1, 20-23.
5. Matsuo, T., *Rice Culture in Japan*. Ministry for Agriculture and Forestry, Japan, 1954, 109.
6. Puttarudri h. M and Appanna, M., *Mys. Agr. J.*, 1956, 24 (1), 4-9.
7. Ananthanarayanan, K. P., Nagaraja Rao, K. R., Santhanaraman, T. and Nagarajan, L. R., *Sci. & Cult.*, 1955, 20 (11), 551-53.
8. Iyatomi, K., *Preliminary Experiments of Systemic Insecticides against the Rice Stem-Borer*, Shizuoka Agricultural Exptl. Station, Japan, 1952.
9. Israel, P. and Vedamoorthy, G., *Curr. Sci.*, 1954, 23 (7), 211-12.
10. — and Seshagiri Rao, Y., *Rice News Letter*, (ICAR), 1955, 3, 1.
11. Puttarudriah, M and Appanna, M., *Häfchen Briefe*, 1955, 8 (4), 169-76.
12. Anon, *Draft Report of the 5th Meeting of the Working Party on Rice Breeding, Tokyo, Japan, Int. f. Rice Commission (F.A.O.)*, 1954.
13. Banerji S. N and Basu, A. C., *Bull. Ent. Res.*, 1957, 48 (2) 299-303.
14. Khan, M. Q. and Murthy, D. V. (under publication).
15. Sengupta, G. C. and Rout, G. D., *J. Econ. Ent.*, 1957, 50 (2), 221.
16. Kao wen-pin, Wang Yen-min and Tsiang Tang-Ying, *Acta Entomologica Sinica*, 1957, 7 (3), 353 (in Chinese with English summary).
17. Ou, S. H. *Int. Rice Commission News Letter*, 1957, 6 (3), 19-26.

## THE BRITISH ASSOCIATION FOR THE ADVANCEMENT OF SCIENCE

**S**IR ALEXANDER FLECK, K.B.E., F.R.S., was installed as the President of the Association for 1958. In his inaugural address to the Association he touched upon some of the active aspects of science wherein definite progress was recorded in 1957, and that similar progress might well take place during 1958. He said:

"1957 is strongly associated in the minds of many followers of science with the beginning of the International Geophysical Year, and it is therefore appropriate that I should refer in my opening remarks to the geophysical events which have taken place during the last year. The advancement of technology has probably never been so clearly demonstrated to the whole world as when the first artificial Earth Satellite was successfully launched from Russian soil early in October."

"This event, closely followed by the launching of 'Sputnik II', dominates the I.G.Y., and is the first experiment of a type which will undoubtedly add to man's knowledge of space much that our atmosphere has prevented us from discovering before."

"There is one science in which the British contribution to the I.G.Y. has been of paramount importance during 1957, and that is radio astronomy. At Jodrell Bank Professor Lovell has been obtaining the first results from the largest steerable pencil-beam type of radio-telescope in the world; its adaptability was demonstrated by the way in which it was improvised to detect echoes from the Russian satellites, which it very successfully tracked. Recently it has been trained on more distant sources, and its use will undoubtedly add much to our knowledge of inter-stellar gas, radio-stars and solar flares. In this connection, a special tribute is due to the Sun, whose contribution to the I.G.Y. has been a vastly great output of sun-spot activity."

"The other notable British achievement in radio-astronomical research has been the construction of the new interferometers at Cambridge. One of these instruments is intended primarily for the study of radio-stars and another will be used to investigate continuous radiation from our Galaxy. By these techniques, Dr. Ryle hopes to penetrate further into the outer reaches of the Universe than ever before, and thus to throw more light on one of the central controversies of cosmology, whether we live in an 'evolutionary' or 'steady-state' Universe."

### NUCLEAR AND THEORETICAL PHYSICS

"It is probably in the field of nuclear and theoretical physics that the next most significant advances have been made. The award of the Nobel Prize for Physics to Yang and Lee has called public attention to the law of conservation of parity, the universality of which was disproved early last year at the National Bureau of Standards in Washington and at Columbia University. Parity is concerned with the kinematics of groups of fundamental particles, and its conservation in nuclear transformations was assumed until rather more than a year ago. I merely point to the importance of constantly questioning the validity of our beliefs concerning natural phenomena, even when they have sufficient respectability to be called 'laws'. However, I must tread very delicately over these and similar provinces of the specialist."

"The discovery of the 102nd element, nobelium, is another announcement made during 1957. It is the first man-made element to be discovered in Europe, and it provides another instance of international teamwork in scientific research, for British, Swedish and American scientists all participated."

"The method of preparation was to bombard curium-244 with nuclei of carbon-13, which were accelerated in the 225-cm. cyclotron in Stockholm. Since the half-life of the resulting isotope was only about ten minutes, considerable ingenuity was required to identify it. Those of us who are chemists will be particularly interested in the properties of any new elements that are discovered, for we may soon find ourselves exploring a new period in the Periodic Table."

"Several significant events have occurred in this country during 1957 which relate to the production of energy."

"Of far-reaching significance is the brief announcement that Dr. Thonemann's team at Harwell have apparently succeeded in conducting a controlled thermonuclear fusion in their quartz torus known as 'Zeta' II. This type of reaction provides the energy of a hydrogen-bomb explosion, and of the Sun, and if it can be made self-sustaining in the laboratory, it is likely to have a major effect on power production later in this century. The energy put into the Harwell apparatus was concentrated by electric and magnetic fields so as to produce a temperature of the order of 5 million degrees

Centigrade, and it has been calculated that a ten- to twenty-fold increase would probably be required before nuclear fusion would be self-sustaining. As conducted, the experiment gave detectable quantities of neutrons, which are believed to have been formed as a result of the fusion of some of the deuterium atoms, which the apparatus contained. This is a piece of pioneer work, the implications of which we can now only see dimly; but in the life-time of some of us we may see them face to face."

#### CHEMISTRY

"In considering the production of energy, I should also mention the development of chemical rocket fuels. Here the requirement is a stable material which will burn evenly to provide a large amount of energy per unit volume or weight. Of course, the military implications of advances in this field make them more the subject of speculation than of informed comment, but it has been announced that plants are being constructed in the U.S. to produce boron compounds for this purpose. The boron hydrides which, with fluorine, fulfil the requirements of rocket fuel, are thus gaining importance for reasons other than their enigmatic chemical structure, in which the boron atoms appear to be tetravalent instead of trivalent. It is a matter for conjecture whether the Sputnik rockets were powered by fuel of this sort."

"Before leaving the field of inorganic chemistry, I ought allude to the production of synthetic diamonds by General Electric in America. Whilst previous claims to have synthesised diamonds have been made, no large industrial undertaking has so successfully devoted research

to the project, nor has the development of a commercial process become so far advanced as in 1957."

"In other fields of chemistry, developments during 1957 have been mainly concerned with the continuation of long-term researches, and it would be inappropriate to single out particular discoveries from each developing subject. One such research programme is the study of nucleotides which is proceeding at Cambridge under the direction of Sir Alexander Todd. His work has this year been honourably recognised by the award to him of the Nobel Prize for Chemistry."

"Also in the biochemical field, perhaps I may be forgiven for alluding to the progress which Dr. Brian and Mr. Grove and their colleagues have made during the last year within I.C.I. Theirs is one of the few British teams working on the plant growth-promoting substances gibberellic acid and related compounds. These materials, hitherto only isolated from a fungus, have produced spectacular increases in the height and weight of several plants such as wheat and peas, as well as inducing premature flowering in biennials. Unpublished work in the Akers Research Laboratories has culminated in the isolation of Gibberellin A<sub>1</sub>, a derivative of gibberellic acid, from runner-bean seeds; and since the gibberellins and the auxins have been shown to be physiologically interdependent, it now appears that there exists in plants a hormone balance such as is well known to occur in the animal kingdom. Final confirmation of the chemical structures of these new hormones will be awaited with considerable interest."

---

### CONTROLLED RELEASE OF THERMONUCLEAR ENERGY

**T**WENTY-FIVE years ago it was discovered in the Cavendish Laboratory that nuclei of heavy hydrogen speeded up by high voltage could join with or fuse together with other nuclei of heavy hydrogen to form helium of mass three, producing neutrons and energy in the process. It is known that processes of this kind provide the energy and heat of the stars. Our sun has a central temperature of about 15 million degrees and at this temperature, nuclei of light elements can move about so fast that fusion reactions can occur.

It has long been the ambition of scientists to produce in the laboratory temperatures so high that useful energy can be produced from fusion reactors.

Research work has been in progress for some years to investigate the possibility of produc-

ing energy in a controlled manner from thermonuclear reactions at Harwell. Two years ago design of a large installation for this work began and in August 1957 the apparatus which is called ZETA (for zero-energy thermonuclear assembly) started up. The reaction being studied in ZETA is that in which deuterons (nuclei of the heavy hydrogen isotope deuterium) collide with one another and fuse to form heavier nuclei, releasing energy and some neutrons in the process. For fusion to be possible the deuterons must have enough energy to overcome the initial electrical forces of repulsion between them; this necessitates heating the deuterium gas to temperatures of millions of degrees centigrade. The hot gas must be kept away from the walls of the container otherwise it falls in temperature.

The principle adopted in ZETA is to pass a large electric current through the deuterium gas. This current sets up an electric discharge in the gas (analogous to the discharge in a neon advertising sign) which heats it and also produces an intense magnetic field around the column of hot gas. This magnetic field causes the discharge to become constricted and hence get heated still more. Since it also causes the discharge to wriggle about, this field by itself is not enough to keep the discharge away from the walls. The wriggling has been suppressed by applying an additional steady magnetic field parallel to the axis of the tube.

In ZETA the discharge chamber is a ring-shaped aluminium tube or torus of 1 metre bore and 3 metres mean diameter, containing deuterium gas at low pressure. The tube is linked (i.e., encircled over part of its length) by the iron core of a large pulse transformer. A current pulse of electricity is passed into the primary winding of the transformer from a bank of capacitors capable of storing 500,000 joules of energy. This pulse in turn induces a very large unidirectional pulse of current in the gas, which forms a short-circuited secondary for the transformer. Peak currents up to 200,000 amperes have been passed through the ionised gas for periods up to 5 milliseconds. The current pulse is repeated every 10 seconds. Emission of neutrons throughout the current pulse is observed regularly in routine operation of ZETA with deuterium; there are up to 3 million neutrons emitted per pulse.

The temperature of gas discharges may be determined from measurements on the light emitted by the gas atoms but measurements of this kind in these experiments present problems because, at the temperature of the discharge, the hot deuterium atoms are completely stripped of their electrons and therefore do not emit a line spectrum. One method of solving this problem is to mix with the deuterium a small quantity of some heavier gas, such as oxygen or nitrogen, the atoms of which are not stripped of all their electrons under these condi-

tions, and to study the spectral lines emitted by this impurity; the random motion of the high energy impurity atoms which make many collisions with the deuterium atoms and so reach the same energy causes the spectral lines to broaden, owing to the Doppler effect, and the amount of broadening is a measure of the ion energy. Many measurements by this method have indicated temperatures in the region of 2 to 5 million degrees centigrade. Whilst temperatures in this range are required to explain the observed rate of neutron production on the basis of a thermonuclear process, electric fields in the gas arising from instabilities, can also accelerate deuterium ions and lead to nuclear reactions. Such a process was described by Academician Kurchatov in his lecture at Harwell in 1956.\* Experiments are continuing to study the details of the neutrons producing processes.

In order to obtain a net gain in energy from the reaction it would be necessary to heat deuterium gas to temperatures in the region of 100 million degrees centigrade, and to maintain it at this temperature long enough for the nuclear energy released to exceed the energy needed to heat the fuel and lost by radiation. Lower temperatures would suffice for a deuterium-tritium mixture. The high temperatures achieved in ZETA, and the relatively long duration for which the hot gas has been isolated from the tube walls are the most important experimental results obtained so far. Whilst, a much longer time (perhaps several seconds) is required for a useful power output, there appears to be no fundamental reason why these longer times, together with much higher temperatures, cannot be achieved. There are, however, many major problems still to be solved before its practical application can be seriously considered and the work must be expected to remain in the research stage for many years yet.

\* Therefore it is not altogether certain that the observed neutrons come from a thermonuclear reaction.

### FIRE-PROOFING OF JUTE.

**A** NEW permanent fire-proofing treatment for jute fabric has been developed by the British Jute Trade Research Association in its Dundee Laboratories. A patent (B.P. 785, 610), has been filed by the Association. The process consists of treating the fabric with a water dispersion containing antimony orthophosphate and a chlorine-containing vinyl plastic resin.

Fabric treated in this is claimed to be resistant to flaming and to afterglow. It is stressed that the fire-proofing is permanent, being retained even after the treated cloth has been weathered outdoors and immersed in sea-water for a considerable period. It also improves the cloth's resistance to abrasion.

## LETTERS TO THE EDITOR

TEMPERATURE DEPENDENCE OF  
ULTRASONIC ABSORPTION IN  $MnSO_4$   
SOLUTION

TEMPERATURE dependence of ultrasonic absorption in  $CoSO_4$ ,  $MgSO_4$  and  $NiSO_4$  has been studied by Kurtze and Tamm.<sup>1</sup> The relaxation frequency is found to be shifted towards high frequency with increase in temperature, the amount of maximum absorption remaining unchanged. The activation energy as calculated by Kurtze and Tamm, from the shift of the relaxation frequency in the particular case of  $MgSO_4$  is 6.5 K.Cal./mole. Wilson's results are somewhat higher than this. In  $NiSO_4$  and  $CoSO_4$ , the experimental activation energies are 8.6 K.Cal./mole and about 6.0 K.Cal./mole respectively. Carstensen has also studied the shift of the relaxation frequency with temperature in  $MnSO_4$ . The temperatures at which he worked are 9.5° C., 18.6° C. and 35° C.

In the present investigation, temperature dependence of the absorption has been investigated at .1M in  $MnSO_4$  solution by the optical diffraction method. With the increase in temperature the relaxation curve is shifted to higher frequencies. Fig. 1 shows the graph

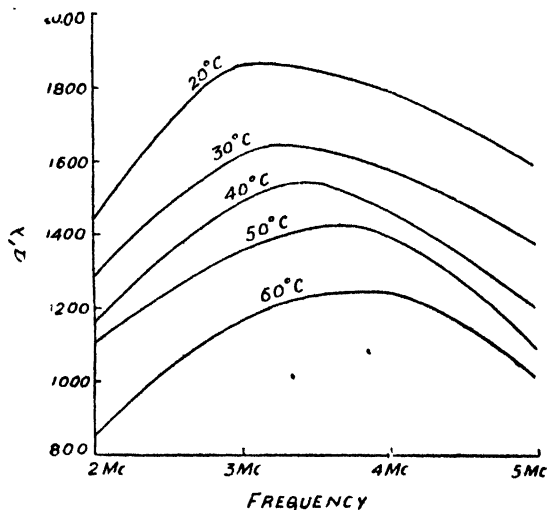

FIG. 1

$\alpha \lambda \times 10^6$  (excess sound absorption  $\times$  wavelength) vs. frequency at different temperatures. The relaxation frequency is given approximately by the equation

$$1/\tau = K_1 + K_2 \approx \frac{KT}{h} e^{-\Delta E/RT}$$

where  $\Delta E$  represents the activation energy. Thus if  $\log (\nu m/T)$  is plotted against  $1/T$ , the graph is a straight line and the activation energy can be calculated from the slope of the curve. Plot of  $\log (\nu m/T)$  vs.  $1/T$  is as shown in Fig. 2. The activation energy as calculated from the slope is 0.8 K.Cal./mole.

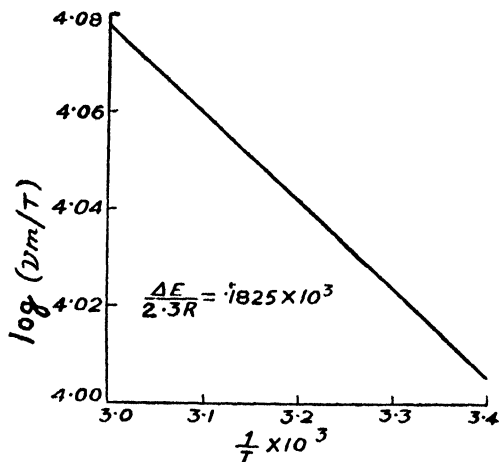

FIG. 2

*Acknowledgement.*—The author wishes to express his sincere thanks to Dr. G. S. Verma, under whose guidance the present investigations were carried out. The author is also grateful to C.S.I.R. for the financial grant.

Dept. of Physics, SUSHIL KUMAR KOR.  
University of Allahabad,  
Allahabad, November 22, 1957.

1. Tamm, K. and Kurtze, G., *Acustica*, 1953, 3, 33.
2. Wilson Jr, B., *Technical Report No. 4, U.C.L.A.*, 1951.
3. Carstensen, E. L., *J. Acoust. Soc. Amer.*, 1954, 26, 862.

STUDY ON THE SEPARATION OF  
THORIUM AND URANIUM (VI) BY ION-  
EXCHANGE

CONSIDERING the importance of thorium as a breeding element for the production of fissionable materials for use as nuclear fuels, several attempts have been made to separate thorium from uranium by different methods. Ion-exchange separation is one of the most important methods amongst them. Seaborg and his collaborators (*J. Amer. Chem. Soc.*, 1954, 76, 1461) studied the adsorption of these elements on a

cation exchanger. Attempts were made here to separate U(VI) and Th(IV) by anion exchange in hydrochloric acid medium. During the course of the work, it was noticed that Kraus and others (*J. Amer. Chem. Soc.*, 1956, 78, 2692) in their investigation on the separation of U(IV), Th(IV) and Pa indicated the separation of Th(IV) and U(VI) in 10 N hydrochloric acid media. The anion exchange behaviour of Th(IV) and U(VI) in hydrochloric acid using Amberlite IRA-400 as investigated here is given below.

Separation of U(VI) and Th(IV) elements is based on the observation that U(VI) can be adsorbed at high HCl concentrations whereas Th(IV) is not adsorbed. For this purpose different experiments were performed to study the adsorption of U(VI) and Th(IV) using hydrochloric acid of various concentrations.

EXPERIMENTAL

Amberlite IRA-400 resin was used for all experiments. The column was first regenerated by passing 200 c.c. of HCl. An artificial mixture containing nearly equal amounts of  $U_3O_8$  and  $ThO_2$  in hydrochloric acid solution was then passed through the column at the rate of 60 drops/min. Effluent was tested for U(VI) and Th(IV).

Adsorption of U(VI) and Th(IV) in various concentrations of hydrochloric acid was first studied with 5 g. column of Amberlite IRA-400 resin. Experimental results showed that U(VI) shows negligible adsorption below 4 N HCl and an increase in adsorption with higher concentrations of HCl. At 6 N HCl, practically all thorium was unadsorbed while 95% uranium was adsorbed on the column.

In order to improve the adsorption of U(VI) at 6 N HCl concentration, a longer column of 10 g. resin was used. It was observed that on 10 g. column of Amberlite IRA-400 resin, U(VI) is all adsorbed at 6 N HCl concentration while Th(IV) is not adsorbed. The effluent was collected and Th(IV) was estimated gravimetrically. The adsorbed U(VI) was then recovered by passing 0.5 N HCl. Results are given below:

Resin—10 g. Amberlite IRA-400  
 $ThO_2$  in HCl = 0.0426 g.  
 $U_3O_8$  in HCl = 0.045 g.

Conc. of HCl	$ThO_2$ unadsorbed	$ThO_2$ adsorbed	$U_3O_8$ adsorbed	$U_3O_8$ unadsorbed
	g.	g.	g.	g.
4N	0.0358	0.0068	0.0362	0.0088
5N	0.0374	0.0053	0.0395	0.0054
6N	0.0426	..	0.045	..
7N	0.0425	..	0.045	..

From the table it is found that complete separation of Th(IV) and U(VI) takes place even at an acid concentration as low as 6 N HCl.

The authors' thanks are due to Dr. Jagdish Shankar for his keen interest during the course of the investigation.

Chemistry Division, (Mrs.) N. S. KUNTE.  
 Atomic Energy D. SEN.  
 Establishment, Trombay,  
 Bombay-28, January 2, 1958.

MEASUREMENT OF ELECTRICAL RESISTIVITY BY THE BALLISTIC METHOD

In a recent communication<sup>1</sup> it was shown that the electrical resistivities of conductors could be measured by the method of inducing a momentary electromotive force in a plane ring of the conductor suitably suspended in a homogeneous magnetic field and observing the resultant ballistic throw. In this technique the specimen is suspended from a torsion fibre in a horizontal field such that the plane of the ring which is vertical, makes an angle of 45° with the field. If the field is switched off in an interval of time very small compared with the time period of the suspension, the ballistic throw  $\theta_1$  is given by

$$\theta_1 = \frac{aA^2 \cdot T \cdot H^2}{8\pi I \rho} \quad (1)$$

in which H is the magnetic field, I the moment of inertia of the suspension, T its time period and A the mean area of the ring, a the area of its cross-section, l its circumference and  $\rho$  the resistivity of the material.

This method has now been extended for specimens in the form of thin circular discs, since they can be made with greater ease. A disc is here considered to be composed of a large number of concentric rings; the integrated ballistic throw  $\theta_2$  is then given by

$$\theta_2 = \frac{\delta \cdot R^4 \cdot T \cdot H^2}{64 I \cdot \rho} \quad (2)$$

where  $\delta$  is the thickness of the disc and R its radius.

The relations (1) and (2) have been used to measure the resistivities of different metals. In these measurements the iron-core electromagnet, used in the earlier experiments, was replaced by a coreless electromagnet having a relatively smaller decay-time for the field.

The mean value of  $\rho$  at room temperature,  $1.765 \times 10^{-6}$  ohms cm.; obtained from measure-

ments on nine discs made from a particular sample of copper, is found to be in good agreement with the value,  $1.761 \times 10^{-6}$  ohm cm., obtained from four rings made out of the same sample of copper. All these specimens were annealed before measurements. The results obtained with specimens of other metals are also satisfactory.

It is observed that the 'reproducibility of the results is of the order of one per cent.

National Physical K. G. RAMANATHAN.

Lab. of India, J. S. DHILLON.

New Delhi-12, K. D. BAVEJA.

January 3, 1958.

1. Ramanathan, K. G. and Dhillon, J. S., *J. Sci. Industr. Res.*, 1956, **15B**, No. 5, pp. 213-16.

### ZIRCONS FROM GRANITES OF MYSORE

ZIRCONS from typical coarse-grained granites of Nandi, Chamundi, Banavar, Holalkere and Closepet are studied to bring out similarities, if any, in them. They are classified according to colour, habit, elongation and size. Majority of them have simple terminations and are normal-prismatic, colourless to brown with persistent zoning. The elongation ratio, in zircons, lie between 2 and 3. The size of zircons, in

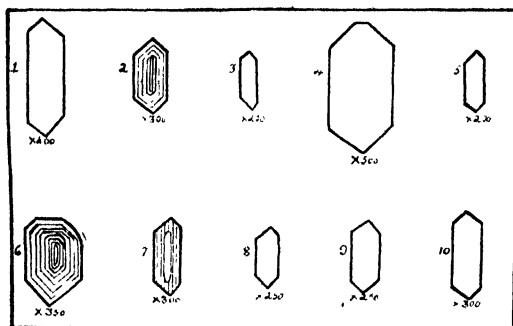

Original Reduced to  $\frac{1}{8}$ .

- Nos. : 1-2 Nandi Granite (No. 2. Zoned)  
3 Chamundi Granite  
4-6 Banavar Granite (No. 6. Zoned)  
7-8 Holalkere Granite (No. 7. Zoned)  
9-10 Closepet Granite

majority of crystals measured, indicate a uniform length of .02 mm. and breadth of .01 mm. The following table illustrates the elongation and size frequency of zircons in different granites.

Granites	No. of zircons measured	Elongation Ratio			Size	
		1	2	3 and more	I. Maxima .02 mm. %	B. Max. .01 mm. %
Nandi	65	2	27	36	55	50
Closepet	70	4	29	37	57	78
Holalkere	22	1	13	8	54	50
Banavar	16	2	14	0	70	65
Chamundi	16	0	11	5	75	60

The similarity in habit, colour and size of zircons suggests a uniformity in granites. Besides the elongation, range in size and zoning in some zircons are characteristic of igneous granites.

The uniformity of character noticed from the zircons of granites from different parts of Mysore suggest that the granitic bodies may be of common igneous origin. The similarity of character would not have been so persistent if the granites were due to transformation of some other rocks.

A detailed paper on study of zircons and the modal analyses of granites from Mysore State will appear elsewhere.

The author is greatly indebted to Prof. M. R. Srinivasa Rao, Professor of Geology, Central College, Bangalore, for suggesting the problem and for guidance throughout the preparation of this work.

Dept. of Geology,

A. ACHUTA RAO.

Central College,

Bangalore, December 11, 1957.<sup>o</sup>

1. Arie Poldervaart, *Amer. Jour. Sci.*, 1956, **254** (9).
2. —, *Ibid.*, 1955, **253** (8).
3. Johannsen, *Manual of Petrographic Methods*, 1918.
4. Michael, Wyatt, *Amer. Mineralogist*, 1954, **39**, 983.
5. Milner, H. B., *Sedimentary Petrography*, 1953.

### A LEAF-SPOT DISEASE OF *ECHINOCHLOA COLONUM* LINK DUE TO *PIRICULARIA* SPECIES

DURING the month of July 1957, the plants of *Echinochloa colonum* Link. were found to be affected with leaf-spot disease, for the first time at Indore. The above host grows as a weed and is commonly observed growing along with paddy crop. Heavy infection was observed on the plants in the lowlying waterlogged parts of the field. Isolations from the infection spots yielded a species of *Piricularia*. Review of literature reveals that *Piricularia* has not been reported on *Echinochloa colonum* Link.

The infection spots first appear as a small circular, greenish water-soaked spots. If the

humid atmospheric condition continues, these spots enlarge in size and coalesce. With age the centre of the spot becomes straw in colour with dark brown margin around. The leaf-tissue rots in the middle and gets torn. The spots are circular to elliptical and measure from 1 mm. to 6 mm. in diameter. The fruiting bodies are formed mostly on the lower surface of the spot which gives the spot grey appearance.

Microscopic examination of the infection spot revealed the intercellular mycelium. The conidiophores are pale yellowish-brown in colour, septate and bear conidia at the tip. Mature conidia are hyaline to very pale olivaceous, pyriform, two-septate with small hilum at the base indicating the point of attachment. Mature conidia measure  $16.74 \mu$  to  $27.90 \mu \times 7.44 \mu$  to  $11.16 \mu$  with a mean of  $21.30 \mu \times 9.28 \mu$ .

Work regarding identification of species is in progress.

Thanks are due to Shri M. B. Raizada, Officer-in-charge Botany Branch, Forest Research Institute, Dehra Dun, for identifying the host.

Dept. of Plant Pathology, O. P. SHARMA.  
Inst. of Plant Industry, J. L. MERH.  
Indore, M.P., December 2, 1957.

#### A NOTE ON THE SPECIFIC HEAT OF WOOD

THE specific heat of wood is an important property. Along with conductivity and density it regulates the rate of temperature change when wood is heated or cooled. The high specific heat of wood combined with its low thermal conductivity enables it to be used for handles of heated apparatus, match sticks, etc. The specific heat of wood has been investigated by Volbehr (1896), Dunlap (1912), Koljo (1950) and Geiger (1942). While Dunlap and Koljo used the Bunsen ice calorimeter, Geiger used an unsteady cooling method. The specific heat of poor conductors has been measured by Marley (1933) by a cooling method. As this method appeared elegant a few trials were made on Indian woods by this method. The results of these preliminary experiments are recorded in this note.

For these experiments a thermosflask of dimensions given by Marley was used. For measuring temperatures a thermistor with a Wheatstone bridge was employed. The results of the experiments are given in Table I.

While there is reasonable agreement in the values for glycerine, benzene and aniline with those of other investigators, with wood it is not so. In the case of timbers, not only our

TABLE I  
Specific heat of wood and other materials

Material	Sp. heat	Authors
Glycerine	0.596	
Benzene	0.397	
	0.417	Marley
	0.3958	Fergusson
Aniline	0.400	
	0.495	Fergusson
Sodium chloride	0.244	
	0.209	Marley
Shellac	0.381	
	0.36 - 0.41	Bhattacharya
Charcoal	0.293	
	0.277	Marley
Cork	0.512	
<i>Erythrina</i> bark	0.455	
<i>Mangifera indica</i> (wood)	0.380	
<i>Cedrela toona</i> "	0.407	
<i>Calophyllum</i> sp. "	0.398	
<i>Canarium</i> sp. "	0.312	
<i>Zanthoxylum rhetsa</i> "	0.332	
<i>Bauhinia laxi</i> "	0.413	
<i>Cullenia excelsa</i> "	0.310	
<i>Hardwickia pinnata</i> "	0.334	
<i>Pterocarpus dalbergioides</i> (wood)	0.350	
American timbers	0.287 at 18° C.	Dunlap
German timbers	0.259 at 0° C.	Volbehr.
Swedish timbers	0.260 at 0° C.	Koljo

values are higher than those reported by Dunlap (1912) and Koljo, but also vary somewhat with species. Our values are closer to those of Geiger (1942) determined by a cooling method. Dunlap (*loc. cit.*) states that if the specimens are heated or steamed, higher values are obtained. Our specimens had been oven-dried several times. In order to see whether the higher values are due to this cause or are inherent with Indian species or other experimental causes only detailed experiments can say.

Composite Wood Branch, D. NARAYANAMURTI.  
Forest Res. Institute, N. C. JAIN.  
Dehra Dun, December 2, 1957.

1. Bhattacharya, G. N., *Ind. J. Phys.*, 1940, 14, 415.
2. Dunlap, F., *U.S. Dept. Agri. For. Ser. Bull.*, 1912, 110.
3. Fergusson, Allan and Miller, J. T., *Proc. Phys. Soc.*, 1933, 45, 194.
4. Geiger, F., *Holz als Roh und Werkstoff*, 1942, 5, 148.
5. Koljo, B., *Fors. Wiss. Central Blatt.*, 1950, 69, 538.
6. Marley, *Proc. Phys. Soc.*, 1933, 45, 591.



**CYTOLOGICAL STUDIES ON  
SPERMATOGENESIS OF  
*EYPREOCNEMIS* Sp.**

To understand the interrelationship of the local representatives of Indian grasshoppers, a series of cytological investigations has been undertaken. The present communication contains a preliminary account of the studies on meiotic chromosomes of the species, *Eyprepocnemis* sp., belonging to the subfamily Catantopinae of the family Acrididae.

The specimens were collected from different places of Patna town during the months of May to July 1957. Some of the testes were fixed in Sanfelice's fluid and paraffin blocks were prepared in the usual way. Sections were stained in crystal violet and also according to Feulgen's method. Some aceto-orcein squash preparations of testes were made. Living material was also examined under the phase-contrast microscope.

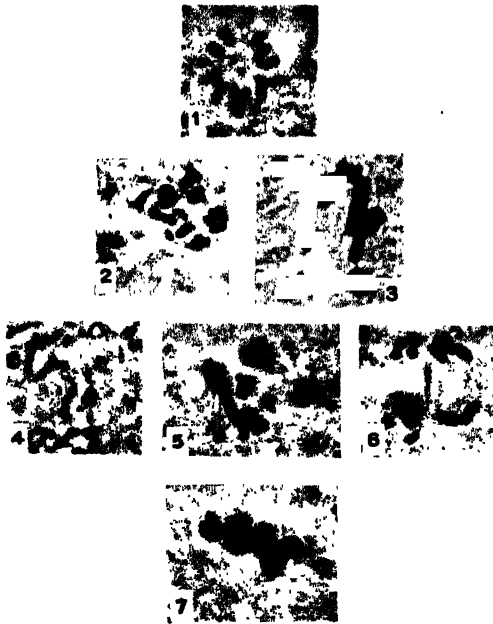

FIG. 1. Photomicrograph of a spermatogonium at metaphase showing full chromosome complement. Polar view,  $\times 2,000$ .

FIG. 2. Photomicrograph of a spermatocyte at diakinesis showing two supernumeraries,  $\times 2,000$ .

FIG. 3. Same as Fig. 2. At anaphase I showing two supernumeraries,  $\times 2,000$ .

FIG. 4. Photomicrograph of a bridge during anaphase I in a living spermatocyte,  $\times 2,000$ .

FIG. 5. Photomicrograph of a dicentric bridge and a fragment. Feulgen's method,  $\times 2,000$ .

FIG. 6. Photomicrograph of the same as Fig. 5 in a different spermatocyte,  $\times 2,000$ .

FIG. 7. Photomicrograph of a secondary spermatocyte at metaphase II,  $\times 2,000$ .

The spermatogonial metaphase plates of different individuals were examined and the chromosome number was found to be  $2x\sigma = 15$ . Some metaphase plates had one or two extra chromosomes of small size. All chromosomes were acrocentric. No heteropycnosis was observed at any stage of spermatogonial mitosis.

Throughout the leptotene and zygotene stages of meiotic prophase I, the X-chromosome remained highly condensed and positively heterochromatic. There were two positively heterochromatic vesicular regions, presumably nucleoli, each attached to a delicate chromosomal thread. The chromomeres were distinct, bead-like, deeply stained structures, strewn on the chromosomal threads. From zygotene onwards, there were seven bivalents, one univalent (X-chromosome) and one or two small unpaired chromosomes in each cell. These extra chromosomes, however, were absent from some spermatocytes. These seemed to be the supernumeraries.

A few bivalents, one in each cell, during pachytene appeared to have a loop which seemed to prevent a small portion of one partner from pairing with the other bead per bead. Fine hair-like projections from the sides of chromomeres distinguished the outlines of pachytene bivalents. The X-chromosome was still more condensed than the autosomes. Nucleolar vesicles disappeared at this stage.

At diplotene, bivalents began separating which resulted in random development of chiasmata. The hair-like projections of bivalents became more distinct due to higher condensation, and chromomeres somewhat more thicker almost losing their separate identity. At diakinesis, the bivalents were much shorter and have characteristic configuration. The hair-like projections were almost obliterated. Metaphase I was as usual. But during anaphase I, there was a dicentric bridge formation in a number of cells, fixed as well as living, of three individuals. In some cells, a fragment or an acentric small chromosome was seen on the equatorial plane, near about the bridge.

These facts indicate that the individuals concerned had a paracentric inversion in the heterozygous condition in their chromosome complement (White, 1954). After telophase, the secondary spermatocytes underwent the second meiotic division passing through a very brief interkinetic stage, when chromosomes uncoiled to a certain extent. In a considerable number of cells, the second metaphase chromosomes show a remarkable abnormality in being joined together to form a chain or network.

In summarising these preliminary findings, it may be pointed out that another species of this genus, *E. alacris*, was studied by Manna (1954) and its chromosome number was found to be  $2x \text{♂} = 23$ . The present species differ from *E. alacris* in having fifteen and one or two supernumeraries in its caryotype. Moreover the above studies provide evidence of the presence of a paracentric inversion in this species. No evidence of syndiploidy or endopolyploidy was found in any individual examined.

The author is indebted to Dr. Suresh Keshava, Head of the Department of Zoology, Patna University, for the laboratory facilities. Sincere thanks are due to the Director, Division of Entomology, Indian Agricultural Institute, New Delhi, for identifying the specimens, and to Mr. J. N. Verma, Artist-Photographer, for taking the photomicrographs.

Dept. of Zoology, NIRMALA CHATTERJEE.  
Patna University,  
Patna-5, November 15, 1957.

1. Darlington, C. D., *Recent Advances in Cytology*, London, 1937.
2. Manna, G. K., *Proc. Zool. Soc.*, 1954, 7, 39-58.
3. White, M. J. D., *Animal Cytology and Evolution*, 2nd ed., Cambridge, 1954.

### SALINITY TOLERANCE OF *ETROPLUS MACULATUS* (BLOCK)

From the evolutionary point of view, the history of fishes shows a migration from the fresh-water to the marine environment. But, while several of the estuarine fishes can withstand transfer to very dilute sea-water or normal 100% sea-water, few truly fresh-water fishes could do so.

*Etroplus maculatus* is a common fresh-water fish occurring in large numbers in most fresh-water ponds and tanks in and around Tirupati in Chittoor District. During the course of a study of the influence of salinity of the medium on fish respiration and its acclimatization to temperature, it was found that *E. maculatus* could withstand direct transfer from pond-water to sea-water diluted to 5‰ salinity. This prompted us to attempt to acclimatize the fish to media of increasing salinity and finally to normal sea-water. The fish were adapted to the following media obtained by dilution of normal sea-water with tap-water. (1) Salinity 5‰; (2) 10‰; (3) 16.3‰; (4) 24‰; and (5) normal sea-water of salinity 32.6‰. It was found that the fish could be transferred from a medium of one salinity to the next without any apparent ill-effects. Batches of

four individuals at a time were acclimatized to media of increasing salinity, starting from tap-water and being transferred successively through the media described above, remaining two days in each intermediate salinity, before being transferred to the next higher salinity. Thus, for example, a fish taken from fresh-water will be directly transferred to 5‰ salinity where it will remain for two days before being transferred to 10‰ salinity and so on till it finally arrives in normal sea-water of salinity 32.6‰. Only in one case an attempt was made to adapt the fish to a medium of salinity higher than normal sea-water. This was done by allowing the sea-water in which the fish were living, to evaporate gradually over a period of days. But when the salinity reached a value of 37‰ the fish died. Throughout the course of these experiments the temperature of the water varied between 25° C. and 27° C.

A detailed account, including a description of the osmotic changes in the blood of the fish, will be published elsewhere.

KANDULA PAMPAPATHI RAO.

Dept. of Zoology,  
Sri Venkateswara University,  
Tirupati, December 3, 1957.

### STUDIES IN THE ENTOMOGENOUS FUNGUS, *METARRHIZIUM ANISOPLIAE* (METSCH.) SOROK.

THE reported occurrence by Kamat *et al.*<sup>1</sup> (1952), of the muscardine green fungus, *Metarrhizium anisopliae* (Metsch.) Sorok, on *Pyrilla* sp. in sugarcane in Bombay has opened up a fascinating and probably an effective field for biological control of the pest. Unfortunately failure in certain seasons of this fungus to control the pest effectively under field conditions, has often evoked considerable doubts regarding its true pathogenic nature. A thorough investigation was, therefore, undertaken at this Laboratory into the various factors influencing the development, sporulation and parasitism of the fungus with special reference to its utilization in the biological control of the pest.

The fungus made excellent growth and sporulated freely on steamed rice, green bean pods, carrot, oat, P.D.A., malt-agar, Cohn's and Bacto nutrient media, medium on corn meal, sweet potato, Richards', Coon's and Czapek's media and scanty on steamed wheat, Knop's and Crabill's media. On P.D.A. sporulation increased with increase in potato concentrate content.

For the purpose of inoculation experiments, the insects were reared from egg-masses in insect-proof, well-ventilated cases. They were then sprayed at different stages of growth, with

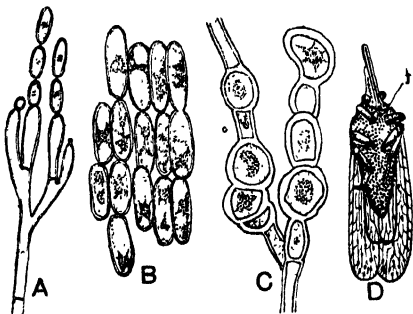

A. Penicilliate conidiophore. B. Conidia.  
C. Chlamydospores D. Growth of the  
fungus (f) on ventral side of the insect abdomen.

a heavy spore suspension of the fungus by an atomizer. The results obtained are presented in Table I.

TABLE I

Parasitism of *Metarrhizium anisopliae* (Metsch.)  
Sorok. on *Pyrilla* sp.

Stages of insects inoculated	Percentage mortality				
	1	2	3	4	5
	%	%	%	%	%
Adults	.. 92	94	91	98	95
Nymphs	.. 90	95	90	92	90
Eggs	.. 0	0	0	0	..

*N.B.*—The figures are based on 10 trials involving 1,400 adults, 375 Nymphs and equal number of egg-masses. Mortality was counted at the end of seven to ten days.

These results established, beyond doubt, the parasitism of this fungus on *Pyrilla* sp. at various stages of growth under laboratory conditions. The inoculated eggs remained non-parasitised and hatched out normally.

The fungus was invariably found to grow over the ventral as well as dorsal sides of the abdomen along the furrows of the abdominal segments from the joints of legs and around the neck. The chitinous and horny parts of the insect body were impervious to the fungus attack.

M.A.C.S. Lab., (Miss) AHILYA P. JAGTAP.  
Law College Buildings,  
Poona-4, October 8, 1957.

1. *Curr. Sci.*, 1952, 21, 317.

### A MARKER GENE FOR RED GRAM (*CAJANUS CAJAN*, MILLSP.)

A NEW character that may also have high economic potential has been observed in red gram (*Cajanus cajan*, Millsp.). Red gram has trifoliate leaves with the three leaflets being almost similar in shape and size. The leaflets are oblong lanceolate, tapering towards the base and the tip, and it is a constant character. Mutations for obcordate<sup>2</sup> and tiny<sup>1</sup> leaflets have already been recorded.

The new character described below was met with in a sample collected from Kurivikulam in Tirunelveli District. The leaflets of this plant are oblong with obovate apex and obtuse base. The leaflets are shorter and broader than the normal. The leaf from the base of the pulvinus to the apex measures slightly less than the normal. The new character is termed as oblong obovate and is different from the round leaflets reported by Pandya *et al.*<sup>1</sup>

The important difference in the characters of the two types are presented in the following table and photographs are presented in Fig. 1.



FIG. 1 A. Red gram plant with oblong lanceolate leaves. Inset.—A single leaf.

FIG. 1 B. Red gram plant (New type) with oblong obovate leaves. Inset.—A single leaf.

The leaf measurements were ascertained from 10 random observations. The differences between the indices of the leaflets (length/breadth) and the entire leaf length (from pulvinus to apex) were statistically significant. The variant plant was found to breed true and it is proposed to pursue the inheritance of the character when further detailed observations will be made.

But for these differences, the new type is similar to the normal. Leaflets with obovate tips and tapering bases are not uncommon in

TABLE I  
Measurements of plants (in cm.)

	A. With lanceolate leaflets			B. With obovate-oblong leaflets		
1 Plant height	.. 105			135		
2 Thickness of main stem	.. 1.2			1.5		
3 Number of branches Nos.	.. 5			7		
4 Length of leaf from pulvinus to apex	10.03±0.244			8.72±0.216		
5 Leaflets:						
(a) Length	I 6.46	II 5.35	III 5.13	I 5.51	II 5.05	III 4.5
Breadth	2.31	2.11	2.12	2.85	2.56	2.4
(b) Length/Breadth index	2.56±0.272	2.80±0.175	2.44±0.083	1.77±0.139	1.94±0.151	2.05±0.114

the subfamily *Papilionacea* to which red gram belongs. But such leaflets have not so far been met with in the cultivated varieties of red gram. The occurrence of this type may possibly be an expression of atavism. This character seems to be associated with the desirable trait of vigour and there is a possibility of its being used as marker gene, for improved strains.

Thanks are due to Sri. B. W. X. Ponnayya, Millets and Pulses Specialist, for giving necessary assistance in presenting this note.

Agric. Res. Station, K. DIVAKARAN.  
Kovilpatti, G. RAMABHADRAN.  
July 22, 1957.

- Pandya, P. S., Patel, J. and Choudhary, B. B., *Poona Agricultural College Magazine*, 1954, **45**, 16.
- Singh, D. W., Bhansali, R. K. and Mital, S. P., *Ind. J. Agr. Sci.*, 1942, **12**, 779-84.

VARIATIONS IN THE HAPLOID CHROMOSOME NUMBER OF *CORCHORUS SIDOIDES* F. MUELL (FAMILY: *TILIACEAE*)

*Corchorus sidoides* F. Muell is a native of Australia and grows in a wild condition. The haploid chromosome number in this species is reported here for the first time to be seven (Fig. 1). In addition to the normal number (7),



FIG. 1. Late diakinesis showing normal seven chromosomes, × 2,100.

FIG. 2. Late diakinesis showing six chromosomes. × 2,100.

FIG. 3. Diakinesis showing eight chromosomes. × 2100.

six (Fig. 2), and eight (Fig. 3), have also been noted. Diploid number is found to be 14.

Hypo- and hyperploidy have been first recorded in *Corchorus olitorius* and *C. capsularis* (the cultivated jute species) by Datta (1952 a & b), and subsequently by Rao and Datta (1953) in *C. fascicularis* and by Sarma and Datta (1953), in a variety of *C. capsularis*. Datta (unpublished) also noted this phenomenon in *C. trilocularis* and its variant, *C. tridens* and *C. æstuans*. Additional observations are now made in this species supporting Datta's contention regarding hypo- and hyperploidy in this genus.

Further details will form the subject-matter of a separate paper.

In the end, I wish to record my indebtedness to Mr. R. M. Datta, Post-Graduate Lecturer in Agriculture, Calcutta University, for his guidance in this investigation and also for the seeds of this species, which were obtained by him from Dr. W. Hartley, Principal Plant Introduction Officer, Commonwealth Scientific and Industrial Research Organization (Division of Plant Industry), Canberra City, Australia. Our thanks are due to him.

Dept. of Agric., SAMBHU LALL BASAK.  
Calcutta University,  
35, Ballyganj Circular Road,  
Calcutta-19, October 18, 1957.

- Datta, R. M., "Meiosis in *Corchorus capsularis* Linn.," *Sc. and Cult.*, 1952 a, **17**, 523.
- , "Irregular meiosis in *Corchorus olitorius* Linn.," *Ibid.*, 1952 b, **18**, 149.
- Rao, N. S. and Datta, R. M., "Chromosomes in the genus *Corchorus*," *Nature*, 1953, **171**, 754.
- Sarma, M. S. and Datta, R. M., "Complex chromosome mosaics and variable microsporocytes in *Corchorus capsularis* Linn.," *Sc. and Cult.*, 1953, **19**, 202-03.

**THE EFFECT OF THYROXINE ON  
PHOSPHATASE, ASCORBIC ACID AND  
TOCOPHEROL CONTENT IN THE  
BLOOD AND MILK OF THE COW AND  
THE BUFFALO**

THE interactions between thyroxine and certain fat and water-soluble vitamins have been studied both in man and animals.<sup>1</sup> These studies are more comprehensive in case of carotene and vitamin A metabolism (Goodwin<sup>2</sup>; Owen<sup>3</sup>) than in case of other vitamins. Previously the metabolism of carotene and vitamin A as affected by DL-thyroxine was studied in lactating cows and goats (Chanda, Clapham, McNaught and Owen<sup>4</sup>; Chanda and Owen<sup>5</sup>). More recently Chanda<sup>6</sup> reported the effect of L-thyroxine on carotene and vitamin A metabolism in the cow and the chick. Whilst some studies have been made regarding the relation between thyroxine and ascorbic acid metabolism (Blaxter, Reineke, Crampton and Petersen<sup>7</sup>; Kon and Henry<sup>8</sup>), the effect of thyroxine on the metabolism of tocopherol received but little attention.

The present communication deals with the effect of thyroxine on the metabolism of ascorbic acid and tocopherol in the cow and the buffalo. As the changes in the milk and blood phosphatase resembled the changes in the two vitamins, the results of the enzyme are also discussed briefly.

Two experiments were carried out; first, on six Haryana cows and the second on six Murrah buffaloes. Each experiment was divided into 3 main periods of 4 weeks each. The hormone treatment was given in period 2, whilst periods 1 and 3 acted as control and recovery periods respectively.

All the experimental animals were in mid-lactation when the experiment started. They were divided into three groups, each group consisting of two animals. Two pairs in case of each experiment were given the hormone treatment, while the third pair in each case acted as controls. All the animals received identical feed and management throughout the duration of the experiment.

The hormone (L- or DL-thyroxine) was given either orally or parenterally. In making the doses comparable it was assumed that oral:parenteral ratio is 16:1, and that the ratio of L-thyroxine:DL-thyroxine activity is 2:1. On this basis a treated animal was given a daily dose of 5 mg. L-thyroxine or 10 mg. DL-thyroxine parenterally. The corresponding oral dose was 80 mg. L-thyroxine or 160 mg. DL-thyroxine. As all the animals exhibited

more or less identical responses, for the sake of brevity only typical results of one cow and one buffalo treated with L-thyroxine orally are discussed in the present communication.

Milk samples from individual animals were analysed on alternate days throughout the experiment whilst blood samples were analysed twice during each period. Tocopherol was separated from the unsaponifiable residue of lipid extracts by adsorption chromatography on alkaline alumina with a slight modification of the method described by Edisbury, Gillow and Taylor<sup>9</sup>; the final colorimetric estimation was made in ethanol by the method of Emmerie and Engel.<sup>10</sup> Ascorbic acid and dehydroascorbic acid were estimated by the osazone reaction of Roe and Kuether.<sup>11</sup> Phosphatase was estimated by the method described by Chanda and Owen.<sup>12</sup> All extinction measurements were made in a Hiiger New Biochem Absorptiometer using the appropriate filter.

*Ascorbic Acid.*—In the milk of both the cow and the buffalo, ascorbic acid was present in the reduced form only, somewhat more ascorbic acid being present in cow milk than in buffalo milk (Table I). In the blood serum, on the other hand, both ascorbic acid and dehydroascorbic acid were present. Whilst there was little difference between the ascorbic acid content of cow and buffalo blood serum, the amount and proportion of dehydroascorbic acid were greater in the buffalo serum than in the cow serum.

Thyroxine treatment caused decreases in ascorbic acid content of both serum and milk, whilst the amount of dehydroascorbic acid in the blood serum showed marked increases in both the cow and the buffalo. The change in the dehydroascorbic acid of the serum due to hormone treatment was so large that the 'total' ascorbic acid (ascorbic acid plus dehydroascorbic acid) also recorded an increase in spite of the decrease in the ascorbic acid (reduced form) by the hormone treatment. As a result of these changes the ratio of ascorbic:dehydroascorbic acid was markedly decreased by the hormone treatment (Table I).

In spite of the greater concentration of dehydroascorbic acid in the blood serum during hormone treatment, there was no evidence of its secretion by the mammary gland under the influence of thyroxine. The reduction in the ascorbic acid content of milk as a result of thyroxine treatment is closely correlated with the reduction in the serum ascorbic acid. The difference between the ascorbic acid content of the cow and the buffalo milk may also be

TABLE I  
Ascorbic acid, dehydroascorbic acid, tocopherol and phosphatase in blood serum and milk

Animal	Period	Daily oral dose of L-thyroxine	Blood serum				Milk			
			Ascorbic acid (mg./100 ml.)	Dehydro-ascorbic acid (a) (b)	a/b	Tocopherol (μg./g. lipid)	Phosphatase (a.u.)*	Ascorbic acid (mg./100*ml.)	Tocopherol (μg./g. fat)	Phosphatase (a.u.)*
Cow	1	None	0.62	0.16	3.88	1026	9.2	1.72	27.2	197
	2	80 mg.	0.48	0.45	1.07	1227	13.2	1.27	20.4	85
	3	None	0.57	0.12	4.75	965	6.7	1.65	30.9	175
Buffalo	1	None	0.55	0.32	1.72	1267	36.7	1.38	29.7	65
	2	80 mg.	0.46	0.52	0.88	1420	47.6	1.12	16.9	49
	3	None	0.53	0.25	2.12	1215	33.6	1.33	22.5	60

\* Arbitrary units (see Chanda & Owen<sup>12</sup>).

attributable to the small difference in the serum ascorbic acid of the two species.

**Tocopherol.**—The results of tocopherol content of milk and blood serum lipids recorded in Table I show that in the pre-treatment period (Period I), buffalo milk fat had less tocopherol than cow milk fat, whilst the serum lipids of the former were richer in tocopherol than those of the latter. During the hormone treatment, the tocopherol content of blood was increased, but that of milk decreased in both the species. The changes in the milk and blood tocopherol are in sharp contrast to the changes in the fat-soluble vitamin A, which was found to increase as a result of thyroxine treatment in both milk and blood serum,<sup>9</sup> but these are strikingly similar to the changes in the water-soluble vitamin C. There appears to be, therefore, a close correlation between ascorbic acid and tocopherol in the milk and the blood of the two species.

**Phosphatase.**—DL-thyroxine is known to decrease the phosphatase content of cow milk (Folley and White<sup>13</sup>; Chanda and Owen<sup>12</sup>). Table I would show that L-thyroxine treatment caused decreases in the phosphatase contents of cow and buffalo milk. It was further observed that in both the species the phosphatase content of the blood serum was considerably higher during hormone treatment than in the control period. These changes in the phosphatase are similar to the changes in tocopherol and ascorbic acid contents, so that the enzyme was found to be correlated with the two vitamins. The buffaloes and the cows were in comparable stages of lactation when the experiments started. It would be seen from Table I that normal cow milk is richer in phosphatase than

buffalo milk, but in the blood serum the reverse is the case.

It is noteworthy that the changes in the three constituents of milk and blood caused by hormone treatment are invariably of greater magnitude in the cow than in the buffalo. It was also found that DL-thyroxine gave somewhat better response than the corresponding dose of L-thyroxine, and that the parenterally administered hormone was slightly superior to oral treatment when given in the ratio of 1:16.

In the control animals which did not receive hormone treatment at any time, the changes in blood and milk ascorbic acid were negligible. Phosphatase recorded some increase in the milk and decrease in blood serum. These changes are attributable to the advancement in lactation as the experiments progressed. Tocopherol content of the blood showed a small but significant decrease with advancement in lactation, but a concomitant change in the milk was not noticeable.

I wish to thank Dr. L. C. Sikka for continued interest in the work. Mr. J. Sen Gupta collaborated in certain aspects of the experiments. Thanks are also due to Dr. T. F. Macrae of the Glaxo Laboratories, Ltd., for a generous gift of synthetic L-thyroxine.

Eastern Regional Animal Nutrition Res. Centre, Haringhata Farm, (Mohanpur) P.O., Dist. Nadia, West Bengal, December 4, 1957.

R. CHANDA.

1. Drill, V. A., *Physiol. Rev.*, 1943, 23, 355.
2. Fordwin, T. W., *The Comparative Biochemistry of Carotenoids*, Chapman and Hall, London, 1952.
3. Owen, E. C., *J. Dairy Res.*, 1954, 21, 408.

4. Chanda, R., Clapham, H. M., McNaught, M. L. and Owen, E. C., *Biochem. J.*, 1951, **50**, 95.
5. — and Owen, E. C., *Ibid.*, 1952, **51**, 404.
6. Chanda, R., *Nature*, 1956, **178**, 541.
7. Blaxter, K. L., Reineke, E. P., Crampton, E. W. and Petersen, W. E., *J. Anim. Sci.*, 1949, **8**, 307.
8. Kon, S. K. and Henry, K. M., *J. Dairy Res.*, 1951, **18**, 317.
9. Edisbury, J. R., Gillow, J. and Taylor, R. J., *Analyst*, 1954, **79**, 617.
10. Emmerie, A. and Engel, C., *Rec. Trav. Chim. Pays. bas*, 1938, **57**, 1351.
11. Roe, J. H. and Kuetner, C. A., *J. Biol. Chem.*, 1943, **147**, 399.
12. Chanda, R. and Owen, E. C., *Biochem. J.*, 1951, **50**, 100.
13. Folley, S. J. and White, P., *Proc. Roy. Soc.*, 1936, **120B**, 346.

### IN VITRO GROWTH OF OVARIES OF *LINARIA MAROCCANA* HOOK.

ALTHOUGH La Rue<sup>1</sup> was the first to achieve some success in growing angiosperm flowers in artificial media, it was really Nitsch<sup>2</sup> who established the *in vitro* technique on a firm footing and showed that the culturing of ovaries under controlled conditions was perhaps the best means of understanding the physiology of fruit. Anataswamy Rau<sup>3</sup> has recently employed this method for studying the effect of colchicine on the early development of the embryo and endosperm in *Phlox drummondii*.

The present study deals with the influence of some growth substances on the fruit and seed development of *Linaria maroccana*, which is grown here as a garden plant. The ovaries were sterilized with 10% calcium hypochlorite solution and inoculated in 10 ml. of nutrient medium whose pH was adjusted between 5.5 and 6. The cultures were kept in diffused light at room temperature (17-21° C.).

Both pollinated and non-pollinated ovaries were tried. The latter did not grow in cultures (except producing some callus and roots) even with the addition of growth substances (Fig. 7). Subsequent study was therefore confined to ovaries picked two days after pollination (Fig. 1). They responded well to Nitsch's basic medium (Nitsch<sup>2</sup>) coupled with vitamins (White<sup>4</sup>), although the fruits thus obtained were smaller in size than controls in field. Following this, it was decided to study the effect of various growth substances on fruit development. Kinetin (0.1 mg./l. to 1.0 mg./l.), in combination with IAA (5 mg./l.), IBA (5 mg./l.), 2, 4-D (2 mg./l.) and adenine (5, 10 mg./l.), was incorporated in the basic medium. While some fruits were slightly larger than those on the basic medium, none of them equalled or surpassed the natural size. The optimum average

length of the fruit obtained in culture was 2.3 mm. in comparison to 5.0 mm. in nature (Figs. 2, 4-6). In another set of cultures, the addition of yeast extract (0.25%, 0.5% and 1.0%) gave better fruit growth than all the preceding media, with an average length of 3.2 mm. (Fig. 3). The percentage of fruit set-



FIG. 1. Ovaries, at the stage of inoculation, excised two days after pollination.  $\times 1.5$ .

FIG. 2. Control fruit *in vivo*, 12 days after pollination.  $\times 1.5$ .

FIG. 3. Fifteen days' growth of fruit in Nitsch's basic medium + Vitamins (NBV) + yeast extract (0.5%). Note callus tissue at the base of the pedicel,  $\times 1.5$ .

FIGS. 4-5. 22- and 38-day old fruits, cultured in NBV + kinetin (0.1 mg./l.) + IAA (5 mg./l.), showing formation of callus and roots from the pedicel and the base of the ovary,  $\times 1.5$ .

FIG. 6. A fruit (32-day old) with callus and well developed root system grown in a medium comprising NBV + kinetin (0.4 mg./l.) + IAA (5 mg./l.),  $\times 1.5$ .

FIG. 7. Non-pollinated ovaries (32-day old) cultured in NBV + kinetin (0.5 mg./l.) + IBA (5 mg./l.). The ovaries failed to grow but callus and roots arose from the pedicel part,  $\times 1.5$ .

FIG. 8. Test-tube fruit (27-day old), grown in NBV + kinetin (0.1 mg./l.) + IAA (5 mg./l.), showing enormous callus growth from the base of the ovary,  $\times 1.5$ .

FIG. 9. Another test-tube fruit (marked by an arrow), showing excessive root formation in 38 days. The medium comprised NBV + kinetin (0.5 mg./l.) + IAA (5 mg./l.),  $\times 1.5$ .

ting was also higher in field (90-95%) than in cultures (40-80%). Though fruits of fully normal size could not be obtained in cultures, the general pattern of fruit growth was more or less similar. In both cases the maximum

size of the fruit was attained 10-12 days after pollination, but the maturity of the fruit was hastened in artificial culture. Mature fruits with black seeds are formed 21-23 days after pollination in the field, whereas in cultures maturity is attained in 15-17 days after pollination. The pericarp of the artificial and control fruits comprises a similar number of cell layers. However, the pericarp of the artificial fruits is more translucent and the black seeds can be seen through the intact fruit wall. This was because of an absence of the usual thickening of the cells in the test-tube fruits.

At the time of inoculation of ovaries, the ovules invariably showed the undivided zygote and two to six endosperm cells. The development of the embryo and the endosperm proceeded similarly in cultured and control fruits, but there was a greater deposition of starch grains in the endosperm tissue of the former. Seeds obtained from *in vitro* fruits were fully viable although they took a slightly longer time (66 hours) to germinate as compared to control seeds (48 hours). However, cultured fruits always showed a greater proportion of aborted ovules. In many cases the ovules developed a black seed-coat but were empty inside.

**Callus Formation on Ovaries.**—The ovaries cultured on the basic medium showed no morphological changes in the pedicel. However, if yeast extract was added to the basic medium, a disc-like patch of callus arose from the cut end of the pedicel (Fig. 3). Its growth ceased after about two weeks and thereafter the cells became brownish to blackish in colour. In many cultures the basic medium was fortified with kinetin in conjunction with IAA, IBA, 2,4-D or adenine. In every case there was an excessive proliferation of the cortical cells from the cut portion of the pedicel, resulting in the formation of a callus. This was followed by the appearance of several small patches of callus all along the pedicel and also at the base of the ovary. Their rapid growth results in a coalescence of the callus groups, eventually leading to a hypertrophy of the whole stalk (Figs. 4, 5). Callusing is also common both on the inner and outer surfaces of the calyx lobes. In a few cases the ovary wall and the base of the style showed some localized meristematic activity. The callus tissue comprises three types of cells. The most common are small actively dividing parenchyma cells which often contain starch grains. Isolated cells, or more often a group of them, developed tracheidal thickenings. Lastly, some of the parenchyma cells enlarged enormously and became highly vacuolated.

**Rooting of Ovaries.**—In many ovaries, after about 18-20 days of growth, root primordia were initiated within the callus; only one or at the most two of them continued to grow and branch profusely (Fig. 6). Root hairs were not confined to a particular zone but were present throughout the entire length of the root (Figs. 8, 9). Some of the root branches became greatly swollen. This localized growth was brought about by the meristematic activity of the cortical cells leading to the formation of a 'secondary callus'. The ovaries cultured on the basic medium, or with yeast extract and kinetin plus adenine combination, failed to give any rooting response. Nitsch<sup>1,5</sup> too observed rooting from the pedicel of tomato ovaries. He considered that during the initiation of roots, the growth of the fruit was retarded, but after the root system was well established, it helped in the maturation of the young fruit. However, in *Linaria* the fruit ripened much before the root system was fully developed.

The use of kinetin in conjunction with some growth substances induced excessive callus and root formation, without any appreciable effect on fruit development. The chief cause of a reduced fruit size in test-tube cultures seemed to be a lower seed setting. It is hoped that it might be possible to get over this difficulty in subsequent trials.

We are greatly indebted to Professor P. Maheshwari for his encouragement and useful suggestions. Thanks are also due to Mrs. Nirmala Maheshwari for her active co-operation in the preparation of this paper.

Dept. of Botany,

R. C. SACHAR.

University of Delhi,

B. BALDEV.

Delhi-8, January 11, 1958.

1. La Rue, C. D., *Bull. Torrey Bot. Cl.*, 1942, **69**, 332.
2. Nitsch, J. P., *American J. Bot.*, 1951, **38**, 566.
3. Rau, Anataswamy, M., *Phytomorphology*, 1952, **6**, 90.
4. White, P. R., *Cultivation of Animal and Plant Cells*, 1954, London.
5. Nitsch, J. P., *Rept. 13th Internatl. Hort. Congr.*, 1952.

#### EMBRYOLOGY OF *AERVA* *TOMENTOSA* FORSK.

In the past few years, we consistently noted the absence of male flowers in *Aerua tomentosa*. For closer study the plants were grown in the University Botanic Gardens. The spikes were carefully examined after every two or three days. Here again, there was no trace of male flowers. But the plants continued to produce normal viable seeds. It was therefore



considered worthwhile to investigate the embryology of *Aerva* in order to understand the mechanism of seed setting.

The pistillate flowers have five to eight perianth lobes and enclose a monocarpellary ovary which is encircled by a ring of eight to ten staminodes. The style is short and is capped by two to three stigmatic lobes.

The ovary contains a single basal ovule with an exceptionally long funiculus. The bitegmal crassinucellar ovule is oriented in an anacampylotropous manner. There is a conspicuous air space in between the two integuments towards the chalazal part of the ovule. This feature is also shared by other members of the Amarantaceæ (Kajale!).

One or more archesporial cells differentiate in the hypodermal position. Usually only one develops (Fig. 1), but occasionally two megaspore mother cells have also been observed. Although hundreds of ovules were sectioned, there was no indication whatsoever of the formation of 'triads' or tetrads. In all probability normal meiosis does not occur. In most of the preparations examined by us the megaspore mother cell enlarges, becomes highly vacuolated and directly assumes the function of a megaspore (Fig. 2). Thereafter, three nuclear divisions take place to give rise to an eight-nucleate embryo-sac (Figs. 3, 4). The organized embryo-sac shows the usual egg apparatus, two polar nuclei and three antipodal cells (Fig. 5). The synergids are ephemeral and degenerate at an early stage. The antipodal cells are persistent and occupy a lateral position on account of the formation of a chalazal cæcum (Fig. 6). Nearly 20% of the ovules abort because of the degeneration of the egg.

Rarely, the megaspore mother cell forms two dyad cells of which the upper degenerates, while the lower develops normally up to the 4-nucleate stage. The final fate of such embryo-sacs cannot be stated definitely at the present moment.

No pollen grains were seen on the stigma. This corresponds with the absence of male plants in the University campus. Acetocarmine squashes and longitudinal sections of styles also failed to reveal any pollen tubes. This confirms that *Aerva tomentosa* is an apomict, and that the egg cell is capable of developing parthenogenetically. In order to verify this experimentally, we bagged many young female spikes with closed buds. In spite of complete elimination of any kind of pollen, 80% of the ovules showed the initiation and normal development of the embryo and endosperm (Fig. 8), and the seeds matured within four weeks.

The free nuclear endosperm shows large irregular nuclei with many nucleoli (Figs. 7, 8). Wall formation begins at the globular stage of the embryo and proceeds from the apex downwards. The embryo corresponds to the Chenopodiad type (Figs. 9-12). When mature it occupies the entire cavity of the embryo-sac (Fig. 13).

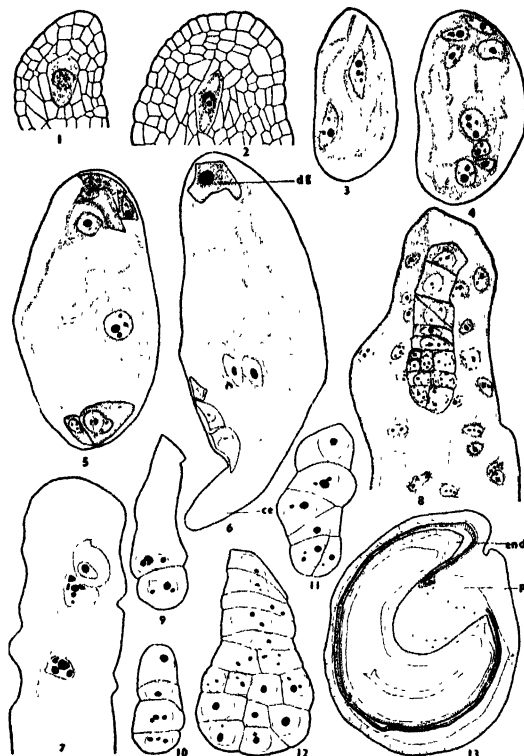

ce, cæcum; dg, degenerating egg apparatus; end, endosperm; p, perisperm.

FIG. 1. L.s. upper part of nucellus with megaspore mother cell,  $\times 220$ .

FIG. 2. Same, showing direct functioning of mother cell into a megaspore,  $\times 220$ .

FIG. 3. Two-nucleate embryo-sac  $\times 440$ .

FIG. 4. Unorganized eight-nucleate embryo sac,  $\times 440$ .

FIG. 5. Mature embryo-sac.  $\times 440$ .

FIG. 6. Mature embryo-sac with degenerated egg apparatus. Note the development of the cæcum in the chalazal part of the embryo-sac,  $\times 440$ .

FIG. 7. Upper part of embryo-sac with undivided egg and two endosperm nuclei,  $\times 220$ .

FIG. 8. Whole mount of an upper part of embryo-sac showing free nuclear endosperm and a proembryo (Dissection from an ovule which grew in the bagged spike),  $\times 220$ .

FIGS. 9-12. A few stages in the development of the embryo,  $\times 340$ .

FIG. 13. L.s. mature seed,  $\times 34$ .

Both the integuments take part in the formation of the seed-coat. A part of the nucellus persists in the form of perisperm and is richly laden with starch grains (Fig. 13).

It may be concluded that the extreme rarity of male plants,\* the suppression of meiosis during megasporogenesis, and the absence of pollen tubes in the ovules indicate that *Acrva tomentosa* is an apomict.

We are greatly indebted to Professor P. Maheshwari and Dr. B. M. Johri for their valuable suggestions and keen interest during the course of this investigation.

Dept. of Botany,  
University of Delhi,  
Delhi-8, January 11, 1958.

R. C. SACHAR.  
PREM MURGAI.

\* Only a single specimen bearing male flowers was obtained from the Lodi Gardens, New Delhi.

[1. Kajale L. B., *Proc. Nat. Inst. Sci., India*, 1940, 4, 597.

### A NEW SPECIES OF THE GENUS *PALLISENTIS* (ACANTHOCEPHALA)

A NEW species of the genus *Pallisentis* has been found from a new host, *Ophicephalus punctatus* (Bloch), and a new locality, Allahabad. The species has been named *P. allahabadii*. The parasite was found in the alimentary canal and body-cavity of about 40% of the fish that were examined. From each infected fish, 1 to 8 specimens of the parasite were collected by me.

Description of *Pallisentis allahabadii* n. sp. (The measurements given are in millimetres)

*Holotype*.—Male: body long, cylindrical, curved, much longer than broad  $4.465 \times 0.304$ . Proboscis  $0.104 \times 0.112$ . Proboscis hooks in four circles of 8-10 each. Collar spines 17 circles of 8-12 each, placed compactly and measuring  $0.028$  each in length. Body spines 25 circles of 1-11 each, measuring  $0.038$  each. Their number is more in the anterior circles than in the posterior ones, the last two circles having only one each. Proboscis sheath  $0.513 \times 0.114$ . Lemnisci unequal, longer  $1.102 \times 0.04$ , smaller  $0.817 \times 0.038$ . Genitalia in posterior half of body. Testes two, anterior  $0.475 \times 0.114$ , posterior  $0.437 \times 0.133$ , touching each other. Prostate gland  $0.4 \times 0.112$  having eight giant nuclei. Prostatic reservoir  $0.361 \times 0.095$ . Prostatic ducts two. Seminal vesicle  $0.608 \times 0.114$ . Bursa  $0.532 \times 0.114$ .

*Paratypes*.—Body ♂  $2.85-5.7 \times 0.285-0.323$ . ♀  $5.795-16.34 \times 0.418-0.95$ . Proboscis ♂  $0.1-0.288 \times 0.1-0.342$ . Proboscis hooks four circles of 8-10 each, each hook measuring  $0.02-0.1$  in length, their arrangement alternating radial. Collar spines 15-18 circles, of 20-25 each in ♀ and 8-12 each in ♂, length  $0.028-0.057$  each. Body spines in ♂ 21-25 circles of 1-12 each, in ♀ 32-36 circles of 1-18 each, length  $0.032-$

$0.064$  each. Number of body spines in a circle decreases posteriorly, last one or more circles having only one or two spines each. Proboscis sheath  $0.437-1.6 \times 0.095-0.48$  reaching upto 8th to 12th circle of collar spines. Longer lemniscus  $0.57-2.75 \times 0.028-0.18$ , smaller lemniscus  $0.418-1.805 \times 0.028-0.064$ . Testes anterior  $0.247-0.475 \times 0.114-0.128$ , posterior  $0.342-0.437 \times 0.128-0.133$ . Prostate gland  $0.323-0.57 \times 0.08-0.171$ , having 8-16 giant nuclei. Pear-shaped prostatic reservoir  $0.228-0.456 \times 0.064-0.18$ . Prostatic ducts two. Seminal vesicle  $0.34-0.9 \times 0.08-0.133$ . Bursa  $0.342-0.665 \times 0.114-0.176$ . In ♀s ovary bursts very early and the body cavity filled with eggs and embryos measuring  $0.02-0.072 \times 0.012-0.028$ .

*Important Characters of Pallisentis allahabadii*.—Collar spines 15-18 circles, of 20-25 each in ♀ and 8-12 each in ♂. Body spines in ♂ 21-25 circles of 1-12 each, in ♀ 32-36 circles of 1-18 each. Number of body spines per circle gradually decreases posteriorly. Lemnisci unequal. Females always more than males. Sexual dimorphism in: body spines, collar spines, and body size. Prostate gland of 8-16 nuclei. Parasite found in host's body cavity also.

*P. allahabadii* differs from *P. umbellatus*<sup>5</sup> chiefly in proboscis hooks, collar spines, body spines, length of proboscis sheath, body size and proboscis size; from *P. nagpurensis*<sup>1,2</sup> chiefly in collar spines, body spines, lemnisci, and the sizes of body, proboscis, proboscis sheath, testes, prostate gland and bursa; from *P. nandai*<sup>3</sup> chiefly in collar spines, body spines, lemnisci, body nuclei, prostate gland nuclei, and the sizes of body, proboscis, proboscis hooks, proboscis sheath, testes, prostate gland, prostatic reservoir, bursa, and seminal vesicle; and from *P. colisai*<sup>4</sup> chiefly in proboscis hooks, collar spines, body spines, lemnisci and the sizes of body, proboscis, proboscis sheath, testes, prostate gland, prostatic reservoir, bursa and seminal vesicle.

The new species is being dealt with in detail in a full length paper to be published elsewhere.

Dept. of Zoology,  
University of Allahabad,  
December 20, 1957.

S. C. AGARWAL.

1. Bhalerao, G. D., *Ann. Mag. Nat. Hist.*, 1931, 7(10), 569-73.
2. Datta, M. N. and Poddar, T. N., *Rec. Ind. Mus.*, 1935, 37, 231-36.
3. Sarkar, H. L., *Proc. Zool. Soc. Bengal*, 1953, 6, 139-47.
4. —, *Rec. Ind. Mus.*, 1954, 52, 349-62.
5. Van Cleave, H. J., *Parasitol.*, 1928, 20, 1-9.

## REVIEWS

**Advances in Nuclear Engineering, Vol. I.** Coordinating Editors: John R. Dunning and Bruce R. Prentice. (Pergamon Press), 1957. Pp. vii + 523. Price £ 7-7-0.

The proceedings of the Second Nuclear Engineering and Science Congress, held at Philadelphia in March 1957, are being published in three volumes by Pergamon Press as a part of its publication programme in the nuclear field. *Advances in Nuclear Engineering* include 134 papers with available discussion and the matter under review comprising of 67 papers forms Volume I of the series.

Atomic energy for peaceful purposes had its roots in the birth of controlled nuclear fission achieved in Chicago for the first time in the history of science and since then a phenomenal advance in engineering materials and practice has taken place in this field. The major present-day peaceful application of atomic energy is in the field of production of electricity and the power element commonly designated as the Reactor is a complex equipment calling for newer materials of construction and novel engineering design. The fuel element employed in reactors occur in the Nature in relatively meagre quantities and often as a non-fissionable isotope. Many problems have therefore arisen in connection with the preparation and processing of fissionable materials, the disposal of waste materials and the by-products of atomic plants. Protection and safety measures are very important aspects especially from the point of view of atmospheric pollution and human tolerance. A variety of new applications of ionising radiations have been conceived of, such as preservation of food materials by radiation, medico-therapeutic applications and control of parasitic infections. The papers comprising the volume deal with these aspects and appear under six sections. Papers under Section I deal with Fuel Cycles. By fuel cycles it is meant that the reactor fuel materials have to be re-processed and returned before it is completely consumed. In the consumption of nuclear fuels in a reactor core or in the production of new nuclear fuels by transmutation, the operation under the present status of reactor technology is normally interrupted after only a small fraction of the desired reaction can take place whether it be fission or transmutation. As a result several cycles of these incomplete recovery and purification operations are neces-

sary to obtain what would correspond to the complete utilization of fissionable or fertile constituents. Reactor fuel materials have to be reprocessed for one or more of the following reasons: (1) to add fissionable material, (2) to restore the heat transfer and structural properties of solid fuel elements which deteriorate due to the destruction of the lattice structure by the fission process, (3) to recover bred fissionable material, and (4) to remove contaminations which act as poisons.

Further, the recovery of unconsumed fuel and of newly-bred fuel or of fertile material discharged from energy-producing nuclear fission reactors appears to be an economic necessity because of the value of uranium, thorium, etc. This has promoted interest in the development of new and better processing techniques for the production of feed materials and for the recovery of spent nuclear fuels. These aspects are presented in Section I which is the longest, under the headings Fuel, Manufacture, Production and Recovery, Fuel Cycle Interrelationships, Spent Fuel Processing—Aqueous, Spent Fuel Processing—Non-aqueous and Economics of Nuclear Fuels.

Section II comprising of three papers is devoted to nuclear power plant containment concepts and design.

Section III under the title plant components contains papers on pumps, piping and valves used in power reactors and fuel handling system for a fast breeder reactor.

Papers on waste disposal are presented in Section IV. A big nuclear power reactor will produce large volumes of waste fission products and other radio-active debris. The disposal of these is a challenging problem and the papers discuss these and the methods of disposal.

Section V bears the title Protection and Safety Measures. Contamination of water-supplies, shielding, structural protection and control of fission products, limits and codes for radiation protection and merchant ship safety are discussed in the papers appearing under this Section.

Radiation processing forms the subject of Section VI. In this, use of ionising radiations in control of parasitic infection and food preservation and the nuclear reactor as instrument of medical research and therapy are treated.

The papers presented in this volume contain an immense wealth of scientific and engineering information and the Pergamon Press deserve to be congratulated for bringing out this volume and making available to the interested up-to-date knowledge in the field of nuclear energy.

A. J.

**Laboratory Manual of Batch Distillation.** By F. J. Zuiderweg. (Published by Interscience Publishers, Inc., New York and London, India: Asia Publishing House, Bombay-1), 1957. Pp. viii + 126. Price \$ 3.50.

No analytical method has been of greater usefulness in the laboratory than 'distillation'. The purpose of this publication, in the words of the author, is 'to provide help and guidance to the chemist who uses laboratory distillation as a tool for analysis, separation and purification of base materials, intermediates or products, but does not intend to specialize in the field'. To a substantial measure, the *Laboratory Manual of Batch Distillation* may serve this purpose.

In this elementary manual, the author has restricted the treatment of the subject only to binary systems of completely miscible phases; and he feels that the problem of distillation of multi-component systems can be approached with a thorough grasp of the 'know-how' of binary liquid-vapour equilibrium. The first two chapters are devoted to theoretical principles underlying distillation. This is followed by a chapter dealing with methods of calculating in a simple manner the requirements of a distillation column for practical purposes. Then follows a chapter on the experimental methods of evaluating column performances and usual characteristics of laboratory columns in operation. The last two chapters deal with a few commonly used laboratory columns with special reference to types of column packing and their bearing on separative efficiency. A brief description of usual accessories and auxiliary equipment for operational control is also included. Thus, the Manual, though an elementary one, helps the analyst to acquire a knowledge of the fundamental principles of distillation and then proceed to simple and fast methods of calculating the general requirements of a distillation column.

In his publication, the author has made effective use of simple problems to illustrate the method of application of formulæ derived in the earlier section of the text, laying emphasis on techniques rather than on designing. However, the treatment of theory and literature reference as well as indexing in the text are

found to be somewhat sketchy and inadequate. A few important monograms in respect of boiling points at reduced pressures, relative volatility, reflux ratio, etc., are also included in the appendix. The book can be recommended for beginners, whether a student or a bench chemist.

In future revisions of this Manual, the author may rectify the following errors which appear in the present edition under review:

1. In page 6 (lines 7 and 8), for primary alcohols the value is about 182° C. and not 177° C. as mentioned in the text.

2. In page 12, equation (12) should read as:

$$1 - X = \frac{\pi_B}{P}$$

and not as  $1 - x = \frac{\pi_B}{P}$  as mentioned in the text.

S. S. GHOSH.

**Volumetric Analysis, Vol. III. (Titration Methods: Oxidation Reduction Reactions.)** By I. M. Kolthoff and R. Belcher, with the co-operation of V. A. Stenger and G. Matsuyama. (Interscience Publishers, New York and London, India: Asia Publishing House, Bombay-1), 1957. Pp. ix + 714. Price \$ 15.00.

This is the third and last volume of Volumetric Analysis and it presents a comprehensive account of the theoretical principles, the technique and the applications of oxidation-reduction reactions.

The first chapter is of an introductory nature describing succinctly the general procedures for oxidation or reduction of substances and the apparatus employed for oxidation-reduction titrations, with a particularly good account of amalgam reductors. The succeeding chapters deal comprehensively with the following volumetric reagents; potassium permanganate, ceric salts, potassium dichromate, iodine, Karl-Fischer reagent, potassium iodate, periodate, potassium bromate, hypohalites, Iron (II), Titanium (III) and other strong reducing agents, with a final chapter (Chapter XV) on miscellaneous oxidising and reducing titrants and titrations in non-aqueous media.

Each chapter gives a critical account of the various procedures employing the particular reagent; preparation of the reagents in a pure state, standardisation of the solution, stability of the solutions prepared, determination of the end point and sources of error, for estimations of inorganic as well as organic substances. Selected references, given as footnotes, will prove of great assistance to the research worker.

This book is a unique combination of several features which make it particularly useful

both to the beginners in volumetric analysis and to research workers who are in search of the best method applicable to the system under investigation. The printing and get-up are excellent, and it provides interesting and stimulating reading. It can be heartily recommended for study by all chemists. K. R. K.

---

**Electrical Gas Discharges.** By Dr. F. N. Penning. (Published by Philips Technical Library), 1957. Pp. viii + 78 with 29 figures.

The research worker approaching the subject of electrical breakdown of gases for the first time is amazed at the mass of literature accumulated on the subject for the last 50 years. The present book brings out in a cogent form the systematic development of the subject over this long period.

There are not many publications on the subject that can be easily followed by a lay reader interested in the field. The book, therefore, fulfils a gap in such literature and gives a bird's eye view of the present position of the subject.

Written for a beginner, the book cannot be anything more than the summing of the facts. Nevertheless it does foster the desire in the reader to pursue the advanced literature on the subject.

The book covers in a nutshell the whole field of electric discharges in an easily understood language by the beginner. While describing the fundamental facts, Dr. Penning has not lost sight of the far-reaching practical applications.

D. J. B.

---

**The Economic and Social Consequences of Automation.** By F. Pollock. (Publishers: Basil Blackwell, Oxford), 1957. Pp. 276. Price 25 sh.

The book is one of the series of enquiries into the changes in the structure of society which were being undertaken by the 'Institut für Sozialforschung' at the University of Frankfurt. Part I contains a historical survey and a discussion of the problems raised by the Introduction of Automation as they appeared in the closing months of 1954. Part II deals with the most important developments both in the theory and practice of automation that occurred in the year 1955, along with some description of the technical methods and devices used in the automatic process of Industrial Production.

More and more people are convinced that a 'Second Industrial Revolution is on the way' and that "machines are to guide and control

other machines". The conveyor belt rationalisation is being pushed to its logical conclusion. During Industrial Revolution, steam engine helped to replace the work of the muscles of men. Automation tends to replace his sensory organs and brain—judge the quality of the product, decide on correction and warn the operator that the machines require attention. Such development may create a new society based on authoritarian and military principles into an Economic General Staff helped by an electronic computer and an up-to-date information for decision. The author describes the feed-back theory, illustrating with practical applications—in Chemical Industry and in Military Science. He then discusses the limitations of automation—the limiting factor of a computer and the shortage of qualified engineers. The savings in automation are many and varied. The importance of automation for underdeveloped countries is stressed.

What are the social consequences of automation? Its influence will be worldwide—it may cause redundancy and it may create a 'privileged minority'. Remedies for technological unemployment are suggested—"Such a class structure would be a very insecure foundation for a free society".

In Part II, development of automation in America, England and Europe during 1955, is traced. The author then defines automation. Two landmarks in the subject of automation are the hearing before the Sub-Committee on Economic Stabilisation in U.S.A. and the Report of the Conference held at Margate, England, during June 16, 19th in 1955. The author discusses the various points raised in these two enquiries, "We need a new breed of executive, who is something of an accountant, a mathematician, a scientist and a production engineer in addition to possessing some business knowledge particular to the individual concern." New electronic devices, automatic machine tools, techniques of operational research, servomechanisms and transfer machines are described. The intensity of the technological unemployment in various industries, compensation for redundant workers, Duckers forecast of labour shortage in U.S.A., automation as a stabilizing force or a distributing influence are then dealt with.

In the seventh chapter, the author throws some new light on the social consequences of automation. How it will affect the workers, the structure of the labour force, their morale, the engineers and the management? What are the political consequences? Will engineers hold society to ransom? What will the workers do

with their leisure? Problems for management will become more complicated—automation may secure a measure of decentralisation. 'Concentration of economic power and of financial control over the production and distribution of goods and services' will increase due to automation. How do the Trade Unions view automation? American labour is not opposed to automation—the British Trade Unions accept it. Is automation a blessing or a curse? Two different views are expressed. The author concludes that "What must be done is to take a long-term view and to plan for the future with the aid of new machines and new techniques. And the object of economic planning must be to integrate automation with a free and democratic society. Success in such planning would mean that the Second Industrial Revolution would help to establish a social system based upon reason".

The analysis of the effect of automation on industry and society is penetrating and thought-provoking and the book should be read by every 'futuristic' Manager, Economist and Sociologist.

R. N.

---

Annual Review of Biochemistry. Vol. XXVI. (Annual Reviews, Inc.), 1957. Pp. ix + 763. Price \$7.00 post paid (U.S.A.); \$7.50 post paid (Elsewhere).

The steady growth in the volume of literature pertaining to the various topics in biochemistry has, understandably, necessitated the transfer to several sister volumes of subjects that seemed more properly oriented towards physiology, microbiology and plant physiology. Also, the increasing realisation of the exact significance of small molecules in biosynthetic mechanisms and consequent interpenetration of several groups of metabolic systems has created demands for discussion of new topics and for considerable reorientation of the traditional divisions of the subject. These changes are only a reflection of the dramatic growth of the whole corpus of biochemistry and of its restless dynamic character. The *Annual Review* will for ever continue to take a prominent position in the shelves of the biochemist, for him to browse in at all times and to serve as a refresher.

Of the twenty chapters in the present volume, there are some which, perhaps, both in their nature and on account of the voluminous literature handled, are more in the nature of synoptic summaries than critical appraisals. Such are, for example, the sections relating to carbohydrate chemistry and metabolism, bio-

chemistry of the steroid hormones, non-oxidative and proteolytic enzymes. Many reviewers have, however, rightly, used the subjective yardstick of personal bent and predilection in the selection of their material for review. This has its limitations, as for example, in the treatment of the chapter on nutrition which is confined only to the consideration of certain stress conditions, viz., atherosclerosis, obesity and hypercalcemia. On the other hand, very readable accounts are provided in the contributions that are confined to biological oxidations, chemistry and biosynthesis of proteins, amino-acid and protein metabolism and the nucleic acids, among others. Topics such as oxidative phosphorylation and electron transport systems, enzymatic synthesis of phospholipids, protein structure and its genetic control, the relationship of structure to function and the biological involvement of nucleic acids which have highlighted progress in biochemistry during the recent past have received critical and comprehensive evaluation. An important revision in knowledge concerning the enthalpy change during the hydrolysis of the pyrophosphate bond of ATP, however, receives only casual mention.

In conformity with usual recent practice of including additional special fields for review once every few years, the present volume contains a contribution on X-ray studies of compounds of biological interest, among which are vitamin B<sub>12</sub>, certain amino-acids, polypeptides, nucleic acids, fibrous and globular proteins, collagen, haemoglobins and viruses. Other special chapters deal with haem pigments and porphyrins, biochemistry of muscle and clinical applications of biochemistry.

A chapter on biochemistry in the U.S.S.R. is an attempt to justify the unavailability, to many workers in the subject, of Soviet biochemical literature and covers a summary of several research papers published in recent years. While it may be conceded that free communication is an essential requisite for healthy development in subjects of fundamental scientific interest, one cannot but express the hope that no necessity will arise for reviewing separately the contributions of a particular nation.

The prefatory chapter this year is from the pen of Prof. R. A. Peters and, in contrast to the objective appraisal of the volume as a whole, makes refreshing reading. Prof. Peters narrates in a charming way his impressions of personalities and events in the forty-five years of his career as a research biochemist. Biochemistry is a fusion of different disciplines and

hence the training of a biochemist is almost that of a devotee. Hence, his best ideas may not always occur in his twenty's or thirty's. Of the future of biochemistry, Prof. Peters has this to say: "The subject is probably at the moment more active even than nuclear physics, so it cannot fail to be an exciting adventure".

A. S.

---

**The Darwin Reader.** Edited by Marston Bates and P. S. Humphrey. (Macmillan & Co., London), 1957. Pp. ix + 481. Price 30 sh.

Darwin's book, *The Origin of Species*, by demolishing the then prevalent belief in the immutability of species revolutionized Western thought and rendered possible a rational approach to the problem of evolution as well as heredity. In that context, his other contributions are of unusual interest, but their bulk and verbiage are forbidding to an ordinary reader.

*The Darwin Reader* is an attempt to illustrate his ideas, with the minimum of editorial intrusion, by selections from his most "readable prose". It is interesting to read in the Autobiography that he narrowly missed being rejected as a Naturalist to the voyage of the Beagle because of the shape of his nose! It was this voyage which paved the way for a "plodding, neurasthenic, shy man" to become one of the greatest intellectual forces of his century.

Many biologists may feel that selections from his important book, "The Variation of Animals and Plants under Domestication" could well have replaced those from "Expression of Emotions" and "Plants and Worms" in this anthology, since the editors themselves remark that pangenesis has an interesting place in the history of science.

We recommend this anthology to the general reader.

M. K. SUBRAMANIAM.

---

**Annals of the New York Academy of Sciences—Second Conference on Sulfonamides, Vol. 69.** Art. 3. 1957. Pp. 377-564. Price \$ 3.00.

This is a monograph on the Sulphonamides comprising of 17 articles by 32 authors (predominantly American) including such authorities on the subject as G. Domagk, P. H. Long, D. Lehr, M. H. Lepper, M. Finland, M. Hamburger and A. M. Rutenburg. The first article is by Gerhard Domagk who was awarded the Nobel Prize in Medicine in 1938 for his discovery of the chemotherapeutic value of prontosil. In this article after summarising the use the sulphonamides have been put to during the

last quarter century, he gives reasons for the recent renewed interest in these antibacterial agents. This is followed by 8 articles on the value of the currently used sulphonamides in clinical practice, including an excellent one on the toxicity of these drugs by Lehr, wherein he restates his arguments for the use of sulphonamide mixtures. The rest of the publication (8 articles) deals with two new sulphonamides—Sulfachloropyridazine and Sulfamethoxy-pyridazine. These articles comprise of reports on therapeutic trials of these drugs both in experimental animals and in clinical cases of bacterial infection. The chief advantage of one of them (Sulfamethoxy-pyridazine) over the current sulphonamides seems to be its prolonged action in the body in virtue of its slow elimination by the kidney (p. 450). This means that the drug could be given at longer intervals both in infections susceptible to sulphonamides (single daily dosage, p. 507), and in the prevention of streptococcal infections in rheumatic patients (once or twice a week, p. 491). There are some repetitions but this is inevitable in a publication of this type.

This is a timely publication when the newer antibiotics are overshadowing the sulphonamides and obscuring their real value. The sulphonamides are cheap (a consideration of great importance in this country) and are now relatively non-toxic. Clinicians, pharmacologists, and biochemists interested in the subject will find it well worth their while to read this monograph.

S. C. DEVADATTA.

---

**Comparative Physiology of the Nervous Control of Muscular Contraction.** By Graham Hoyle. (Cambridge University Press), 1957. Pp. viii + 147. Price 15 sh.

This is one of the series of monographs published from Cambridge on experimental biology. A large amount of work has been done recently on the comparative aspect of neuromuscular control, but has not yet been incorporated in any text-book of comparative physiology. This book gives a unified presentation of recent data, and hence is a very valuable addition to the literature on comparative physiology. It thus fulfils a long-felt need for research students on muscle physiology in particular, and physiologists in general.

Physiology begins with anatomy, and so an initial account of the comparative anatomy of the myoneural apparatus is given. The author then gives a lucid account of the electrical properties of muscle cells, when at rest and when excited. This is followed by a discussion of

neuromuscular transmission, the end-plate or junction potential. The last chapter is devoted to the comparative physiology of the myoneural mechanisms. The subject is fascinating and the book is very welcome.

INDERJIT SINGH.

---

**Parthenogenesis and Polyploidy in Mammalian Development.** By R. A. Beatty. (Cambridge University Press), 1957. Pp. xi + 132. Plates 2. Price 15 sh. net.

Two basic assumptions in biology have influenced our thought during the early part of this century. The first is, that an embryo can arise only after fusion of an ovum and a sperm. The second is that the zygote at fertilization has two sets of chromosomes, one set derived from the ovum, the other from the sperm. That in a large number of lower animals, including lower vertebrates, these assumptions are not only not inevitable but even untenable, has been shown in the work of the past fifty years, during which both parthenogenesis as well as heteroploidy have come to be recognized as established phenomena, met with in nature as well as induced by experiment. The sea-urchin, the chaetopod worm, the mollusc and the insect have all indicated that the individual could arise without fertilization of the ovum by the sperm and that in nature, as well as under experimental conditions, a departure from diploidy could occur. Even the common frog displayed these phenomena, and that was a surprise, for, who would have thought that a highly evolved vertebrate like an amphibian would show these departures from normal development? This however was nothing when compared with the report which appeared some time ago that diploid parthenogenesis occurred in the rabbit, followed by others of heteroploidy in the golden hamster, pig, rabbit and the rat. That a highly organized animal like a mammal could exhibit departures from normal development was highly interesting and offered a challenging field of investigation. This challenge has been picked up by a number of workers, notably R. A. Beatty of the Institute of Animal Genetics, Edinburgh, who has presented a summary of his own work of about 10 years as well as reviewed the accumulated researches of a few others in the field. This has been entirely new work, and difficult work, involving the application of new techniques never before tried on a mammal, temperature and chemical treatments, and irradiation. The result has been the production of wide variety of conditions including triploids and parthenogenetic diploids. So far,

however, no mammal with these abnormal conditions of chromosomes or development has come to term in spite of fascinating claims. But it seems, with the better application of these techniques, the day is not far off when we can answer many obscure questions relating to mammalian development. For, the implications are obvious. In man, they are medical; in domestic mammals, they are economic and in the general fields of pure academic interest, genetics, and problems of sex determination would come in. The whole question of the role of polyploidy in mammalian evolution would have to be met.

The book which Beatty calls a progress report, is really a condensed amount of the fascinating possibilities open to the experimental biologist to whom mammals would seem to offer material nearly as advantageous, and far more exciting, than any hitherto attempted.

B. R. S.

---

**Annals of the New York Academy of Sciences—  
Second Tissue Homotransplantation Conference, Vol. 64, Art. 5, March 1957, Pp. 339.  
Price \$ 4.50.**

From the first tissue homotransplantation conference in 1954 to the second conference on the same subject in 1956 (on which the monograph under review is based) is by no means a long time. However, it appears to have been a period of marked activity in this particular field.

Like other symposia in pure and applied sciences arranged under the auspices of the New York Academy of Sciences, the present symposium should be of considerable help in ascertaining the existing state of our knowledge and in effectively formulating the questions needing immediate attention. While the emphasis in this symposium is mainly placed on basic experimental data, Rogers' paper on the "Genetics of Skin Homotransplantation in the Human" is, a valuable contribution from the clinical, as well as experimental aspect. It is probably a piece of pioneer work in skin homografting experiments, with adequate control material. The study by Good and his colleagues on different aspects of human agammaglobulinæmia, specially in relation to homotransplantation, pregnancy and transplantation of lymph nodes into the agammaglobulin patients is informative and of absorbing interest. The paper on "Prolonged Survival of Skin Homografts in Uremic Patients" by Dammin *et al.* is stimulating and raises some interesting problems.



From the genetical aspect, the experimental data of Eichwald and others suggesting the possibility of existence of a new  $\gamma$ -chromosome linked histocompatibility gene in mice is a valuable contribution. It will help to account for some of the hitherto unexplained cases of homograft rejection. There are several papers which are mainly centred around the concept of "acquired tolerance"—originally postulated by Billingham, Brent and Medawar in the preceding conference. Woodruff's method of inducing a very high degree of tolerance in newborn rats appears to be an aid for future investigations in relation to this phenomenon. Of the several other papers on altered host-graft relationship, the paper by Odell *et al.* on the "Homotransplantation of Functional Erythropoetic Elements" deserves mention because of the light that it may throw upon the mechanism of radio-protection phenomenon by splenic and bone marrow extracts.

There has been considerable discussion recently on the different aspects of bacterial allergy of the delayed tuberculin type. From the basic similarity of behaviour of the tuberculin type of delayed allergic inflammatory response and homograft rejection phenomenon this was only to be expected. The one unmistakable fact that clearly emerges from this fairly full discussion is that our knowledge of the nature of bacterial type of hypersensitivity is still far from adequate. This is specially unfortunate, because as Good *et al.* have pointed out, herein may lie the core of the transplantation problem. However, the wide attention that this subject seems to have been receiving may be expected to portend some interesting revelations during the next symposium planned for 1958.

The only criticism that can be offered after going through this fairly comprehensive symposium is that the graft and the factors associated with its character and nature have not received the attention which it deserves by the participants. It need not be pointed out that the graft is as important as the host in results of transplantation. At least this was the attitude manifested during the First Tissue Transplantation Conference held in 1952, under the auspices of the National Institute of Health, where Hauschka presented a very interesting paper on the methods of conditioning the graft

in tumour transplantation. Unfortunately this interest in the graft seems to have been neglected since the first conference.

V. R. K.

#### Books Received

- The Wealth of India—Raw Materials*, Vol. IV (F-G). (Council of Scientific and Industrial Research, New Delhi), 1956. Pp. xxviii + 287. Price Rs. 25.
- The Mango*. By S. R. Gangolly, Ranjit Singh, S. L. Katyal and Daljit Singh. (Indian Council of Agricultural Research, New Delhi), 1957. Pp. xiii + 530. Price Rs. 40.
- Chemotherapy and the Central Nervous System*. By Henry McIlwain. (J. A. Churchill, Ltd., 104, Gloucester Place, London W.1.) Pp. viii + 328. Price 45 sh.
- High Energy Nuclear Physics—Proceedings of the Seventh Annual Rochester Conference*. Edited by G. Ascoli, G. Feldman, L. T. Koster, R. Newton, W. Riesenfeld, M. Ross and R. G. Sachs. (Interscience Publishers, New York), 1957. Pp. ix + 473. Price \$ 4.50.
- Radiation Effects in Solids*. By G. J. Dienes and G. H. Vineyard. (Interscience Publishers, New York; India: Asia Publishing House, Bombay-1), 1957. Pp. viii + 226. Price \$ 6.50.
- Methods of Biochemical Analysis*: Vol. V. Edited by David Glick. (Interscience Publishers, New York; India: Asia Publishing House, Bombay-1), 1957. Pp. ix + 502. Price \$ 9.50.
- Subcellular Particles in the Neoplastic Process*. By C. P. Rhoads, H. Koprowski and others. (*Annals of the New York Academy of Sciences*, Vol. 68, Art. 2.) Pp. 245-656. Price \$ 5.00.
- The Electrophysiology of the Heart*. By H. H. Hecht and others. (*Annals of the New York Academy of Sciences*, Vol. 65, Art. 6.) Pp. 653-1146. Price \$ 4.50.
- The Species Problem*. Edited by E. Mayr. (The American Association for the Advancement of Sciences, 1515, Massachusetts, Washington 5, D.C.), 1957. Pp. ix + 395. Price \$ 8.75.

## SCIENCE NOTES AND NEWS

### Solar Energy and the Depth of the Earth

Since 1946, N. V. Belov and V. I. Lebedev have published a number of articles in which they have developed their hypothesis of the probable source of energy of endogenetic processes, and now they have presented their final and comprehensive outline of this hypothesis (Belov, N. V. and Lebedev, V. I. *Priroda*, No. 5, 11, 1957). It is based mainly on a characteristic fact in leptology (crystal chemistry), namely, that in the minerals occurring in superficial sedimentary rocks, such as the clays, aluminium is surrounded by six oxygen atoms in octahedral co-ordination, with the Al-O distances of the order of 1.9 Å, while in the minerals of the deep-seated igneous and metamorphic rocks, such as the feldspars, aluminium is surrounded by four oxygen atoms in a tetrahedral co-ordination, with the Al-O distance of the order of 1.7 Å. The contraction of this distance during the downward movement of the earth's crust is, according to the authors, an important source (the effect of radioactive disintegration not overlooked) of energy which produces the rise of temperature in depth, and is consequently responsible for the processes of metamorphism and magmatism. Thus aluminium and oxygen as well as other cations, are acting as accumulators of solar energy, the charging of this 'geochemical accumulator' taking place in the zone of weathering, and its discharge in the depth of the earth's crust. Similar conclusions have been reached by V. A. Saul (*Geochim. et Cosmochim. Acta*, 8, 86, 1955) entirely on the basis of the data of thermochemistry.

### Two New Techniques for Measuring Protein

The method developed by a chemist, A. J. Pinckney, of the Agricultural Research Centre, Beltsville, works as follows: Biuret in alkaline solution is known to react with copper ions to form a violet copper salt. Protein in alkaline solution also reacts with copper ions in the same way as does biuret, because biuret and protein have similar peptide linkages. In each case, intensity of the violet colour serves as a direct measure of protein.

In practice, the operator first prepares the reagent consisting of alkali, copper, and small amounts of glycerine. Glycerine stabilises the copper so that it does not precipitate as the hydroxide. Freshly ground wheat or flour samples are then treated with this reagent and the protein reacts with the copper ions to form a

characteristic violet colour. The intensity of this colour is read in a colorimeter, and the readings are converted to protein values by means of charts that relate colour to protein.

The other method by the chemist D. C. Udy, of the Western Wheat Quality Laboratory, Pullman, Washington, is based on a reaction between orange G dye (a water-soluble disulfonic acid dye) and proteins. The dye reacts with the protein molecule to form an insoluble complex—the protein is bound and cannot be broken down in solution. Therefore a known amount of orange G dye is mixed with the protein. Tubes are stoppered and then agitated to allow complete reaction between protein and dye molecules. Insoluble protein-dye complex and other insoluble dye in the resulting clear supernatant solution is measured in a colorimeter. The protein content of the flour or wheat sample is related to the concentration of unbound, previously prepared.

A single protein analysis can be made within 5 minutes when the agitation step is carried out in a semi-micro electric blender container.

So far, the Udy method has been used effectively on wheat and barley products, and on dry and whole milk. It can be applied to many other products where protein is important.

### Aluminium Soldering Simplified

Simple and effective techniques for soldering aluminium and its alloys as well as galvanized metals have been developed by G. M. Bouton and P. R. White, metallurgists at Bell Telephone Laboratories. These techniques employ an inexpensive and stable zinc base alloy as a preferred solder and no flux or vigorous abrasion is necessary. Joints in aluminium made by these methods are stronger than commercial aluminium itself.

Long-term stability of the soldered joint is assured by the rigid exclusion from the high purity zinc base alloy of deleterious elements such as lead, tin, bismuth and cadmium to prevent intergranular corrosion. A fraction of a percent of magnesium may be added to enhance its stability, and up to several percent of aluminium may be included.

In soldering aluminium, it is not necessary to remove rolling mill oils, or the surface oxide from the area to be wetted. A single stroke of the solder stick across the heated aluminium surface will cause the solder to penetrate the oxide and wet the aluminium. The normally

tenacious oxide film is lifted off much like paint peeling from wet wood. This raised oxide coating may then be wiped aside. Surfaces thus wet, can be joined by bringing them together and adding more solder by drawing the solder stick across the hot metal pieces. Heat may be applied electrically or by means of torches burning common fuels.

This soldering technique is equally effective for joining galvanized surfaces without a flux. Joints produced by this method are strong and stable (*Jour. Frank. Inst.*, 264, 1957, 523).

#### Low Temperature Physics Conference

The Sixth International Conference on Low Temperature Physics will be held in Leyden, during June 23-28, 1958, in connection with the fiftieth anniversary of the first liquefaction of helium by Kamerlingh Onnes. Further information can be obtained from Dr. J. van den Handel, Kamerlingh Onnes Laboratory, Leyden, The Netherlands.

#### Azaserine II

The actinomycetes have already given man such important antibiotics as streptomycin, aureomycin, etc., of clinical significance in infections normally insensitive to penicillin. Perhaps the most interesting of the recently studied antibiotics is azaserine, an antibiotic procured from the *Streptomyces fragilis*.

Azaserine (II) is a complex amino acid, the early studies of which suggested great promise as a clinical expedient in the treatment of malign growths. The anti-cancer nature of this antibiotic was first observed by Stock in 1954, who demonstrated that (II) prevented the incorporation of formic acid into nucleic acid.

Azaserine, like other anti-cancer agents, owes its therapeutic effects to its ability, therefore, to interfere at appropriate sites in the metabolic pathway leading to the synthesis of nucleic acid purines and pyrimidines, the latter being important since these structures constitute significant residues in the deoxyribonucleic acid chains of the chromatin material of the dividing cell nucleus. By impeding the growth of the chromatids in the chromosomes, the random proliferation so characteristic of a cancer cell is thought to be slowed down. Thus azaserine (O-diazo-acetyl-L-serine) has shown the pronounced necrolysis of Crocker Mouse sar-

coma 180 and regressions in the Erhlich's ascites carcinoma (*Chem. Products*, Jan. 1958).

#### Non-Ferrous Metallurgy

The Metallurgy and Beneficiation Institute of the Kazakh SSR Academy of Sciences did a considerable piece of work in this field in the last few years.

The method of matte-smelting of oxidized nickel ores used at present means a loss of 25-30% of nickel in the water jacket slag. Such great losses of this valuable metal are due to the nickel sulphide dissolving in the slag. Besides this, drops of matte become mechanically mixed up in it. The Institute worked out the method of smelting oxidized nickel ore on a mixture containing phosphorite instead of gypsum or pyrite. Phosphorus ferro-nickel insoluble in water jacket slag and containing 2-6% of phosphorus is obtained when smelting such mixtures with oxygen blasting. Phosphorus ferro-nickel has a low melting point, good fluidity, and separates easily from slag due to its high specific gravity. Further treatment is of no difficulty.

The new process of smelting oxidized nickel ore raises the extraction of nickel by 15% and cobalt by 30%, increases the output of the furnaces (water jacket furnaces) by 1½ times.

The Institute designed a combined furnace for roasting and smelting weighed copper concentrates on warm air enriched with oxygen.

The tests of this furnace have shown that this method of smelting makes it possible to obtain matte containing 70% of copper, to increase two-fold the output of the furnace as compared with the reverberatory furnace.

#### First All-India Congress of Zoology, 1958

The Zoological Society of India is organising the First All-India Congress of Zoology at Calcutta from October 31 to November 6, 1958. It is for the first time that an attempt is being made in India to hold such a Conference and bring all the zoologists of the country. A number of delegates from foreign countries are also expected to attend. Dr. B. S. Chauhan of the Zoological Survey of India, Calcutta, is the local Secretary. The last date for submission of papers to be read before the Congress is August 15.

---

286-58. Printed at The Bangalore Press, Bangalore City, by C. Vasudeva Rao, Superintendent, and Published by A. V. Telang, M.A., for the Current Science Association, Bangalore.

All material intended for publication and books for review should be addressed to the Editor, *Current Science*, Raman Research Institute, Bangalore-6.

Business correspondence, remittances, subscriptions, advertisements, exchange journals, etc., should be addressed to the Manager, Current Science Association, Raman Research Institute, Bangalore-6.

#### ANNUAL SUBSCRIPTION

India : Rs. 8+00. Foreign : £ 0-16-0. \$ 2.50.

## THE QUANTUM HYPER-FREQUENCY AMPLIFIER--THE MASER

MICROWAVE electronics is full of novel features and is a fascinating field which in the last decade has made great headway.

The techniques for generation, amplification and transmission at microwave frequencies have had to depart from the methods of radio frequency electronics, in order to overcome certain functional limitations of tubes and transmission lines, commonly employed at lower frequencies. When one is considering propagation in a waveguide, the ordinary two wire line transmission ideas and the concept of current and voltage can no more be visualised in them. The behaviour can only be understood in terms of electromagnetic wave equations.

Similarly, tubes generating microwaves function on a new principle known as velocity modulation in which the electron beam interacts with a tunable cavity or cavities, experiencing in their passage through the tube column, a velocity change, depending upon the sign and magnitude of the exciting alternating voltage. The result is usually a bunching up of electrons with respect to time, and such bunched electrons when they interact with the cavity, transfer energy to it in the form of electromagnetic radiation. The travelling wave tube which is used as an amplifier in the microwave region makes use of a distributed interaction between an electron beam and a travelling wave.

While all the electrical amplifiers in use today, including the above, employ the motion of charged particles in electric or magnetic fields, very recently a totally different method has been discovered for amplifying electrical signals at microwave frequencies. The amplification is achieved by stimulated emission of radiation under suitable circumstances. The device which uses this principle is called a *maser*, the word having been coined from the words *micro-wave amplification by stimulated emission of radiation*.

The maser principle was suggested by Weber in 1953 and again independently by Barrow and Prokhorov in 1954. The idea was used in a microwave spectrometer by Gordon, Zeiger and Townes in 1954. In the last few years a large number of papers have been published on the subject analysing the theory and proposing new ways of incorporating the idea into practical devices.

### THE PRINCIPLE OF MASER OPERATION

Energy transitions associated with atoms and molecules are restricted to only a set of "stationary states", each of which is characterised by a definite amount of internal energy. In free atoms and molecules, and also sometimes in atoms in a solid, the energy levels are sharp and transitions between them can be induced by electromagnetic radiation of appropriate frequency. If two levels between which transitions take place have energies  $W_A$  and  $W_B$ , the frequency given to the radiation field or taken from it is given by  $\nu_{AB} = (W_B - W_A)/h$  where  $h$  is the Planck's constant.

From quantum mechanical grounds we have, that such transitions are likely, only when the frequency of the radiation that is interacting with the system is nearly equal to  $\nu_{AB}$ . When the electromagnetic radiation induces a transition in which the atom gains energy, this energy is taken from the electromagnetic wave. Likewise, when the radiation induces a transition in which the atom loses energy, this is added to the electromagnetic wave. This addition is in the form of one photon of frequency  $\nu_{AB}$  that is coherent with the exciting wave (has the same phase, direction and polarization).

A very general thermodynamic argument due to Einstein proves that the probability, that the radiation will induce an atom that is in state A to go into state B is equal to the probability that the same radiation will induce the reverse transition, that is from state B to state A. When matter is in thermal equilibrium the number of species in the  $i$ th state is proportional to  $e^{-w_i/kT}$ , where  $w_i$  is the energy of the  $i$ th state,  $k$  is the Boltzmann constant and  $T$  is the absolute temperature. If the state B has higher energy than state A, the ratio of the number of species in the two states will be

$$\frac{N_B}{N_A} = e^{-h\nu_{AB}/kT}$$

If the atoms are in thermal equilibrium at any temperature  $T$ , there are more atoms in the lower state than in the higher state and therefore, more transitions upwards take place than in the reverse direction. This would result in a net absorption of energy from the radiation. If, however, by some means we can get more atoms or molecules in the higher energy state than in the lower, there will be a net transfer of energy to the radiation field

which would result in power being added to the electromagnetic wave. This would result in amplification, and is the principle of operation of the maser amplifier.

Thus, for a maser to function as an amplifier at a given frequency, a working substance, namely, an atom or molecule, with energy levels having the requisite separation and between which the probability of induced transition is sufficiently large should be chosen. A suitable method should also be found to collect more atoms in the upper state than the lower. Finally, it is necessary to devise a technique for the radiation to interact with the working substance. A number of ingenious masers have been built and operated but all of them in the microwave region.

#### MASER EMPLOYING AMMONIA MOLECULE

The configuration of the ammonia molecule is a triangular pyramid with the nitrogen at the top of the pyramid. Two configurations are shown in Fig. 1 and these have different energies, one representing the ground level and the other lying at an energy level slightly above. Transition between these levels can take place and this is known as 'Ammonia inversion' discovered by Cleeton and Williams in 1937. The frequency of this transmission is in the microwave region at 24,000 Mcs. per second ( $\lambda = 1.25$  cm.).

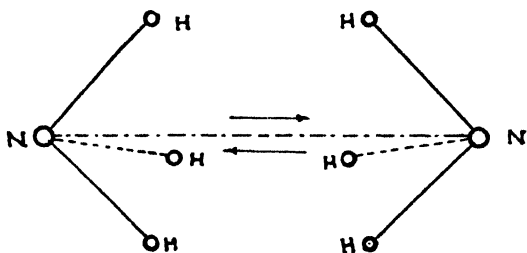

FIG. 1. Ammonia Inversion.

In employing ammonia for maser operation, the segregation of the species lying at the higher energy level is achieved by making use of the Stark effect. The ammonia molecules, as a well-collimated beam issue forth from a source chamber S [Fig. 2 (a)] and the beam is directed along the axis of an electro-static focussing system consisting of four or more electrical conductors [Fig. 2(b)] that are made alternately positive and negative.

In such a focussing system of electrodes the gradient of the electric field strength is away from the centre of the beam. Molecules in the

upper state are pulled in, towards the beam axis, while those in the lower state are expelled outward from the beam and thus physical separation of the molecules in the two states is accomplished. Molecules in the upper energy level is allowed into a microwave cavity C [Fig. 2 (a)] resonant at 24,000 Mcs.

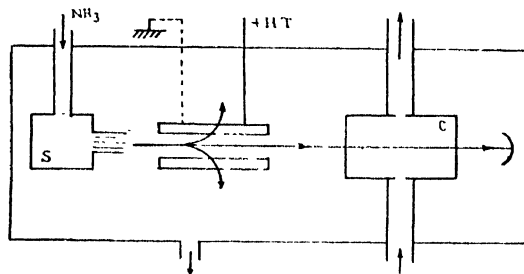

FIG. 2(a)

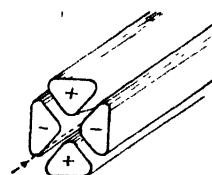

FIG. 2(b)

FIG. 2(a). Diagrammatic Representation of a Molecular Amplifier.

FIG. 2(b). Focussing Electrodes.

If, now, microwave wave radiation of this frequency is fed into the cavity, the molecules in the higher state give up their energy by stimulated emission of the same frequency and add radiant energy to the cavity. The radiation can induce the reverse transition and take up energy from the cavity. This, however, does not take place to any appreciable extent since a continuous stream of fresh charge of molecules at the higher energy level is brought into the cavity, and spent molecules are pushed out. Thus, on the average, energy from the molecule is added to it. If this gain in energy is greater than the losses in the cavity, more power can be taken from it than is supplied. Amplification at the frequency of 24,000 Mcs. has been obtained with ammonia molecule as the working substance.

An amplifier of this type can also be used as an oscillator. Such oscillators have very high frequency stability. The frequency of such an oscillation has been observed to have a random drift of only one part in  $10^{13}$  in a period of two hours. The power output of the ammonia

maser amplifier is low—of the order of  $10^{-10}$  watt. But the great advantage of the ammonia maser is the low internal noise compared to the conventional amplifiers and because of this, amplification of very much weaker signals is possible with masers.

SOLID STATE MASER

The most successful maser amplifiers developed so far have been solid state three-level masers. Energy levels in a solid are very broad generally, but there are some atoms belonging to the transition and rare-earth elements notably, possessing sharp enough energy levels to be used as masers. Since such atoms are situated in a crystal lattice the levels undergo splitting because of Stark effect due to internal crystalline fields. Application of a magnetic field causes further splitting of the Zeeman type.

In Fig. 3 are represented three energy levels in a crystal. When the levels are in thermal

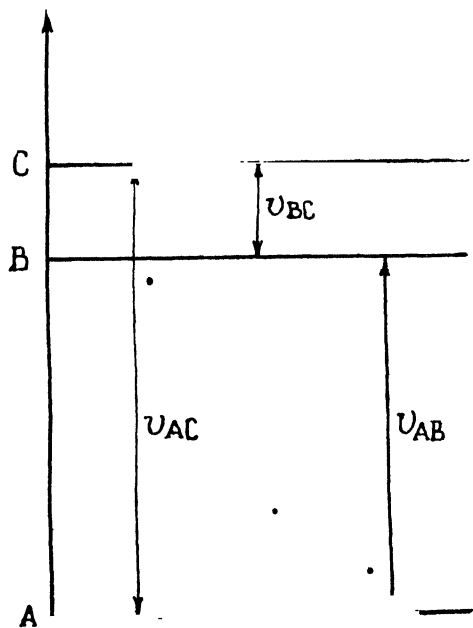

FIG. 3. Energy Levels in a Solid State Amplifier.

equilibrium the relative population in levels B and C will be  $e^{-h\nu_{BC}/kT}$  and  $e^{-h\nu_{AC}/kT}$  times the number in level A. When the crystal is exposed to intense radiation of frequency  $\nu_{AC}$  a new equilibrium will be established, which equalises the numbers in levels A and C. The number in B however will be either less or greater

than A or C, depending upon the relative transition probabilities. If the transition probability for transition C-B is greater than B-A the number in B will be in excess of A. On the other hand, if the transition probability B-A is greater than C-B the number in level B will be less than in the levels A or C. In the former case where  $T_{CB} \gg T_{BA}$  a maser operation of the crystal is possible at the frequency  $\nu_{AB}$  while on the other hand when  $T_{BA} \gg T_{CB}$  maser operation is possible at frequency  $\nu_{BC}$ .

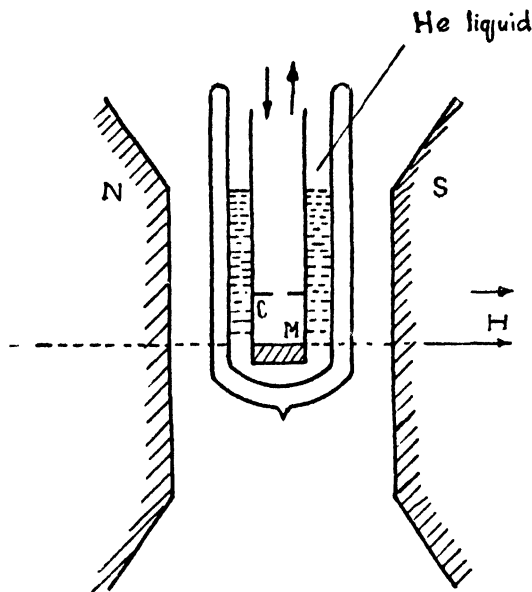

FIG. 4. Solid State Amplifier Operating at Liq He Helium Temperature.

Solid state masers are operated at liquid helium temperatures ( $4^\circ$  K. or lower) for several reasons. The maximum gain obtainable will depend upon the population difference between levels B and A ( $N_B/N_A$  large). The maximum value of this ratio is  $e^{-h\nu_{BC}/kT}$ . If therefore the population in B has to be greater  $\nu_{BC}/T$  should be large. Hence, the lower the temperature is, the higher the gain. Another important reason for operating at low temperature is that the desired low values of the lattice induced transition probabilities are attainable only at low temperatures. An enhancement of this transition probability contributes to the noise level of the amplifier. Further, such enhancement necessitates the expenditure of more power to maintain the equilibrium of population densities.

In spite of difficulties, successful amplifiers of this type have been constructed at Bell Telephone

Laboratories by Scovil, Feher and Seidel and by J. W. Meyers at the Lincoln Laboratory, M.I.T. The Bell Telephone maser uses a gadolinium atom in a crystal of gadolinium ethyl sulphate, operating at 9,000 Mcs. The Lincoln Laboratory maser uses chromium atoms in potassium chrom cyanide and operates at 2,800 Mcs. It amplifies linearly upto an output of  $10^{-6}$  watt with a maximum output of  $10^{-5}$  watt. The amplifier has gains of 40 db. and 10 db. with bandwidths of 25 and 500 Kcs. The noise temperature has been estimated conservatively at 100° K.

#### NEGATIVE TEMPERATURE MASER

In this method the atoms are placed in a magnetic field  $H$ , where the ground state splits into a number of magnetic sublevels. The energy of the  $i$ th sublevel, with respect to its zero field value, is given by

$$E_i = \mu_0 g M J_i H$$

where  $\mu_0$  is the Bohr Magneton,  $g$  is the Lande 'g' factor and  $M J_i$  is the component of the total angular momentum of an atom in the  $i$ th state in the direction of the magnetic field, in units of  $h/2\pi$ . When thermal equilibrium is established, the number in each level is proportional to  $e^{-E_i/kT}$ . Now, if the direction of the magnetic field is suddenly reversed, the value of  $M J_i$  for each state is suddenly multiplied by  $-1$ . A state that had energy  $E_i$ , now has energy  $-E_i$ . Thus, the population of these states become proportional to  $e^{+E_i/kT}$ , the distribution they would have according to the Boltzmann formula for a temperature of  $-T$ ; hence the term negative temperature. We have thus the requisite condition for maser operation, namely, a greater number of atoms in the upper state than in the lower.

Though this maser has got the advantage that it can be tuned to different frequencies by varying the magnetic field, it has other disadvantages. The operation of the maser will be intermittent because the energy source has to be periodically recharged. Further, a very low noise temperature is required in order to obtain a large population difference between the states.

#### OPTICALLY PUMPED MASER

Though a maser of this type has not been successfully operated so far, the idea of obtaining an excess population by optical pumping process is an interesting one. The case can be well discussed by taking sodium atom.

The familiar yellow lines in the spectrum of sodium atom are produced by transition from  ${}^2P_{3/2}$  and  ${}^2P_{1/2}$  states, to the ground  ${}^2S_{1/2}$  state (see

Fig. 5). When a sodium atom is placed in a magnetic field these levels undergo Zeeman splitting. The frequency that causes a transition between the  $MJ = 1/2$  and  $MJ = -1/2$  sublevels into

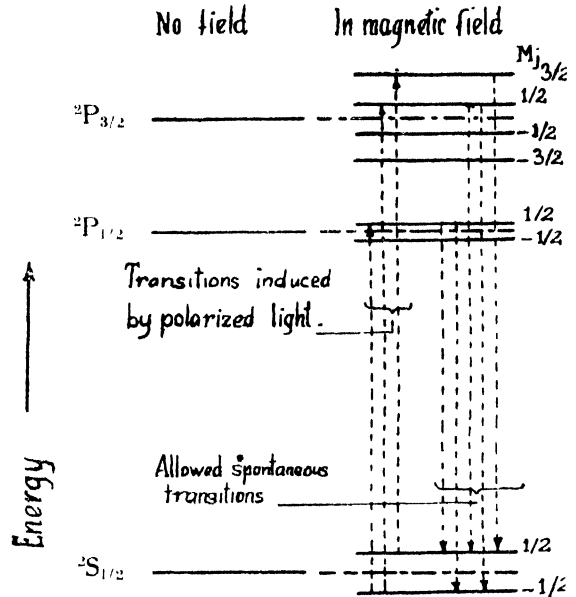

FIG. 5. Energy Levels in Sodium Responsible for the Yellow Lines and their Splittings in a Magnetic Field.

which the ground state splits is 5.6 megacycles per gauss of the applied. If circularly polarised light from a sodium lamp is directed into the sodium vapour kept in the field along the direction of the applied field, the light is absorbed by atoms in the ground level, undergoing excitation into one or the other of the  ${}^2P$  levels. Because of the circular polarisation of the light, only transitions in which  $MJ$  changes by 1 are allowed. These excited atoms spontaneously emit a photon and drop down to one of the  ${}^2S$  levels, the allowed transition in this case being for changes in values of  $MJ = \pm 1$  or 0. It can be seen from the diagram the atoms can be pumped into the higher of the  ${}^2S$  states resulting in an excess population at the level.

This principle as stated at the outset has not resulted in any practical form of maser but offers promising possibilities.

Though the maser technique is of very recent origin and has not yet passed out of the research stage to the concrete instrumental stage, its possible future applications has aroused much interest. As stated, the low noise characteristic of this amplifier makes it especially suitable for greater ultimate sensi-

tivities in the field of radio astronomy, communication and radar. Especially, in radio astronomy where the signal strength is much smaller than the noise of the presently available amplifiers, this new principle of amplification

would have very fruitful applications. Masers can be designed to oscillate at very stable frequencies, thus providing highly accurate time standards.

A. JAYARAMAN.

---

### MAX PLANCK

**T**HERE are events in the development of Physics which reach far beyond the boundaries of science and have a decisive influence on the fate of humanity as a whole. Max Planck's *Quantum Theory* is an example of such a revolution of thought. Twenty-third April 1958 marks the 100th Anniversary of the birth of one of the greatest theoretical physicists of our times. Max Planck was born in Kiel on April 23, 1858, of family which had produced many government officials, jurists and scientists. When he was nine years old, his family moved to Munich. There, he attended the Maximilian Gymnasium and studied at the University for three years, acquiring a solid knowledge of Physics. However, the real spirit of research in Physics became apparent to him, only when he first came into touch with the work of Helmholtz, Kirchhoff and Clausius in Berlin.

Until 1877, Max Planck was a University Instructor in Munich. Two years later the Philosophy Faculty of the University of Berlin offered him a chair. Thus, Planck came in a world centre of science to work at the side of his venerated and admired Helmholtz. Here he advanced his thermodynamic research and arrived, thereby, at an entirely new field—Thermal Radiation.

From 1896 onwards Planck's principal goal was the theoretical derivation of the Laws of Radiation. Entropy had always appeared to him to be the essential concept of the Thermal Theory. Planck then turned to radiation and discovered the famous Radiation Formula which he made public at a Meeting of the Berlin Physics Society on October 19, 1900. He recognized that radiated energy was not arbitrarily divisible, but had a type of atomic structure, or, as Planck said, exists in an ascertainable fixed quantum. The radiated energy quantum of a fixed frequency is proportionate; the proportionality factor signified by letter 'h' is a universal constant, which Planck called the efficiency quantum—usually called simply "Planck's Constant".

In 1905, Einstein took up the quantum idea. He showed that Planck's first interpolative

derivation of the Radiation Formula can be so expanded that the existence of the energy quantum appears to be an inevitable result of the observed spectrum of thermal radiation. He further showed that there are many other phenomena of an entirely different sort where the quantum comes under observation directly, as light quanta—or, as it is called today, a Photon—for instance in photo-electric effect.

At the insistence of Planck, Einstein was called to Berlin in 1913 to a special position in the Prussian Academy where he could pursue his research without the burden of teaching duties.

Through the united efforts of Planck and Einstein, Berlin was the world centre of theoretical physics for almost twenty years. Two of the most eminent of them, Max von Laue and Lise Meitner, also worked in Berlin in this period and contributed to the lustre of physics in that Capital. Students who wished to hear Planck's famous lectures streamed in, from every land. These lectures were printed in six small volumes and contributed much to the dissemination of Planck's ideas. Planck was made permanent Secretary of the Mathematics and Physics Department of the Berlin Academy and gave much time and effort to this task. In 1928 at the age of seventy he retired from his teaching position at the University of Berlin. His successor was Erwin Schrödinger, one of the discoverers of wave mechanics. However, Planck retained the leading position at the Academy.

When the National Socialists seized power in 1933 and began to dismiss many officials and professors because of political unacceptability or Jewish ancestry, Planck, as President of the Kaiser Wilhelm Society, attempted to intervene with Hitler on behalf of various colleagues. He had no success. Einstein announced his withdrawal from the Academy and thereby spared his friend the humiliation of having to inform him of his expulsion. Schrödinger, although uncontested, resigned his Professorship of his own free will and went abroad. The great period of theoretical physics was over in Berlin.



The final stage of the war brought Planck his most severe trial. His son, Erwin, the only surviving child of his first marriage, was involved in the attempt on Hitler's life on July 20, 1944, and condemned to death. Then, Planck stood before the most difficult decision that can confront a man. A reprieve was offered to his son provided Planck signed an oath of loyalty to Hitler. He refused the signature and his son was executed.

Planck's house in the Grunewald, a suburb of Berlin, was destroyed in an air raid and all his possessions including his valuable library were lost. Together with his wife, he took refuge on an estate of a friend at Rogatz near Magdeburg. There, they were caught between the advancing Allied armies and the retreating German army. The battle roared around them for days, until finally they were brought to Göttingen by American troops. Planck found a new, simple home in Göttingen, but hardly ever came to rest there since he felt it his duty to accept invitations to lecture, which carried him on long and strenuous journeys.

In 1946, Planck took part in the observance of the 200th anniversary of Newton's death (postponed), which was arranged by the Royal Society in London, and was honoured as the founder of a new research period in phy-

sics. Honours of every sort were heaped upon him—Doctorates of all Faculties in many lands; memberships or honorary memberships in leading Academies; the Nobel Prize of 1919; the Goethe Prize of the City of Frankfurt for 1946, and many other prizes, orders and medals.

A great celebration was planned in honour of his ninetieth birthday. However, a month prior to this day, Planck's health broke and he died in Göttingen on October 4, 1947. A memorial service was held on April 25, 1948, in Göttingen in which representatives from all over the world as well as from all parts of Germany participated.

Today, more than fifty years after his great discovery, the significance of Planck's life work can well be assessed. Through Planck's thought, nuclear physics has become an exact science, with its own laws which differ in a characteristic manner from those of the classical theory. With the passage of time these laws have been systematized under the names Quantum Mechanics and Quantum Electrodynamics, to a perfection equalling that of the classical Celestial Mechanics which until 1900, was considered to be the model of an exact theory. The Nuclear Age, on the crest of which we stand, with all its hopes and dangers, would be unimaginable without the theoretical equipment provided by the Quantum Theory.

---

### NEW TYPE OF REFLEXES

**T**HE discovery of a new type of reflexes has been announced by Leonid Krushinsky, Professor of Physiology, at Moscow University.

Krushinsky has been studying reflexes in animals for a long time and his experiments have led him to the conclusion that animals, besides having conditioned and unconditioned reflexes, have a third type which he calls extrapolatory or prognosticating reflexes. This type is the basis of rational activity and of the ability of highly organised beings to conceive a picture of a process as a whole, to compare individual phenomena and foresee future events whose causes are sensed by the organs of the animal.

He has established that certain species of animals and birds possess extrapolatory reflexes in varying degrees of development which is a direct result of their environment. They are innate, but become manifest when sufficient experience has been gained.

Krushinsky believes that the basis for the emergence of these reflexes is the existence in

the cortex of the brain of special neuron apparatus—"an operative memory"—which selects and records the natural regularity of certain changes, the direction and speed of movements in particular. It is the knowledge of these regularities that makes it possible to forecast (extrapolate) the subsequent changes and to react to them properly.

Thus, this new type of reflexes, in contrast to the conditioned and unconditioned, is not a direct reaction to a stimulant acting at a given moment. Moreover, in certain cases they may clash with conditioned reflexes since the latter form the basis of more or less stereotyped action.

According to the degree of development of its extrapolatory reflexes, the animal is capable of solving problems of varying complexity. Experience has shown that an animal compelled to solve problems above its possibilities develops a nervous breakdown and sickness. Overstraining the extrapolatory reflexes results in neuroses.

---

## THE CHEMISTRY OF NUCLEIC ACIDS

T. R. SESHADRI

Department of Chemistry, University of Delhi

**N**UCLEIC acids are probably the most vitally important of natural polymers from the point of view of the living system. In several ways, their chemistry has been far more complex than that of other well-known polymers like polysaccharoses and proteins. That, in this difficult field, a stage of definite achievement has been reached at the present time is largely due to the great work of Prof. Sir Alexander Todd and his collaborators during the past fifteen years and this has been recognised by the recent award of the Nobel Prize to him.

### OCCURRENCE

The first isolation of a nucleic acid was made from pus cells and egg yolk in 1871 by Miescher. He found that they were usually associated with proteins and had to be liberated by means of alkali or enzymes. He noted also their marked acid property and insolubility in usual organic solvents. Many other sources of nucleic acids have subsequently been found, such as yeast, thymus gland and fish sperm. They are widely distributed in plants and animals and their existence in bacteria and viruses has considerable interest.

At one time it was thought that there was definite distinction between plant nucleic acids and animal nucleic acids and that the former was based on ribose and the latter on desoxyribose. The names Ribo Nucleic Acids (RNA) and Desoxyribo Nucleic Acids (DNA) were given to them. Later discoveries have shown that this is not so, and both types are found in plants, as well as in animals. But each is present in a different part of the cells; for example, the cytoplasm contains RNA, and the nucleus DNA; and each group has probably a different function to perform.

### ISOLATION

As already mentioned, the nucleic acids occur in combination with proteins (nucleoproteins)

intimately associated with the cells. The main stages in the isolation involve the destruction of the tissues, the separation of nucleic acids from proteins and finally precipitation and purification of the nucleic acids. For the first two stages sodium hydroxide in the cold or in the hot is employed and precipitation effected with hydrochloric acid. This works well for the preparation of yeast nucleic acid. The use of alkali has a great disadvantage, since the nucleic acid molecule is liable to break down during the treatment and hence alternative methods such as extraction with hot aqueous sodium chloride, heat denaturation and disruption by ultrasonic waves have been recommended. Their purification is extremely difficult and homogeneous preparations are rarely obtained.

### ANALYTICAL STUDIES

We owe a great deal to the pioneering and extensive work of Levene. As already mentioned, nucleic acids are large molecules made up of a number of smaller units called nucleotides. The conversion of nucleic acids into nucleotides is conveniently effected by mild hydrolysis, e.g., heating with dilute ammonia at 115° C. for 1 hr. These nucleotides occur free to some extent and they have been shown to be made up of three components, a purine or pyrimidine base, a sugar, and phosphoric acid. When treated with sodium hydroxide phosphoric acid alone is cleaved leaving the other two parts together, in what is called nucleoside (glycoside). Further acid hydrolysis liberates the free purine or pyrimidine base and D-ribose in the case of RNA and D-desoxyribose in the case of DNA.

The basic part of different nucleotides varies. It may either belong to the purine group such as adenine and guanine or to the pyrimidine group such as cytosine, uracil and thymine. The constitution of the purines and pyrimidines

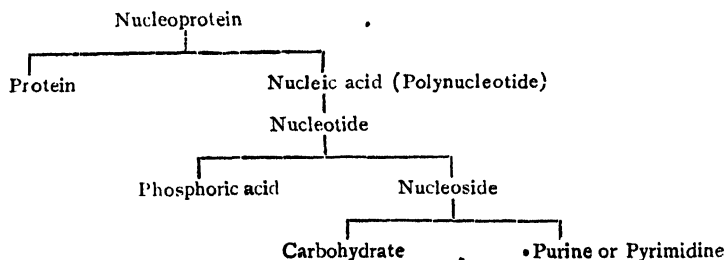

had been established earlier mainly by the work of Emil Fischer's school.

purines it was the 9 position and in pyrimidines the 3 position. In view of the close re-

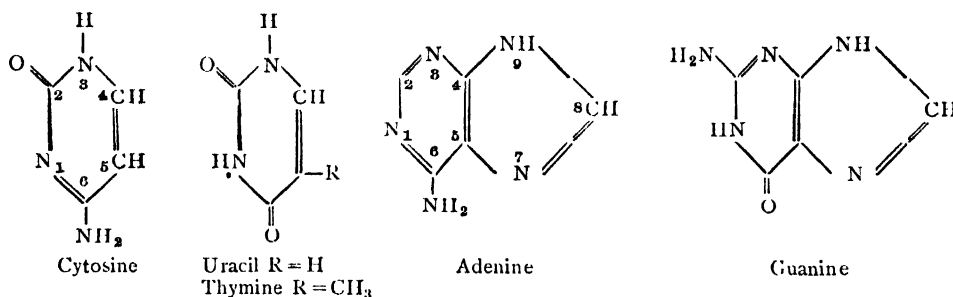

D-ribose and D-desoxyribose were first identified by Levene and Jacobs (1908-11) as hydrolytic products of nucleic acids. This was the first discovery of these sugars in Nature. Later they have been found to be present in other sources too. It is interesting to note that D-ribose was known much earlier as a synthetic product, synthesised by Emil Fischer in 1901, in the course of his study of carbohydrates. He also synthesised desoxyribose in 1913. These are probably two of the most important carbohydrates occurring in Nature. In 1935, Levene and Tipson showed that these sugars are linked with the bases in the form of glycosides and the rate of hydrolysis of the nucleosides is like those of other glycosides. They also showed that in the combination they exist in the furanose ring form. This information was obtained by complete methylation and hydrolysis. The resulting trimethyl ribose yielded dimethyl tartaric acid on oxidation. Later on, Todd and his co-workers used periodic acid titration and showed that in ribonucleosides there are only two hydroxyl groups in the neighbouring positions thus confirming the furanose structure. This is a handy method of diagnosis of the ring structure present in natural as well as synthetic ribosides and has also been ingeniously used for determining the  $\beta$ -configuration of the glycosidic linkage.

Though the nature of the ultimate units composing the nucleic acids was known fairly early, there has been considerable difficulty in finding out the precise manner in which these are linked together to constitute the nucleosides, the nucleotides and eventually the nucleic acids. First there was the question regarding the position of linking of the purines and the pyrimidines with the sugars. Gulland and co-workers studied this problem by comparing the ultra-violet absorption spectra of the natural ribonucleosides with those of synthetic alkyl substituted bases and concluded that in

semblance between the ribose and desoxyribose derivatives the same positions have been considered to be occupied by the desoxyribose units also.

#### SYNTHETIC WORK

As already mentioned, the discovery of nucleic acids was made more than eighty years ago. However, it is only during the last decade that definite progress in the study of their structures has been possible. This long delay was due to the lack of precise knowledge of the structure and properties of the simple nucleosides and nucleotides, formed as products of hydrolysis. A marked difference exists between nucleic acids and other well-known high polymers occurring in Nature. In carbohydrates and proteins, the monomers are bifunctional simple entities like mono-saccharoses and amino acids. In the case of nucleic acids, the nucleotide monomers consist of three different parts and the inter-linkages were difficult to establish. Further, other difficulties existed, *e.g.*, the nucleotides which are polar substances are insoluble in common organic solvents and are very difficult to handle by the classical methods of organic chemistry. The intensive development of nucleotide chemistry had therefore to await the introduction of new experimental techniques. The important synthetic studies can be considered under three heads.

#### STRUCTURE AND SYNTHESIS OF NUCLEOSIDES

The total synthesis of the four ribonucleosides was a great achievement and established their structure. For the synthesis of purine nucleosides a possible route was that of Emil Fischer in which the silver salt of the purine is made to react with an aceto-halogeno-sugar. This method required the unknown (at that time) aceto-halogenoribofuranose and was not unambiguous as regards the location of the sugar residue in the product obtained. A new type of synthesis was therefore developed by Todd

and his co-workers. It involved the preparation of a glycoside of a pyrimidine, with subsequent completion of the purine nucleus by building up the second ring. Though this method needed long and difficult exploration, it was successfully developed leading to the final synthesis of adenosine. The essential stages are outlined below:

2:8-dichloro-9-β-D-ribofuranosidyl adenine (III, R = ribose unit). Removal of the chlorine atoms by hydrogenation yielded adenosine (I).

Partial reduction of dichloro compound (III, R = ribose unit) to 2-chloroadenosine followed by deamination with nitrous acid and replacement of the chloro group by amino, gave guanosine (IV, R = ribose).

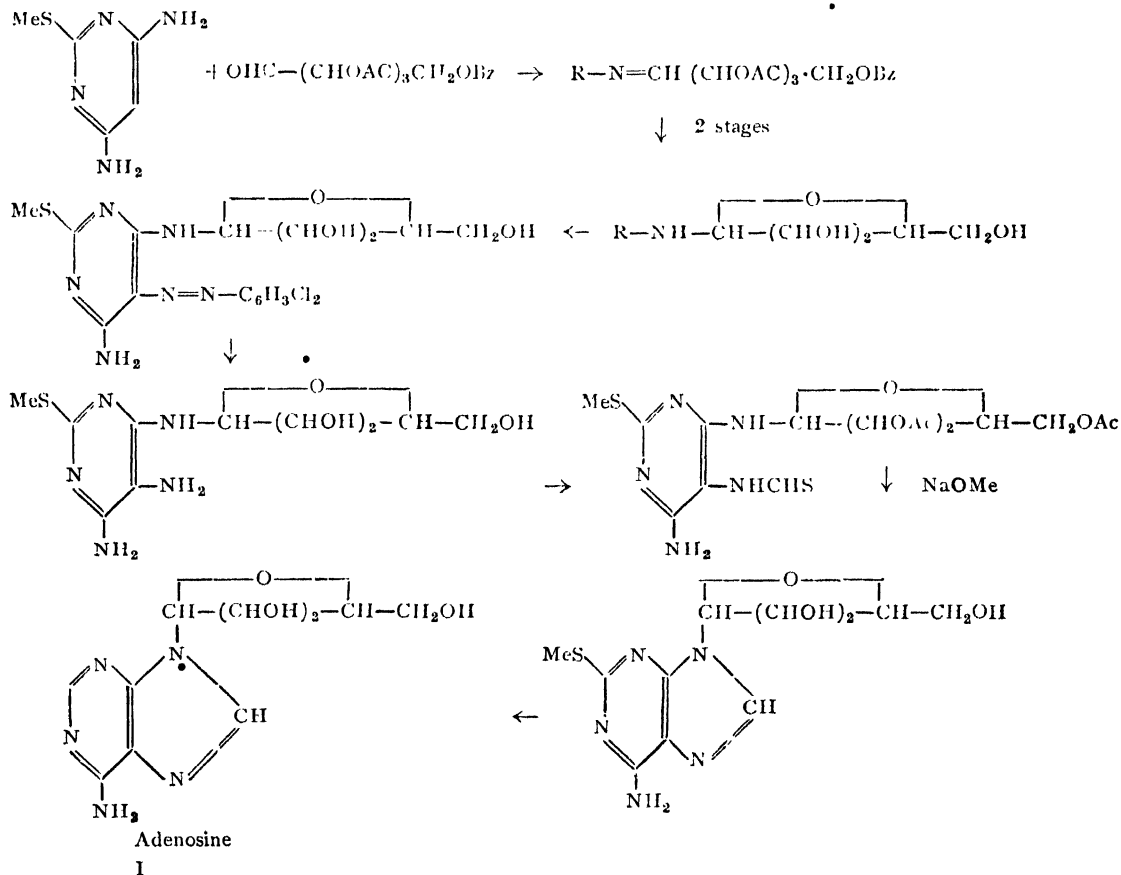

Adenosine (I) was also synthesized by an extension of Fischer's method. Acetochlororibofuranose (II) prepared from 5-trityl ribose was treated with silver 2:8-dichloroadenine (III, R = Ag) and the product deacetylated, giving

For the synthesis of cytidine (VI b), acetobromoribofuranose (II, X = Br) was treated with 2:6-diethoxypyrimidine (V a). This involves a reaction characteristic of heterocyclic compounds in which quaternary ammo-

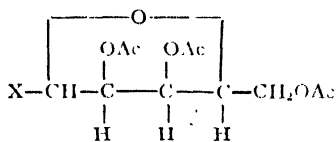

II X=Cl or Br

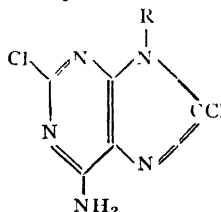

III

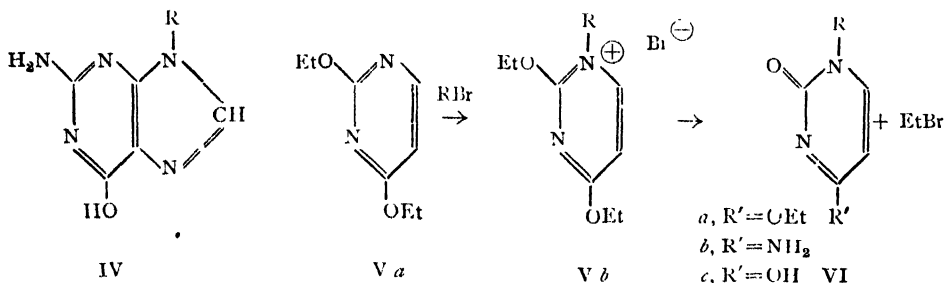

nium salts (V b) undergo conversion into dihydroderivatives. The stages are indicated in the formulæ given above. Treatment of the product with ammonia gave cytidine (VI b). Uridine (VI c) could be obtained by deamination of cytidine with nitrous acid.

They are in each case  $\beta$ -D-ribofuranosides, the sugar residue being attached at N-9 in the purine and at N-3 in the pyrimidine units respectively. The  $\beta$ -form is the stablest and tends to be formed easily; this is attributed to the favourable influence of the basic nitrogen atom to which the sugar group is attached. Similar structures hold good for the desoxyribonucleosides also, though their synthesis has not so far been effected, largely due to the unavailability of desoxyribose.

#### PHOSPHORYLATION OF NUCLEOSIDES (NUCLEOTIDE SYNTHESIS)

Thirty years ago Levene established by titration studies that the nucleic acids were made up of nucleoside units linked together by phosphate residues. He also demonstrated that ether and pyrophosphate linkages were absent. However, no further progress could be made because of the lack of detailed knowledge of nucleosides and the chemistry of the esters of phosphoric acid. Before 1949, it was generally held that ribonucleic acid (RNA) yielded on alkaline hydrolysis only four simple nucleotides (adenylic acid, guanylic acid, uridylic

acid and cytidylic acid) believed to be 3'-phosphates. Using ion-exchange chromatography, Cohn showed during this year (1949) that the hydrolysates really contained 8 simple nucleotides made up of four pairs of isomers. By that time Todd and his co-workers had been devising methods for the unambiguous synthesis of mononucleotides of adenosine, guanosine, uridine and cytidine. Earlier methods of phosphorylation were unsatisfactory. An efficient method should proceed in good yields under mild conditions and no hydrolytic process should be involved which might damage sensitive glycosides. They found by extensive study that dibenzyl chlorophosphonate serves the purpose best. This substance reacts readily with alcohols at room temperature in the presence of tertiary bases yielding esters of type (VII). From these products the benzyl groups can be removed smoothly by catalytic hydrogenation.

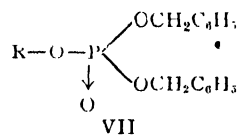

The 5'-phosphates were obtained by the phosphorylation of the 2':3'-isopropylidene derivatives of the nucleosides followed by the removal of the protecting groups.

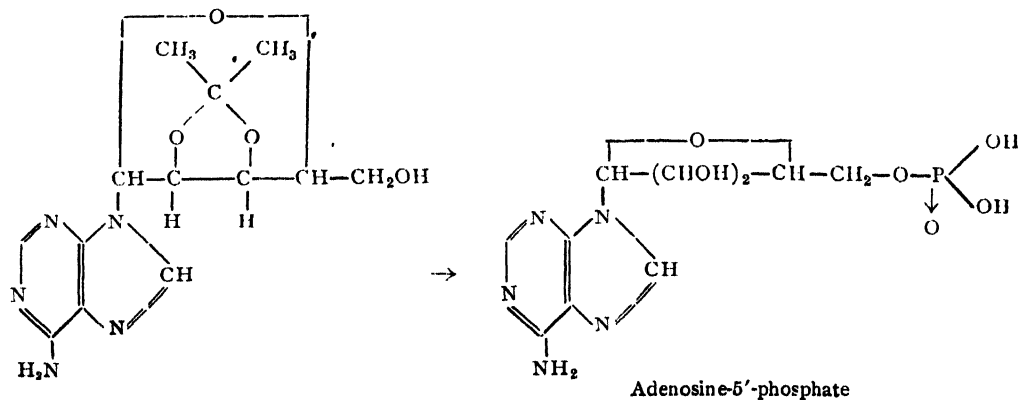

Subsequently Brown and Todd synthesised adenosine-2', and adenosine-3'-phosphates by phosphorylating 5'-trityladenosine and separating the mixture of products by ion-exchange chromatography. They were identical with the adenylic acids -a and -b of Cohn, but which was the 2' and which the 3' it was impossible to say with certainty. This was first indicated by the hydrolysis of the isomers with an acid ion-exchange resin. The former yielded a product which was identified as the 2'-phosphate and the latter the 3'-phosphate of ribose. Confirmation was provided by the partial acetylation of 5'-acetyl adenosine to 3': 5'-diacetyl derivative, the phosphorylation of which followed by deacetylation yielded adenylic acid-a alone; it should therefore be 2'-phosphate of adenosine and adenylic acid-b should therefore be 3'-phosphate. This point has also been established by X-ray crystallographic methods.

phate considered to be an intermediate. The process of hydrolysis is indicated in the following scheme and the peculiar reaction is attributed to the presence of a *cis*-hydroxyl group in the concerned system.

The structural analogy between these nucleotide mono-esters and poly-nucleotides was recognised by Brown and Todd and they used it to explain the ready alkaline hydrolysis of RNA and the stability of DNA (which do not have the 2'-hydroxyl) under same conditions. They also advanced the general formulation of both types of nucleic acids as 3'-5'-linked polynucleotides.

#### FORMATION OF POLYNUCLEOTIDES

The general structures at present accepted for DNA and RNA are indicated in formulæ (VIII) and (IX). In these representations the sugar part intimately connected with the inter-

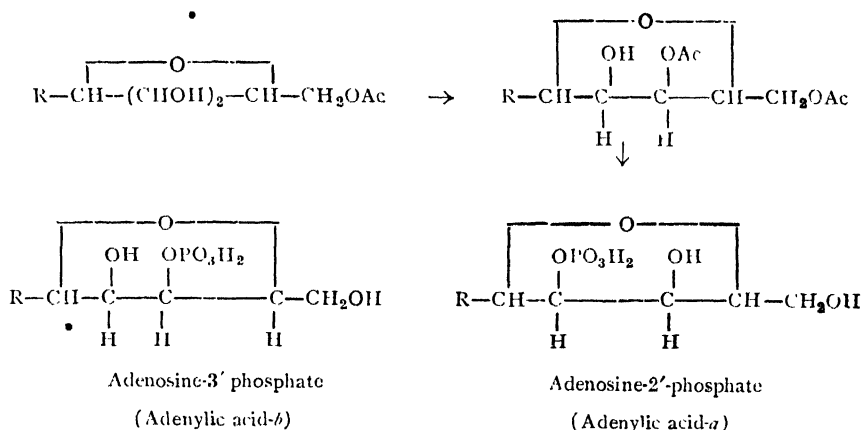

Explanation of the results of Cohn who obtained pairs of phosphates of each nucleoside was provided by the study of the migration of the phosphate groups. A significant observation was the lability of nucleotide mono-esters towards alkali. These undergo hydrolysis readily and yield mixtures of the unesterified 2' and 3'-phosphates along with a cyclic 2'-3'-phos-

nucleotide linkage and bearing free hydroxyl groups alone is specified. In the case of DNA evidences are derived from the stability towards alkali and the course of enzymic and acid hydrolysis. In regard to RNA definite proofs have been more difficult to obtain but they have been provided by studying the action of specific enzymes on these nucleic acids.

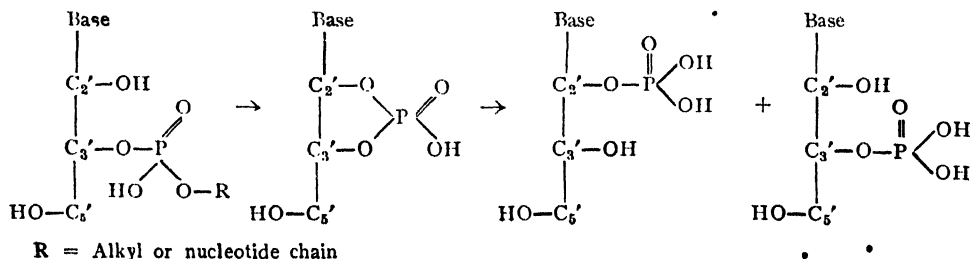

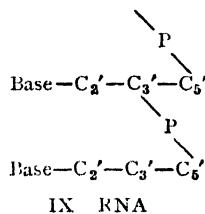
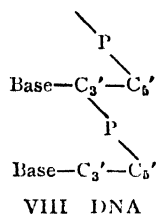

The linear structures represented above for both types of nucleic acids are in accord with their properties and X-ray evidence. Individual nucleic acids may be expected to differ substantially in the sequence of the nucleotide residues and hence methods of sequence determination are necessary in order to have a complete picture. In the analogous case of polypeptides stepwise degradation from an end has been successfully employed for this purpose. But the problem is far more difficult in nucleic acids because of the greater instability of the phosphate linkages. An interesting method has been suggested by Todd and co-workers for the study of ribonucleic acid. This involves the use of periodate fission which will affect only one end group and subsequent elimination; the method has already been applied with success to small oligo-nucleotides.

As the next step the conformation of nucleic acid macromolecules could be considered; this has received a great deal of attention. Salts of DNA can be obtained in crystalline fibre form and are quite suited for X-ray studies. They appear to have the form of a double helix. According to Watson and Crick (1953) they exist as a kind of double molecules consisting of two polynucleotide chains in the form of right-handed helices coiled round the same axis and held together by hydrogen bonds. The phosphate groups are on the outside and the purine and pyrimidine bases lie inside the helix at right angles to the long axis. An important feature is that the purine and pyrimidine bases are not at random but are hydrogen-bonded in specific pairs. A third coaxial chain is present in nucleo-proteins and seems to be formed by the polypeptide chain of the protein component.

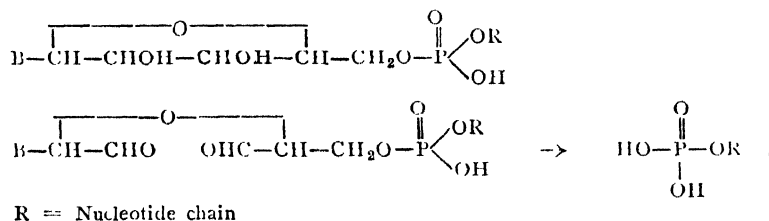

An alternative procedure for getting this information will be stepwise synthesis. This has also been shown to be possible. Michelson and Todd have synthesised a dithymidine-dinucleotide containing the 3'-5'-inter-nucleotidic linkage and have shown that the behaviour of the synthetic material towards enzymes is exactly the same as that of dinucleotidic fragments obtained by degrading desoxyribonucleic acids.

Another important recent discovery is that of Ochoa (1955) that an enzyme system can rapidly synthesise polynucleotides from nucleoside 5'-pyro-phosphates with the elimination of orthophosphate. This is akin to the technical production of fibre-forming poly esters and lends support to the view that the monomers involved in the formation of natural nucleic acids are nucleoside 5'-phosphates.

This picture seems to offer an important clue to the way in which hereditary patterns are passed on during cell division and also how mutation can take place. DNA being characteristic components of chromosomes seem to play a vital part in heredity transmission. They have a key function in controlling the synthetic processes in the cell and this is obviously related to protein synthesis. This function seems to be carried out through the help of the RNA which occur largely in the cytoplasm. Thus the three, DNA, RNA and protein, seem to be closely related. Todd has suggested a mechanism of specific protein synthesis based in the Watson-Crick model and the known behaviour of mixed anhydrides. According to this the nucleic acid macromolecule should serve as a template to guide and facilitate the synthesis of specific proteins.

## SYMPOSIUM ON THE MONSOONS OF THE WORLD

**A** THREE-DAY Symposium on the Monsoons of the World, organised jointly by the International Association of Meteorology and Atmospheric Physics of the International Union of Geodesy and Geophysics, the World Meteorological Organisation and the Government of India, was held from the 19th to 21st February 1958, at New Delhi. It was inaugurated on the 19th February by Dr. K. S. Krishnan, Director of the National Physical Laboratory, India and Vice-President of the International Council of Scientific Unions. More than 300 scientists directly or indirectly interested in Meteorology were present. Dr. K. R. Ramanathan was elected Chairman.

The timing of the Symposium was adjusted so as to make it follow immediately the Second Session of the Commission for Synoptic Meteorology of the World Meteorological Organisation, which was held at Delhi between January 21 and February 17, 1958. This enabled the delegations of many nations, who had attended the Meetings of the Commission for Synoptic Meteorology, to stay on for the Symposium and participate in its proceedings.

The delegates were welcomed by Dr. K. R. Ramanathan, Convener of the Organisation Committee of the Symposium.

Dr. Krishnan in his inaugural speech emphasised the need for the holding of such symposia on subjects of wide interest, for better promotion of all scientific work in general, and

of scientific work in the earth sciences in particular.

The officers of the Indian Meteorological Department had to put forth intense effort to organise the Symposium at very short notice.

Prof. H. Flohn of the Meteorological Service of the Federal Republic of Germany was the only invited expert who could participate in the Symposium. His papers were thought-provoking, particularly his arguments that the monsoon of India has worldwide connections and was an important part of the general circulation of the atmosphere.

The Symposium lasted for full three days. Thirty-four papers falling under the following seven headings: (1) Climatology of the Monsoons—Surface and Upper Air; (2) Monsoons and the General Circulation; (3) Dynamics of the Monsoons; (4) Depressions and Other Perturbations in the Monsoon; (5) Rain and Clouds of the Monsoons; (6) Variability of the Monsoons; (7) Forecasting of the Monsoon—Extended and Long Range, were received. Discussion followed presentation of papers in groups. It was the general feeling that the deliberations of the assembled meteorologists led to better understanding of the phenomena of the monsoons in Asia, Africa and Australia. The Symposium came to a close at 6-30 p.m. on February 21, with a vote of thanks from Dr. P. R. Pisharoty, the Secretary of the Organising Committee. P. R. P.

## A REMARKABLE SOLAR RADIO EVENT

**O**N November 4, 1957, a large increase in solar radio noise was observed on a frequency of 200 Mc./s. at the receiving station 'Nera' of the Netherlands Telecommunications Services. The increase started rather abruptly at 0848 U.T. and lasted for more than 5 hrs., the greatest intensity being reached at about 0930 U.T., when it amounted to approximately 900 times the noise level of the quiet Sun. The smoothed intensity level showed considerable fluctuations with periods of the order of a few minutes. No solar flare has been reported as occurring near the onset of the radio event, nor was a sudden ionospheric disturbance observed. The phenomenon manifested itself over a considerable frequency-range in the metre wavelength band.

The lack of correlation with a solar flare or associated effects, and the absence of disturbances on the decimetre-centimetre wavelengths, must be considered as rather exceptional for so large a 200 Mc./s. event. However, the extra-

ordinary character of this radio phenomenon was particularly apparent from records obtained with a negligible time-constant.

No ionospheric scintillation of radio sources of any importance was observed at the Jodrell Bank Experimental Station or at the Mullard Radio Astronomy Observatory on November 4. Ionospheric scintillations of so short a period have never, in fact, been observed in Cambridge (Dr. A. Hewish, Private communication). The very short-period fluctuations of intensity must also, therefore, be ascribed to solar conditions.

All these facts together justify the conclusion that the radio phenomenon which occurred on November 4 is of a new, so far unknown type of great rarity. It should be noted that this peculiar type of variability is revealed only by a recording instrument with a time-constant no greater than a very small fraction of a second. (*Nature*, Vol. 181, 542, 1958.)



## OBITUARY: PROFESSOR M. DAMODARAN

BY the death of Professor M. Damodaran last December, Biochemistry lost one of its great pioneers. He had long been recognised as a leading Biochemist in India. He was educated at the Presidency College, Madras. After a brilliant academic career he received preliminary training in research at the Indian Institute of Science, Bangalore. The award of a research scholarship by the Government of Madras enabled Damodaran to continue his studies in Germany and England. In Germany (1928) he had the unique privilege of working with Abderhalden—the father of Protein Chemistry—on the preparation and enzymic digestion of myristic acid peptides. Later, under the inspiring leadership of Professor A. C. Chibnall, Imperial College of Science and Technology, London, he continued the work in the domain of Protein Chemistry. During 1929-32, he established the first direct proof of the 'Amide Hypothesis' in proteins, by isolating asparagine and glutamine from enzymic digests of edestin and gliadin respectively. This remarkable contribution gained him the Degree of D.Sc. (London).

Returning to India towards the close of 1932, he was appointed first Reader of Biochemistry at Madras University. Subsequently, he became Professor and held the post till 1948, when he was invited to assume Directorship of the Biochemical Division at the National Chemical Laboratory, Poona (then temporarily housed at Delhi). Later, he assumed the Deputy Directorship of the Laboratory and his retirement due to ill-health in the middle of 1956 was very much regretted by all his colleagues.

Professor Damodaran's scientific publications are legion and cover a wide range of problems

in Biochemistry. Demands on brevity restrict one from presenting a detailed account of his work. During the thirties one notices his work on proteins from seeds, *viz.*, cashew-nut, water-melon seeds, canavanine from *Canavalia obtusifolia*, isolation of L, 3:4-dihydroxy-phenyl alanine from the seeds of *Mucuna pruriens*, enzymic proteolysis, amino acids of casein phosphopeptone. He demonstrated for the first time the presence of glutamic dehydrogenase in germinated seedlings. This was followed up by his finding succinic dehydrogenase in germinated seedlings.

Though a Protein Chemist at heart, Professor Damodaran gave prominence to problems having economic or medical application—in keeping with the need of the day. To this difficult and exacting task he has given freely and unstintingly of his time, of his vast store of experience and of himself. He bred a remarkably active strain of *Aspergillus niger* for the production of citric acid from sugar. Another notable achievement is his synthesis of ascorbic acid from sorbitol, with a 99% intermediary yield of sorbose. His gelatin plasma substitute preparation, based on a tryptic digestion, is undoubtedly his most spectacular contribution towards alleviation of human suffering. This has been clinically tested with excellent results.

Professor Damodaran was an expert analyst. He brought his great scientific skill and precision to bear on methods of separation, isolation and identification in the immensely complicated chemistry of living matter. His students, and all who knew him will mourn the loss of this truly great leader in science.

K. RAMAMURTI.

---

 THE PROPERTIES OF THROMBINOGEN

IN a paper that has appeared in *Canadian Journal of Biochemistry*, Vol. 36, 75, 1958), evidence is given which demonstrates the existence of an intermediate, designated thrombinogen, during the conversion of prothrombin to thrombin. The conversion of prothrombin to thrombin requires thrombin, though other tryptic enzymes can replace thrombin. The properties of thrombinogen have been studied.

As a result of observations on the properties of thrombin the author suggested that an in-

termediate, designated thrombinogen, is formed during the conversion of prothrombin to thrombin. Shulman and Spaet on independent grounds, also recognized the inadequacy of a simple conversion of PT to T. The validity of the proposal has now been demonstrated. As a guide to isolation attempts, the studies reported were undertaken to determine some of the chemical and physical characteristics of this intermediate.

---

LETTERS TO THE EDITOR

AN EMPIRICAL FORMULA FOR THE  
MASSES OF THE ELEMENTARY  
PARTICLES

THE  $\pi^\pm$  meson has a mass of  $273 m_e$ , where  $m_e$  is the mass of the electron. It has previously<sup>1</sup> been pointed out that this value is very nearly twice the reciprocal of the fine structure constant,  $\alpha$ . Thus

$$\pi^\pm = 2/\alpha = 2(137) = 274 \quad (1)$$

Similarly, the  $\mu^\pm$  meson has a mass of  $207 m_e$ , which is very close to the value

$$3/2\alpha = 3(137)/2 = 206 \quad (2)$$

Among the hyperons (the elementary particles heavier than the neutron), the mass of the  $\Lambda^0$  particle is  $2181 m_e$ , that of the  $\Sigma^\pm$  particles is  $2327 m_e$ , and the mass of the  $\Xi^-$  particle, the heaviest known elementary particle, is  $2586 m_e$ . Now we find, quite astonishingly, that these masses are related to the mass of the proton ( $= 1836 m_e$ ) in the following manner:

$$\Lambda^0 = p + \mu + 1/a = 1836 + 207 + 137 = 2180 \quad (3)$$

$$\Sigma^\pm = p + \mu + 2/a = 1836 + 207 + 2(137) = 2317 \quad (4)$$

$$\Xi^- = p + \mu + 4/a = 1836 + 207 + 4(137) = 2591 \quad (5)$$

These relations suggest that a hyperon intermediate in mass between the  $\Sigma$  and  $\Xi$  particles, with mass 2454 and as yet undiscovered, might be capable of existence:

$$p + \mu + 3/a = 2454 \quad (6)$$

Taking the foregoing relationships into account, the following formula, which permits the calculation of essentially all the known elementary particle masses,<sup>2</sup> can be derived:

$$M = n_1 M_0 + (n_3 + \frac{3}{2} n_2 - \frac{9}{2} n_1) / \alpha \quad (7)$$

In this equation,  $M$  is the desired elementary particle mass,  $M_0 = 2454$ ,  $\alpha = 1/137$ , and  $n_1$ ,  $n_2$  and  $n_3$  are small integers or zero, and these may therefore be called "mass quantum numbers".

Equation (7) can then be written

$$M = 2454 n_1 + 137 \left( n_3 + \frac{3}{2} n_2 - \frac{9}{2} n_1 \right) \quad (7a)$$

Table I gives the values which these integers must have in order to reproduce the elemen-

tary particle masses. The results of the calculation and the observed values of the masses are also shown in the table.

TABLE I

The integer values of the "mass quantum numbers" and the masses of the elementary particles as calculated from Eq. (7a)

Particle	$n_1$	$n_2$	$n_3$	Calc. Mass	Obs. Mass
$\mu^\pm$	0	1	0	206	207
$\pi^\pm (\pi^0)$	0	0	2	274	273 (264)
$\tau^\pm (\nu^0)$	0	2	4	951	966 (965)
$p^\pm (\nu^0)$	1	0	0	1837	1836 (1830)
$\Lambda^0$	1	1	1	2180	2181
$\Sigma^\pm$	1	1	2	2317	2327
$\Xi^-$	1	1	4	2591	2586

For the known particles,  $n_1$  has only two values, 0 and 1, and is seen to be identical with the so-called baryon number;  $n_2$  has three values, 0, 1 and 2, and it is interesting to note that all four particles having  $n_2 = 1$  have also the same spin<sup>3</sup> ( $1/2$ );  $n_3$  takes on four different values, 0, 1, 2 and 4, and it should be noted that particles having the same value for  $n_3$  have also the same value for the Z component of isotopic spin ( $T_z$ ).

The existence of additional particles, as yet unobserved, may possibly be capable of prediction by selecting other combinations of the mass quantum numbers.<sup>4</sup>

Stevens Inst. of Technology,  
Hoboken, N.J., U.S.A., January 3, 1958.

LEONARD S. LEVITT.

1. Nambu, Y., *Progr. Theoret. Phys.*, 1953, **10**; also Yo-hikawa S. and Hasebe, T., *Ibid.*, 1953 **10**, 359, and 1954 **11**, 496; also Ueatsa, H., *Ibid.*, 1954, **11**, 125 and 1955, **12**, 363.
2. The  $\pi^0$  meson and neutron have masses very close in value, respectively, to the  $\pi^\pm$  mesons and proton, as shown in parenthesis in Table I.
3. In this regard the  $3/2$  coefficient of  $n_2$  in Eq. (7) is suggestive.
4. In this connection it is interesting to note that when  $n_1 = 0$  and  $n_2 = 4$ , or  $n_2 = 2$  and  $n_3 = 1$ , a particle of mass 548 is predicted; and Alikhanian has recently reported the detection of particles of mass 550, (Alikhanian et al., *Zhur. Ekspit. i Teoret. Fiz.*, 1956, **31**, 955.)

**DETERMINATION OF BLOOD MEALS  
OF INDIAN *CULICOIDES* (CERATOPO-  
GONIDÆ : DIPTERA)**

*Culicoides* have been known to feed not only on mammals but occasionally also on birds, reptiles and even on insects (Hill, 1947). Information on the nature of feeding in Indian *Culicoides* is however very meagre. Some observations are no doubt on record but there is a considerable lack of unanimity. Kieffer (1910), Macfie (1932) and Mukerji (1931) report that the *Culicoides* investigated by them were mostly cattle-blood feeders, whereas Edwards (1932) and Smith (1929) consider a few among them as feeders on human blood. One species, *C. oxystoma* has also been recorded as feeding on earthworms (Patel, 1922), while *C. anophelis* has been variously reported as feeding on mosquitoes (Das Gupta and Ghosh, 1957).

*Culicoides* with typical piercing mouth-parts appear ideally suited for feeding on animals or man, but in actual habit they have not conformed to this on more occasions than expected. We therefore undertook some analytical tests of the stomach fluid of the insects with precipitin sera, and also induced them to feed under laboratory conditions on small rodents and man to find out their feeding preferences, if any. Altogether 15 species have been examined (*C. anophelis*, *C. peregrinus*, *C. palpifer*, *C. alatus*, *C. macfei*, *C. similis*, and nine undescribed ones).

The observations so far carried out indicate that nearly all the species locally available readily take to cattle blood and as large a number as 13 species (including all the described species excepting *C. anophelis*) proved positive for cattle blood in precipitin tests. *C. anophelis* did not react to anti-human or anti-ruminant sera although they were taken from engorged mosquitoes in cattle sheds or human habitations. This however does not preclude the possibility of the species drawing mammalian blood from host insects and an extremely rare incidence, of the species feeding directly on cattle has also been described (Smith and Swaminath, 1932). In the absence of positive evidence ascribing the nature of the feed this species resorts to, we are inclined to believe that the chief source of nourishment of *C. anophelis* is the hæmocœlic fluid of the mosquitoes parasitised, as has also been expressed by Iyengar (1938). In the mode of feeding on mere hæmocœlic fluid, as it emerged now, the species exhibits another character in support of the view that *C. anophelis* represents one of the primitive forms

under the genus, for according to Edwards (1923) it is only the primitive *Culicoides* that feed on the body fluid of insects.

The only evidence of a *Culicoides* feeding in nature on human blood as confirmed by precipitin tests in our observations is afforded by a species which appears to be a new species. We hope to describe the species soon elsewhere.

School of Tropical  
Medicine, Calcutta,  
November 21, 1957.

P. SEN,  
S. K. DAS GUPTA.

1. Das Gupta, S. K. and Ghosh, S. M., *Bull. Calcutta Sch. Trop. Med.*, 1957, **5**, 26.
2. Edwards, F. W., *Ann. Trop. Med. Parasit.*, 1923, **17**, 19.
3. —, *Rec. Indian Mus.*, 1932, **34**, 177.
4. Hill, M. A., *Ann. Trop. Med. Parasit.*, 1947, **41**, 55.
5. Iyengar, M. O. T., *Proc. Nat. Inst. Sci. India* 1938, **4**, 237.
6. Kieffer, J. J., *Mem. Ind. Mus.*, 1910, **2**, 181.
7. Macfie, J. W. S., *Ann. Mag. n. II.*, 1932, **9** (10), 485.
8. Mukerji, S., *Ind. J. Med. Res.*, 1931, **18**, 1051.
9. Patel, P. G., *Proc. 4th Entom. Meeting, Pusa*, 1922, 277.
10. Smith, R. O. A., *Int. J. Med. Res.*, 1929, **17**, 255.
11. — and Swaminath, C. S., *Indian Med. Res. Mem.*, 1932, **25**, 185.

**APPARENT MOLAR VOLUMES AND  
AGGREGATION OF BARBITURATES**

IN the course of a study of apparent molar volumes of electrolytes in solution extended to organic ions, it is found that the variation of this property with concentration shows a departure from general behaviour in the case of some of the 5, 5 substituted sodium barbiturates, probably indicative of a change in their state of aggregation in aqueous solution with change in concentration. Precision measurements of the densities of aqueous solutions of the following sodium salts were carried out at various concentrations over the range 0.05 to 0.8 molar at 25° C. by the method of Parker and Parker.<sup>1</sup>

(I) 5, 5 diethyl barbiturate. (II) 5-ethyl 5-isopropyl barbiturate. (III) 5-ethyl 5-(1) methyl-butyl barbiturate. (IV) 5-ethyl 5-isopropyl barbiturate. (V) 5-allyl 5-(1) methyl-butyl barbiturate. The density  $d_m$  at molality  $m$  is expressed in the form  $d_m = d_0 + am + bm^2 + cm^3$  where  $d_0$  is density of water at 25° C. and the values of  $a$ ,  $b$  and  $c$  given below hold over the concentration range studied.

TABLE I  
Density at 25° C. as a function of molality coefficients

Solute		<i>a</i>	<i>b</i>	<i>c</i>
I	..	0.07641	-0.01708	0.00503
II	..	0.07599	-0.01413	0.00222
III	..	0.07224	-0.01865	0.00535
IV	..	0.06894	-0.01664	0.00503
V	..	0.07332	-0.01380	-0.00012

Masson has proposed the following relation for the apparent molar volume  $\phi(V_2)$  (the difference between the volumes of solution and of solvent containing one mole of solute) which represents the concentration dependence of apparent molar volume of a wide variety of electrolytes<sup>2</sup>:

$$\phi(V_2) = \phi_0(V_2) + a\sqrt{c}$$

where  $\phi_0(V_2)$  and *a* are constants and *c* is concentration of solute in mole per litre. The variation in apparent molar volumes of the barbiturates considered here, calculated from the above density data, is represented in figure where  $\phi(V_2) - \phi_0(V_2)$  values are plotted against  $\sqrt{c}$ . These values show a regular linear rise

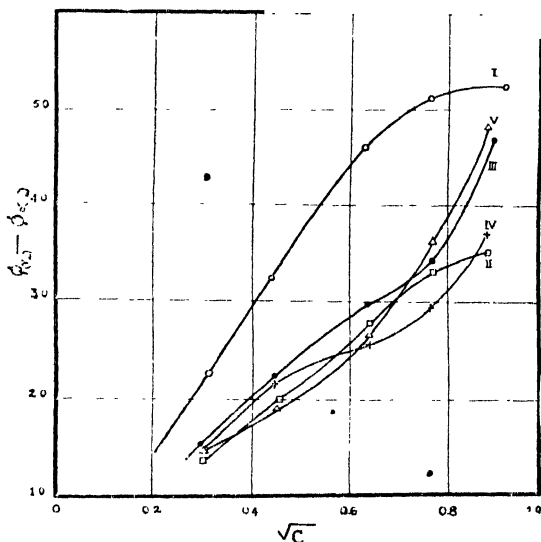

FIG. 1

for all the barbiturates up to about 0.5 molar concentration as fits Masson's equation; but at higher concentrations the curves of I and II tend to level off to a flat while the curves of III, IV and V show a steep rise. This marked increase in apparent molar volumes of the latter three closely resembles the behaviour of

potassium *n*-octoate in solution investigated by Davies and Bury.<sup>3</sup> It has been suggested that the lack of affinity between the hydrocarbon chain and water normally leads to the curling up of long chain molecules to minimize hydrocarbon/water interface subjecting them to considerable compression. If the molecules aggregate together at any stage, the surface energy will be lessened and the compressive pressure released causing an increase in the partial volume of the solute.<sup>4</sup>

The marked rise in apparent molar volume indicated by III, IV and V in the region 0.5 to 0.6 molar, viewed in relation to their longer chain substituents in 5, 5 position as compared to I and II seems to bear out the above suggestion and it appears that aggregation of the organic ions of III, IV and V occurs at the concentration indicated.

Chemistry Dept.,  
Sri Venkateswara University,  
Tirupati, December 24, 1957.

V. R. KRISHNAN.

1. Parker, H. C. and Parker, E. W., *J. Phys. Chem.*, 1925, **29**, 132.
2. Masson, D. O., *Phil. Mag.*, 1929, **8**, 218.
3. Davies, D. G. and Bury, C. R., *J. Chem. Soc.*, 1930, 2263.
4. Alexander, A. E. and Johnson, P., *Colloid Science*, 1949, **2**, Oxford University Press, 687.

### PRESENCE OF PROPOLIS IN THE PROTHORACIC SPIRACLES OF *APIS FLOREA* FAB.

WHILE engaged in the study of the respiratory system of some Hymenoptera, the presence of propolis in the prothoracic spiracles of *Apis florea* was detected. Propolis is a resinous material collected by the domestic bees from plants. The bees examined are from two different localities as (i) Mahabaleshwar, and (ii) Kopargaon from Bombay State. The prothoracic spiracles of this species have an operculate closing mechanism as described by Snodgrass<sup>2</sup> (1956) and Wohlegmuth<sup>1</sup> (1929). The spiracular opening measures on an average .09 mm. in length and .06 mm. in breadth. The operculum which covers this opening is .14 mm. long and .07 mm. broad. Diameter of the trachea which widens as it leaves the spiracle is approximately .12 mm. The size of the brown mass of propolis based on the measurements of over 30 specimens is .11 mm. in breadth and .1 mm. in length. Judging from the size of the trachea and the size of the propolis it can be readily appreciated that the latter prevents partially, if not completely, the entry of air

into the body of the bee. The presence of propolis in the anterior thoracic spiracles of *Apis florea* is recorded here for the first time. It is interesting in the view of the fact that blocking of the corresponding spiracles with wax in *Apis mellifera* L. results in the total loss of the power of flight according to White<sup>3</sup> (1924). He attributed similar effects when the prothoracic spiracles are severely infested with the mite *Acarapis woodi* (Rennie). But in *Apis florea* such a blocking does not seem to have affected their power of flight. This is so because the second thoracic spiracles serve as an alternative mechanism to provide thorough ventilation in the thorax, a region of relatively high carbon dioxide production. Bailey<sup>1</sup> (1954) ignored the second thoracic spiracles of *Apis mellifera* as functionally unimportant because of their exceedingly small size. But in *Apis florea* the second thoracic spiracles are functional and account for the retention of the powers of flight.

Acknowledgement is due to the Ministry of Education, Government of India, for the award of National Research Fellowship. I am indebted to Dr. S. P. Agharkar, Director, M.A.C.S. Laboratory, for extending the necessary facilities and encouragement. The bees were provided through the kindness of Shri K. V. Tonapi of Apicultural Laboratory, Mahabaleshwar.

M.A.C.S. Laboratory, G. T. TONAPI.  
Law College Buildings,  
Poona-4, December 17, 1957.

1. Bailey, L., *J. Expt. Biol.*, 1954, **31**, 589.
2. Snodgrass, R. E., *Anatomy of the Honey Bee*, Ithaca, New York, 1956, p. 334.
3. White, P. B., *Trans. Roy. Soc. Edinb.*, 1921, **52**, 755.
4. Wohlgemuth, O. E., *Erlanger Jb. Bienc.*, 1929, **7**, 1-46.

### THE REGULATION OF PETAL NUMBER

IN 1955-56, I examined 76,753 flowers from three plants of *Nyctanthes arbor-tristis*. The gamopetalous flowers are shed nightly and daily collections were made from 26-9-1955 to 11-1-1956. The number of petals varied from 4 to 9 with a high mode at 6. The totals for the three trees are given in Table I.

TABLE I

Total number of flowers with different numbers of petals for three trees

Petal number	4	5	6	7	8	9
Number of Flowers	134	10,975	55,732	9,431	471	8

The mean petal numbers for the three trees were  $5.924 \pm 0.0030$ ,  $6.050 \pm 0.0030$ , and  $5.984 \pm 0.0050$ . The second differs significantly from the others. It will be seen that 72.6% of all the flowers had the "standard" number of 6 petals. In most earlier work on variation of petal number<sup>3,4,5,11</sup> only a minority of flowers had the modal number. Here we clearly have a condition intermediate between the variable sepal number found in *Anemone nemorosa*<sup>15</sup> for example, and the selection where thousands of flowers must be examined before a deviation from the standard is found. My data are superficially comparable with those of Browne<sup>2</sup> who found that 77.1% of a thousand jellyfish *Aurelia aurita* had the modal number of 8 tentaculocysts. However he was studying a population, whilst I was studying individual plants.

There is clearly a strong but not overwhelming tendency to produce the normal number of six petals. It is reasonable to tabulate the percentage of "abnormal" flowers, i.e., those with a petal number other than six. This is closely related to the standard deviation, but is easier to calculate, and its sampling error does not involve the calculation of the fourth moment. The percentages of abnormality for the three plants were  $25.37 \pm 0.25$ ,  $26.48 \pm 0.24$ , and  $33.69 \pm 0.40$ . That is to say, regulation was far looser in the third.

The mean petal numbers altered significantly being lowest about the end of November. And the trend was marked. On the other hand, the percentages of abnormality increased with time which in the first five and the last sixteen days were as given in Table II. The number of flowers produced per day during the end of the season was much less than that in the earlier part of the season. And the reason for considering five days initially and sixteen days at the end was to reduce difference in the sample size of the two groups which were compared.

TABLE II

Percentages of abnormality in the first five and last sixteen days

Plant	1	2	3
First 5 days	$20.93 \pm 0.99$	$23.48 \pm 1.44$	$28.02 \pm 1.76$
Last 16 days	$30.75 \pm 2.16$	$37.24 \pm 2.44$	$37.61 \pm 2.30$

It will be seen that the regulation was greatly reduced in each case.

These data open up a nearly new field of research, since previous workers have seldom counted enough organs on the same plant to

establish differences in the variation between different plants, still less with time. This applies to the work of Pearson<sup>11</sup> and his colleagues on homotyposis. Perhaps the most comparable results are those of Price-Jones<sup>12</sup> on diameters of human red blood corpuscles. Here the coefficients of variation differed between normal individuals and were greatly increased in pernicious anæmia. Attfield<sup>1</sup> subsequently observed significant increase in variance of the diameters of red blood corpuscles of mice in anæmia.

There are, of course, a number of more or less comparable data on the variation between individual members of different clones of Protozoa<sup>10</sup> and of pure lines of mice<sup>6,9</sup> and the like.<sup>7,8,13,14</sup> The regularity with which members of a genotype develop has been described as the effect of developmental homœostasis. Here it can be studied on a very large scale.

The work is being extended to the study of other individual plants and other characters. For a character as well regulated as petal number very large samples are needed. Samples of 500 flowers or less would not reveal differences of the order found. Since most work of this kind has been done on herbs, no comparable observations are on record.

I wish to record my sincere thanks and indebtedness to Prof. J. B. S. Haldane, F.R.S., for initiating and suggesting this problem and for his kind help in the presentation of this note. My thanks are also due to Prof. P. C. Mahalanobis, F.R.S., Director, Indian Statistical Institute, for his keen interest and encouragement in this investigation.

Biometric Res. Unit, SUBODH KUMAR ROY.  
Indian Statistical Inst.,  
Calcutta-35, December 23, 1957.

1. Attfield, M., *J. Genet.*, 1951, **50**, 250-63.
2. Browne, E. T., *Biometrika*, 1901, **I**, 90-108.
3. Co-operative Investigations on Plants—*Ibid.*, 1901-02, **1**, 125-28.
4. —, *Ibid.*, 1902-03, **2**, 145-64.
5. —, *Ibid.*, 1905-06, **4**, 394-426.
6. Grüneberg, H., *Nature*, 1954, **173**, 674-76.
7. Lewis, D., *Ibid.*, 1953, **172**, 1136-37.
8. Mather, K., *Evolution*, 1950, **4**, 340-52.
9. McLaren, A. and Michie, D., *Nature*, 1954, **173**, 686-87.
10. Pearl, R., *Biometrika*, 1906-07, **5**, 53-72.
11. Pearson, Karl (and others), *Phil. Trans.* 1901, **197A**, 285-379.
12. Price, Jones, C., *J. Path. Bact.*, 1929, **32**, 479-501.
13. Rasmuson, M., *Acta. Zool.*, 1952, **33**, 277.
14. Robertson, F. W. and Reeve, E. K. R., *Nature*, 1952, **170**, 286.
15. Yule, G. U., *Biometrika*, 1901, **I**, 3, 307-09.

### PERIODICITY OF WUCHURERIAN MICROFILARIÆ IN HUMAN BLOOD

THE present investigation was undertaken to find out if microfilariae of Indian species of filarid worms may also show diurnal incidence. As at present the blood for detection of Indian Wuchererian parasites has to be collected at late hours of night which is rather an inconvenient time if large-scale survey in a rural area has to be conducted. It would solve much of the difficulty if the diurnal blood could provide us some index for determining the extent of filarial endemicity in the country.

With that object in mind, peripheral blood, about 20 c.mm., of certain subjects was collected in the field at different hours of the day and night for study, and the results are summarised in Table I.

TABLE I  
*Bancroftian microfilariae count at different hours*

No of persons	7 A.M.	7 P.M.	9 P.M.	Mid-night	2 A.M.	4 A.M.
1-6	4*					
7		6	..	24	19	23
8		..	3	..	4	11
9		..	nil	43	..	48
10		..	2	25	..	19
11		..	6	8	16	..
12		24	..	34	..	..

\* Out of six persons examined, only one showed the parasites at the hour shown. At other hours of the day, 9, 12 and 15, the blood was free.

Blood of six persons (7-12) only could be obtained at different hours involving the night: these patients were either from Bankura (Rajagram), Burdwan (Kotalhat) or Hooghly (Kotrung). The study shows that the microfilariae are most abundant towards midnight. There are two peaks, one at midnight and the other toward early hours of 4 A.M.

In only one patient from Burdwan out of six examined at different intervals during the day the blood proved positive for 7 A.M. sample. The parasites disappeared from the blood after this. Further study around Contai (Midnapore) where *malayi* type of parasites predominates indicated that the microfilariae are not likely to appear again before 5 P.M., when certain subjects proved positive, but the count was meagre.

The results show that the filarial parasites although not altogether absent in day blood, the rate did not exceed 3% of that observed in night blood from the same locality. Iyengar (1938) observed the same in *malayi* infection

in Travancore. Observations carried out by Chaudhury and Bhaduri (1955) proved the futility of utilising day blood in assessing filarial incidence of the bancroftian type as well, for they found that nearly 25 to 50 times more blood has to be collected if the parasites are to be detected in day blood, an improbable task in field work. The findings reported here, although in a small series, also lend support to the view that day blood in India should not be depended for working out the filarial incidence; the night blood should form the best means for it.

School of Tropical Medicine, P. SEN.  
Calcutta, January 21, 1958.

1. Iyengar, M. O. T., *Ind. Med. Res. Mem.*, 1938, 5, 78-82.
2. Chaudhury, A. B. and Bhaduri, N. V., *Bull. Cal. Sch. Tr. Med.*, 1955, 3, 53.

#### ON SAL WOOD EXCAVATED FROM MAURYAN PILLARED HALL, PATALIPUTRA

SAL (*Shorea robusta* Gærtn.) is one of the most important constructional timbers of North India. References to its glories and virtues are found even in ancient Indian literature.<sup>1,2</sup> But direct evidence about its use in ancient India is surprisingly scanty. We have had occasion to examine a large number of timbers belonging to pre-historic and proto-historic times, but so far we had not come across any sal except in one instance. This was a huge wooden palisade<sup>3</sup> discovered during the excavation of ancient Pataliputra near Patna, which has recently been identified by Chowdhury and Ghosh<sup>4</sup> as sal (*Shorea robusta* Gærtn.). Based on radio-carbon (C 14) measurements, Chatterjee and co-workers<sup>5</sup> have estimated its age as  $2115 \pm 250$  years. This appears to be the oldest record for use of sal.

Recently, we have come across some more material from ancient Pataliputra, evidently belonging to the Buddhist period of Mauryan age. It is reported to belong to wooden beams used as an important fixture of the so-called Mauryan Pillared Hall.<sup>6</sup> This wood also has now been identified as sal (*Shorea robusta* Gærtn.). Due to the great antiquity of the wood as well as lack of any direct evidence for sal wood having been put to use so many years ago, its characteristics are recorded here briefly.

Due to ageing, the general appearance of the material is not like sal. It is almost dirty grey in colour now, but when split, a shade of greyish-brown colour is noticeable in the inner portion of the wood. The wood is free from any

attack by insect or fungus. However, the exposed portions show the effect of weathering due to natural causes. From the gross features, it appears that the wood comes from a large-sized log, as the specimens examined indicate that they are neither from very near the pith nor from near the periphery. Further, the material does not give any idea of sapwood or transitional heartwood, popularly known as *kucha-pucca* heartwood.<sup>7</sup> The wood is dense, hard, and when cut with a sharp knife reveals the macroscopic structure remarkably well. It is dull, heavy (specific gravity 0.816), interlocked-grained and medium coarse-textured. The characteristic ribbon-grain effect of sal is not distinct due to loss of colour contrast in alternating layers of tissues.

The visibly intact anatomical structure as seen under the microscope agrees in all essential details with that of fresh sal wood. Sections, when stained with Haidenhein's hæmatoxylin and safranin O, however, are not very bright due to rather weak response to safranin. This indicated to some extent the visible effect on lignin, particularly of the thick-walled fibres. Further, the material could be cut with comparatively less difficulty than sal of today, suggesting possible changes in the chemical nature of the cell-walls of various tissues. The wood is typically diffuse-porous and is characterised by indistinct growth marks, moderately small to moderately large vessels, 56-252  $\mu$  in diameter and most heavily plugged with tyloses (Figs. 1, 2); vertical gum ducts often arranged in tangential bands and sometimes found choked with tylosoids or tyloses-like structure: parenchyma conspicuous round the vessels and gum ducts, sometimes extending sideways across the rays; diffuse parenchyma scanty; fibres retain their shape remarkably well, showing dense, compact, very thick-walled structure with very much reduced lumen (Fig. 1); rays filled with heavy deposits, usually 3-5 cells and up to 84  $\mu$  in width, and up to 54 cells or 1,008  $\mu$  in height, almost homogeneous (Fig. 2).

This relict is of great interest for more than one reason. It gives us some idea of the knowledge, people of the Mauryan age possessed regarding the properties and uses of timber. As one of the most durable timbers in contact with soil, the reputation of sal is well known to us today. This special property of sal must have been known to them also as judged by their efficient use of this timber even according to modern standards. Further, a reference to the photomicrographs will at once reveal a very uniform anatomical structure of sal of fairly high quality, having moderately few vessels,

dense tracts of thick-walled fibres, and proportionately less of parenchyma (Fig. 1). Moreover the wood represents a mature portion of the heartwood having vessels completely packed with tyloses impeding the entry and growth

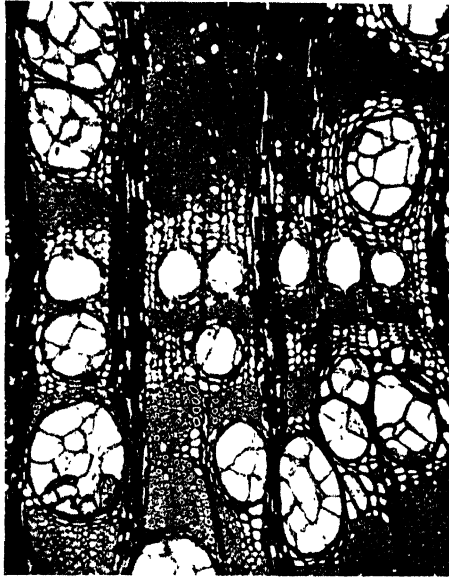

FIG. 1. Transverse section of the wood from Pataliputra. Note heavily tylosed vessels, dense fibrous tissue and a tangential row of gum ducts in the middle of the photo ( $\times 65$ ).



FIG. 2. Tangential section to show well preserved rays, parenchyma and vessel. Note thick and dark strands of fibres on the left and a vessel choked vertically with tyloses on the extreme right ( $\times 65$ ).

of insects and fungi in the wood (Figs. 1, 2). From this it will not be unreasonable to suppose that the people of this civilization knew what constituted the best sal from the point of view of strength and durability.

Observations on sal have shown that timbers of mature trees even after being used for 25 years still remain strong and durable. The specimens from Pataliputra, however, indicate a very high durability of heartwood of sal not so far recorded. The good state of preservation of the wooden palisade which remained in the ground for over 20 centuries at Pataliputra led Purushottam and co-workers<sup>8</sup> to conclude that these must have had a preservative treatment. At that time, the identity of the timber used was not at all known to them. Taking into consideration the fact that heartwood of sal is not amenable to any treatment, their conclusion regarding preservative treatment of the wooden palisade would appear to be rather speculative. Moreover, microscopic examination did not show any evidence of such a treatment. From our experience of the study of ancient woods, another point which may be of interest is recorded here. It has been noticed from various excavations made so far that just as teak (*Tectona grandis* Linn. f.) has been a predominant timber in important fixtures of Buddhist monasteries and caves and other temples in South-West India, sal has been characteristic in North India. This would mean that out of the large number of species available in the forests of India, the ancients must have had wealth of experience to select the most important timbers in South and North India.

Grateful acknowledgement is due to Shri V. K. Mishra, M.A., K. P. Jayaswal Research Institute, Patna, for sending the materials for study and supplying some field notes concerning the excavation.

Forest Res. Inst.,  
Dehra Dun,  
December 20, 1957.

S. S. GHOSH.  
KRISHNA LAL.

1. Shamasastri, R., *Kautilya's Arthashastra*, 2nd Ed., 1928.
2. Majumdar, G. P., *Some Aspects of Indian Civilization*, 1938.
3. Smith, V. A., *Asoka, the Buddhist Emperor of India*, 3rd Ed., 1920.
4. Chowdhury, K. A. and Ghosh, S. S., *Indian Woods*, 1 (in press).
5. Chatterjee, S. D. and Co-workers, *Sci. and Cult.*, 1938, 20, 615-17.
6. Ghosh, A., *Indian Archaeology, 1954-55—A Review*, 1954.
7. Chowdhury, K. A., *Ind. For. Bull.*, 115, 1942.
8. Purushottam, A. and Co-workers, *Ibid.*, 168, 1953.



**XYLEBORUS DISCOLOR BLAND., AS A  
PEST OF CACAO**

In recent years attempts are being made to increase the area under Cacao—*Theobroma cacao* L. in this country with a view to reduce the import of this popular beverage. Beeson (1919) has recorded a few wood-borers, viz., *Chrysochroa bicolor* F., *Dihamus rusticator* Germ., and *Xylothrips flavipes* Ill., as pests of this crop in India. Ramakrishna Ayyar (1919) has observed that *Planococcus* (*Pseudococcus*) *citri* Risso, is the most important pest in Madras. Recently the authors had occasion to notice a bad incidence of ambrosia beetles' (Scolytidæ) attack, leading to the gradual wilting of the affected trees in the Nilgiris.

Three species belonging to the genus—*Xyleborus*—are concerned in the damage. One has been determined as *Xyleborus discolor* Bland. by the Forest Entomologist, Dehra Dun. The other two appear to be new and will be described by him elsewhere. In general, the beetles are about 2 mm. in length, short and cylindrical, pronotum testaceous and elytra dark brown to testaceous. The grubs are creamy white in colour. They tunnel inside the stems and confine their activities mostly to young branches. As a result of the damage caused, the leaves begin to fade and ultimately the affected branch dries up.

*Xyleborus discolor* Bland. was first described by Blandford (1898) from specimens collected on Cacao in Ceylon and forwarded for determination by Green. This species is polyphagous and attacks a number of plant species, viz., *Hevea* (*rubber*), *Albizia*, *Lonicera caprifolium*, *Cassia multijuga*, *Tephrosia candida*, *Coffea arabica*, and several others.

The above observations were made under a scheme financed by the Indian Council of Agricultural Research.

I. P. JANAKI.  
T. S. MUTHUKRISHNAN.  
K. R. NAGARAJA RAO.

Entomological Division,  
Agricultural College and  
Res. Institute,  
Lawley Road P.O.,  
Coimbatore, January 4, 1958.

1. Ayyar, Ramakrishna, T. V., *J. Bombay Nat. Hist. Soc.*, 1919, 26 (2), 621-28.
2. Beeson, C. F. C., *Indian Forester*, 1919 (a), 45 (2-3), 49-56, 139-53.
3. —, *Ibid.*, 1919 (b), 45 (9), 488-95.
4. Blandford, F. H., *Trans. Ent. Soc.*, London, 1898, Pt. IV, 423.

**STEGANA LATERALIS V.D. WULP  
AS A PEST OF SESBANIA  
GRANDIFLORA**

*Sesbania grandiflora* or 'Agathi' is a leguminous crop grown largely as a standard for betel vine (*Piper betel*) in South India. During the course of observations made at Podanur (Coimbatore District) on the biology and control of the stem weevil *Alcidodes bubo*, F., a serious pest of this crop, the authors had occasion to notice certain maggots boring into the tender shoots of grown-up plants causing a gradual wilting of the affected ones. These were collected and kept under observation in the laboratory. The adults that emerged belonged to the family *Drosophilidæ* and were got identified as *Stegana lateralis* v.d. Wulp by the kind courtesy of the Director, British Museum, London. This fly was seldom seen to attack young seedlings.

The original description of this species has been made from specimens collected at Ceylon and so far as the authors are aware no information is available about its distribution. This is the first record of the occurrence of this fly as a crop pest in India. The adult is an active, dull yellowish fly measuring 3.5 mm. in length and the maggots are about 4.5 mm. in length when full grown and are pale white in colour. Pupation takes place inside the stem and the pupa is about 3.7 mm. long and reddish brown in colour. The adults emerge in 4 to 5 days from the pupæ. The damage done by this fly to the crop was noted to be very appreciable and, if neglected, this may 'become a major pest of this crop in betel vine gardens. Further studies are in progress.

Division of Entomology, T. R. SUBRAMANIAN,  
Agric. College and K. R. NAGARAJA RAO,  
Res. Institute,  
Coimbatore, December 21, 1957.

**ON THE ANTHERIDIUM IN  
CHARACEÆ**

The antheridium in the different Characeæ is generally believed to have a uniform structure and development (see Fritsch, 1935; Smith, 1955). The writers have studied the antheridia in two species of *Chara*, *C. corallina* Willd., and *C. zeylanica* Willd.

The antheridium in *C. corallina* is very similar in structure to those already described in the other Characeæ. The mature antheridium has eight shield cells (octoscutate) and each shield (a) carries a manubrium (b), and a primary capitulum cell (c). The cell that is

to form the antheridium first divides transversely cutting off a lower cell, the pedicel cell (*p*), and then the upper cell by two vertical divisions (planes 1'-1', 2'-2') form four quadrately arranged cells; each of these four cells divides transversely (plane 3'-3') resulting in an eight-celled structure. Each of these octads undergoes 2 periclinal divisions ultimately leading to a globular structure of 24 cells arranged in three concentric layers (Text-Figs. 6, 8).

The outermost become the eight shield cells, the innermost become the primary capitulum cells and the middle eight ultimately form the eight manubria. The pedicel cell elongates and protrudes into the interior of the antheridium (Text-Fig. 7). Thus a fully mature antheridium, in a transverse section, shows 4 shield cells, 4 manubria and 4 primary capitulum cells and 4 similar sets together with the pedicel cell in the vertical section.

In a collection of *Chara zeylanica* from S. Africa, Groves (1931) has reported the presence of four shield cells only (quadriscutate). This paper, however, has been overlooked or not taken notice of by most writers (see however, Zaneveld, 1940, p. 206). Tuttle (1924) has earlier pointed out a similar condition in an unidentified species of *Nitella*. Sundaralingam (1954) has worked out the developmental morphology of *C. zeylanica*. But he apparently overlooked this point. Those preparations as well as abundant fresh material have been restudied. The present study has shown that Groves' observations hold good with regard to the South Indian plants too. Up to the formation of the four quadrately-arranged cells, the development of the antheridium is the same as in *C. corallina*. That is, divisions in planes 1'-1' and 2'-2' take place but the transverse division in plane 3'-3' does not take place (Text-Fig. 2). Thus the octad stage is not formed. These four quadrately arranged cells undergo two periclinal divisions and as a result, the ultimate structure is made up of 12 cells only, arranged in three concentric layers (Text-Figs. 3, 4); the outermost four develop into the four shield cells (*a*), the innermost into 4 primary capitulum cells (*c*) and the middle into the 4 manubria (*b*). Thus in the mature condition, a transverse section of the antheridium reveals three concentric layers (Text-Fig. 4); and in a vertical division of the antheridium, one finds only two shield cells, 2 manubria and 2 primary capitulum cells, together with the pedicel cell (Text-Fig. 1). Thus *C. zeylanica* has a quadriscutate antheridium.

The shields also look different in surface view. In the case of the octoscutate antheridia, the shield cells are nearly triangular (Text-Fig. 9), whereas in the quadriscutate condition, they are roughly rhomboidal or lozenge-shaped (Text-Fig. 5). It will be interesting to study as many Characeae as possible to find out the condition of the antheridium and the mode of its development.

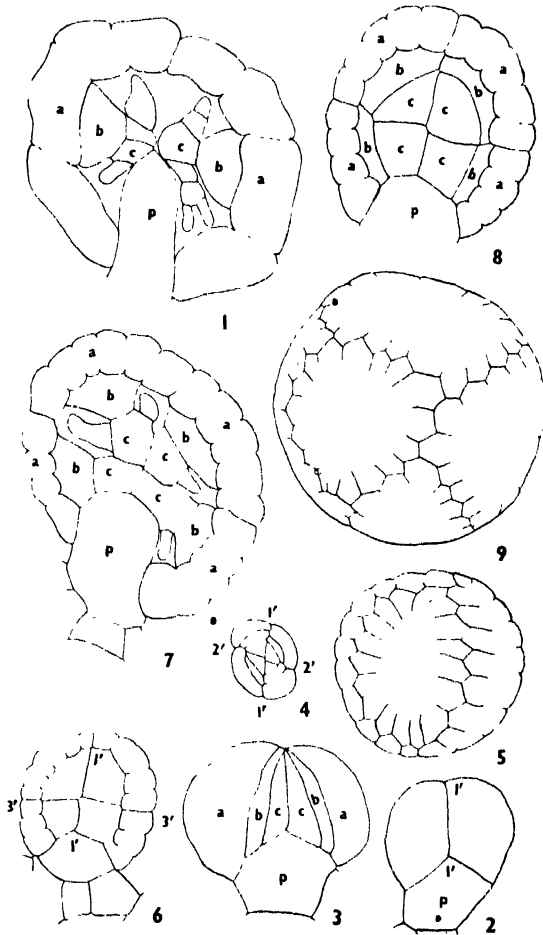

TEXT-FIGS. 1-5. *Chara zeylanica*. Figs. 1-3. Vertical sections of the antheridia; Fig. 4. Cross-section of the entire antheridium at stage shown in Fig. 3. Fig. 5. External view of the entire antheridium.

TEXT-FIGS. 6-9. *Chara corallina*. Figs. 6-8. Vertical sections of the antheridia. Fig. 9. External view of the entire antheridium. (1'-1', 2'-2', 3'-3'-planes of division; *a* = shield cell; *b* = manubrial cell; *c* = primary capitulum cell; *p* = pedicel cell.)

Magnifications: FIGS. 1, 5, 7,  $\times 290$ .

FIGS. 2, 3, 8,  $\times 320$ .

FIGS. 4, 6, 9,  $\times 150$ .

The writers are grateful to Dr. T. V. Desikachary for his kind help and suggestions.

University Botany Lab., V. S. SUNDARALINGAM.

Madras; and K. J. FRANCIS.

Botany Dept.,

University of Saugar,

Sagar, January 24, 1958.

1. Fritsch, F. E., *The Structure and Reproduction of Algae*, Cambridge, 1935, 1, 791 pp.
2. Groves, J., 'On the antheridium of *Chara zeylanica* Willd.," *J. Bot.*, 1931, 69, 97-98.
3. Smith, G. M., *Cryptogamic Botany*, McGraw-Hill, New York, 1955, 1, 546 pp.
4. Sundaralingam, V. S., "The developmental morphology of *Chara zeylanica* Willd.," *J. Ind. bot. Soc.*, 1954, 33, 272-97.
5. Tuttle, A. H., "The Reproductive cycle of the Characeae," *Science*, n.s., 1924, 60, 412-13.
6. Zaneveld J. S., "The Charophyta of Malaysia and adjacent countries," *Blumea*, 1940, 4 (1), 1-223.

#### CHROMOSOME NUMBERS OF SOME DICOTYLEDONS

SOME new chromosome numbers were determined by me in the course of systematic studies on the angiosperms. The determinations (Table I) were based on meiotic divisions in anthers prefixed in acetic alcohol and squashed in aceto-carmine.

TABLE I

Species	Family	Haploid Chromosome No.
<i>Clerodendrum infortunatum</i> Linn.	Verbenaceae	26
<i>Albizzia lebbek</i> Benth.	Mimosaceae	13
<i>Indigofera pulchella</i> Roxb.	Papilionaceae	8
<i>Dalbergia sissoo</i> Roxb.	do.	10
<i>Rhizophora mucronata</i> Lamk.	Rhizophoraceae	18
<i>Croton bonplandianum</i> Baill. ( <i>Croton sparsiflorus</i> Morong) <sup>3</sup>	Euphorbiaceae	10 (vide Fig. 1)
<i>Alstonia macrophylla</i> Wall.	Apocynaceae	11

In the list given above (Table I) all except two species are indigenous or naturalised. The two exceptions are *Croton bonplandianum* Baill. and *Alstonia macrophylla* Wall. *Croton bonplandianum* is a native of South America, introduced into Bengal about the year 1898.<sup>1</sup> Material for the present observations on this species was collected at Lucknow where it is abundant in waste places. The plant is not mentioned by Duthie<sup>4</sup> and is a recent introduction to U.P. and the Upper Gangetic Plain.<sup>5</sup>

*Alstonia macrophylla* is a native of Malaya but has been planted in various parts of India.<sup>1</sup> Material for study was obtained from the National Botanical Gardens, Lucknow.

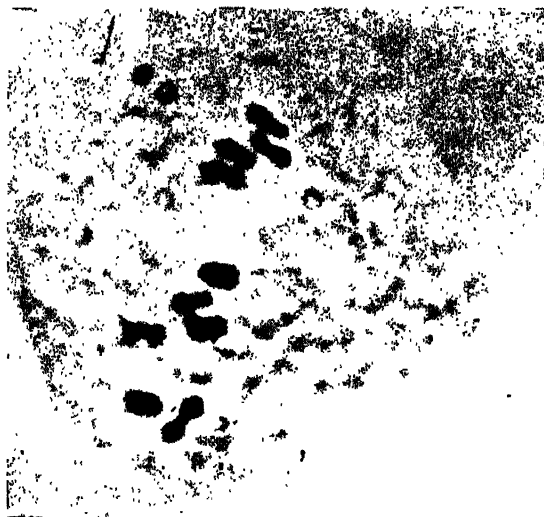

FIG. 1. *Croton bonplandianum* Baill. 10 bivalents at metaphase I in pollen mother cell,  $\times 1,500$ .

The remaining species in Table I, apart from their other uses, are medicinal.<sup>2</sup> Material for *Dalbergia sissoo* Roxb., *Clerodendrum infortunatum* Linn., and *Albizzia lebbek* Benth. was collected in and around Lucknow. Flowerbuds of *Indigofera pulchella* Roxb. were obtained from the botanical garden of the Forest Research Institute, Dehra Dun. Fixations for *Rhizophora mucronata* Lamk. were made at Bassein Creek, near Bombay.

I am grateful to our Director, Dr. E. K. Janaki Ammal, for facilities for the present study.

Central Botanical Lab., R. P. PATIL.  
Botanical Survey of India,  
Allahabad, December 26, 1957.

1. Benthall, A. P., *The Trees of Calcutta and Its Neighbourhood*, Calcutta, 1946, 312.
2. Chopra, R. N., Nayar, S. I. and Chopra, I. C., *Glossary of Indian Medicinal Plants*, New Delhi, 1956.
3. Croizat, I., *J. Bombay Nat. Hist. Soc.*, 1940, 41, 573.
4. Duthie, J. F., *Flora of the Upper Gangetic Plain*, Calcutta, 1915, 3, Part 1.
5. Joshi, A. C., *Curr. Sci.*, 1934, 2, 344.
6. Mayuranathan, P. V., *The Flowering Plants of Madras City and Its Immediate Neighbourhood*, Madras, 1929, 267.

**LATERAL BUD DEVELOPMENT IN  
'PEARL MILLET'—*Pennisetum*  
*typhoides* STAPF ET HUBBARD,  
IN RELATION TO ITS FLOWERING**

BRANCHING and other abnormalities in the reproductive spike in cereals and other plants are on record from early days. The earlier work has been reviewed elsewhere.<sup>1</sup> A comprehensive review of the more recent observations on the subject has also appeared lately.<sup>2</sup> Abnormalities in the reproductive spike in *Pennisetum typhoides* have also been reported by some workers.<sup>3,4</sup>

During the course of extensive investigations on growth and development of a number of millets carried out in this laboratory, some interesting observations were recorded on the development of lateral buds and their flowering. As the results are interesting and throw light on the relationship between growth and development, these are briefly reported in the present communication.

The seeds of *Pennisetum typhoides* strain Cumbu Co. 1, along with seven other types of millets were obtained through the kind courtesy of Mr. P. Krishna Rao, Millet Specialist, Agricultural Research Institute, Coimbatore, in 1949. The seed was sown both in the field and pots in June 1952, and records were kept of the dates of emergence of the individual branches and the ears on them. From these records calculations were made for the vegetative periods of the main shoot as well as the branches. The mean period between the day of sowing and the day of ear-emergence of the main shoots of 5 plants was taken as the vegetative period of the main shoots, while on the other hand, the period between the day of branch emergence and the day of emergence of its spike was taken as the vegetative period of that branch.

The vegetative period of the main shoot as well as the number of branches along with their vegetative periods in the pot experiment are diagrammatically represented in Fig. 1. In this figure the vertical line in the middle marked with 'M' represents the main shoot, while those on the sides represent the branches. The branches emerging from the axils of the leaves on the main shoot are referred as 'primary branches'. These are drawn with thick double vertical lines and are marked with numerals to denote the order of their emergence on the main shoot. The branches that arise in the axil of the leaves of the primary branches are referred as 'secondary branches' and are drawn with thin double vertical lines. These have

been marked with a letter to indicate the order of their emergence. Thus there are two branches that arise from the primary branch 4. The first of these two that emerges from the

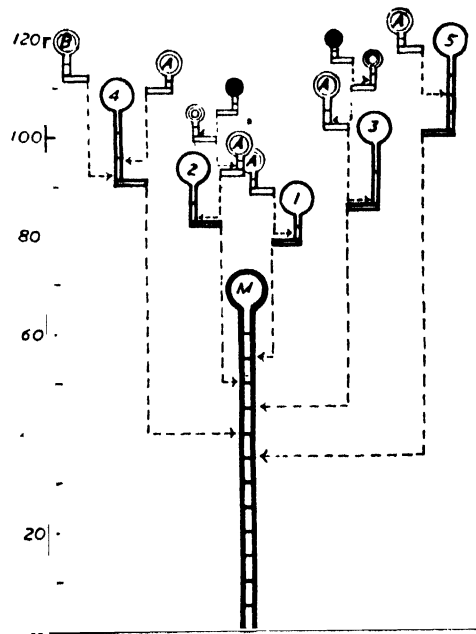

FIG. 1. Diagrammatic representation of plants showing number of branches as well as lengths of the vegetative periods of the main shoot and the branches in *Pennisetum typhoides*.

upper node is marked 'A' while the second one emerging from a node lower to it is marked 'B'. The period of branch emergence, i.e., the period (in days) elapsing between the date of sowing and the emergence of a branch is indicated by the horizontal double line which is placed at such a distance from the abscissa that it gives the time of branch emergence from the date of sowing. The position on the main shoot (or the primary or secondary or tertiary branch) from which this branch emerges is indicated by an arrow that terminates below a dotted line which connects it with the main shoot in the case of primary branches and a primary, secondary or tertiary branch in the case of secondary, tertiary or further branches respectively. This position is in relation to the inflorescence (of the main shoot or the branch as the case may be) which is represented in each case by a circle that terminates the upper end of the vertical line. While the inflorescences of the main shoot and primary branches are represented by circles with single lines, those of secondary branches are represented by circles with double

lines. The inflorescences of tertiary branches are shown by circles with triple lines and the blackened circles represent the inflorescences of the branches that emerge from the tertiary branches. The length of each vertical line represents the vegetative period (in days) of that particular branch. Thus the distance of the circle of the main shoot from the abscissa represents the vegetative period of the main shoot while the distance between the circle and the horizontal line of a particular branch represents its vegetative period. The marks on the vertical lines represent the nodes on the main shoot or the branches.

It is seen from this figure that the emergence of the ear of the main shoot takes place in about 65 days. The emergence of lateral branches occurs only after that and takes place in a regular basipetal succession. Thus, the first primary branch appears in the node next to the apical spike 78 days after sowing. The second branch emerges from the next node below it after 82 days. The third, fourth and fifth branches arise after 85, 90 and 99 days respectively from fourth, fifth and sixth nodes counting from above. The flowering of these branches also takes place in the same basipetal succession, i.e., the branch nearest to the apical spike showed ear-emergence first followed by the second below it and so on. The length of the vegetative period varies in these branches as is indicated by the length of the vertical lines representing them. Thus the vegetative period is only 6 days in the case of first branch and increases to 16 days in the fifth branch. As a result of this the length of the branches increases from top downwards. The first branch is, thus, very short and the lower ones are longer than this. The number of nodes in the upper 3 branches is only 2 while in the fourth branch it is 3 and increases to 4 in the fifth branch. While the emergence of secondary branches on the lower primary branches with more than two nodes takes place in basipetal manner, as is the case with primary branches on the main shoot, each one of the upper primary branches (having two nodes each) shows one secondary branch which arises in the axil of the leaf next to the boot leaf. The emergence of this branch takes place after the emergence of the ear of the primary branch on which these are borne. Like the upper primary branches these secondary branches also consist of only two nodes so that there is only one tertiary branch that emerges from the lower of these two nodes in each case. In many cases further branching of these tertiary

branches takes place and since all these branches arise from the lower of the two nodes in each case, as many as 4-6 branches appear to arise from the same node sometimes (Fig. 2). It



FIG. 2. The emergence of primary, secondary, tertiary and further branches in *Pennisetum typhoides*. A number of branches appear to arise from the same node in some cases.

is, however, interesting to note that the emergence of a branch takes place only after the emergence of the ear of the primary, secondary or tertiary branch on which that particular branch is borne. These results, thus, clearly show that the pattern of branching in the case of *Pennisetum typhoides* is somehow related with the developmental process of this plant. Similar effects of the developmental process on the pattern of branching in the case of *Panicum miliaceum* have been reported elsewhere.<sup>5,6</sup>

The other peculiarities about the axillary spike development were that in many cases there was complete sterility and also the form of the spike varied considerably, even on the same plant. The sterility of these spikes is of special significance. The pollen fertility has been found to be considerably influenced by differential photoinductive treatments.<sup>7,8</sup> It appears, therefore, that the sterility was most probably due to unfavourable photoperiod in which this variety of *bajra* was growing at Delhi. This suggests that its gametogenetic phase was adversely affected. The very fact that spikes have been formed on almost all the nodes signifies that this is not a case of re-

versal in phasic development but a disarrangement in some of the developmental phases. Further discussion on this subject is reserved for a later date when the full data will be presented.

Dept. of Botany, K. K. NANDA.  
University of Delhi, J. J. CHINOV.  
Delhi-8, December 20, 1957.

1. Bose, R. D., *Ind. J. Agric. Sci.*, 1935, **5**, 155-64.
2. Chinov, J. J. and Nanda, K. K., *Ibid.*, 1946, **16**, 390-99.
3. Rangaswamy Ayyangar, G. N., *et al.*, *Curr. Sci.*, 1935, **4**, 237-38.
4. Chandrasekharan, S. N. and Daniel Sundararaja, D., *Ibid.*, 1950, **19**, 92-93.
5. Nanda, K. K., Grover, R. and Chinov, J. J., *Pyton.*, 1957, **8**(2), 97-108.
6. Nanda, K. K., *Ibid.*, 1957, (in press).
7. — and Chinov, J. J., *Curr. Sci.*, 1945, **14**, 241.
8. —, *Plant Physiol.*, 1957, **32**, 163-69.

#### THE STUDY OF SEED CONTENT AND FRUIT SHAPE IN RELATION TO REMOVAL OF STIGMA IN *LUFFA* SPECIES

THE gynœcium in *Luffa* species is tricarpeillary, syncarpous and trifold. The three stigmas and carpels are radially arranged. On maturity, the fruits have three chambers containing seeds, separated from one another by thick fibrous network and thus not allowing any intermixing of the seeds. During the course of an investigation on the floral biology of *L. acutangula*, Roxb. and *L. cylindrica* (Lour.) Roem., the pollen distribution among the three stigmas was studied in relation to radial symmetry. The experiment consisted in bagging of the pistillate flowers a day before anthesis, and

pollinating them in the following three ways, almost on similar lines, as followed by Mann (1943) in water melons :

- (i) Pollen applied to all the three stigmas.
- (ii) One stigma removed and the rest two pollinated.
- (iii) Two stigmas removed and pollen applied to the third one.

Care was taken to avoid the application of pollen grains on the cut surfaces in treatments two and three. In the first and second set of treatments, nearly all the treated female flowers set fruits but in the third case there was about 15% mortality. The seeds contained in each of the three chambers of a fruit corresponding to each treated stigma were counted separately and their number is given in Table I.

It is clear from Table I that the seed chamber corresponding to the removed stigma, contained few seeds, while those corresponding to the unremoved ones, to which the pollen was evenly applied, contained a large number of seeds. In case of fruits where two stigmas were removed, the corresponding seed chambers contained considerably lesser number of seeds. The development of few normal seeds in the chambers corresponding to the stigmas, which had been removed, was due to the fertilization of the ovules by pollen tubes diverted from the styler canal of intact stigma. This becomes more evident in view of nearly equal distribution of seeds in all the three chambers of the fruits formed as a result of the first treatment (Table I). This may be due to equal number of pollen tubes travelling down the styler canal and fertilizing an equal number of ovules.

TABLE I  
*The effect of stigma removal on seed distribution in fruit chambers of Luffa species*

		Average seed content per fruit in								
Material	Type	Control			One stigma removed			Two stigmas removed		
		1st chamber	2nd chamber	3rd chamber	1st chamber	2nd chamber	3rd chamber, stigma cut	1st chamber	2nd chamber, stigma cut	3rd chamber, stigma cut
<i>L. acutangula</i> ..	T 5	50.4	38.4	32.6	14.2	11.6	5.6	42.4	13.0	9.8
	T 9	75.3	70.6	68.3	57.3	52.0	16.3	64.6	16.6	10.6
<i>L. cylindrica</i> ..	T 20	258.6	246.8	227.8	195.4	178.8	54.2	222.6	56.6	39.6
	T 29	132.6	125.0	114.3	129.6	106.3	48.3	141.0	59.0	33.0
	T 31	88.0	79.3	75.0	86.0	83.3	19.0	76.6	19.0	13.3

Large differences in seed chambers observed in the above table are associated with differences in the fruit size. The fruit shape, however, appears to be influenced more by relative number of seeds per chamber than by total number of seeds. A marked variation in shape was noticed in the long-fruited strains of T 5, T 9 and T 31. The side on which the stigma was intact showed a normal surface but the treated side showed a depressed or curved surface. The depression happened to be more in the treatments in which two stigmas were removed (Fig. 1).



FIG. 1. A, Normal; B, One stigma cut; C, Two stigmas cut.

It is, thus, clear that the removal of one or two of the three stigmas prior to pollination, and the consequential inequality of pollen distribution on the respective stigmatic surfaces, results in the distortion of normal fruit shape in the above two species of *Luffa*.

Govt. Horticultural Res. S. N. SINGH.  
Inst., Saharanpur,  
U.P., December 24, 1957.

1. Mann, I. K., "Fruit shape of water melons as affected by placement of pollen on stigma," *Bot. Gaz.*, 1943, 105, 257-62.

### PRIMITIVE FEATURES IN THE ALIMENTARY CANAL OF *GADUSIA CHAPRA* (HAMILTON)

MORPHO-HISTOLOGICAL studies of the digestive tube of fishes have been worked out in most of the groups of Teleostei. It is rather strange that Clupeidæ, being the most primitive family, has received very scanty attention from the Ichthyologists. But for the stray works of Stirling (1884)<sup>1</sup> on herring and on gizzard shad, *Dorosoma cepedianum* by Wier and

Churchill (1945),<sup>2</sup> no detailed literature exists. With this view the present work has been taken up which has shown some interesting and primitive features.

Depending upon the presence and absence of the taste buds, the fishes are supposed to belong to a group which apply their sense of taste in selecting their food or to another group which are blind-feeders. In case of *Gadusia chapra* (Hamilton), the taste buds are entirely wanting and one would naturally assume it to be a blind-feeder. But the study of the food contents in the stomach indicates that it is strictly a plankton-feeder and accordingly, as has been shown by Al-Hussaini (1947),<sup>3</sup> the gill rakers are very closely set on the branchial arches. The rakers are very well adapted for straining microscopic plankton from the water in a sieve-like fashion. This shows that the fish does apply some sense in selecting its food.

Over the dorsal surface of the snout, there is a rich concentration of nerve cells. Such concentrations are also present on the epithelium of the lip, tongue, pharynx and the œsophagus. The intensity of the concentration is highest on the lip (Fig. A). The histological

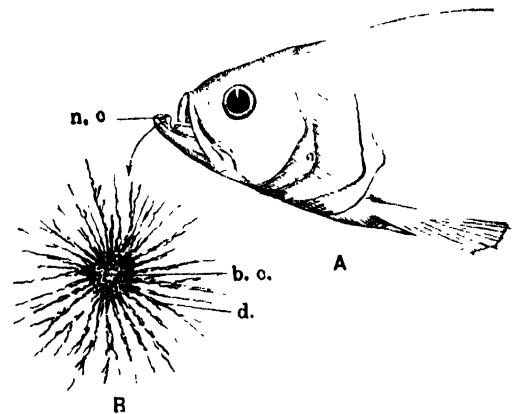

FIG. A. Lateral view of the head of *Gadusia chapra* to show the distribution of the nerve cells over the snout, lip and the tongue.

FIG. B. One of the nerve cells under microscope (low power).

[b.c. = cell body; d. = dendrites; n.c. = neuroglia cells.]

study shows that these nerve cells are present just below the mucosal epithelium, starting from the lip to the œsophagus. These cells are neuroglia cells which together with their processes, the dendrites, constitute the ground-substance in which the nervous elements lie embedded (Fig. B).

A very simple method had been adopted to demonstrate these nerve cells. A portion of the epithelium had been taken out from the anterior part of the buccal cavity (lower jaw) and the tongue with its supporting cartilage. They were treated with 10% KOH for about 15 minutes. Then they were washed thoroughly in water, dehydrated, cleared and mounted without staining.

Clupeidæ is the most primitive family of Teleostei and these nerve concentrations show a very interesting and primitive stage in the origin of the taste buds. In *Gadusia chapra* (Hamilton), the nerve concentrations are there on the lips, tongue, pharynx and œsophagus but the taste buds have not yet originated and become specialised in the mucosal epithelium. These nerve cells are responsible for carrying the gustatory sense to the brain and hence the fish is not a blind-feeder. Fishes are known where the taste buds occur from the buccal cavity to the œsophageal region. Further work is in progress and the detailed account will be published elsewhere.

Zoology Dept.,  
University of Allahabad,  
January 15, 1958.

P. N. SRIVASTAVA.

1. Stirling, W., *Rep. Scot. Fish.*, 1884, 2, 31.
2. Wier, H. C. and Churchill, E. P., *Proc. S. Dakota Acad. Sci.*, 1945, 25, 334.
3. Al-Hussaini, A. H., *Jour. Morph.*, 1947, 80, 251.

### ROOTS ON AN INTERNODE IN SUGARCANE

WHILE the occurrence of secondary meristem in internodal region resulting in the development of callus of various shapes and sizes was noted in sugarcane by some workers,<sup>1,2</sup> others<sup>3,4</sup> were able to produce such tissues artificially in several cases. Formation of roots on a portion other than the rootzone in sugarcane is extremely rare although in coconut they were mentioned to have appeared on old stems.<sup>5</sup> The abnormality reported in this note was found in a stalk of Co. 302 at the Sugarcane Sub-Station, Karnal, in December 1949, and is preserved at the Sugarcane Breeding Institute, Coimbatore.

In this interesting case, 24 roots, inclusive of rudimentary ones, were seen developing from the callus on one of the internodes (Figs. 1a, b). Coming out as they did from a small area, they were overcrowded and irregularly formed as against those usually formed in root zones from 50-75 root eyes which are arranged in

regular rows. While some of these internodal roots attained a length of 5 cm. there was no

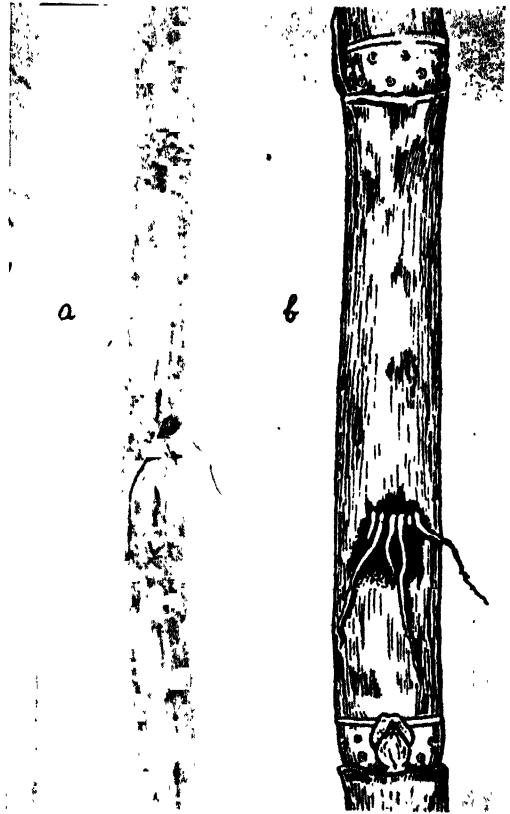

FIG. 1

Roots from the internode of Co. 302 (Photograph and pen and ink sketch of the same specimen).

formation of roots at either nodes immediately below or above the callus.

Central Coconut

T. A. DAVIS.\*

Res. Station,  
Kayangulam (Kerala),  
September 27, 1957.

\* Previously working at the Sugarcane Substation, Karnal.

1. Barber, C. A., *Memoirs Dept. Agric. (Madras), Bot. Series*, 1919, 9 (2), 56.
2. Martin, J. F., *Proc. Internat. Soc., Sugarcane Technologists' 4th Cong.*, 1932.
3. —, *Ibid.*, 6th Cong., 1938, 461-67.
4. Munzik, T. J. and LaRue, C. D., *Science*, 1952, 116, 589-91.
5. Menon, K. P. V., Davis, T. A., Anandan, A. P. and Pillai, N. G., *Indian Coconut J.*, 1955, 8, 79-91.



### CYTOLOGY OF *DIPLAZIOPSIS* *JAVANICA*

*Diplaziopsis* C. Chr. (= *Allantodia* Wallich) is a problematic genus amongst leptosporangiate ferns. It has undergone many systematic changes. Bower<sup>1</sup> treats it provisionally along with his 'Asplenoid Ferns'. Christensen<sup>2</sup> revised his opinion to give it a generic status and treats as 'a group of ferns with areolate veins' under *Diplazium*. Ching<sup>3</sup> and Dickason<sup>4</sup> place the genus in tribe Athyriæ of Family Aspleniaceæ. Copeland<sup>5</sup> includes *Diplaziopsis* in his Family Aspidiaceæ and accords it a position near *Athyrium* just at the end of the family. Holttum<sup>6</sup> in presenting a new classification of ferns does not refer to this genus.



FIG. 1 Spore mother-cell of *Diplaziopsis javanica* showing  $n = 41$ ,  $\times 970$ .

FIG. 2. Explanatory diagram to Fig. 1, from a bleached photograph,  $\times 970$ .

*Diplaziopsis* is essentially an old world genus with only two living representatives, namely, *D. javanica* (Bl.) C. Chr. and *D. cava-*

*leriana* (Christ) C. Chr.<sup>3,5</sup> The former is a type species of the genus and the latter is a native of China only.<sup>3</sup> While the detailed studies on anatomy, development of sorus and gametophytes are in hand, the present report aims to record the chromosome number of *Diplaziopsis javanica*. The basic number for the genus is unrecorded so far.

The species is reported from Eastern Himalayas, South India and Burma. Material for the present study was collected from Darjeeling area from different localities during the months of July and August. Usual aceto-carbamine squashes were prepared after fixing in Carnoy's Fluid for 24-48 hours. During meiosis 41 bivalents were unmistakably counted in several spore mother-cells of specimens from different localities (Figs. 1-2). The divisions are regular resulting in 64 well-filled viable bilateral spores with distinct perisporium.

It is noteworthy that to whatever family *Diplaziopsis* has been assigned, it has always been grouped with *Athyrium* and *Diplazium*. Furthermore, *Diplazium* has been united with *Athyrium* by both Copeland<sup>5</sup> and Holttum,<sup>6</sup> but it is retained as a separate genus by Manton and Sledge<sup>7</sup> on the ground that it differs consistently from *Athyrium* in having 41 as the base number whereas the base number in the latter genus is 40. The presence of  $n = 41$  in *Diplazium* (cf. Manton and Sledge<sup>7</sup>) and *Diplaziopsis* (this report) proves the close relationship of these two genera already established on morphological grounds and their distinctness from *Athyrium*.

I am indebted to Professor P. N. Mehra for his helpful criticism and encouragement, and to Mr. R. S. Pathania for the microphotograph.

Dept. of Botany,  
Panjab University,

S. S. BIR.

Amritsar, December 12, 1957.

1. Bower, F. O., *The Ferns*, Camb. Univ. Press, 1928, 3.
2. Christensen, C., *Filicinae* in Verdoorn's *Manual of Pteridology*, 1938, Hague.
3. Ching, R. C., *Sunyutsenia*, 1940, 5, 201-70.
4. Dickason, F. G., *Ohio Jour. Sci.*, 1946, 46, 73-141.
5. Copland, E. B., *Genera Filicum*, Waltham, Mass., U.S.A., 1947.
6. Holttum, R. E., *Biological Review*, 1949, 24, 267-96.
7. Manton, I. and Sledge, W. A., *Phil. Trans. Roy. Soc.*, London, 1954, 238 B, 127-85.

## REVIEWS

**Advances in Nuclear Engineering**, Vol. II. Coordinating Editors: John R. Dunning and Bruce R. Prentice. (Pergamon Press, Ltd., London W. 1), 1957. Pp. vii + 581. Price £ 7-7-0.

Volume II is the outcome of the Second Nuclear Engineering and Science Congress as Volume I. It comprises of 74 papers which in the main deal with Reactor Design, Metallurgical Instrumentation and other engineering problems in the field of reactor technology. The papers are presented under nine sections.

Section I deals under the title 'Reactor Design' the aspect of power generation with closed cycle gas turbines, the details of the Engineering Test Reactor at the National Reactor Testing Station in Idaho and Stress-corrosion cracking problems.

In Section II under reactor core design, two papers discuss the control systems employed in reactors. The control of a reactor is based upon introducing a material with good engineering properties having a high neutron capture cross-section. Relatively few elements are available for the purpose and these are Boron, Cadmium, Hafnium, Gadolinium, Samarium and Europium. The properties of these materials are discussed.

In Section III the operational problems met with in a homogeneous test reactor and a pressurised water reactor plant are discussed.

In Section IV under the title Educational Use of Reactors are described some low power reactors which can be installed in laboratories for instructional purposes. Two of the reactors dealt with are the small 5-watt laboratory reactor and a portable polyethylene-moderated training and research reactor.

In Section V which bears the title Metallurgy, 18 papers are presented under three subheadings: (1) Uranium Metallurgy and Radiation Effects, (2) Metallurgy of Reactor Materials, (3) Metallurgy of Uranium-Zirconium and Uranium-Niobium Alloys.

Zirconium base alloys, uranium and uranium alloys form the major portion of this Section. Corrosion resistance properties, transformation properties, effect of radiation on the physical properties of these materials are elaborately discussed in the papers. These are richly illustrated with microstructure photographs. A couple of papers deal with the aspects of mechanical properties of these alloys.

Section VI under the heading Natural Resources contains 8 papers on the mineralogical, geochemical and geological aspects of uranium bearing deposits and zirconium sources.

Section VII entitled Instrumentation is divided into three parts, namely, Reactor plant instrumentation, Reactor control and simulators and Reactor instrumentation development. Sixteen papers in all fall under these three headings.

In the general field of reactor instrumentation, four functions are to be fulfilled, viz., health safety, monitoring, control and the protection of nuclear reactors. Until the last three functions are fulfilled, the reactor cannot be safely used as either a neutron source or as a critical assembly. The first-named one is even more important from the health safety point of view of the operators. After these objectives are fulfilled, the programme is shifted to an experimental function. The papers presented deal with these aspects and the instrumentation part of some working reactors are discussed. The development of suitable electronic and electrical devices are also dealt with.

Section VIII deals with one of the most important engineering aspects of reactor technology, namely, Heat Transfer. The papers in this Section fall under three subdivisions again, viz., Primary Coolant Systems, Heat Transfer and Heat Evolution, and Problems Related to Heat Transfer.

In the last Section IX, preliminary consideration of standardization in the nuclear field and the need for it is discussed.

Volume II, as Volume I, is very well got-up and presents a wealth of information to engineers and metallurgists working in the field of reactor technology.

A. J.

**Progress in Nuclear Physics**, Vol. V. Edited by O. R. Frisch. (Pergamon Press), 1956. Pp. vii + 325. Price £ 4.00.

Volume V of *Progress in Nuclear Physics* contains a very readable collection of review articles dealing with fields of activity in nuclear physics which are all of topical interest. This volume maintains the high level set in the earlier issues. The articles are well written and have excellent bibliographies. The printing (both of text and diagrams), conforms to the usual excellent standards of Pergamon Press.

The one adverse criticism which must be levelled against this and some other members of the growing family of review journals is that the prices are so high that only libraries and perhaps a handful of research workers can afford to buy them. That these review journals are doing an excellent job and that they fulfil a real need and should therefore be available to the larger body of scientists is implicit in the above criticism.

The emphasis in this volume is slightly towards experiment. There are four articles which deal entirely with experimental methods and techniques. One, a comprehensive review, deals with organic scintillators. Another discusses new trends in electronic circuits used in nuclear physics research; the use of decimal counting tubes (dekatrons, trochotrons and ribbon beam tubes) which make it possible to build scaling units without complex scaling circuits and electromechanical devices, are dealt with in this, as also transistorization of circuits. The article on the bubble chamber certainly gives one a feeling for this new tool, which probably has had as much of an impact on the development of particle physics as the nuclear research emulsion. The importance of a technique of this description as visualized by its inventor, Glaser, and the principles underlying its operation are well brought out. It is unlikely that any revolutionary developments will now take place in this technique; the trend is to build "bigger and better" chambers. For a long time to come therefore, this article will be of use to non-specialists as an introduction to this field. The other experimental article is on the accurate determination of nuclear reaction energies.

There are three theoretical surveys. The article on the neutrino is of particular interest. It is well written and gives the experimental evidence for the neutrino and the theoretical position as existed in early 1956. The discovery of free neutrinos apparently rounded off the subject. No indication was available then of the tremendous change that was to come over the whole field of  $\beta$ -ray phenomena (and concerning the neutrino in particular) as a result of the discovery of non-conservation of parity in weak interactions. The word parity is used in this survey only with reference to the Gamow, Teller and Fermi selection rules. Even in the present situation, most of the article stands unchanged and serves as a good introduction to the earlier work. The other two theoretical articles deal with the inelastic scattering of fast neutrons and with

nuclear size. A considerable amount of work has been done in both fields in the past few years. Two completely new electrical methods have been used to determine nuclear radii. Both yield a value  $r_0 = 1.2 \times 10^{-13}$  cm.;  $r_0$  is a constant in the equation for the nuclear radius,  $R = r_0 A^{1/3}$ , ( $A$  being the number of nucleons in the nucleus). About four years ago  $r_0$  was believed to be  $\sim 1.46 \times 10^{-13}$  cm. A discussion of the concept of nuclear size as determined by different methods shows that there is consistency amongst the various values.

The majority of articles in this and in previous volumes of this journal have been written by scientists from the U.K. Atomic Energy Research Establishment, Harwell. This is an indication of the trend to shift nuclear physics from Universities and concentrate it at Harwell.

M. G. K. MENON.

---

Phenazines. By G. A. Swan and D. G. I. Felton. (Interscience Publishers, New York), 1957. Pp. xix + 693. Price \$22.50.

The eleventh volume of the *Chemistry of Heterocyclic Compounds* in the series edited by Weissberger consists of two parts; the first covers phenazines and their quaternary salts, and the second deals with compounds in which carbocyclic or heterocyclic rings are fused to the phenazine nucleus. General methods for the synthesis of phenazine and its derivatives are outlined in Chapter I. Homologues, hydrogenated derivatives, and substitution products are listed and treated briefly in the succeeding chapters. The Safranines, Indulmes, Nigrosines, Aniline Black and Indanthrone have received adequate attention in other books and might well have been omitted from the present volume. The statement (p. 163) that Willstätter's view of the structure of Aniline Black is incorrect may be contrasted with Sir Robert Robinson's appraisal of Willstätter's work on Aniline Black (*J. Chem. Soc.*, 1953, 1008). The Addenda contain an uncritical abstract of Wyman's interpretation of the infrared spectrum of indanthrone; the structure proposed by Wyman for indanthrone is open to several serious objections. The chapters on bacterial pigments and the biological properties of phenazines are well written and constitute a valuable part of the book; the more recent and important work of Barry on the phenazine pigments obtained by oxidation of 2-amino-diphenylamine derivatives and their antitubercular activity (*J. Chem. Soc.*, 1956, 888; *Ibid.*, 3347) has been included in the Addenda, but

a further reference may be added (*J. Pharm. & Pharmacol.*, 1956, 8, 1089). Barry's note on a new series of phenazines ("rimino-compounds") with high antitubercular activity (*Nature*, 1957, 179, 1013) appeared too late for inclusion.

Chapter XII has sections on 5:12-diazanaphthacene and its derivatives, although these have been treated in C. F. H. Allen's volume in the same series. The main part of this chapter and the next two chapters give a very useful and comprehensive account of benzo[a]phenazine and its derivatives. Polybenzophenazines are similarly covered in the next two chapters. The two concluding chapters compile information on phenazines condensed with heterocyclic systems. An error in Allen's book (p. 39) has been corrected, but there is no reference to the paper in which the Wohl-Aue reaction between 1-naphthylamine and 2-nitroaniline was correctly interpreted (Cook and Hunter, *J. Chem. Soc.*, 1953, 4183).

The literature has been covered conscientiously and thoroughly, and the result is a very useful book of reference. The general impression one has is that material available in Beilstein and Chemical Abstracts has been collected and classified. Critical comments have been made on many reactions, and attention has been drawn to likely errors in the older literature, but more space could profitably have been devoted to the interpretation of data and the discussion of reaction mechanisms.

The production is lavish: larger letters, wider spacing, and better paper than in some of the other volumes of the series have been used.

K. V.

---

**The Harvey Lectures, 1955-56. Series LI.** (Academic Press, Inc., New York; Asia Publishing House, Bombay-1), 1957. Pp. xv + 298. Price \$ 8.00.

The diffusion of scientific knowledge in selected chapters of anatomy, physiology, pathology, bacteriology, pharmacology and physiology—the main object of the Harvey Society Lectures—has been amply fulfilled by the presentation of this volume. Main features of these lectures are outlined below:

Eccles by examining in detail the relationship of excitatory post-synaptic potential (EPSP) as recorded intracellularly to the generation of impulses by the motoneurone and the inhibitory post-synaptic potential (IPSP) has given an account of the mechanisms involved in these fundamental reactions of the nervous system.

In "Nucleic Acids and Protein Synthesis", Dr. Gale deals with experiments carried out by his group with sonic extracts of staphylococci to elucidate the template theory of protein synthesis and with their success in separating a number of "amino acid incorporation factors" from ribonuclease digests of RNA.

Dr. I. F. Fruton in his lecture on "Enzyme Hydrolysis and Synthesis of Peptide Bonds" has shown that transamidation in which proteinases take part, is more significant in protein synthesis than their hydrolytic property and suggests that acyl proteinases are intermediates in protein synthesis.

In "The Chemistry of Mesodermal Ground Substances", Dr. Karl Meyer discusses the occurrence, properties and biosynthesis of the various acid mucopolysaccharides of the connective tissue. Some experiments with chondroitin sulphate on wound healing, blocked by cortisone application have been described. The structure of chondroitin sulphate B bears striking resemblance to L-ascorbic acid and may be derived from it.

Dr. E. Racker in a brilliant article reviews the work on the "Micro- and Macrocycles in Carbohydrate Metabolism" and describes their attempts at reconstruction of the cycles carried out with pure enzymes as also the occurrence of yet another cycle in yeasts and ascites tumour cells involving octulose-8 phosphate.

Ranmelkamp's studies on the biological changes of group A streptococcus during its residence in the upper respiratory tract has led him to conclude that the carrier is less likely to transmit the disease and that environmental reservoirs are not important in the maintenance of the organism in nature or in the production of the disease.

By a critical analysis of the pathogenesis of rheumatic fever and the role of humoral bodies in the production of nephritis, the author concludes that multiple closely spaced infections, age, serological typing, season or inherited susceptibility are not the major contributory causes for those complications and that primarily attention should be focussed on the biological changes induced in the organism.

Keith Porter with the aid of electron microscope, has discussed about the form and function of cells at macromolecular level and on the special arrangement of biological material on the protoplasm. The existence of an 'elastic framework' "Endoplasmic reticulum" has been unequivocally demonstrated. Structural correlation between this reticulum and the nuclea:

membrane and relationship of this system with the microsomal fraction has been postulated.

In "Bacteriophage T<sub>2</sub>—A Parasite or Organelle", Hershey puts forth a novel view of viral infection utilising Bacteriophage T<sub>2</sub>, labelled in their protein with radio sulfate and the nucleic acid with radiophosphate, as also carrying out quantitative precursor relationships between nucleic acid and protein synthesis by utilising specific inhibitors. He considers that phage precursor DNA is not formed inside phage precursor protein membranes and DNA made in the absence of viral protein synthesis is normally functional.

In a little known subject of limitless potentialities, "The Chemistry and Physiology of Bioluminescence", McElroy describes the influence of oxygen, luciferin, A.T.P., CoA and Mg<sup>++</sup> on firefly luminescence and the mechanism and control of the firefly flash by luciferase.

M. SIRSI.

---

**The Electrophysiology of the Heart.** (*Annals of the New York Academy of Sciences*, Vol. 65, Art. 6, pp. 653-1146), 1957. Price \$ 4.50.

This monograph is the result of a Conference on the Electrophysiology of the Heart held in February 1956, and supported in part by the New York Academy of Sciences.

Several of the world's best known authorities on the subject have taken part in this Symposium.

Part 1 of the Monograph deals with cellular events during the cardiac cycle.

A large number of observations on electrical measurements, chemical analysis, isotope-tracer studies and model analogues have now been accumulated and this has laid the groundwork for an interpretation of the nature of an excitable cell and its mode of action. Those properties reported for nerve and skeletal muscle have been thought in a large measure to apply to cardiac muscle as well. The obvious differences in automatism, speed of response and length of recovery that characterise cardiac tissue have posed a number of questions although no one denies that a fundamental similarity exists between all excitable tissues.

Part 2 deals with the spread of impulses through cardiac muscle. One paper in this part describes the instrumental set-up suited for the purpose of introducing electrodes into the ventricular valves and septum in such a way as to cause only minimal injury, and not alter the response of the cardiac muscle fibres

to the excitation process and also describes the experiments that have been carried out with intramural leads in dogs as well as in goats. At the end of this chapter is a report, perhaps the only one in the whole book that the clinician will find easy to read, of a panel discussion on 'anomalous atrioventricular excitation' which is a more descriptive term for the Wolff-Parkinson-White syndrome.

In Part 3 the recovery process in cardiac muscle is discussed in several papers. Holter has described the new technique of radio-electro-cardiography for the study of cardiovascular activity. There is a panel discussion on the 'U' wave and after-potentials in cardiac muscles.

In Part 4 are considered the results of the fact that the heart like all living cells of the body except those in the skin lies within a volume conductor. The characteristic features of the human volume conductor which make it so difficult to obtain uniform results in the hands of different workers have been discussed.

In the last part, the inaccurate assumptions that have so far been made in conventional electrocardiography and the improvements that may be possible are discussed.

The thorough understanding of the monograph will require a knowledge of physics with special reference to electricity that is not always found in most clinical workers. Even so the physician interested in cardiology will be able to learn a great deal from this rather tough monograph.

K. S. S.

---

**Proceedings of the Third Weed Control Conference**, Vols. I and II. (Published by British Weed Control Council, Cecil Chambers, 86 Strand, London, W.C. 2), 1956. Pp. xiv + 870. Price 2 Guineas.

The menace of weeds in cultivation and of their robbing the crop plants of nutrition and space besides contaminating the agricultural produces, has been a problem facing the farmers of the world for centuries. As a result, since centuries past considerable effort had to be expended in human labour and at much cost to keep weeds in check. The fight against weeds, until the past few decades, has been long and drawn out and the weapons used have been simple with limited effects. About the turn of the century, however, the use of chemicals to suppress weeds helped to raise the sagging hopes of farmers who were hard hit by periods of depression although the wonder chemicals so familiar to us now were still in

the offing. Calcium cyanamide, copper sulphate, sodium chlorate, sulphuric acid, were some of the precursors of more effective chemical weed-killers that were to follow. In the battle against weeds, the harnessing of organic compounds opened up a new and vast field as these offered the advantage of providing an extensive series of chemicals that were varying in effect, depending on their constitution. The discovery of growth-promoting substances and the study of their effect on plant growth combined with the stress of the Second World War made possible the revolution in weed control, which led to the findings of the herbicidal properties of substances of hormone type. MCPA and 2, 4-D blazed the trail in 1945 and since then their variants and numerous other chemicals have been pressed into service in the war against weeds.

The two volumes of the *Proceedings of the Third British Weed Control Conference* held in 1956, under review, are an impressive record of the achievements in the battle against weeds. The discussions cover a very wide range of topics such as weed-killers in relation to efficient food production, factors influencing acceptance of new techniques by farmers, weed control equipment, weed ecology, chemical weedicides, such as the Dinitrophenols and Phenoxybutyric groups, application techniques, crop desiccation, eradication of weeds such as wild oats, *Juncus* sp., annual and perennial grass feeds, Braken, rush, etc., application of herbicides to control weeds in crops such as cereals, forage legumes, peas, vegetable and fruit crops and in forest nurseries, besides the consideration of more important aspects such as those of development of resistance or tolerance to herbicides and the effect of weedicides on animal life.

The discovery of herbicides of hormonal type have not only solved but have created attendant problems such as that of 'spray drift' which can cause damage to crops at considerable distance, injury to main crops, economics of application, differential varietal responses of a crop to the same dose of same weed-killer, etc.

It is difficult to single out any of the papers as more important as most of them furnish information of some importance or other. In his paper, Sir John Russel makes a wide survey of the problem of control of weeds in relation to efficient food production and points out that even with all the modern techniques that would be brought into play including the possibility of automation invading the garden and the

farm, "the husband man's path will always be beset with troubles".

The perusal of the papers included in the two volumes of the proceedings shows that the chemical control of weeds is not an easy and a straightforward method as it was thought at first but that it is highly complex as it leaves a number of attendant problems unsolved. As expressed by one of the contributors to the proceedings, "Altogether a great deal of research is required if we are to develop these new chemicals so that they can be of greatest use to the agricultural industry in this country." Even though this remark is meant for Britain it is equally applicable to any other country. There is no doubt that in future weeds will be controlled more and more by chemical methods but there yet remains much to be done to reduce the methods into common standard practices which could be adopted by farmers with confidence.

The two volumes contain a great deal of information which not only will interest but would be found useful to workers in the field of weed control.

L. S. S. KUMAR.

---

**Plant Virus Serology.** By R. E. F. Matthews. (Cambridge University Press), 1957. Pp. 1-128. Price 27 sh. 6 d. net.

The book is rightly described as a descriptive survey of experimental methods for serologists with practical instructions. With a large expansion of acreage of clonally propagated crops in India such as potatoes, sugarcane and fruit trees like apple, peaches, etc., the need for certification of seed stock against virus diseases is becoming very important. Serological methods developed for medical research have been used for detecting plant viruses in seed stocks on a commercial scale. The need for a book giving all details of methods of handling serological studies of plant viruses has always been felt by the plant pathologists and the present book by Dr. Matthews has amply fulfilled the requirement. The book is divided into 11 chapters, each chapter giving details of the procedures. Starting from the methods of preparation of viruses and antisera and the types of serological tests, details are given for the routine testing of virus infection. Chapter 5 deals with serological tests for determining relationships among plant viruses. The list of viruses which have given negative results in serological tests are listed on page 42. To the list of 18 viruses given by the author, several more may be added from published

papers which indicate that while serological tests are aids in detecting viruses and their relationships, they are not always absolute. Chapter 6 deals with various aspects of precipitation reaction used for detecting virus relationships. Methods of determination of titres of antibodies in the serum and methods for estimating virus concentration are outlined in Chapters 7 and 8. Cross-absorption procedure and precipitation in mixed systems are outlined in Chapters 9 and 10. In the last chapter on the applicability of serological techniques, the author enumerates possible causes of failure to obtain positive serological tests. He states that there are 170 other viruses to which this method has not been applied. Some very valuable suggestions are made for obtaining positive serological tests. Even though the book deals chiefly with plant viruses, the details of the subject treated are so lucid and practical, that it would be of immense value to all workers researching into serology, including students of medicine.

M. J. N.

#### Books Received

- The Chemistry of Natural Products*, Vol. I. (*The Alkaloids*.) By K. W. Bentley. (Interscience Publishers, New York; India: Asia Publishing House, Bombay-1), 1957. Pp vii + 237. Price \$ 4.00.
- Report of the Symposium on Magnetism, 1954*. (Indian Association for Cultivation of Science, Calcutta-32), 1957. Pp. vi + 232. Price Rs. 7.
- New Frontiers of Knowledge—A Symposium by Distinguished Writers, Scholars and Public Figures*. (Public Affairs Press, 419, New Jersey Ave. Washington-3, D.C.), 1957. Pp. x + 125. Price \$ 2.75.
- Pioneering in Industrial Research—The Story of the General Electric Research Laboratory*. By Kendall Birr. (Public Affairs Press, Washington-3, D.C.), 1957. Pp. vii + 204. Price \$ 4.50.
- Physics in Industry—Pressure Measurement in Vacuum Systems*. By J. H. Leck. (Chapman & Hall, London, for The Institute of Physics, 47, Belgrade Square, London, S.W.1), 1957. Pp. 144. Price 30 sh.
- Tracer Applications for the Study of Organic Reactions*. By John G. Burr Jr. (Interscience Publishers, New York.) Pp. x + 291. Price \$ 7.50.
- Control of the Plant Environment*. Edited by J. P. Hudson. (Academic Press, New York 3, N.Y.), 1957. Pp. xvi + 240. Price 42 sh.
- Yeasts*. Edited by W. Roman. (Dr. W. Junk Pub., The Hague, Netherlands, 13, Van Stolkweg), 1957. Pp. 246. Price 25 guilders.
- Hormones. Brain Function and Behaviour*. Edited by Hudson Hoagland. (Academic Press Inc., New York; India: Asia Publishing House, Bombay-1), 1957. Pp. 257. Price \$ 7.00.
- The Grassland and Fodder Resources of India*. By R. O. Whyte. (The Indian Council of Agricultural Research, Queen Victoria Road, New Delhi), 1957. Pp. iii + 437. Price Rs. 16.
- Interscience Monographs in Physics and Astronomy*, Vol. I. (*The Fundamental Constants of Physics*.) By E. R. Cohen, K. M. Crowe and J. W. M. Dumond. (Interscience Publishers, New York), 1957. Pp. xii + 287. Price \$ 7.50.
- Pure and Applied Mathematics*, Vol. IV. (*Water Waves*.) By J. J. Stoker. (Interscience Publishers, New York.) Pp. xxviii + 567. Price \$ 12.00.
- Advances in Enzymology and Related Subjects of Biochemistry*, Vol. XIX. Edited by F. F. Nord. (Interscience Publishers, New York; India: Asia Publishing House, Bombay-1), 1958. Pp. v + 457. Price \$ 9.85.
- Flame Photometry—A Manual of Methods and Applications*. By F. Burriel Marti, J. Ramirez Munoz. (Elsevier Pub. Co., 31, Wright's Lane, London W.8), 1958. Pp. xii + 531. Price 65 sh.
- The Measurement of Colour*. By W. D. Wright. (Hilger & Watts Ltd., London N.W. 1), 1958. Pp. ix + 263. Price 52 sh.
- Encyclopedia of Chemical Technology*. Edited by Raymond E. Kirk and Donald F. Othmer. (Interscience Publishers, New York 1; India: Asia Publishing House, Bombay-1), 1958. Pp. xviii + 974. Price \$ 25.00.
- Structure Reports for 1951*, Vol. 15. Edited by A. J. C. Wilson. (N. V. A. Oosthoek's, Doms-trat, Utrecht), 1958. Pp. viii + 588. Price \$ 29.
- Chronica Botanica*, Vol. 17. (*The Experimental Control of Plant Growth*.) By Frits W. Went. (The Ronald Press Co., New York 10, N.Y.), 1958. Pp. xvii + 343. Price \$ 8.50.

---

---

## SCIENCE NOTES AND NEWS

---

---

### New Standard of Length

The Advisory Committee for the Definition of the Metre, headed by L. E. Howlett, Director of the Division of Applied Physics, National Research Council of Canada, has unanimously agreed on a new standard of length—a wavelength of light—to be used instead of the platinum-iridium bar kept at Sevres, France. The leading contenders as the source for light for the standard have been the following isotopes: mercury-198, krypton-84, krypton-86 and cadmium-114. One of the wavelengths of orange light emitted by krypton-86 has been selected as the standard, and the international meter will be defined as 1,650,763.75 times this wavelength. The resulting standard will be more than 100 times as precise as the present international meter.

Although in practice the new standard is already in use, several steps remain before the wavelength becomes officially recognised. The Committee mentioned above will send its recommendation to the International Committee of Weights and Measurements for consideration at its Meeting in October 1958; when approved there, the recommendation will be presented to the International Conference on Weights and Measures, which will meet in 1960; at that time the standard will become the legal international standard. (*Science*, Jan. 1958.)

### Using Free Radicals

Ordinarily, free radicals exist only for very short periods in systems such as flames, electric arcs and hot gases.

Numerous methods have however been developed for capturing and storing them mainly at low temperatures. N.B.S. workers have frozen the products of an electric discharge at a few degrees absolute, capturing some types of free radicals in highly excited states and making it possible to study them, including analysing them spectroscopically. This opens a whole new field of low temperature chemical kinetics which, in principle, offers prospects for a very significant effect on industrial chemical processes. It is hoped that with free radical stabilization processes, it may be possible to synthesize new materials, to improve the yield in the synthesis of materials that have been pro-

duced in other ways, and perhaps even to provide better control over various industrial processes. However, the work is still at an early stage and the details of the mechanisms by which the results may be achieved have yet to be discovered.

### Corrosion and Chemistry

The above theme will be discussed at the Second Congress of the European Federation of Corrosion which will take place in Frankfurt (Main) from 5th to 8th June 1958 within the framework of the European Congress of Chemical Engineering, 1958. Forty-eight technical and scientific societies in 15 countries are members of the European Federation of Corrosion.

Corrosion is of particular importance in chemical technology because many of the materials handled in this branch of industry are characterized by their extremely aggressive properties. The high temperatures which are frequently employed also favour corrosion. For this reason a large number of special structural materials have been developed for use in the chemical industry and many processes have been devised for the protection of the surface of materials of construction.

Protection from corrosion is also within the province of the chemist. Apart from the possibilities of special types of construction used to prevent damage, the chemist is often able to combat corrosion by producing new structural materials and protective surface coatings. He is also able to devise methods of testing and measurement which can be used for determining the rate of destructive processes by standardized techniques, with a view to selecting the most suitable type of protection from corrosion.

This field, which is of such economic and scientific importance, will be covered by 6 plenary lectures and 48 papers, followed by discussions which will be presented by representatives from 12 countries from 5th to 7th June 1958.

The programme and an invitation to take part in the Congress may be obtained free of charge from the Congress Business Office: Gesellschaft Deutscher Chemiker, Frankfurt (Main) Haus der Chemie, Karlstr. 21.



### Lysine Supplemented White Rice

The improvement in nutritive quality of the protein of a food or feed, attainable by amino acid supplementation, is dependent upon many factors. These include the recognition of the essential amino acid requirement of the species or individual which is to benefit from the improved protein and the amino acid composition of the food to be improved. Application of these sound principles has been rewarding in several instances.

The nutritive value of the protein of white polished rice can be improved significantly by supplementation in the first limiting amino acid, lysine in amounts sufficient to bring this amino acid in balance with the second limiting amino acid. Growth responses in rats fed with lysine supplemented rice were found to be very satisfactory (*Jour. Nutrition*, Vol 63, 1958, 477).

### Spotted Wilt Disease

Spotted wilt is a virus disease which attacks plants most seriously during the spring, summer and autumn. Young, vigorously growing annuals are often rapidly killed or so severely stunted that they become worthless. On the other hand, perennials may tolerate the disease to greater or less extent, some being stunted and of poor vigour while others show little or no effect.

Plants which are known to be attacked by the virus include amaryllis, anemone, arum lily, aster, calceolaria, calendula (marigold), Canterbury bell, chrysanthemum, cineraria, dahlia, gailardia, gerbera, happeastrum, Iceland poppy, *Lillium* spp., nasturtium, petunia, phlox, salpiglossis, schizanthus, snapdragon, sweet pea, veronica and zinnia. The disease also occurs in lettuce, potato, tobacco and tomato and a large number of weeds.

Diseased plants can mostly be recognised by abnormalities which develop, in the leaves, although the symptoms vary according to the kind of plant affected.

The spotted wilt virus loses its infective powers very rapidly when plant tissue, in which it is growing, is injured. As a result

it is seldom, if ever, transferred from a diseased to a healthy plant during pruning or other cultivation methods in the field. It is also quite common to find a healthy plant such as a tomato, growing intertwined with one severely affected with spotted wilt.

All available evidence suggests that the only means by which this disease spreads naturally is when it is carried by a small insect, the thrip.

The virus enters the thrip when it is feeding on infected plants and, if the thrip has not yet reached its adult stage, the virus remains alive and possibly multiplies in its insect carrier. So far as is known the thrip is not inconvenienced in any way but retains its power to inoculate plants throughout its subsequent adult life.

Any plants known to be infected should be destroyed and insecticides should be used at frequent intervals in an endeavour to keep the population of thrips at the lowest possible level (*Agri. Gaz. of N.S.W.*, Jan. 1958, 69, 33).

### Sir Dorabji Tata Gold Medal (Third Award)

The Third Award of the Sir Dorabji Tata Gold Medal of the Zoological Society of India will be made for the best research work in any branch of Zoology, published during the three-year period 1955, 1956 and 1957.

As it is not possible for the Society to compile a list of Zoological publications of all workers in India, the authors are requested to send one copy of each of their publications during the period 1955-57, to enable the Selection Committee to make a suitable choice. The reprints will be kept in the library of the Society.

Reprints should be sent so as to reach Prof. M. L. Roonwal, President, Zoological Society of India, 34, Chittaranjan Avenue, Calcutta-12, before the 30th of June 1958.

### CORRECTION

Vol. 27, No. 1, p. 23, note on "Pyrolysis and Ignition of Wood", the figure in column 3 of Table I should read 228° C. instead of 268° C.

384-58. Printed at The Bangalore Press, Bangalore City, by C. Vasudeva Rao, Superintendent, and Published by A. V. Telang, M.A., for the Current Science Association, Bangalore.

All material intended for publication and books for review should be addressed to the Editor, *Current Science*, Raman Research Institute, Bangalore-6.

Business correspondence, remittances, subscriptions, advertisements, exchange journals, etc., should be addressed to the Manager, Current Science Association, Raman Research Institute, Bangalore-6.

### ANNUAL SUBSCRIPTION

India: Rs. 8-00. Foreign: £ 0-16-0. \$ 2.50.

## APPLICATIONS OF ULTRASONIC VIBRATIONS\*

E. G. RICHARDSON

*Professor of Acoustics, University of Durham, England*

**T**HESE vibrations though possessing the same physical characteristics as sounds have frequencies so high that they fall outside the range of pitch to which the human ear is susceptible. It is well known that as the pitch of a sound goes up it eventually becomes inaudible when its frequency is about 20,000 vibrations per second. There is no theoretical upper limit to the ultrasonic frequency though with existing means, experiments are limited to the range 20 kilocycles to 50 megacycles per second.

Most of the applications to which I shall refer make use of sources working on the piezo-electric or the magnetostriction principle. The former is an adaptation of an effect discovered by the brothers Curie, *i.e.*, that certain crystals, when compressed along one of their axes, develop charges on these or other faces and *vice versa*. If now an alternating potential difference is applied across one pair of faces, compressions and contractions of the crystal follow at the same frequency. The effect will be most manifest when the exciting frequency corresponds to one of the natural frequencies of vibration of the crystal, determined by its length in the particular direction of expansion and contraction, and the velocity of sound in the material. Such a piezo-electric resonator was first realised by Langevin in 1917; he used slabs of quartz and applied the necessary potential difference through a thermionic valve oscillator.

The substances most commonly used as sources in this way are quartz, Rochelle salt and tourmaline. They are cut into discs or slabs in such directions that electrodes may be applied to carry potential in the direction of one of their crystalline axes. In the case of the slabs, the electrodes are cemented to the top and bottom and the extensions and contractions take place along the greatest dimension. The discs are usually cut so that the motion takes place in the same direction as the applied alternating potential, namely, perpendicular to the flat face (in concertina fashion). The natural frequency is inversely related to the thickness of the disc, about 2.5 cm. for 100,000 c./sec.; 2.5 mm. for 1,000,000 c./sec. in quartz.

The magnetostriction oscillation is induced by a current of the requisite frequency through a coil wrapped round an iron or nickel rod, causing variations in length as the magnetic field strength alternates.

Either of these latter types of source is capable of sending out ultrasonic waves into the fluid medium in which it is placed, of sufficient energy for most laboratory experiments. In certain applications, however, a larger radiating surface is required than can be obtained from the face of a single crystal or nickel rod. In order to achieve this, Langevin constructed a sort of sandwich consisting of a large number of little slabs side-by-side and all having their axes of vibration parallel between two metal slabs to act as electrodes. By the concurrence of crystals vibrating together the lower plate was made to move relative to the top one, and thus a large radiating area was added to the source, when working into water. It is also possible to construct a bowl-shaped oscillator made of a mosaic of crystals so that a large ultrasonic intensity is produced at the focus (Fig. 1).

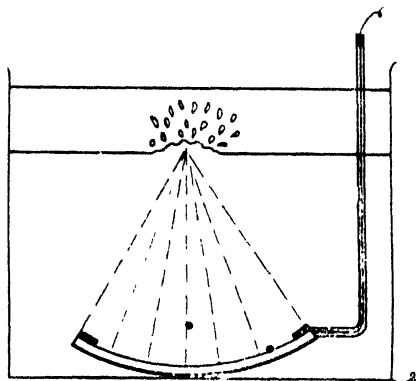

FIG. 1. Bowl type of ultrasonic source focussing sound energy at the surface of a liquid.

In the case of the magnetostriction oscillators a number of rings threaded together have coils wrapped round them so that they all expand and contract round their circumference in unison. The energy is received on the surface of a metal horn, so that the radial oscillations are turned through a right angle and

\* Based on lectures given at a number of Indian Universities in December 1957 and January 1958.

sent out from the horn in the form of a beam (Fig. 2).

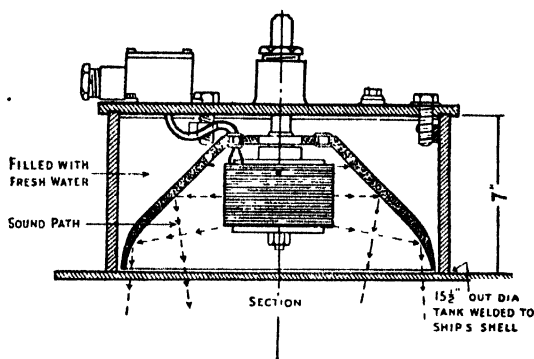

FIG. 2. Magnetostriction source reflecting energy from a metal horn into a liquid.

The applications of ultrasonics on a larger scale fall under two heads. There are those which make use of the energy of the high frequency vibration which can be induced by their aid to agitate various materials, both inorganic and organic. Others use the principle of echo-detection by which a beam of ultrasonics is made to pulse towards a suspected obstacle, to be reflected there and caught on a suitably-tuned receiver. In this latter use a source of high frequency is essential, as we shall see, but many of the perturbation methods could be equally well carried out with a source of lower frequency. The advantage here of the ultrasonic source is in its compactness and the fact that the intense vibrational energy can be concentrated into a small region, a thing which would be difficult to do with a source of lower frequency. On the other hand, this feature prevents many successful small-scale experiments being copied on an industrial scale, except with much duplication of the apparatus and at considerable expense.

Of industrial applications in the first class, I shall mention the formation of emulsions, the coagulation of smokes and the degassing of melts. It is readily observed that when a quartz oscillator is set in intense vibration under oil the liquid, particularly at the surface, is set into violent agitation; in fact, the liquid may rise above the surface in a fountain which disperses fine oil drops as a foam above it (Fig. 3). Place a lighter liquid above the one in which the oscillator is working and you disperse one into the other as an emulsion. This process is sometimes used in the manufacture of photographic emulsions, as it is found that a finer grain results. If an ultrasonic emitter is placed at the base of a

glass chimney to which tobacco smoke or a water mist has been disseminated, the particles are agitated and brought into collision more frequently than otherwise. This causes coalescence and the larger particles so formed soon drop to the floor of the chimney. It is necessary that the final resting place of the liquid or solid forming the smoke shall be screened from the radiation, otherwise a certain amount of re-dispersal results.

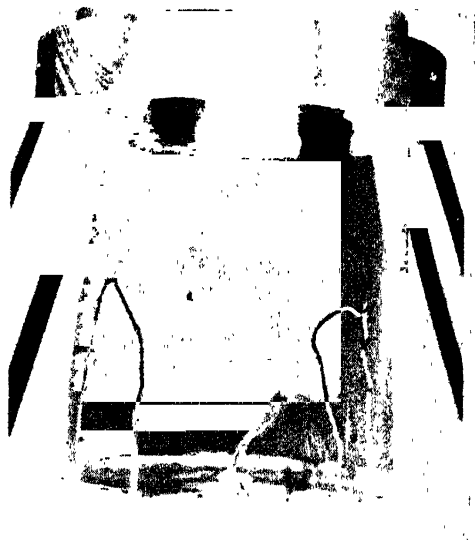

FIG. 3. Bowl type of source producing a fountain at the surface of a liquid.

Gas bubbles suspended in molten metals may similarly be brought to the top and out of suspension. In casting molten metal, such bubbles may be occluded and serve to weaken the structure after solidification. It is also possible to clean textiles immersed in water, as in laundering, by agitating the water ultrasonically. This removes dirt and fat.

For some years it has been known that it is possible to tin aluminium and its alloys by subjecting their surface to the action of intense ultrasonic vibration at the same time as molten solder is applied. It is now established that the process is one of removing the oxide skin by cavitation erosion. When, however, the experiment was repeated with an ambient pressure of 4 atmospheres, tinning was completely prevented. Since the increased pressure can have had only a negligible effect on any factor other

than cavitation, this seems convincing evidence of the essential part played by the latter.

Aluminium is known to have a low resistance to cavitation erosion, even in water, so it is not surprising that collapsing voids in molten solder will be able to disrupt the surface, exposing the aluminium underneath for alloying with the metal which is impinging violently against it in the very action of cavitation. We can expect, moreover, that the usefulness of the ultrasonic technique for tinning different 'difficult' metals will be related to their susceptibility to cavitation erosion.

The detection of underwater obstructions by the echoes which they send back to a ship was the first application of ultrasonics and the *raison d'être* of the Langevin quartz 'sandwich'. Although too late for much use in the First World War, the apparatus under the name of Asdic was of great service for detecting submarines in the Second. It is well known that between the two wars, a device on the same principle using electromagnetic waves was developed, under the name of radio-location or radar, to detect obstacles in the air. Owing to the great absorption, which the latter suffer in water, ultrasonic waves must be used in the sea. It is interesting to note that high-frequency sound waves were suggested in a patent by Dr. L. F. Richardson for the detection of the submerged portion of icebergs after the *Titanic* disaster, but the means of producing them in sufficient power were wanting until Langevin's invention.

Unfortunately, the similar elastic properties of ice and water prevent a good echo being obtained off an iceberg, but the ultrasonic echosounder has now become a common piece of equipment for hydrographic surveying, both for delineating the bed of the sea when pointed downwards from the survey ship, or pointing upwards from the harbour bed to measure tidal-height or even wave height. With the former arrangement even a shoal of fishes can be detected.

Another factor which must be reckoned with is the increasing absorption which sound waves suffer in a fluid as the frequency is pushed up. This can be noticed by anyone who has used underwater listening equipment. When a hydrophone is laid at some distance from a ship the low-frequency engine noises and hull vibrations predominate. This factor combined with the diffraction we have already noted sets the optimum frequency for under-water echo sounding at about 20 kc./sec., just above the audible limit.

In use the magneto-strictive oscillator in its horn-like housing is turned either vertically downwards, if it is the sea-bed which is to be detected or roughly horizontally and scanned round in a circle by rotating the housing if, e.g., submarines are being looked for, just as a radar beam is scanned round the horizon from the transmitter-cum-receiver aerial.

For the detection of flaws in the form of hairline cracks in metals, a system has been developed by the firm of Hughes in England in which a short train of waves is sent out and its wave form, as recorded by the receiver, noted on a cathode-ray oscillograph. They use quartz oscillators sometimes one at each end of an ingot (transmission method); sometimes on two facets of a prismatic specimen (reflection or echo-sounding method). The presence of hair-line cracks is shown in the latter method by a number of secondary echoes which reach the second quartz before the main reflection from the base of the prism (Fig. 4). Whereas

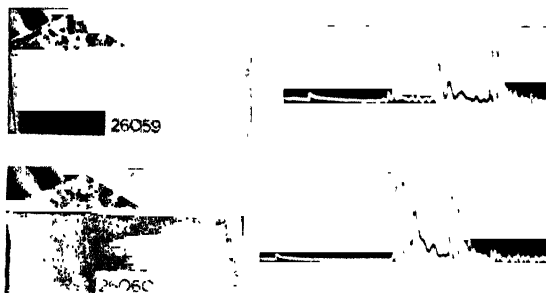

FIG. 4. Detection of flaws in a metal ingot. The echoes from these and from the base of the ingot are shown in the cathode-ray oscillograph displays on the right.

large fissures may be more readily detected by X-rays, the ultrasonic method is better for spotting these tiny cracks since it needs but the narrowest break in the continuity of the metal to give rise to a secondary reflection.

Formerly the velocity of sound in a gas was thought to be independent of frequency, the fact that the music of an open-air band is not distorted by distance being cited as proof. Soon after the discovery of ultrasonic quartz sources by P. Langevin, however, G. W. Pierce noted that at a frequency of about 100 kc./s. a rise of velocity occurred in carbon dioxide, accompanied by a considerable absorption of the energy. Following an idea which Debye had already pursued with success in explanation of the variation of dielectric constant with frequency, Herzfeld and Rice suggested that this

was an acoustic relaxation involving the transfer of translational into vibrational energy and taking time in the process. In other words, above a certain frequency there is not time for this transfer to take place and the molecules become effectively stiffer, hence the rise in velocity of propagation and the change in phase between pressure and particle velocity which results in the attenuation of the ultrasonic signal as it passed through the gas. This behaviour is characteristic of a system which possesses a single relaxation time for the transfer of translational into vibrational energy.

In the succeeding twenty-five years, similar relaxations have been discovered in other gases, though none so pronounced as in carbon dioxide. Fig. 5, for example, shows a vapour in which this rise in velocity of sound accompanied by enhanced absorption occurs at a certain value of the parameter (frequency/pressure), for it is found that the relaxation time is inversely proportional to the pressure on the gas.

The subject has received attention in recent years from workers in aerodynamics who are looking for vapours capable of being substituted for the air in supersonic wind tunnels. These should have a low velocity of sound in order that high Mach numbers may be reached without excessive tunnel speeds. Possible vapours for this purpose are the freons and the hexafluorides, and work is going on in the author's laboratory on these vapours, with such aerodynamic applications in view (cf. Fig. 5).

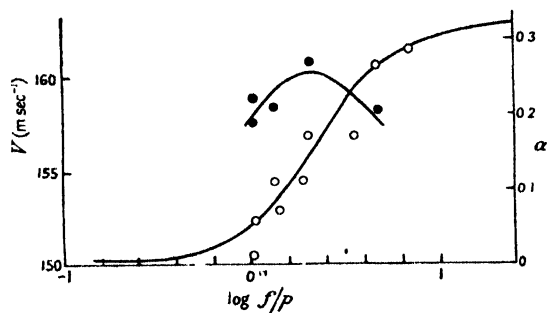

FIG. 5. Variation of velocity of sound  $V$  ( $\circ$ ) and absorption  $\alpha$  ( $\bullet$ ) in freon exhibited in terms of frequency/pressure.

If, as is apparent, their molecules can relax at lower frequencies than those of oxygen or nitrogen of the atmosphere (which scarcely show relaxation within yet attainable ultrasonic frequencies), then shock waves initiated in them may not properly reproduce conditions in the atmosphere. When a shock wave passes through a relaxing gas, the density does not

immediately take up its new value. A photograph taken with an optical interferometer will then show (in the interference bands) the gas adjusting itself exponentially to the new conditions, instead of instantaneously (cf. Fig. 6, which refers to carbon dioxide).

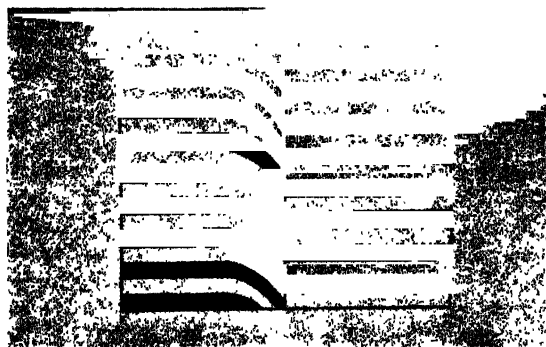

FIG. 6. Passage of shock front in carbon dioxide. The black lines are the diffraction bands seen in an optical interferometer.

In liquids, relaxations in the sense of anomalous absorption accompanied by a rise in velocity of propagation have not been definitely established since, within the limits of precision of present experimental technique, no dispersion of velocity with frequency has been established (except in acetic acid). This is not to say that the attenuation of the wave is normal in the sense that it is proportional to the kinematic viscosity of the liquid in the way that the 'classical' formula of Stokes would have it be. In fact, although in many liquids the quotient: (absorption coefficient)/(frequency)<sup>2</sup> is a constant as it should be (and which precludes relaxation on the simple theory), this constant is in very few cases the Stokesian one, for instance, in benzene it is 600 and in carbon disulphide 1,000 times the expected value on the basis of shear viscosity. It has been suggested by the author that this effect is connected with the ease of formation of cavitation nuclei in these liquids which have high vapour pressures. Others ascribe it to a form of compressional viscosity, peculiar to the propagation of ultrasonic energy.

The molecules of solid bodies, being more restricted in their movements, show usually a spectrum of relaxation times spread over the whole gamut. The disentanglement of these and their ascription to various causes is a major problem to the physical metallurgist and his fellow worker in high polymer studies.

This molecular friction must be related to things which can be directly measured. These are (a) the decrement of amplitude of forced vibrations, and (b) the reciprocal width of a resonance peak under forced vibration. In a number of materials available in the form of cylinders, transverse oscillations may be excited by clamping one end and attaching an iron inertia bar to the other which is then set in motion by external magnets. As the range of frequency of the experiments is raised, the

investigator usually replaces flexural vibrations by torsional vibrations. It is often more convenient to vary the temperature than the frequency. In general the internal friction will fall as the temperature rises, though it rises in glass. If there is a relaxation peak in the infrasonic range it will usually shift with temperature, so that at a given temperature the substance will have a loss which represents some point on the peak.

---

## ROCKET-FIRING CONTRIBUTION TO GEOPHYSICAL YEAR

COMPARED with the amount of attention given to satellites, the firing of 120 or so rockets as contributions to the International Geophysical Year has passed largely unnoticed. Yet a preliminary review of the scientific information obtained from 81 research rockets launched by the U.S.A. between July 1, when the I.G.Y. began, and November 30 shows that much of interest has been learnt, especially from northern and Arctic firings.

The American northern firings have been from a rocket base set up by Canada at Fort Churchill on Hudson's Bay. This is more favourably placed than might be supposed. Although no farther north than John O'Groats it is only some 900 miles from the North Magnetic Pole. It is therefore well placed for the study of those effects which are produced on the earth by the arrival of electrically charged particles from the sun; since, influenced by the magnetic field of the earth, they follow spiral paths towards the regions of the two magnetic poles. Firings within the Arctic circle were made from shipboard, using the "rockoon" method, in which the rocket is fired by radio signals from below a balloon.

### ROCKOON

A result of the "rockoon" firings was that "an excellent survey was made for the first time of auroral particles"—which are known to include protons, otherwise hydrogen nuclei, ejected from the sun—"and their association with actual auroræ". This is one of several points about auroræ on which there have been gaps in knowledge. In principle it should be possible to correlate the forms and development of auroræ with the distribution of incoming particles. But to do this completely, even for one area, would require a very large number of rockets.

A total of 18 "rockoons" was fired during the American Arctic cruise, and 36 in a similar operation which was carried southwards from the Pacific into Antarctic waters. The southern cruise was, however, completed too late for the present summary.

One object of firings from Fort Churchill was to explore conditions in the ionosphere during a polar radio black-out—an effect which was first established during the International Polar Year of 1932-33 through an expedition led by Prof. Sir Edward Appleton to Tromsø, in Norway. Rocket measurements, made apparently by two different methods, have now confirmed that the cause of such sudden lowering of the D-region of the ionosphere—the lowest of the (normally) radio-reflecting regions of the atmosphere.

Other firings had as their object the collection of information about the pressure, temperature and density of the air above Fort Churchill. They were carried out in different months, by night as well as by day, and at heights of up to 125 miles. A general effect was to show that the density of the air at the greatest heights was much more strongly controlled by the sun than above New Mexico, where most previous research rockets have been fired. "There appear to be a latitude effect, a seasonal effect, and a strong diurnal effect; none of these effects appears at lower altitudes at Fort Churchill or at lower latitudes." Temperatures in the stratosphere were found to continue rising up to greater heights—37 miles, compared with about 30 miles—than in lower latitudes.

Another experiment is thought, provisionally, to provide the first evidence of the beginning of a sorting out of the gases of the atmosphere on the basis of density, as height is increased.

There are two grounds in this for interest. One is that a sorting out of this kind implies that the atmosphere is no longer being stirred effectively; that the limit of air movements which may be connected with weather below has been reached. The other is in relation to the past and present history of the atmosphere; since the lighter a gas is the more readily must it escape from the earth.

#### "ELECTRO-JET"

Evidence for such a sorting out has been sought, but not confirmed, at lower latitudes. In the First Churchill measurements, a census of the atoms and molecules present in the air at different levels was taken with a mass spectrometer. There is an element of interpretation in such measurements, admittedly. The conclusion, cautiously expressed, is that at the latitude of Fort Churchill (58° 40' N.) the gases of the atmosphere appear to be well mixed up to about 100 kilometres (about 62 miles), but that above this there is a beginning of separation under gravity.

The summary of American measurements that has been quoted covers also other forms of research. One that is of interest, and to some extent related, is an attempt to confirm from magnetic stations at ground level the existence of the so-called equatorial "electro-jet". The effects observed in magnetic storms are thought to be connected with great electric currents, of perhaps several hundred thousand amperes, circulating high in the atmosphere. Two of these currents are thought to circle the North and South Magnetic Poles. A third, round the magnetic equator, is thought to become narrowed at local noon, so that the density of current is increased, the effect at ground level being then greater.

A chain of stations has been set up in the Pacific and South America to test the reality of the "electro-jet". The data that are being collected at all stations will need to be analysed and compared before any firm conclusions are drawn. Meantime, early data from one station, Koror, in the Western Pacific—are said to show that the electro-jet exists.

---

### EFFECT OF TERRESTRIAL MAGNETIC FIELD ON COSMIC RADIATION

**T**HERE is an appreciable difference between the characteristics of the terrestrial magnetic field obtained, on the one hand, through the study of cosmic rays and, on the other, by the measurement of the magnetic field on the earth's surface.

This is the conclusion which the Soviet scientists have arrived at, after the initial sorting out of the findings of research done with the first Soviet artificial earth satellites, Academician Topchiev, Scientific Secretary of the Presidium of the USSR Academy of Sciences, has declared.

An analysis of the number of cosmic ray particles at different latitudes and longitudes has shown that the lines of uniform intensity of cosmic rays do not coincide with geomagnetic parallels.

A study of the measurements of the intensity and variations of the intensity of cosmic rays, done with the second Sputnik, has made it

possible to determine the dependence of the number of particles on altitudes.

Academician Topchiev announced that increases of cosmic ray intensity of up to 40% had been observed in the interval altitudes of 225 to 700 kilometres. This phenomenon is believed to be mainly due to the reduction of the effect of the terrestrial magnetic field on cosmic radiation at great altitudes.

Along with this, observations have established that there are fluctuations of cosmic ray intensity which are probably associated with the state of outer space closer to earth. On one occasion a steep increase (50%) of the number of cosmic ray particles has been observed. This has, possibly, been caused by a new phenomenon, to wit, the generation of cosmic rays of very low energies on the sun which are intensely absorbed by the earth's atmosphere.

---

LIMITING POLARIZATION CURVES FOR RADIO WAVE PROPAGATION IN THE IONOSPHERE

R. N. SINGH AND Y. S. N. MURTY

Wireless Laboratory, Dept. of Physics, Banaras Hindu University

THE polarization of a radio wave propagated through the ionosphere in the presence of earth's magnetic field is usually represented by  $\theta$  and  $\psi$ . If the direction of wave propagation is along the positive direction of the X-axis of a right-handed co-ordinate system and the earth's magnetic field is assumed to be in the XZ-plane, then  $\theta$  is defined by  $\tan \theta = -j(h_z/h_y)$  where  $h_y$  and  $h_z$  are the magnetic vectors of the wave along the Y and Z axes, and  $\psi$  is the tilt of the polarization ellipse with respect to the Z-axis. In the present communication we shall discuss the limiting values of  $\theta$  and  $\psi$ , when the wave enters the ionosphere or emerges from it on retracing its path. The observed polarization of a downcoming wave is determined by these limiting values when the electron density N tends to zero.

According to Mary Taylor<sup>1</sup> (1933, 1934), the limiting polarization is given by  $\theta = \pm 45^\circ$  and  $\psi = 0$ .  $\theta = \pm 45^\circ$  means that the wave incident on the ionosphere would split up into two circularly polarized components with opposite senses and if they retrace their path they would possess the same polarization on emergence from the ionosphere as on entry into it. The calculations of Martyn<sup>2</sup> (1935) and of Ghosh<sup>3</sup> (1933) for increasing values of the electron density N in the ionosphere (with certain assigned values for the electron collision frequency  $\nu$ ) following the method given by Bailey<sup>4</sup> (1934) have however shown that as N tends to zero, the values of  $\theta$  and  $\psi$ , in the case of vertical propagation tend to certain limiting values which are not  $\pm 45^\circ$  and  $0^\circ$  and which depend on the angle between the direction of propagation and the direction of the earth's magnetic field and also on the wavelength and electron collision frequency.

The Bailey's method of conformal representation as applied to the Appleton<sup>5</sup>-Hartree<sup>6</sup> formulæ for the determination of  $\theta$  and  $\psi$ , has already been given in detail by Martyn (1935) and Ghosh (1938). We shall give here an outline of this method.

The Appleton-Hartree formulæ for the refractive index  $\mu$ , absorption coefficient  $k$  and polarization R can be written as:

$$M^2 = c^2 q^2 = (\mu - i\chi)^2 = 1 + \frac{1}{(\alpha + i\beta) - \frac{\gamma_T^2}{2(1 + \alpha + i\beta)} + \sqrt{4(1 + \alpha + i\beta)^2 + \gamma_L^2}} \quad (1)$$

and

$$R = \frac{h_z}{h_y} = \frac{1}{i\gamma_L} \left[ \frac{1}{c^2 q^2 - 1} - \alpha - i\beta \right] \quad (2)$$

where M = complex refractive index =  $cq$

$$\chi = \frac{ck}{p}$$

$$\alpha = \frac{p^2}{p_0^2} - \frac{1}{2}, \quad \beta = \frac{p\nu}{p_0^2}$$

$$\gamma_L = \gamma \cos \theta', \quad \gamma_T = \gamma \sin \theta'$$

in which

$$p_0^2 = \frac{4\pi N e^2}{m}, \quad \frac{pp_H}{p_0^2}, \quad p_H = \frac{He}{mc}$$

and  $m, e$  = mass and charge respectively of an electron

N = electron density

H = intensity of earth's magnetic field

$\theta'$  = angle between H and direction of propagation

$p$  = angular frequency of the wave

$\nu$  = electron collisional frequency.

Now eliminating  $(c^2 q^2 - 1)$  from equations (1) and (2) and denoting the value of R with the negative and positive signs as  $R_0$  and  $R_x$  corresponding to the ordinary and extraordinary components, we get

$$R_0 + R_x = \frac{i\gamma_T^2}{1 + \alpha + i\beta} = \frac{2}{x + iy} \quad (3)$$

and

$$R_0 R_x = 1 \quad (4)$$

where

$$x = \frac{\sigma\nu}{p_H}, \quad y = \frac{\sigma p}{p_H} \left( 1 - \frac{p_0^2}{p^2} \right)$$

and

$$\sigma = \frac{2 \cos \theta'}{\sin^2 \theta'}$$

The major axis of the polarization ellipse is inclined to the Z-axis at an angle  $\psi$  and is given by

$$\tan 2\psi = \frac{-2\rho \cos \phi}{(1 - \rho^2)} \quad (5)$$

and the ratio of the axes which we will call  $\tan \theta$  can be written as



$$\tan^2 \theta = \frac{(1+\rho^2) \sin 2\psi + 2\rho \cos \phi}{(1+\rho^2) \sin 2\psi - 2\rho \cos \phi} \quad (6)$$

As it is evident from equations (5) and (6) we require  $\rho$  and  $\phi$  for the calculation of  $\psi$  and  $\theta$ .  $\phi$  and  $\rho$  are calculated by Bailey's method in the following way :

Values of  $x$  and  $y$  are calculated by substituting required known data. Two circles of diameters  $x^{-1}$  and  $y^{-1}$  passing through origin and having their centres on the axis of  $\xi$  and  $\eta$  are drawn as shown in Fig. 1. The other

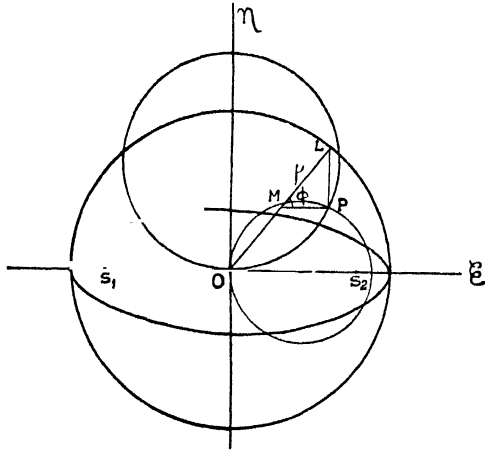

FIG. 1. Illustrating  $\rho$  and  $\phi$  in Bailey's method.

point of intersection is also the point of intersection of confocal ellipses and hyperbolæ having their focii on the axis of  $\xi$  at  $\xi = \pm 1$ . From the properties of confocal ellipses and hyperbolæ it can be shown that if P be the point of intersection, then PL drawn parallel to the  $\eta$ -axis cuts the asymptote to the hyperbola on the auxiliary circle of the ellipse at L and PM drawn parallel to the  $\xi$ -axis cuts the asymptote at M, then  $LM = \rho$  and angle  $LMP = \phi$ .

Following Bailey's method of conformal representation, we have computed the values of  $\theta$  and  $\psi$ , for  $N = 0$  for vertical propagation considering wavelengths much more and much less than the gyromagnetic wavelength for Banaras. Taking the total magnetic intensity H at Banaras on the earth's surface to be 0.446 Gauss the gyromagnetic wavelength  $\lambda_H$  for Banaras comes out to be 240.3 metres. In Fig. 2, the computed values of  $\theta$  and  $\psi$  for wavelengths corresponding to multiples and sub-multiples of the gyromagnetic wavelength are plotted for four different values of the electron collision frequency (i)  $\nu = 0$ , (ii)  $\nu = 10^6 < \nu_c$ ,

(iii)  $\nu = \nu_c$ , and (iv)  $\nu = 10^7 > \nu_c$ , where  $\nu_c$  is the critical collision frequency. The dip-angle at Banaras being  $36^\circ 26' N$ ,  $\nu_c$  comes out to be 4.49 Mc./s. for  $H = 0.446$  Gauss at Banaras.

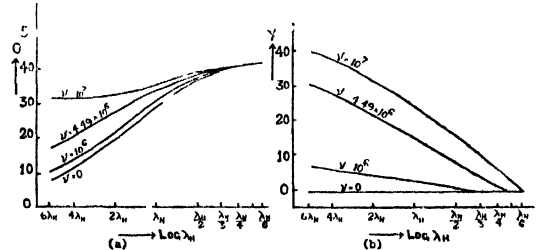

FIG. 2. (a) Variation of  $\theta$  with  $\lambda$ ; (b) Variation of  $\psi$  with  $\lambda$ .

The variations of  $\theta$  with  $\lambda$  as represented in Fig. 2 (a) show the following features: (i) The value of  $\theta$  decreases from a limiting value  $45^\circ$  to zero as the wavelength is gradually increased from a very low value to a high one. (ii) There is a wavelength in the neighbourhood of  $\lambda = \lambda_H/3$  beyond which the rate of variation of  $\theta$  with respect to  $\lambda$  is small and for  $\lambda < \lambda_H/3$ ,  $\theta$  tends to the limiting value of  $45^\circ$  irrespective of the electron collision frequency value. (iii) For a given wavelength, the rate of variation of  $\theta$  with  $\lambda$  decreases as the electron collision frequency increases. The variation of the tilt-angle  $\psi$  as represented in Fig. 2 (b) show the following features: (i)  $\psi = 0$  for all wavelengths when  $\nu = 0$ , (ii) For a particular value of the electron collision frequency,  $\psi$  tends towards zero as the wavelength is decreased. (iii) When  $\nu < \nu_c$ ,  $\psi$  becomes sensibly zero for  $\lambda < \lambda_H/3$ . (iv) When  $\nu > \nu_c$ ,  $\psi$  becomes sensibly zero for  $\lambda \leq \lambda_H/3$ . (v) For a particular wavelength,  $\psi$  increases from zero upwards as the electron collision frequency increases. It can thus be concluded that the limiting values  $\theta = \pm 45^\circ$  and  $\psi = 0$  as given by Mary Taylor are valid only when  $\lambda < \lambda_H/3$ .

Our sincere thanks are due to Prof. S. R. Khastgir for his keen interest and suggestions.

1. Taylor, Mary, *Proc. Phys. Soc. (London)*, 1933, **45**, 245; 1934, **46**, 408.
2. Martyn, D. F., *Phil. Mag.*, 1935, **19**, 376.
3. Ghosh, S. P., *Ind. Jour. Phys.*, 1938, **12**, 341.
4. Bailey, V. A., *Phil. Mag.*, 1934, **18**, 516.
5. Appleton, E. V., *U.R.S.I. Papers* (Washington), 1927.
6. Hartree, D. R., *Proc. Camb. Phil. Soc.*, 1931, **27**, 143.

LIPOPROTEIN CHOLESTEROL IN CORONARY DISEASE AND ANAEMIA

PARAMJIT R. PABRAI AND K. B. SEHRA

Armed Forces Medical College, Poona-1

QUALITATIVE and quantitative changes in lipid components of blood, particularly of lipoproteins, in various pathological conditions have attracted considerable attention in recent years (Oliver and Boyd<sup>1</sup>; Gofman *et al.*<sup>2</sup>; Lancet (leading article<sup>3</sup>). According to Anfinsen,<sup>4</sup> lipid complexes, as separated by electrophoresis, are broadly classifiable into chylomicra,  $\alpha$ -lipoprotein and  $\beta$ -lipoprotein. Of the various lipid fractions of human blood serum, main interest has centred round cholesterol and  $\beta$ -lipoprotein, which is reported to contain the major portion of serum total cholesterol. Although chylomicra are reported to contain only small quantities of cholesterol (Bragdon *et al.*<sup>5</sup>), it has recently been observed in this laboratory (Pabrai and Sehra<sup>6</sup>) that considerable proportion of this sterol (rather the Liebermann-Burchard positive substances) is present in chylomicra as well as in an additional lipoprotein complex, namely,  $\gamma$ -lipoprotein.

In the present report, an attempt has been made to show that though  $\beta$ -lipoprotein has a special significance in coronary artery disease, changes in its concentration in serum in megaloblastic anaemia are of interest and may lead to a better understanding of the mechanism(s) controlling this lipoprotein.

MATERIAL AND METHODS

The subjects studied in this investigation include 15 healthy services personnel (Medical Category 'A'; age 25-45 years), 12 proved cases of myocardial infarction (all tests done after

the crisis was over; age 35-55 years) and 10 cases of megaloblastic anaemia (age 20-40 years). Blood was collected fasting and serum was separated within 1 hr. of blood collection. 0.1 ml. of serum was measured out on Whatman No. 1 paper to form a spot 2-3 cm. in diameter which was allowed to dry under a fan to accelerate drying of the serum at room temperature. This was used for estimating of serum total cholesterol. A similar quantity was subjected to horizontal strip electrophoretic separation. Four strips were put up for each sample, one being stained with Sudan Black B solution for lipoproteins, the second with bromophenol blue solution for proteins and the remaining two being used for extraction of cholesterol in different lipid fractions in duplicate. The unstained strips were also examined under ultraviolet light as a confirmatory measure of the localisation of the different lipid fractions. Two fluorescent spots were normally seen—one markedly fluorescent in the region of  $\alpha_1$ -globulin and the other lightly fluorescent almost parallel to the  $\gamma$ -globulin region of the protein-stained strips. Strips of paper were cut to represent different lipoprotein fractions and extraction of cholesterol was completed according to the method of Abell *et al.*,<sup>7</sup> as modified by Anderson and Keys.<sup>8</sup> The colour intensity was measured in the Uvispeck spectrophotometer at 620  $m\mu$ , 25 minutes after the addition of Liebermann-Burchard reagent.

RESULTS

The findings are presented in Table I.

TABLE I

Serum cholesterol content of different lipid components separated by electrophoresis

	No. of cases	Mean cholesterol in mg. % in different fractions					Total of columns 3-6	Total cholesterol experimental mg. %
		$\alpha$ -Lipoprotein	$\beta$ -Lipoprotein	$\gamma$ -Lipoprotein	Chylomicra	Total of columns 3-6		
(1)	(2)	(3)	(4)	(5)	(6)	(7)	(8)	
Normals ..	15	33.0 ± 13.6	56.2 ± 17.0	34.8 ± 14.4	37.2 ± 22.6	153.0 ± 44.0	157.9 ± 45.3	
Myocardial infarction ..	12	27.7 ± 9.4	122.1 ± 28.4	36.4 ± 7.4	34.4 ± 9.4	221.8 ± 41.9	215.5 ± 49.7	
Megaloblastic anaemia ..	10	22.8 ± 8.4	29.6 ± 15.2	32.0 ± 7.5	22.8 ± 12.5	107.2 ± 28.7	108.6 ± 27.9	

The study indicates that, contrary to the observations of Anderson and Keys (*loc. cit.*), the sum total of cholesterol extractable from  $\alpha$ - and  $\beta$ -lipoprotein fractions only is considerably less than that obtained by direct extraction from 0.1 ml. of the serum. It has already been pointed out that this deficiency is made up by cholesterol in  $\gamma$ -lipoprotein and in chylomicra (Pabrai and Sehra, *loc. cit.*).

The table shows that the range of serum total cholesterol in normal Indians obtained by the method of Abell *et al.* (*loc. cit.*) is very much lower than the values obtained by the routine Bloor's method in this laboratory as well as elsewhere (Gopalan and Ramanathan<sup>9</sup>; Padmavati<sup>10</sup>). In our own laboratory, the degree of correlation of the serum cholesterol values obtained by the method of Abell *et al.* to the values obtained by Bloor's extraction method has been found to be 0.8 as compared to 0.836 reported by Anderson and Keys (*loc. cit.*). This difference is most probably due to the smaller number of our cases. In this connection, it may be pointed out that the recalculated values for serum cholesterol by Gopalan and Ramanathan (*loc. cit.*) by application of the above factor ( $r=0.836$ ) are in accord with our observations.

Our observations of total cholesterol and of  $\beta$ -lipoprotein cholesterol in cases of myocardial infarction are in line with the findings recorded in earlier literature (Gofman *et al.*<sup>11</sup>; Lewis and Page<sup>12</sup>; Swahn<sup>13</sup>; Dangerfield and Smith<sup>14</sup>). In a recent publication, Besterman<sup>15</sup> has observed that a specific pre- $\beta$ -lipoprotein band was present in 99% of his 200 cases of ischæmic heart disease and that such a band was absent from sera of normal subjects. Although our technique was essentially similar to the one employed by him, the presence of the pre- $\beta$  band was rather an infrequent feature in the small number of established cases of myocardial infarction studied by us; only 4 of the 12 cases presented here showed a pre- $\beta$  band. Furthermore, a faint pre- $\beta$  band existed in 3 of the 10 megaloblastic anæmia cases also. It is thus obvious that the stress on the pre- $\beta$  band as a specific characteristic of sera of patients suffering from ischæmia heart disease does not appear to be justified.

Megaloblastic anæmia presents an interesting study. While the diminution of total cholesterol in anæmias is an accepted finding, separation of the various fractions of lipoproteins in megaloblastic anæmia shows a probable trend of the mechanisms controlling the levels of  $\beta$ -lipoprotein. This is brought out better in Fig. 1.

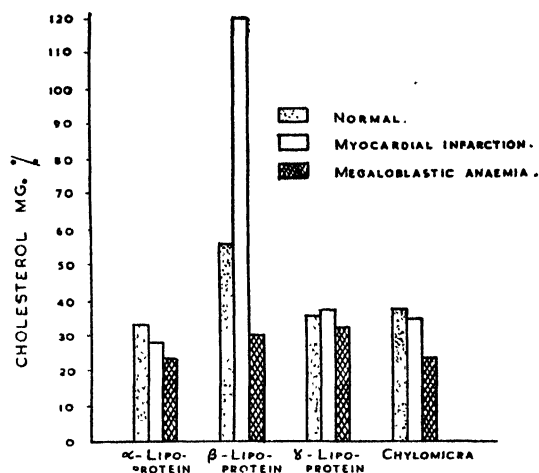

FIG. 1. Distribution of Cholesterol in different Lipid Fractions of Sera.

It is noteworthy that while cholesterol levels in all other fractions are not so markedly affected in myocardial infarction as well as in megaloblastic anæmia, the levels of  $\beta$ -lipoprotein cholesterol are very much elevated in myocardial infarction and markedly depressed in megaloblastic anæmia. The significance of this observation is not understood clearly with the limited data at our disposal. Further work is in progress in this direction.

1. Oliver, M. F. and Boyd, G. S., *Brit. Heart J.*, 1955, **17**, 299.
2. Gofman, J. W., Hanig, M., Jones, H. B., Lauffer, M. A., Lawry, E. Y., Lewis, L. A., Mann, G. V., Moore, F. E., Olmsted, F., Yeager, J. W., Andrus, E. C., Barach, J. H., Beams, J. W., Fertig, J. W., Page, I. H., Shannon, J. A., Stare, F. J. and White, P. D., *Circulation*, 1956, **14**, 691.
3. Leading article, *Lancet*, 1957, **1**, 141.
4. Anfinsen, C. B., Jr., *Fed. Proc.*, 1956, **15**, 894.
5. Bragdon, J. H., Havel, R. J. and Boyle, E., *J. Lab. Clin. Med.*, 1956, **48**, 36.
6. Pabrai, P. R. and Sehra, K. B., *Curr. Sci.*, 1957, **26**, 390.
7. Abell, L. L., Levy, B. B., Brodie, B. B. and Kendall, F. F., *J. Biol. Chem.*, 1952, **195**, 357.
8. Anderson, J. T. and Keys, A., *Clin. Chem.*, 1956, **2**, 145.
9. Gopalan, C. and Ramanathan, K. S., *Ind. J. Med. Res.*, 1957, **45**, 593.
10. Padmavati, S., *Technical Report of Scientific Advisory Board, Indian Council of Medical Research*, 1956, p. 49.
11. Gofman, J. W., Lindgren, F., Elliot, H., Mants, W., Howitt, J., Strisower, B. and Herring, V., *Science*, 1950, **111**, 186.
12. Lewis, L. A. and Page, I. H., *Fed. Proc.*, 1949, **8**, 96.
13. Swahn, B. S., *Scand. J. Clin. Lab. Invest.*, 1953, **5**, Suppl. 9.
14. Dangerfield, W. G. and Smith, E. B., *J. Clin. Path.*, 1955, **8**, 132.
15. Besterman, E. M. M., *Brit. Heart J.*, 1957, **19**, 503.

## VIRUS RESEARCH\*

THE appearance of these two splendid volumes in this series has, I feel certain, fulfilled the expectations of virologists. Indeed, they are to be regarded as *vade mecum* of virus pathologists and physiologists, not to mention the many border-line scientists whose approach to the study of viruses has been biochemical or biophysical. Rich as they are in facts, the highly specialized articles fulfil another purpose: they aim at stimulating new ideas in the specialist and judging from that angle, that keynote has been boldly underlined and admirably executed.

Volume III contains much original material. The chapter on Biochemistry and Virology presents a comparative account on the form and composition of plant viruses, bacterial viruses and animal viruses and critically summarizes available evidences on the fine structure of viral constituents, especially those relating to RNA and DNA contents of virus particles and the amino acid composition of the various strains of plant viruses so far studied. This is followed logically by a chapter on Chemotherapy of Viruses, a subject dealing with the effects of compounds which delay, or inhibit partially, virus multiplication or disease development. As is evident this subject has grown round recent studies on the composition of viruses and the functional mechanism of protein and nucleic acids in virus multiplication and their structure. Many compounds of the purine and pyrimidine analogues have been tried as antagonists and which could, therefore, be incorporated into nucleic acids rendering them biologically non-functional and the possibility of obtaining substantial inhibition of virus multiplication without disorganizing the functioning of the host nucleic acids. The more recent work on metallic ions and chelating agents and the use of antibiotics in relation to virus inhibition is summarized. Work on tumour viruses in bird and mammal is discussed in another chapter and the highlight and emphasis seems to be on the behaviour of the virus of erythromyeloblastic leukaemia which "deviates from the average physical structure of other viruses in its pronounced expression of enzymatic activity and its kinship in antigenic constitution with the host cell in which it originates". It requires no

great imagination to realize "the possible influence of the specific enzyme in the immediate utilization of the stores of energy waiting within the cell for the purposes of virus multiplication and diversion of the metabolic and genetic processes of the host cell".

An authoritative chapter on the morphology and development of insect viruses needs special mention. Electron micrographs have revealed that the polyhedral virus particles are contained within the polyhedral crystals and are crystalline aggregates of the viruses themselves. New and basic thinking in the field of plant virus multiplication in insect vectors is presented and it seems that there is ample evidence for the presence of viruses that multiply both in plants and animals requiring both hosts for their maintenance in nature, a complex situation, indeed, but pregnant with possibilities for further research in this field. The penultimate chapter discusses certain basic questions of natural and acquired immunity, mechanism of cross-protection, interference between viruses largely based on recent observations of yellows type of plant viruses and the concluding chapter deals with bacterial transformations, particularly, discussing the nucleoprotein nature of genes and the autonomy assigned to genes and viruses which appears to be relative. It is argued that DNA has a key role to perform in these determinations of specificity of hereditary characters and that there are subsidiary structures in cells that could influence the specificity of the newly formed DNA and that such a situation for RNA containing viruses like plant viruses has not been clearly demonstrated.

Volume IV in this series with nine chapters seems equally versatile in its presentation of material. The opening chapter on "Factors in Virus Evolution" includes a critical appraisal of the impact of virus evolution on taxonomy and nomenclature\* and discusses the possibility of introducing the Linnæan binomial nomenclature to viruses. This author concludes "we may have to be content for ever to sort viruses into small groups just for our convenience and not to attempt to relate our efforts to phylegeny as plant and animal taxonomists do". Many virus workers may not agree with this view but under existing knowledge there seems no escape from this unhappy position. Bacteriophages as genetic and biochemical systems including problems of protein synthesis and nucleic acid functioning forms the subject-matter of the second chapter. Attachment and

\* *Advances in Virus Research*. Vols. III and IV. Edited by K. M. Smith and M. A. Lauffer. (The Academic Press, New York, India: Asia Publishing House, Bombay-1.) Pp. ix + 338; ix + 339. Price \$ 7.00 each.

penetration by viruses as a fundamental question and the physical, chemical, immunological, anatomical and genetic approach to a study of this problem and another chapter on measuring concentration of animal viruses involving methods of calculation from mass, volume and density of virus particles are of absorbing technical interest. A detailed consideration of the anatomy of tobacco mosaic virus getting together a large assemblage of evidences on the particle size, surface features, internal structures, etc., make very interesting reading. Other chapters that follow contain information on effects of non-ionizing radiations on viruses, effects of changing temperature on plant virus diseases, mechanical transmissions of plant viruses. The final chapter is on the nature of serological relationships among influenza viruses. From the practical point of view, the chapter on heat therapy and *in vivo* inactivation of certain plant viruses would be read with considerable interest by plant pathologists

in this country as many vegetatively propagated clones can be subjected to this therapy and it is to be hoped that some headway would be made in this simple yet practicable control measure.

The reviewer has had the pleasure of warmly commending the earlier volumes in this series and the present review of Volumes III and IV should convince everyone, more than ever, of the enormous part these publications play in stimulating original thinking in a difficult field of research with ultramicroscopic pathogens. There are, here and there, signs of slackness in proof-reading in these volumes but this is outbalanced by a fine get-up and rich scientific matter. One fondly hopes that in the not distant future India would have an Institute for Microbiology with strong arms of virus research in plant, insect, animal and human viruses as it is obvious we have to make much headway in this field of science.

T. S. SADASIVAN.

---

#### USSR ACADEMY OF SCIENCES DISCUSS DATA FROM SPUTNIKS EXPERIMENT WITH A DOG

**T**HE dog "Laika" the first animal to travel into space aboard the second Soviet Sputnik stood satisfactorily not only the launching and the orbiting of the Sputnik but also the orbital flight itself.

This statement was made by Academician Aleksandr Topchiev, Chief Scientific Secretary of the Presidium of the USSR Academy of Sciences. He said that the checking of the possibility of survival of an organism in cosmic flight was a unique experiment which has provided valuable data.

Preliminary results of the study of "Laika's" behaviour show that the acceleration of the Sputnik's flight at its launching and orbiting—which is the most difficult stage from the biological standpoint—had acted on the animal in the direction from its chest to its back. He recalled that the movement of the Sputnik was accelerated and that the rate of acceleration was several times higher than the acceleration of gravity. It has been established that simultaneously with the effect of the acceleration the animal was also affected by the vibration and for a certain period by the sound of the rocket engine.

An analysis of the data has shown that imme-

diately after the start the heart action quickened roughly three-fold as compared with its initial state. Later on, as the effect of the acceleration persisted and even increased, the frequency of the heart action fell. The electrocardiogram did not reveal any ill-effects. It showed a typical picture of thickened heartbeats, the so-called Sinus Tachycardia.

As the apparent weight of the animal increased, its respiration became more superficial and accelerated. At the height of the effect of the acceleration, the number of respirations was 3 to 4 times higher than initially.

Academician Topchiev declared that the animal had satisfactorily stood the flight of the Sputnik from start to orbiting. During the subsequent flight in orbit the animal was in a state of dynamic imponderability. The number of respirations declined, the frequency of the systole continued to fall systematically and to approach the initial magnitude. In spite of the unusual state of imponderability the motorial activity of the animal was moderate.

The experiment with "Laika" has demonstrated that imponderability did not in itself cause any substantial or enduring changes in the animal's physiological functions.

---

## LETTERS TO THE EDITOR

GROWTH SPIRALS ON ELECTRO-  
DEPOSITED SILVER

THE concepts of the edge dislocation<sup>1</sup> and the screw dislocation<sup>2</sup> were originally proposed on purely theoretical grounds to account for the mechanical properties of real metal crystals. A considerable experimental evidence exists now in support of the application of the concept of the screw dislocation to account for the growth of real crystals from low degrees of supersaturation.<sup>3,4</sup> Growth spirals on crystals of hexagonal metals and also of silver (grown from vapour) were observed by Forty<sup>5</sup> and by Frank and Forty.<sup>6</sup>

During the study of the dendritic growth of metal crystals initiated by chemical replacement and also by electrolysis, interesting results were obtained in the case of silver. The crystals of silver were grown by electrolyzing



Showing a Triangular Spiral,  $\times 800$ .

an aqueous solution of  $\text{AgNO}_3$  in a specially designed electrolytic cell. The crystals thus grown were essentially cubo-octahedra and it is on the 111 faces that several interesting features were observed. In some cases, these faces were plane to the atomic scale, whereas in certain other cases, growth spirals (triangular, hexagonal and circular) were observed. Fig. 1 is one such typical case. So far no attempts have been made to measure the step heights of the spirals. Some spirals appear to be very flat and can be observed with great difficulty, whereas in a few cases, the spirals could be seen clearly even under an ordinary

microscope. These observations suggest that the Burgers vector of the screw dislocation responsible for the growth spiral is not necessarily limited to a unit lattice displacement as is generally assumed. Further work on the interaction of the slip lines (caused by the movement of the dislocations) and the growth steps is in progress. It may finally be mentioned that the spirals could be made more distinct by 'decoration' as described by Frank and Forty.<sup>6</sup>

Dept. of Physics,  
College of Science,  
Nagpur, January 6, 1958.

V. G. BHIDE.  
W. G. NAFDE.

1. Tayler, G. I., *Proc. Roy. Soc.*, 1934, **145 A**, 362.
2. Burgers, J. M., *Proc. Kon. Ned. Acad. Wet.*, 1939, **42**, 293.
3. Frank, F. C., *Disc. Far. Soc.* (Crystal Growth), 1949, **5**, 49.
4. —, *Phil. Mag. Supplement*, 1952, **1** (1).
5. Forty, A. S., *Phil. Mag.*, 1952, **43**, 949.
6. Frank, F. C. and Forty, A. J., *Proc. Roy. Soc.*, 1953, **217 A**, 262.

THE REDUCTION OF THORIUM  
AT THE DROPPING MERCURY  
ELECTRODE

THORIUM (IV) is known to give only a catalytic wave at  $-1.0\text{ V vs. S.C.E.}$  in  $0.1\text{ M KCl}$  in the presence of excess nitrate.<sup>1</sup> Since lower valence states, though of low stability have been reported,<sup>2</sup> a more detailed study has been undertaken. In  $0.1\text{ M LiCl}$ , it has been observed that thorium chloride shows two waves, one at  $-1.6\text{ V}$  and the other at  $-1.78\text{ V vs. S.C.E.}$  respectively. The first of these appears as a continuation of the hydrogen wave, the wave height rising both with fall in pH and increase in thorium concentration. The height of the second wave at  $-1.78\text{ V}$  is only dependant on thorium concentration.

On a Cambridge photographic recording polarograph with a capillary of characteristics  $m\ddot{t}t = 1.649\text{ mg.} \cdot \ddot{t} \text{ sec.}^{-1}$ , in  $0.1\text{ M LiCl}$  in the presence of  $0.01\%$  gelatin as suppressor, and drop rate  $16$  per minute at  $28.0^\circ\text{ C.} \pm 0.5^\circ\text{ C.}$  the following results have been obtained.

When the concentration of thorium is maintained constant at  $6.48\text{ M}^{-3}$ , in the first wave ( $E_{a_1} = -1.67\text{ V}$ ), the diffusion current lies between  $21$  and  $22\ \mu\text{A}$ , in the pH interval  $3.42$

to 2.00, when allowance is made for the hydrogen wave. In this interval the height of the latter rises from 2.0 to 90.0  $\mu$ A. Secondly at pH 3.3, the two waves ( $E_{a_1} = -1.67$  V and  $E_{b_1} = -1.78$  V) show a linear rise with concentration of thorium in the range 3.0-12.0 M<sup>-3</sup>; the average increase in wave height being 3.26 and 1.44  $\mu$ A per millimole respectively. The extreme values lie between 3.21 and 3.36  $\mu$ A in the first case and 1.36 and 1.54  $\mu$ A in the second case.

These two sets of data leave no doubt that a true reduction process is involved in both cases. The actual reduction mechanism is difficult to state at this stage. It may not be a consecutive reduction as  $Th^{4+} \rightarrow Th^{2+} \rightarrow Th^0$ , since the height of the second wave is only a fraction of that of the first wave.

Further work is in progress.

Inorganic Chemistry T. P. SARMA.

Labs., BH. S. V. RAGHAVA RAO.  
Andhra University,  
Waltair, November 25, 1957.

1. Patterson, J. H. and Banks, C. V., *Anal. Chem.*, 1948, 20, 897.
2. Hayek, E. and Reyner, Th., *Experientia*, 1949, 5, 114 (*C.A.*, 43, 8932); Anderson, J. S. and D'eye, R. W. M., *J. Chem. Soc.*, 1949 (Suppl. issue No. 2, 244).

### CHEMICAL EXAMINATION OF ARISTOLOCHIA BRACTEATA RETZ.

WHILE we were engaged on a study of the extract from *Aristolochia bracteata* Retz. (Aristolochiaceæ), which was locally regarded as a powerful anthelmintic,<sup>1</sup> Pailer, Belohlov and Simonitsch<sup>2</sup> published two papers in which aristolochic acid, a common constituent of several species of Aristolochiaceæ, was shown to be a rare compound derived from 9-nitrophenanthrene. Coutts, Stenlake and Williams<sup>3</sup> also confirmed this constitution of aristolochic acid.

From the ether-soluble fraction of the alcoholic extract of the fresh roots (1.5 Kg.), aqueous bicarbonate furnished two yellow acidic compounds. The first (yield: 0.1%) crystallised as bright yellow needles from alcohol: m.p., 275-77° C. (decomp.). (Found: C, 59.9, H, 3.9; N, 3.6;  $CH_3O$ , 9.0;  $C_{17}H_{11}O_7N$  requires C, 59.8; H, 3.2; N, 4.1;  $1-CH_3O$ , 9.1%) U.V. absorption data, measured on Hilger Uvispek photoelectric spectrophotometer:  $\lambda_{max}$ , 392,  $\log \epsilon$ , 3.81;  $\lambda_{max}$ , 320,  $\log \epsilon$ , 4.11;  $\lambda_{max}$ , 250,  $\log \epsilon$ , 4.48;  $\lambda_{max}$ , 228,  $\log \epsilon$ , 4.50. In butanol-acetic acid-water (25:0.1:25), it has  $R_f = 0.92$ .

Methyl ester (diazomethane) melted at 278-80° C. (Found: C, 60.8; H, 4.0;  $OCH_3$ , 17.9;  $C_{18}H_{13}O_7N$  requires C, 60.9; H, 3.7;  $2-OCH_3$ , 17.5%.)

Decarboxylation (copper bronze-quinoline) yielded a nitro hydrocarbon (orange needles, m.p., 204-05° C.) identical with 1-methoxy-9-nitro-5:6-methylenedioxy phenanthrene,<sup>2,3</sup> (Found: C, 64.7; H, 4.0; N, 4.5;  $OCH_3$ , 10.1;  $C_{16}H_{11}O_2N$  requires C, 64.7; H, 3.7; N, 4.7;  $1-OCH_3$ , 10.4%.)

From the above the yellow acidic compound is regarded as identical with aristolochic acid.<sup>2,3</sup>

The second compound crystallised from alcohol as orange yellow needles melting indefinitely between 240-52° C., yield: 26 mg.

The seeds (600 g.) from the capsules of *A. bracteata* Retz. were also examined. Extraction with petroleum ether furnished a greenish brown non-drying oil (Sp. gr. 0.908; Sap. value, 195; Iodine value, 82). Yield: 6%. The defatted seeds, on extraction with acetone furnished a reddish yellow crystalline solid which could be separated into aristolochic acid (55 mg.) and the orange compound (18 mg.) by fractional crystallisation from alcohol.

Dept. of Chemistry, K. V. JAGANNADHA RAO.  
Andhra University, L. RAMACHANDRA ROW.  
Waltair, Y. SURYANARAYANA MURTY.  
December 25, 1957.

1. Kirtikar, K. R. and Basu B. D., *Indian Medicinal Plants*, 3, 2117.
2. Pailer, M., Belohlov, L. and Simonitsch, E., *Monat. Chem.*, 1956, 87, 17 and 1957, 88, 367.
3. Coutts, R. T., Stenlake, R. T. and William, W. D., *J. Chem. Soc.*, 1957, 4120.

### PETROLOGICAL INVESTIGATIONS OF THE ROCKS OF MOHAND NEAR DEHRA DUN

THE Siwalik rocks exposed along the Mohand Bridge-Kherirau-Bongsot section of Mohand lie between (Long. 77° 55' 30" and 77° 55' 15" and Lat. 30° 12' 30" and 30° 12'). Detailed literature on these rocks is lacking. With a view to study the nature of these rocks and to compare them to the other known Siwalik rocks of Punjab, samples were collected along the dip traverse at stratigraphic intervals of 100', 200', 300' excepting at places where there were lithological variations, over a vertical thickness of 3,650'.

The rocks exposed are mostly sandstones, clays and conglomerates. The sandstones vary from coarse-grained to fine-grained varieties.

The clays are mostly brown, maroon-coloured varieties. Conglomerates are composed of pebbles of quartzite, opal, jasper and clay nodules cemented by calcite in the matrix. At some places the pebbles in the conglomerates show crude orientation.

#### LABORATORY INVESTIGATIONS

Twenty-five samples of sandstones and 9 samples of clays were treated for petrological studies. The heavy minerals were treated along the lines suggested by Groves.<sup>1</sup> Clays were studied by a simple colouration method given by Vedeneva and Vikulova<sup>2</sup> and demonstrated by Prof. Tatarsky, Consulting Specialist to the Oil and Natural Gas Commission. Light crop and carbonate minerals were studied by immersion method given by Tatarsky.<sup>3</sup> Mechanical analyses of sandstones were done by the method described by Tatarsky.<sup>4</sup>

The heavy minerals that constitute the assemblage in order of abundance are opaques, garnet, kyanite, hornblende, zoisite, tourmaline, staurolite, rutile, chlorite and zircon of which garnet, hornblende and kyanite form the bulk of the assemblage and the rest are accessory in character. We notice a sympathetic variation of rutile with zircon and colourless garnet with the coloured one. The nature of the assemblage suggests metamorphic and granitic rocks as the probable source rocks for these sediments.

The light crop constitutes the assemblage of quartz, feldspar, rock-fragments and weathered fragments. Quartz occurs in subangular to subrounded grains. The grains are generally colourless but hazy in many cases. Some of the grains show strain effects like undulose extinction. They are full of microscopic inclusions which are irregularly distributed throughout the grains. Under high power objective the inclusions show a rounded or elliptical outline with a faint border. Some of the inclusions appear to be liquid and gas inclusions. There are also mineral inclusions of magnetite, zircon, rutile and biotite in some of the quartz grains. Most of the inclusions are of indeterminate character. Feldspar is present in subordinate amounts. It is remarkably fresh and is mostly orthoclase, untwinned. Some of the feldspars are microcline and albite. The rock fragments comprise of mostly quartzite, quartz-feldspar aggregate and quartz-sericite-schist. The nature and study of light crop indicate the source to be metamorphic and granitic rocks, and the source to be near.

Clays were studied by the colouration method and the studies indicate the clays to be mostly of illite composition with various stages of hydrolysis. The uniform composition of clays indicates that the condition of deposition was almost uniform.

Carbonate mineral studies indicate that the nature of carbonate material constituting the cement in sandstones, is mostly calcite excepting at the upper part of the section where it is calcite and dolomite. All the sandstones are mostly calcareous and the carbonate content present in them varies from 9% to 37%.

The study of mechanical analyses indicates that the sandstones vary in grain size from coarse-grained to fine-grained falling between coarse-grained sandstone to fine-grained silty sandstones. The sorting is medium but at the bottom of the section the sorting is good. This feature lends support that most of the sediments constituting these rocks were not transported over a long distance.

The entire section comprising a thickness of 3,650' along Kherirau and Bongso nalla section could be conveniently divided into three horizons on the basis of the results of the heavy minerals, light crop and clay studies and is shown in Fig. 1.

(1) Samples from 2727-2737 are characterised by absence of green variety of tourmaline and presence of yellow variety of tourmaline.

(2) Samples from 2737-2748 characterised by the presence of hornblende and green tourmaline.

(3) Samples from 2748-2751 characterised by the absence of hornblende.

These boundaries coincide with the boundaries marked by the study of clays. From the study of clays three zones could be conveniently marked along the section.

(1) Samples 2748-2751 marked by illite composition.

(2) Samples 2747-2748 marked by hydrolysed illite.

(3) Samples 2736-2747 marked by illite of varying stages of hydrolysis.

This boundary lies 50' below the boundary marked by mineral studies.

From the light crop studies, the boundary could be drawn at (1) sample 2735 characterised by quartz-feldspar ratio and hazy quartz border, (2) at sample 2738 characterised by clear quartz border, and (3) at sample 2735 characterised by quartz-sericite-schist and quartz with inclusions of indeterminate character border. All these borders are 100' above or below the border marked by heavy mineral,



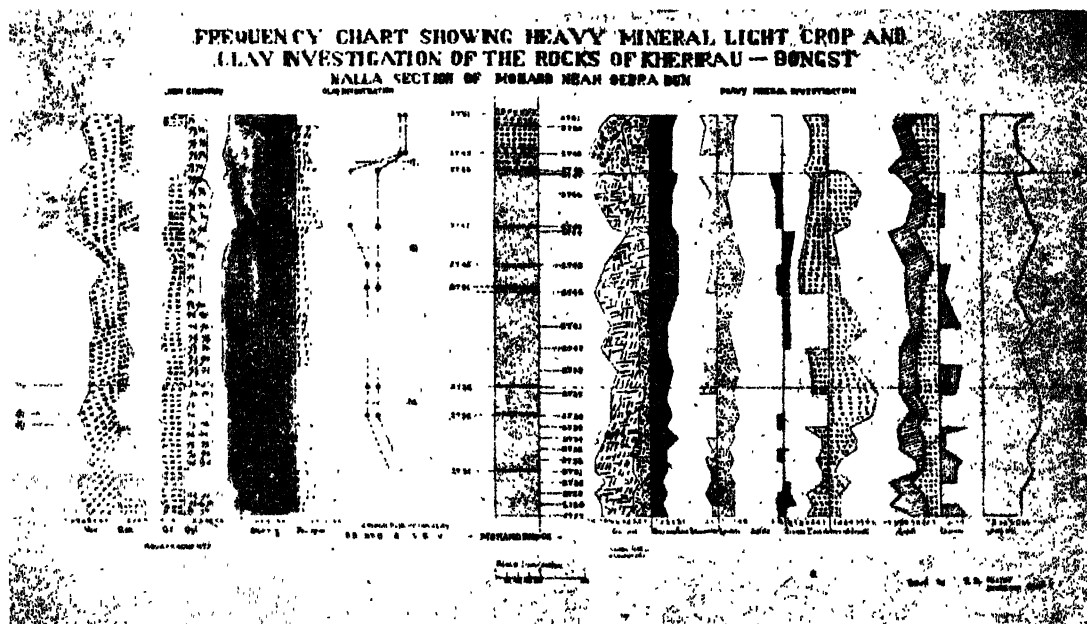

FIG. 1.

and clay border denotes changes in source rocks. The fluctuation and oscillation of the boundary as marked by light mineral studies indicate that the change in conditions of environment was gradual at that period.

From the studies instituted on the rocks of Janaury area (Punjab) the authors notice a very close resemblance and similarity in the heavy mineral assemblage of Mohand and Janaury, though they are separated over a distance of 250 miles. This clearly points to the fact that the source rocks which gave rise to these sediments were the same and the conditions of depositional environment were similar. Further the above studies point that these sediments were not transported over long distance and the source to be near. The deformed nature of kyanite and the strain effects shown by some of the quartz indicate to a highly disturbed source.

It is, therefore, hypothetically suggested that the source rocks which gave rise to these sediments belong to one continuous mountain chain.

The authors express their thanks to Prof. V. B. Tatarsky, Consulting Petrologist to the Oil and Natural Gas Commission, for his valuable guidance and suggestions, and to Dr. A. K. Dey, Director of Geology, Oil and Natural Gas Commission, for the kind permission to publish this paper.<sup>5</sup>

Petrological Labs.,  
Oil and Natural Gas  
Commission,  
Dehra Dun, December 30, 1957.

S. K. BABU.  
P. V. DEHADRAI.

1. Groves, A. W., "Heavy minerals of plutonic rocks of Channel Islands, I," *Geol. Mag.*, 1927, 64.
2. Vedeneeva, N. E. and Vikulova, M. F., *Methods of Investigation of Clay Minerals with the Help of Dyes and Its Application to Lithology*, State Publ. House of Geol. Literature, 1952.\*
3. Tatarsky, V. B., *Microscopic Determination of Carbonate Minerals*, Leningrad State Sci. & Tech. Publishing House of Oil and Fuel Literature, 1955.\*
4. — and Ivanova, I. I., Article on mechanical analysis in the book *Method of Analysis of Raw Minerals*, State Sci. & Tech. Publishing House, 1936.\*
5. Babu, S. K. and Dehadrai, P. V., "Petrological Investigations of the Rocks of Mohand near Dehra Dun," *Abstract Ind. Sci. Cong. Assn.*, 1958, Part III, 238.

\* Original in Russian language.

#### γ-SUBSTITUTION IN RESORCINOL DIMETHYL ETHER

GRIEHL<sup>1</sup> has described a novel method of preparation of arylacetic acids by the action of potassium permanganate on aromatic substances in boiling acetic anhydride. By application of this procedure to resorcinol dimethyl ether we have obtained an acid, m.p., 152-53° C. (Found : C, 61.0; H, 5.9. Equivalent weight, 194.2. Cal-

culated for  $C_{10}H_{12}O_4$ : C, 61.2; H, 6.1%. Equivalent weight, 196.) The acid formed an amide, m.p. 157° C. (Found: N, 7.0. Calculated for  $C_{10}H_{13}O_3N$ : N, 7.2%.) The product of oxidation is therefore 2:6-dimethoxyphenylacetic acid<sup>2,3</sup> and represents a novel case of  $\gamma$ -substitution in the resorcinol nucleus.

SHRIMATI H. R. JAYAMMA.

A. R. INAMDAR.

Dept. of Chemistry, K. S. NARGUND.  
Karnatak University,  
Dharwar, February 14, 1958.

1. Griehl, *Ber.*, 1947, **80**, 410.
2. Shepard, Porter, Noth and Simmans, *J. Org. Chem.*, 1952, **17**, 571.
3. King and Grundon, *J. Chem. Soc.*, 1950, 3547.

### CELLULOSE DECOMPOSITION BY SPECIES OF *NOCARDIA*

QUITE recently Metcalfe and Brown<sup>7</sup> isolated from soil a species of *Nocardia* possessing the ability to decompose cellulose and they gave a valuable determinative description of it and named it as *Nocardia cellulans* apparently assuming that the power of cellulose decomposition had not previously been reported for the genus *Nocardia*. The object of the present communication is to point out that, although detailed descriptions of the *Nocardias* associated with cellulose decomposition had not previously been given, cellulolytic activity had been attributed to the genus before.<sup>3-5</sup> A detailed description of the unnamed *Nocardia* species isolated from marine sources some six years ago is also included in this paper (Table I) with a view to emphasising the cellulolytic power shared by the genus *Nocardia*. No attempts will here be made to describe the five species isolated anaerobically (the organism being capable of growing aerobically) from cellulose enrichments set up with the intestinal tract of the Indian earthworm and briefly reported upon by Khambata and Bhat.<sup>6</sup>

The cellulose enrichments made with the intestinal contents of the earthworm yielded 39 bacteria and 49 actinomycetes.<sup>6</sup> Of the 49 latter isolates, 28 belonged to the genus *Nocardia* and the rest proved to be cellulose utilising *Streptomyces*. A comprehensive account of all the isolates had been presented in theses before.<sup>5</sup> Of the 28 *Nocardias*, 23 were identified as *N. corallina* despite certain differences in characters as detailed for the species in the *Bergey's Manual*.<sup>1</sup> The remaining 5, isolated

from anaerobic enrichments (but capable of aerobic existence) were only cursorily referred to and remain to be fully reported though they had been described in the theses.<sup>5</sup> However, a brief account of these isolates including the observation on the close association of *Mycobacterium agreste* (synonymous with *N. corallina*) with digestion of cellulose<sup>11</sup> had appeared elsewhere.<sup>6</sup>

Similarly the *Nocardias* and other actinomycetes obtained from cellulose enrichments made with materials derived from marine sources had been the subject of another study.<sup>3</sup> Freitas<sup>3</sup> studied in detail three of the several *Nocardias* isolated by her from deteriorating fish-nets and cordage and of these one could be referred to as *N. corallina*. However, all the three were carefully examined with respect to their nitrogen and carbon requirements as well as from the point of view of their halotolerance, and were indeed shown to be halophilic in nature and capable of utilising cellobiose, dextrin, starch, cellulose and agar in addition to palmitate and stearate, the substrates being those commonly employed in the tests for cellulolytic activity.<sup>4</sup> It may be of interest in this connection that the authors had emphasised the role of *Nocardia* (and other *Actinomycetes*) in the decomposition of fish-nets and cordage and considered this organism as "one of the important cellulose decomposing *Actinomycetes*".<sup>4</sup>

Thus far over 50 *Nocardias* (derived from soil, earthworm intestine, coconut oil<sup>12</sup> and marine sources) have been studied in detail in this laboratory and a great majority of them have been referred to as *N. corallina* and *N. rubra* as it is both desirable and convenient to avoid, save under exceptional cases, creation of new species but to refer them to the nearest species listed in the *Bergey's Manual*. Accordingly, a detailed account of the morphological and other peculiarities of the *Nocardia* had appeared elsewhere.<sup>13</sup>

TABLE I

Description of the marine species isolated from cellulose enrichments

*Morphology and Gram reaction on nutrient agar*: Gram positive filaments with a tendency to branching to short-branched rods; fragment to short rods and coccoidal forms within 2 to 3 days. Not acid-fast.

*Growth on nutrient agar*: Cheese-like smooth, slightly convex, orange or pink colonies with a filamentous margin; colour agrees with either Capucine orange (Ridgway,<sup>9</sup> Plate III, 13, OY-od) or Grenadine (Plate II, 7, R-ob).

**Growth on cellulose agar:** As on nutrient agar or as pink cheese-like colonies with a spreading margin.

**Nutrient broth:** Heavy turbidity with either slimy or flocculent sediment; scum-like growth along sides of tube.

**Growth on potato:** Heavy, either Ochraceous orange (Plate XV, 15'-y-o-b) or Grenadine (Plate II, 7, R-ob).

**Growth on cellulose media:** (a) *Omeliansky's solution*<sup>1</sup>: Turbidity; filter-paper coloured orange. (b) *Dubos' solution*<sup>2</sup>: Heavy turbidity and sediment; paper light pink. (c) *Peptone sea-water*<sup>3</sup>: Profuse growth, turning paper orange or deep pink. (d) *China-blue-auri-cellulose agar*<sup>10</sup>: Growth.

**Indole:** Not formed.

**Hydrogen sulphide:** Formed in traces to give a faintly positive reaction.

**Nitrate peptone water:** Nitrate reduced to nitrite, but not ammonia.

**M.R. and V.P. tests:** Negative.

**Litmus milk:** Alkalinity and slight reduction of litmus.

**Hydrolysis of starch, gelatin and casein:** Negative.

**Catalase:** Positive.

**Sugar media:** Acid in glucose and mannite, but not in lactose, sucrose, maltose, dextrin, starch and glycerol.

**Paraffin utilisation:** paraffin utilised; but not phenol, cresol or benzene.

Microbiology Dept., YVONNE M. FREITAS.  
St. Xavier's College, J. V. BHAT.  
Bombay, February 21, 1958.

\* Present address: Fermentation Technology Laboratory, Indian Institute of Science, Bangalore.

1. Breed, R. S., Murray, E. G. D. and Hitchens, A. P., *Bergey's Manual of Determinative Bacteriology*, 1948, 6th ed., Williams & Wilkins, Baltimore, Md.
2. Dubos, R. J., *J. Bacteriol.*, 1928, **15**, 223.
3. Freitas, Y. M., *M.Sc. Thesis*, 1953, Univ. Bombay.
4. Freitas, Y. M. and Bhat, J. V., *J. Univ. Bombay*, 1954, **23**, Part 3 B, 53.
5. Khambata, S. R., *M.Sc. Thesis*, 1952; *Ph.D. Thesis*, 1954, Univ. Bombay.
6. — and Bhat, J. V., *Archiv für Mikrobiologie*, 1957, **26**, 69.
7. Metcalfe, G. and Brown, M. E., *J. gen. Microbiol.*, 1957, **17**, 567.
8. Omeliansky, W., *Centralt. Bakt.*, 1902, II Abt., **8**, 226.
9. Ridgway's *Color Standards and Color Nomenclature*, 1912, Washington, D.C.
10. Sanborn, J. R., *J. Bacteriol.*, 1926, **12**, 343; 1927, **14**, 395.
11. Shrikhande, J. G., *Biochem. J.*, 1933, **27**, 1563.
12. Vakil, J. R. and Bhat, J. V., Abstract of Papers, *Symposium on Lipids*, 1958, Soc. Biol. Chemists, India, 16.
13. —, Khambata, S. R. and Bhat, J. V., *Proc. Ind. Acad. Sci.*, 1952, **36B**, 243.

## STUDIES ON THE STRUCTURE AND PHYSIOLOGY OF THE FLIGHT MUSCLES OF BIRDS

### 3. Alkaline Phosphatase Activity in the Pigeon Breast Muscle

It has been shown by George and Jyoti<sup>1</sup> and later on by George and Naik<sup>2</sup> that the *pectoralis major* muscle of the pigeon contains two types of fibres, a broad white variety loaded with glycogen and a narrow red variety which contains comparatively little glycogen but large quantities of fat. George and Scaria<sup>3</sup> have shown that this muscle contains a high concentration of lipase and a histochemical study of the lipase activity revealed that the enzyme is confined to the narrow fibres.<sup>4</sup> A similar observation was made in the *pectoralis major* muscle of the bat.<sup>5</sup> Here we report the result of a histochemical study undertaken to demonstrate the localization of alkaline phosphatase in the *pectoralis major* muscle of the pigeon.

The alkaline phosphatase activity was studied on transverse sections of the frozen tissue cut according to the method of George and Scaria.<sup>4</sup> The sections were transferred to clean slides and allowed to dry at room temperature (about 1 hour). They were then fixed in 10% cold (4° C.) formalin for 2 hours,<sup>6</sup> washed in running water for 30 minutes and used for the study after rinsing in distilled-water. The method employed was the revised method of Gomori using sodium glycerophosphate as substrate.<sup>6</sup> The sections were incubated in the substrate medium at 40° C. for 24 hours, treated with cobalt nitrate and ammonium sulphide and mounted in glycerine jelly without counterstaining. Two controls were tried; in one the incubation of the sections in the substrate medium was omitted and in the other the sections were incubated after keeping them in boiling water for 10 minutes.

From previous experience it was found that the pigeon kidney showed very high alkaline phosphatase activity after half-an-hour of incubation, but in the case of the muscle, satisfactory results could be obtained only on prolonged incubation (24 hours). Fig. 1 presents the photomicrograph of a transverse section of the *pectoralis major* muscle of the pigeon showing localization of the enzyme activity. It is clearly seen that the nuclei are deeply stained indicating high phosphatase activity. Of the two types of fibres, the cytoplasm of the narrow fibre shows a higher activity of the enzyme. In the broad fibre on the other hand, the cell border is stained and that too faintly, suggest-

ing that the enzyme is located mainly if not solely in about the sarcolemma. It would appear that most of the transphosphorylation reactions take place in the narrow fibres and the presence of the enzyme at the border of the glycogen-loaded broad fibre is to aid in the transport

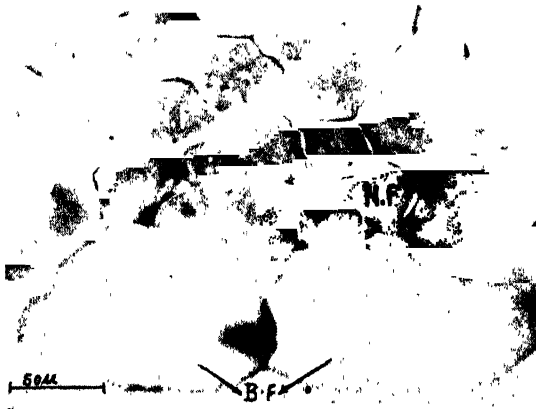

FIG. 1. Microphotograph of a transverse section of the *pectoralis major* muscle of pigeon showing localization of alkaline phosphatase activity. (B.F., Broad Fibre; N.F., Narrow Fibre.)

of glycogen from the broad fibres to the narrow fibres. It should be of interest to note here that the enzymes of the Krebs' cycle are confined only to the narrow fibres.<sup>7</sup> A similar condition may be expected in the case of the *pectoralis major* muscle of the bat and other animals in which there are two such distinct types of fibres. This study is now in progress in our laboratories.

Histochemical Lab., J. C. GEORGE.  
Dept. of Zoology, S. MADHAVAN NAIR.  
M. S. University of Baroda, K. S. SCARIA.  
Baroda, February 1, 1958.

1. George, J. C. and Jyoti, D., *J. Anim. Morph. Physiol.*, 1955, 2, 1.
2. — and Naik, R. M., *Nature*, 1958, 181, 709.
3. — and Scaria, K. S., *J. Anim. Morph. Physiol.*, 1956, 3, 2.
4. —, *Nature*, 1958, 181, 783.
5. —, Sushila, A. K. and Scaria, K. S., *Naturwissenschaften*, 1958, 45, 93.
6. Pearse, Everson, A. G., *Histochemistry, Theoretical and Applied* (J. and A. Churchill, London, 1954).
7. George, J. C. and Scaria, K. S., Under preparation.

#### THE SUBCOMMISSURAL ORGAN IN THE GARDEN LIZARD *CALOTES VERSICOLOR*

THE subcommissural organ as a possible secretory centre has been investigated in certain rodents by Wislocki and Leduc<sup>1,2</sup> and in certain carnivores by Bargmann and Schiebler.<sup>3</sup>

These workers concluded that the subcommissural organ is a site of secretory activity and that the products of secretion are released into the third ventricle directly, or indirectly through the agency of the Reissner's fibre. As a result of studies involving electrocoagulative ablation and injection of extracts of the subcommissural organ in the rat, Gilbert<sup>4</sup> concluded that the subcommissural organ has an important endocrine function in water metabolism.

The following is a preliminary report of studies of the morphology and function of the subcommissural organ in the garden lizard.

Brains of garden lizards were fixed in Bouin's fluid, embedded in paraffin, sectioned at 6-7 micra thickness and stained by Gomori's chrome alum-haematoxylin phloxin method and Foot's modification of Masson's trichrome.

The subcommissural organ is situated in the roof of the third ventricle in very close ventral relationship to the commissura pallii posterior. It consists of modified ependymal cells lining the roof of the third ventricle. From its caudal end fibrils arise and unite to form a delicate strand known as the Reissner's fibre, which passes into the lumen of the aqueduct (Fig. 1). The cells of the subcommissural organ



FIG. 1. Photomicrograph of a sagittal section through the subcommissural organ stained by Gomori's method,  $\times 50$ . (V III denotes the third ventricle, and Rf denotes the Reissner's fibre.)

are of tall ciliated columnar type, with indefinite cell boundaries. The nuclei are situated at various levels close to the basal aspects of the cells, giving the whole epithelium a pseudostratified appearance. The nuclei are of moderate size, vesicular, and show distinct nucleoli and chromatin network. Aggregations of blue-black granules are abundant around the nuclei and the basal parts of the cells. The granules

become discrete and powdery towards the ciliated ends. The cilia are not numerous and are covered by a precipitate, and often show distinct granules embedded in them. From the basal parts of the cells, processes arise, group themselves into thin bundles, and traverse the posterior commissure at the periphery of which the fibres again separate out in a fan-like manner to end in close relationship to the subpial blood vessels (Figs. 2 and 3). These processes



FIG. 2. Photomicrograph of a sagittal section through the posterior commissure and the subcommissural organ, stained by Foot's modification of Masson's trichrome,  $\times 225$ . (PC denotes the posterior commissure; the arrows point to the secretory material passing along the basal processes of the cells of the subcommissural organ.)



FIG. 3. Photomicrograph of a sagittal section through the posterior commissure and the subcommissural organ stained by Foot's modification of Masson's trichrome,  $\times 225$ . Note the fan-like ending of the basal processes in relation to the peripheral blood vessel (Bl. v.).

are similar to those found in the cuboidal cells of the general ependyma, with the difference

that the former carry Gomori-positive material along them. This material can be traced to greater or lesser extents along the processes and in some cases accumulations of the material are seen in the distal ends of the processes in the form of small droplets. In the posterior commissure the nuclei of glial cells took up the chrome-haematoxylin stain. But these cells contained no Gomori-positive granules in their cytoplasm.

Thus, while in general features the reptilian subcommissural organ resembles that of the mammal, two important differences exist between the two. Firstly, there is a paucity of the reactive glial cells in the posterior commissure of the reptile. Secondly, the basal processes carrying Gomori-positive material towards the peripheral blood vessels are peculiar to the reptilian subcommissural organ and have not been described in any mammal. Thus the pattern of distribution of the Gomori-positive material in the cells and their processes of the subcommissural organ of *Calotes versicolor* seems to indicate that here, as in the supra-optico-hypophyseal system of this animal,<sup>5</sup> there is a double route available for the discharge of the products of secretion.

Dept. of Anatomy, K. R. PANDALAI,  
Medical College,  
Trivandrum, February 19, 1958.

1. Wislocki, G. B. and Leduc, E. H., *J. Comp. Neur.*, 1952, **97**, 515.
2. —, *Ibid.*, 1954, **101**, 283.
3. Bargmann, W. and Schiebler, T. H., *Zeitsch. f. Zellforsch.*, 1952, **37**, 582.
4. Gilbert, G. J., *Anat. Rec.*, 1956, **126**, 253.
5. Pandalai, K. R., *Curr. Sci.*, 1956, **25**, 368.

### NUCLEAR DIFFERENTIATION IN BINUCLEATE POLLEN MOTHER CELLS

THE writer<sup>1</sup> has described evidence which leads to the conclusion that the capacities for nucleolar and DNA synthesis in a chromosome may be correlated. The evidence was based mainly on the observation that in *Lolium* the DNA-conditioned development of one or more of the chromosomes in a nucleus may be retarded experimentally and when this is done, the affected chromosomes also fail to take part in the synthesis of nucleolar material. The present observations, also on *Lolium*, are of interest in relation to the above conclusion for these too can be interpreted as indicating a close relationship between nucleolar formation and prophase development of the chromosomes.

Normally in perennial rye grass, the pmc are uninucleate and the 14 chromosomes show a completely regular meiotic behaviour. A plant which had been subjected to temperature treatment of  $34 \pm 1^\circ \text{C}$ . in a thermostatically controlled heat chamber for a period of 72 hours immediately before fixation showed a high percentage of pmc (20%) which were binucleate. These cells in addition to having a normal nucleus have another which is far from normal. Its chromosomes at early prophase reveal a lack of any organised structure and show little or no improvement in their stainability or spiralsation with the advancing of the nuclear cycle. These obviously retarded chromosomes are always found to be localised in a peripheral position in the cell (Figs. 1 and 2). As the chromosomes in this nucleus do not emerge from their near interphase condition, it is not possible to determine their number but the nuclear volume indicates that none may be missing. The second nucleus occupying a central position undergoes regular prophase development; all its 14 chromosomes condensing to the usual metaphase condition, although they fail to pair and appear as univalents (Fig. 2). There is no anaphase separation and the chromosomes in the central nucleus form one or more restitution nuclei. Those in the peripheral degenerate completely.

Apart from the above dissimilarities, the two nuclei also show another conspicuous difference. This is indicated by the invariable pre-

sence in the central nucleus of a well developed nucleolus, while no such body is formed at all in the peripheral. The pmc for all the above cytological observations were stained in acetocarmine after fixation and storage in Carnoy to which a few drops of ferric chloride had been added.

Binucleate pmc with the two nuclei non-synchronised in their development have been described earlier among others by Holden and Mota,<sup>2</sup> who observed them in an *Avena* hybrid. These authors, from a critical consideration of their own results, particularly the constant relationship between the position and behaviour of the two nuclei and on the basis of evidence presented by La Cour<sup>3</sup> in relation to nuclear differentiation in pollen grains, came to the conclusion that a cytoplasmic gradient in respect of the nuclear-forming substances, accounts for the non-synchronised progress of chromosomes in the binucleate cells. The observations on the treated *Lolium* plant appear in all essential respects to be similar to those on the *Avena* hybrid; furthermore the two non-synchronised nuclei also simulate very closely the degenerating vegetative nucleus and the functional generative nucleus in pollen grains both as regards their origin and subsequent behaviour. As pointed out by Darlington and Mather,<sup>1</sup> in the pollen grains of angiosperms one of the two daughter-nuclei is pressed by the first mitotic spindle against the wall, while the other is left in the middle of the cell. Some of



FIG. 1. PMC showing binucleate condition at early prophase. The central nucleus with a well-formed nucleolus is much more conspicuous than the peripheral which shows poor stainability and lack of nucleolar material,  $\times 1,925$ . FIG. 2. Central nucleus at diakinesis with 14 fully condensed univalents. The peripheral nucleus failing to show any improvement over its early prophase condition,  $\times 1,925$ .

the binucleate pmc in perennial rye grass show the peripheral nucleus so tightly pressed against the cell-wall that the chromatin material is found to take a semi-circular form (Fig. 1). It is obvious that the peripheral nucleus owes its position and distorted form to the asymmetrically placed pre-meiotic mitotic spindle, one of whose poles, too close to the cell-wall, must have been responsible for pressing the chromosomes during anaphase separation.

In view of the above considerations the conclusion reached by Holden and Mota, that cytoplasmic gradient is responsible for the non-synchronised development of the two nuclei in the *Avena* hybrid, can be accepted for the binucleate condition in *Lolium* also. A second suggestion made by these authors to explain the non-formation of nucleolus in the peripheral nucleus, however, requires further consideration.

In the absence of any evidence indicating that the peripheral nucleus lacks an organiser, these authors have suggested that it is possible that the forces operating to maintain the gradient with its focus at the cell centre have also been responsible for the transference of nucleolar material from this nucleus at the preceding telophase. While the existence of a cytoplasmic gradient in the cell is not difficult to visualise particularly in view of the formation of the asymmetrical spindle, it is not very clear how the postulated transference of the nucleolar material may take place. Referring to the fact that the nucleolar material is believed to be intimately associated with chromosome synthesis, Holden and Mota point out that the absence of a nucleolus from the peripheral nucleus is revealing. This obviously cannot be taken to imply that the presence and absence of nucleolus in the central and the peripheral nucleus respectively is directly responsible for the differential behaviour of their chromosomes, for this behaviour has already been explained as due to the cytoplasmic gradient. The significance of these observations, if it can be suggested, lies in indicating that nucleolar synthesis and chromosome synthesis are perhaps related activities and the gradient which is responsible for the failure of prophase development of chromosomes may also be responsible for the non-formation of nucleolar material during the preceding telophase. In other words, the absence of nucleolus in the peripheral nucleus can be explained as due to the failure of the chromosomes to synthesise the materials rather than their removal after synthesis.

Both nuclear differentiation and preferential nucleolar formation in the binucleate pollen

mother-cells would thus appear to be a function of cytoplasmic gradients.

I am indebted to Prof. P. T. Thomas for valuable advice and criticism. My thanks are also due to Prof. E. T. Jones and Mr. A. R. Beddows for their helpful interest; and to the Royal Commissioners, 1851 Exhibition, for the award of one of their scholarships.

Dept. of Agric. Botany, H. K. JAIN,\*  
University College of Wales,  
Aberystwyth, October 30, 1957.

\* Present address: Division of Botany, Indian Agricultural Research Institute, New Delhi-12.

1. Jain, H. K., *Heredity*, 1957, **11** (1), 23.
2. Holden, J. W. and Mota, M., *Ibid.*, 1956, **10** (1), 109.
3. La Cour, L. F., *Ibid.*, 1949, **3** (3), 319.
4. Darlington, C. D. and Mather, K., *Elements of Genetics*, Allen and Unwin, London, 1950.

#### THE FUNGISTATIC AND FUNGICIDAL ACTION OF MYCOSTATIN ON *DEIGHTONIELLA TORULOSUM*

THE inhibitory action of mycostatin on *Deightoniella torulosum* (Ashby) Ell., among other fungi pathogenic to banana, has been reported elsewhere by the authors.<sup>1</sup> The antibiotic was found to inhibit the germination of the spores of *D. torulosum* at 10 mcg./ml., whereas at concentrations lower than 2.5 mcg./ml. there was little or no inhibition and at 5.0 mcg./ml. there were malformations of the germ tube. The results of further studies made to investigate into the nature of action of the antibiotic on the fungal spores are reported here.

Seven-day-old spores of the fungus were treated with aqueous mycostatin at concentrations ranging from 10 to 100 p.p.m. for various lengths of time. They were then washed thoroughly by centrifugation (800 to 1,000 r.p.m.) in several changes of sterile distilled-water and allowed to germinate in 1% sugar solution on depression slides, incubated in moist chambers at room temperature (22 to 28° C.). Proper controls were kept in each case. The germination counts were taken after 24, 48 and 72 hours and the final germination per cent. obtained (Table I). In order to make sure that there was no delayed germination due to the treatment, the ungerminated spores were kept incubated upto the tenth day and observations recorded.

The results indicate that the antibiotic is fungicidal to *D. torulosum*, killing all the spores at all the concentrations tested, the time required for the cidal effect being more at lower concentrations than at higher concentrations.

TABLE I

The effect of mycostatin treatment on the viability of the spores of *Deightoniella torulosum*

Duration of treatment (hours)	% germination at :				
	0 p.p.m.	10 p.p.m.	25 p.p.m.	50 p.p.m.	100 p.p.m.
1 ..	100	94	91	0	0
2 ..	100	86	80	0	0
4 ..	100	89	85	0	0
8 ..	99	68	12	0	0
24 ..	100	19	6	0	0
48 ..	90	0	0	0	0
72 ..	98	0	0	0	0

The effect of mycostatin on the germinating spores of the fungus was also studied. The spores were allowed to germinate in 1% sugar solution. After an interval of 48 hours, when a good number of the spores germinated, aqueous mycostatin, to obtain a final concentration of approximately 5 p.p.m., was added to the medium. Though there was no subsequent growth of the germ tubes, characteristic malformations were observed within 24 to 48 hours. The terminal cells of the germ tubes were malformed into thick-walled, irregular-shaped, brown to dark brown coloured cells, approximately 2 to 3 times broader than the hyphae. These malformations differ from those obtained from the spores pre-treated with mycostatin, in the respect that they are thick-walled and brown-coloured.

The two types of malformations of the germ tubes were washed in several changes of sterile distilled-water and allowed to germinate in 1% sugar solution as before. Even after incubating for 10 days both the malformations failed to germinate, even though some of the attached bits of the normal germ tubes grew well, developing into mycelial strands in the medium.

These results indicate that mycostatin is fungicidal to *D. torulosum* at various concentrations depending upon the time of contact with the antibiotic. The action of mycostatin on the germ tubes seems to be distinct from that of the pre-treatment of the spores with the antibiotic as indicated by the different types of the malformations of the germ tubes obtained. The physiological aspects of these malformations seem to be significantly different from those of the spores as they fail to germinate under the conditions optimum for the normal spore germination and growth of the fungus.

The fungistatic effect of the antibiotic is indicated by the fact that the bits of the normal germ tubes from the treated spores grew into mycelial strands when restored to 1% sugar solution.

G. RANGASWAMI.\*

(MISS) A. P. SAROJANI DAMODARAN.

Mycology and Plant Pathology  
Section,  
Agric. Res. Institute,  
Lawley Road, Coimbatore.  
November 2, 1957.

\* Present address: Head of the Department of Agriculture, Annamalai University, Annamalainagar, Madras State.

1. Rangaswami, G. and Sarojani Damodaran, A. P., "In vitro action of mycostatin on fungi pathogenic to banana," *Indian Phytopath.*, 1957, 10 126.

#### CYTOLOGY OF FERN GENUS *ACROPHORUS*

*Acrophorus* is an interesting isolated genus chiefly represented in the Old World, typified by *A. stipellatus* (Wall.) Moore.<sup>1-3</sup> The second species to be added was *A. raiteensis* J. W. Moore from Raiatea in 1933.<sup>4</sup> A year later Christensen and Holttum<sup>5</sup> grouped a more finely dissected and palæaceous form of the former in a separate species, *A. blumei* Ching apud Chr. (*A. blumei* Ching<sup>3</sup>) from Mt. Kinabalu. Still later Tagawa<sup>6</sup> in 1939 described a new variety, *A. stipellatus* var. *macrostegius* from Formosa. Out of these *A. stipellatus* is indigenous to the mainland of Asia, being distributed throughout the Himalayas and South China while *A. blumei* is restricted to the Malaysian region. The only Indian species, *A. stipellatus*, is very frequent on the forest floor between 6,000 ft. to 10,000 ft. altitude in the Eastern Himalayas and has been sampled from Darjeeling and Sikkim parts of its range.

As to its relationship, it is still a point of controversy. Most of the modern pteridologists like Christensen,<sup>7</sup> Copeland<sup>8</sup> and Holttum<sup>8</sup> hold it to be a close relative of the Dryopteroid ferns especially *Dicalpe* and *Peranema*—the Woodsioid ferns of Bower.<sup>9</sup> Based on almost similar morphological evidences Ching<sup>10</sup> expressed its natural affinities with Davallioid ferns, more with *Leucostegia*, in particular *L. perdurans* Christ and classified it so later.<sup>2</sup> This view has been followed by Dickason.<sup>11</sup> It may here be added that Thompson<sup>12</sup> based on her studies on the sorus and prothallium development in *Acrophorus stipellatus* from Java



supports its Dryopteroid affinity. While a more thorough and complete comparative picture of the various characters of taxonomical importance for the proper understanding of its systematic position awaits publication, this note aims only to place on record the chromosome number for the genus which remains unreported so far.

Acetocarmine squashes of the young sporangia of *Acrophorus stipellatus* (Wall.) Moore, collected at Karponang (10,000 ft.) in Sikkim; Birch Hill forests (7,000 ft.), Senchal forest (8,000 ft.), Lebong forest (5,500 ft.), near Tonglu and Tonglu to Gairabas (8,000 to 10,000 ft.) in Darjeeling District and fixed in 1:3 acetic alcohol, have been obtained. The species exhibits a great variation in its size ranging from 1-5 ft. However, considering the degree of variation, cytologically the species is conspicuous by its extreme uniformity. Perfect regular course of meiosis results in 64 normal and seemingly viable spores. At late diakinesis 41 bivalents become clearly recognisable (Fig. 1) which is thus the haploid number for the genus.

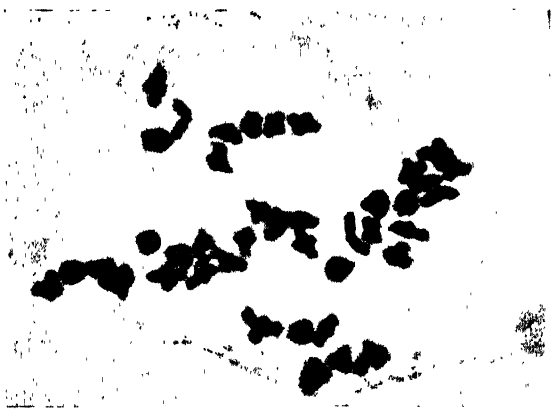

FIG. 1. Late diakinesis in a spore mother-cell of *Acrophorus stipellatus* (Wall.) Moore (Gairabas collection—8,000 ft. alt.) showing  $n = 41$ ,  $\times 1,500$ .

*Leucostegia* as delimited in the modern sense,<sup>3</sup> includes only two species while all the rest have been transferred to the closely allied genus *Araiostegia*. Therefore Ching's reference *L. perdurans* would seem very likely an *Araiostegia*. Among the Davallioids (Davalliaceae of Copeland<sup>3</sup>) *Leucostegia*,<sup>13</sup> *Oleandra*<sup>13</sup> and *Nephrolepis*<sup>13,14</sup> possess 41 as their base number while *Davallia*<sup>14</sup> and *Araiostegia*<sup>13,14</sup> are based on 40. As far as Woodsoid<sup>14-16</sup> ferns are concerned, the number 41 forms the basis of their evolution. The data on the chromosome number of ferns have so far suggested that a given base number usually remains constant in

large, related assemblage and "that aneuploidy tends to characterise the relation between genera rather than between species" (Manton<sup>16</sup>). Hence the cytology alone as such seems to be incompetent in resolving the present tangle unless it is supported by other evidences. Such evidences would appear elsewhere.

The writer is deeply indebted to Professor P. N. Mehra for his helpful guidance, criticism and encouragement during the course of investigation.

Dept. of Botany,  
Panjab University,

S. C. VERMA.

Amritsar, December 14, 1957.

1. Christensen, C., *Index Filicum, Hafnia*, 1906.
2. Ching, R. C., *Sunyatsenia*, 1940, **5**, 201-68.
3. Copeland, E. B., *Genera Filicum*, Chron. Bot., Walth., Mass., 1947.
4. Christensen, C., *Index Filicum Suppl., Tetrium Hafnia*, 1934.
5. — and Holtum, R. E., *Garden's Bull.* (Singapore), 1934, **7**, 226.
6. Tagawa, M., *Acta Phyt. et Geobot.*, 1939, **8**, 230.
7. Christensen, C., *Filicinae in Verdoorn's Manual of Pteridology*, The Hague, 1938.
8. Holtum, R. E., *Biol. Rev.*, 1949, **24**, 267-96.
9. Bower, F. O., *The Ferns*, 1928, **3**, Cambridge.
10. Ching, R. C., *Icones Filicum sinicarum*, Fascicle 1937, **4**, pls. 177.
11. Dickason, F. G., *Ohio Jour. Sci.*, 1946, **46**, 73-108.
12. Thompson, B. F., *Bot. Gaz.*, 1943, **104**, 437-42.
13. Mehra, P. N. and Khanna K. R., *Jour. Genetics*, 1958 (in press).
14. Manton, I. and Sledge, W. A., *Phil. Trans. Roy. Bot. Soc.*, London, 1954, **238 B**, 127-85.
15. Mehra, P. N. and Singh, H. P., *Curr. Sci.*, 1955, **24**, 425.
16. Manton, I., *Problems of the Cytology and Evolution in Pteridophyta*, London, Cambridge Univ. Press, 1950.

#### NOTE ON GONIOZUS SP. (BETHYLIDÆ—HYMENOPTERA) PARASITE OF STEM AND ROOT-BORERS OF SUGARCANE IN BIHAR

SINCE biological control of insects, besides being economic in ultimate analysis, is a permanent means of pest repression, attempts are being made at the Sugarcane Research Institute, Pusa, to collect and study all the parasites commonly associated with the sugarcane-borers in Bihar. The present note incorporates the results of preliminary studies conducted on one of them. This parasite identified as *Goniozus* sp. was reared from parasitised larvae of the stem-borer, *Chilostræa infuscatellus* Snell., and the root-borer *Emmalocera depressella* Swinh. collected from the standing sugarcane crop at the Research Institute's farm during 1956 and 1957. It is an endo-parasite and available

mostly in the months of August-November. Under natural conditions its parasitisation is more pronounced on stem-borers as compared to root-borers. Its full-grown grubs emerge by puncturing the ventro-lateral portion of the host's body and immediately spin closely knit brown silken cocoons within which they pupate. The pupa within the cocoon is creamy white in colour and the duration of this stage varies from 7-9 days during August under laboratory conditions. The maximum number of adults emerging in the laboratory from a cluster of cocoon was, on an average, eleven. The adult female which is quite agile has dark brown colour and hyaline wings. The well developed dentitions of its mandible and the comparatively large size of the hind pair of legs have been observed to confer upon the parasite additional facility in keeping the host under control while parasitising it. The adult of *Goniozus* sp. has a close resemblance to *Goniozus cuttockensis* Lal., the pupal parasite of stem-borer at Cuttack, Orissa, reared by M. Ahmad during 1937 and described by Lal<sup>1</sup> in 1939. Further studies on *Goniozus* sp. are under progress and the detailed observations will be published separately.

The authors are greatly indebted to Sri. K. L. Khanna, Director, Sugarcane Research and Development, Bihar, Pusa, for the facilities and encouragement in the work. Thanks are also due to the authorities of British Museum, London, for so kindly identifying the parasite.

Sugarcane Res. Inst., A. R. PRASAD.  
Pusa, Bihar, S. MOHAMMAD ALI.  
December 20, 1957.

1. Lal, K. B., "Some new species of Hymenoptera from India," *Ind. J. Ent.*, 1939, 1 (3), 51-52.

### THE EFFECT OF CERTAIN INSECTICIDES ON THE LARVAE OF *ANOMIS SABULIFERA* GUENTHER

*Anomis sabulifera* Guenther, commonly known as the jute semi-looper, is one of the major pests of jute. Its larvæ are voracious feeders on leaves and growing apex of both the cultivated species of jute, viz., *Corchorus cap-sularis* and *C. olitorius*.

Jute being a rainy season crop—control of its pests with insecticides is often met with little success as the insecticidal deposits are often washed off by heavy rains or drifted away by high winds in the field. Therefore, the time required to obtain a quick mortality of the pest is of much practical importance.

Dutt and Ganguli<sup>1</sup> and Ganguli<sup>2</sup> have reported earlier the effect of several insecticides in different dosages on the semi-loopers. This brief note presents the results of laboratory investigations with some insecticides, each tested at a particular dosage level, in order to assess their abilities in bringing about a quick mortality of the semi-loopers as a prelude to their application in a larger scale under field conditions.

The insecticides used in these investigations were Folidol E.605, Endrin 19.5% E.C., Aldrin 40% W.P., Dieldrin 50% W.P. and DDT 50% W.P. The comparative toxicity of all these five insecticides has been determined by the method of direct spray (Ganguli, *op. cit.*). The larvæ were bred in the laboratory and only 3rd and 4th instars of them were used as test material. Ten larvæ selected at random and kept in each petridish of 12.5 cm. diameter, forming one replicate were sprayed by means of an atomizer. Quadruplicates were run for each of the five insecticides. Mortality counts at hourly intervals are represented in Fig. 1.

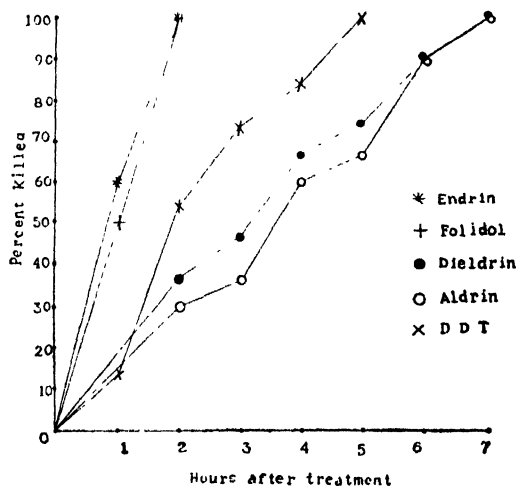

FIG. 1. Effects of Endrin, Folidol, Dieldrin, Aldrin and DDT on the larvæ of *Anomis sabulifera* Guenther.

From Fig. 1 it will be seen that \*Endrin at a dosage level of 0.12% can effect 60% mortality within 1 hour of application and \*Folidol at 0.01% gave 50% mortality. While the corresponding figures for \*DDT at 0.75% being 13%, \*Aldrin and \*Dieldrin both at 0.4% failed to produce any death within 1 hour of application. For effecting 100% mortality Endrin and Folidol took 2 hours, DDT 5 hours and Aldrin and Dieldrin 8 hours. Thus the performances of Endrin and Folidol are bet-

ter than the rest of the insecticides tested under the laboratory conditions.

Thanks are due to Dr. B. C. Kundu, Director, Jute Agricultural Research Institute, Barrackpore, for his keen interest in the work, and to Dr. N. Dutt, Assistant Entomologist, for his suggestions.

Jute Agric. Res. Inst., §R. N. GANGULI.  
Barrackpore, January 10, 1958.

\* In terms of actual insecticidal ingredient.

‡ Present Address: Assistant Entomologist, Tocklai Experimental Station, Cinnamara P.O., Assam.

1. Dutt, N. and Ganguli, R. N., "Comparative effectiveness of some insecticides for control of *Anomis sabulifera* Guen. (Jute semi-looper)." *Proc. 43rd Indian Sci. Cong.*, 1956, Part III, 387.
2. Ganguli, R. N., *The Possibilities of Control of Jute Semi looper (Anomis sabulifera Guen.) by Folidol E. 605* (in the press, *Hofchen Briefe*), 1957.

#### A TECHNIQUE FOR ISOLATING PATHOGENIC CULTURES OF *PYTHIUM* FROM THE SOIL

SPECIAL techniques are needed for isolating certain groups of fungi from the soil as these do not ordinarily appear on the dilution plate. Sadasivan<sup>1</sup> and others have successfully used the 'straw burial' method for isolating fusaria from the soil. The use of sterilized insects for isolating phycomycetes is a common practice. Pathogenic fungi are mostly isolated from infected host tissue. Rands and Dopp<sup>2</sup> transferred bits of rotted roots of sugarcane or the soil adhering to them to sterilized soil in which a susceptible variety was planted. The root-tips of the new seedling developed rot lesions and yielded the *Pythium* concerned, on being plated out. In my experience this method yielded the pathogen only from a relatively small number of the 'live baits' used. Further, rot-affected roots are essential as a 'starter' and it is not possible with this method to demonstrate the presence of the root rot organism in the soil in the absence of the actual occurrence of the disease.

A technique tried in this Institute in connection with a study of sugarcane root rot, has frequently yielded isolates of *Pythium* and other phycomycetes even in the absence of a previous case of root rot. Soil is filled into a pot and one or more single-eyed sugarcane cuttings are planted. The soil is watered to saturation. The pot is now covered by inverting over it another pot of a slightly smaller size so that, light is completely excluded. The moisture content of the soil is maintained at

near saturation level by means of capillary irrigation. Three to four weeks later the cover is removed, the plants are taken out and the roots are washed free from soil. Many of the roots show discrete red lesions and the pathogen is isolated by plating bits of the roots after repeated washing in sterile water. Often the aetiolated shoot is invaded and the surface is covered by cottony growth of fungal mycelium. Direct transfers from this frequently yield pure cultures of *Pythium*. This is probably due to the high humidity of the enclosed chamber and the exclusion of aerial contaminants.

When a highly susceptible variety like Co. 467 was used, isolates of species of *Pythium* were obtained more frequently (65%) than when a resistant variety like Co. 617 was used (15%).

Carpenter<sup>3</sup> found that heavy applications of nitrogen predisposed sugarcane plants to *Pythium* root rot attack. The unbalanced carbon-nitrogen ratio in the tissues of the aetiolated plants produced with the technique under report is possibly responsible for the ease with which the pathogen attacks the tissues. In one experiment ammonium sulphate solution was added to the soil before covering the pots. The ammonium sulphate-treated plants yielded species of *Pythium* in 18 out of 20 cases while in the absence of the fertilizer only 11 out of 20 gave *Pythium*.

The majority of isolates obtained by this method from sugarcane soils belonged to *Pythium graminicolum* Subram. and *P. debaryanum* Hesse. A few isolates of *P. aphanidermatum* (Eds.) Fitz. and other species and occasional isolates of an undetermined phycomycete were also obtained. In infection tests all the isolates proved to be pathogenic to sugarcane (variety Co. 419) in varying degrees.

Employing this technique the presence of pathogenic species of *Pythium* was demonstrated in a number of soils both in the alkaline as well as the acid range. The possibility may be envisaged of isolating pythiaceous fungi pathogenic to various species of plants by using the appropriate host.

I am grateful to Mr. N. L. Dutt, Director of this Institute, for encouragement.

Sugarcane Breeding Inst., K. V. SRINIVASAN.  
December 20, 1957.

1. Sadasivan, T. S., *Ann. Appl. Biol.*, 1939, **26**, 497-508.
2. Rands, R. D. and Dopp, E., *U.S.D.A. Tech. Bull.*, 1938, 666.
3. Carpenter, C. W., *Hawaii. Planters' Rec.*, 1928, **2**, 107-17.

### MALE STERILITY IN *CROTALARIA STRIATA*

In a collection of species of *Crotalaria* maintained at the Agricultural College, Hebbal, Bangalore, a single plant was noticed in a line of *Crotalaria striata*, D.C. with poorly developed anthers, in 1956. The flowers opened normally, the anthers were small, green, empty and did not dehisce; while in the normal plants the anthers were big, yellow and plumpy (Fig. 1) with abundant yellow pollen. On



TEXT-FIG. 1. Anthers of a normal flower (right) and those of the male sterile flower (left).

squashing the poorly developed anthers in a drop of acetocarmine all the microspores were found to be shrivelled up and devoid of any contents. Some of the inflorescences were covered with bags and no pod and seed formation was found while the inflorescences under open and cross-pollinations bore pods and seeds. It could therefore be inferred that the plant was male sterile. The many known cases of heritable male sterility are controlled by either genetic or cytoplasmic factors or by gene-cytoplasm interaction. In our material the plants raised from seeds collected on the male sterile plant, under open pollinated condition were also male sterile. This may be due to either the male sterile gene being dominant over the normal or male sterility being under cytoplasmic control. So far, male sterile genes under the control of nuclear gene have been reported in the recessive state only (Beadle, 1932). If alternatively, the gene is of the cytoplasmic type, it should be possible to find out whether there are any fertility restorer genes in the normal complement. With this in view, male sterile plants have been crossed with a number of normal ones and the results are awaited. Since the hybrids between male sterile  $\times$  normal exhibited luxurious vegetative growth, there may be possibility of using the

male sterile plant for exploiting hybrid vigour in this green manure crop.

We wish to acknowledge with thanks the facilities and the encouragement given by Sri. B. Venkoba Rao, Principal, Agricultural College. We are also grateful to Sri. S. S. Rajan, Assistant Cytogeneticist, Indian Agricultural Research Institute, New Delhi, for his help in the preparation of the manuscript.

Agricultural College, C. KEMPANNA,  
Hebbal, K. S. KRISHNA SASTRY.  
Bangalore-6,  
January 16, 1958.

1. Beadle, G. W., *Genetics*, 1932, 17, 413-31.

### OBSERVATIONS ON THE SEAWARD MIGRATION OF *MUGIL CEPHALUS LINNAEUS* FROM THE CHILKA LAKE FOR BREEDING\*

SAROJINI,<sup>1</sup> in a review on the biology of Indian grey mullets, has invited attention to the conflicting views as to the habitat where the estuarine species of the Indian mullets breed and Thomson<sup>2</sup> has mentioned of observations by Australian, Egyptian, S. African, Japanese and American biologists on the breeding of *Mugil cephalus* Linnacus in particular. The consensus of opinion favours sea-breeding of *M. cephalus* recognising the possibility of occasional breeding in barred estuaries or in lagoons where salinity approximates that of the sea. The observations of Nair,<sup>3</sup> Belloc<sup>4</sup> and Dill<sup>5</sup> may thus fall in line if this view is held. It, however, remains that the coast breeding habit of *M. cephalus* is yet to be finally confirmed (Kesteven<sup>6</sup>).

Mulletts, as a group, constitute the most important fishery of the Chilka Lake among fishes and *M. cephalus*, among mulletts, is the most dominant species followed by *Liza troschelli* (Bleeker). Little definite has hitherto been known about the breeding migration of any species of Chilka mulletts of which ten are known to occur in the lake. A precise knowledge of the pattern of migration of Chilka mulletts has a direct bearing on the conservation programme of the lake's mullet fishery.

Observations made in the outer channel part of the lake, in the lake mouth proper and in the sea-board adjoining the lake mouth, in the months October to December 1957, throw

\* Published with the permission of the Chief Research Officer, Central Inland Fisheries Research Station, Calcutta.

light on the migration of *M. cephalus* from Chilka Lake into the sea for breeding. The migrating *M. cephalus*, the male among which averaged  $373.5 \pm 2.15$  mm. and the female  $534.24 \pm 4.34$  mm. in total length in October 1957, are caught by cast nets in the outer channel generally during high-tide, and schools of migrating fish, with their heads slightly projecting out of water, can be clearly seen particularly while traversing the narrow lake mouth (about 200 yards wide in high-tide). Cent. per cent. of the migrating fish are in Stages V to VI of maturity following Kesteven's<sup>7</sup> criteria. On reaching the sea, these mullets appear to keep close to the shore at both the north-eastern and south-western parts of the coast. Local fishermen capture them in fair numbers from the breakers with stick nets (Khari Jal) operating the gear in inter-tidal zone from the beach itself. During the autumn and winter months ripe *M. cephalus* (males averaging  $396.1 \pm 4.83$  mm. and females  $538.26 \pm 2.67$  mm. in total length in October 1957) captured from the sea in the vicinity of the lake mouth, forms a lucrative fishery. Schools of mullets are often very clearly seen in the sea through the wave crests under favourable conditions of light. These fishery observations corroborated by certain others such as the availability of mullet fry in the sea, even far away from the lake mouth, their migration from the sea into the lake, appearance of spent fish and other relevant observations are being made and data analysed. There is also evidence available to demonstrate similar migratory habit of certain other mullets of the Chilka Lake like *Liza troschelli* (Bleeker), *L. borneensis* (Bleeker), *L. ceruleomaculatus* (Lacepede) and certain other smaller mullets collectively called "Menjia" in local terminology. The details of these observations will be published elsewhere.

Chilka Investigation Unit, V. G. JHINGRAN.  
Balugan (Orissa).  
January 29, 1958.

1. Sarojini, *J. Zool. Soc.*, 1951, 3 (1).
2. Thomson, *Aust. J. Mar. Freshw. Res.*, 1950, 1 (2).
3. Nair, *Bull. Cent. Res. Inst. Univ. Trav. Ser. C.*, 1957, 5 (1).
4. Belloc, *Rapp. Comm. Int. Mer. Medit.*, 1938, 11.
5. Dill, *Calif. Fish. Game*, 1944, 30 (3).
6. Kesteven, *Aust. J. Mar. Freshw. Res.*, 1953, 4 (2).
7. —, *Conn. Sci. Industr. Res. Aust. Bull.*, 1942, No. 157.

#### NOTE ON *HYMENIA FASCIALIS* C. A PEST OF SUGARBEET

SUGARBEET (*Beta vulgaris*) like any other crop is attacked by various insects at each and every stage of its growth from germination till harvest. The species recorded at Pusa (Bihar) include: *Plusia nigrisigna* Walker,\* *Chalciope hyppasia* Cram.,\* *Diacrisia todara* Moore,\* *Marasmia trapizalis* G., *Margaronia indica* S., *Schænobius incertullus* W., *Spodoptera mauritia* B., *Plusia orichalcia* and *Hymenia fascialis* C.

The biology of some of these pests as also preliminary trials to compare the efficacy of various insecticides against these pests were conducted in the laboratory at Sugarcane Research Institute, Pusa (Bihar), with a view to controlling the same. These include: *H. fascialis*, *S. mauritia* and *P. orichalcia*.

Slender, light green coloured, leaf-eating caterpillars of *H. fascialis* were observed in the field as early as March, when on an average 9.6% leaves of sugarbeet were found damaged by this pest. The activity of the larvæ kept on increasing gradually till July when the average infestation was as high as 47.8% and thence onwards the activity started decreasing. The larvæ collected from field, pupated, emerged and laid eggs by third week of March and thereafter the duration of each stage under laboratory conditions was as in Table I.

There was overlapping of broods, and the ratio of males to females in all the generations was on an average 2:1.

The efficacy of 5% BHC, 5% DDT, 5% Aldrin and 2.5% Dieldrin dusts was compared in controlling this pest in the laboratory. Sugarbeet leaves dusted uniformly, two leaves with each of the insecticide, were kept in the glass jars. In one of the glass jar, two untreated leaves (control) were also kept. In each of these glass jar, 20 full-grown larvæ were liberated and observations regarding their mortality and pupation were recorded daily. The experiment was replicated five times. The data collected has been summarised in Table II.

The above results show that Dieldrin and Aldrin are superior to BHC and as good as DDT. Within 24 hours 80%, 70% and 70%

\* Sincere thanks are due to Dr. W. H. T. Tams, of British Museum (Natural History), London, for very kindly identifying the specimen. The author is greatly indebted to Mr. K. L. Khanna, Director, Sugarcane Research & Development, Bihar, for very kindly suggesting the problem and providing the necessary facilities.

TABLE I

Month	Incubation period (days)	Larval period (days)	Pupal period (days)	Longevity (days)	Average temperature in °F.	Average difference of Max. & Min. temp.	Relative humidity	
							Morning	Evening
April	.. 2	11.38	8.00	4.17	85.52	30.65	60.35	25.88
May	.. 2	10.50	7.50	2.33	87.51	21.87	79.16	40.15
June	.. 2	9.00	5.50	2.00	85.19	9.82	86.84	72.11
July	.. 2	9.40	5.78	4.67	83.69	7.38	92.58	86.26

TABLE II

Treatments	1st day		2nd day		3rd day		4th day		5th day		6th day		7th day	
	Mortality %	Pupated %	Mortality %	Pupated %	Mortality %	Pupated %	Mortality %	Pupated %	Mortality %	Pupated %	Mortality %	Pupated %	Mortality %	Pupated %
	5% BHC	.. 30	nil	50	nil	10	nil	10	nil	..	..	..	..	..
5% DDT	.. 70	nil	10	nil	20	nil	..	..	..	..	..	..	..	..
5% Aldrin	.. 70	nil	30	nil	..	..	..	..	..	..	..	..	..	..
2.5% Dieldrin	.. 80	nil	20	nil	..	..	..	..	..	..	..	..	..	..
Control	.. nil	nil	nil	nil	10	10	nil	10	20	nil	nil	20	10	nil

mortality was obtained with Dieldrin, Aldrin and DDT respectively as against 30% in case of BHC. Further trials are in progress and details of the investigations will be published separately.

Sugarcane Entomologist, DHAMO K. BUTANI.  
Sugarcane Res. Inst.,  
Pusa (Bihar), February 25, 1958.

### INHERITANCE OF THE TINY-LEAVED AND ALTERNIFOLIA FORMS IN *CICER ARIETINUM* L.

THE *Alternifolia* form was described by the author in 1952, mentioning it to be recessive to the normal bi-pinnate leaf and segregating with it in a monogenic manner. This type was subsequently hybridized with the *Tiny-leaved* mutant (Ekbote, 1937), which was shown to have behaved as a recessive to the *Normal-leaved* one and determined by a pair of genes designated as *tlv tlv* (Ekbote, 1942).

As a result of crosses made among several leaf mutations in *Cicer*, Singh and Bhagchandani (1953) symbolized the normal bi-pinnate compound leaf as *Slv Slv Tlv Tlv Nlv Nlv* and the *Tiny-leaf* as *Slv Slv tlv tlv Nlv Nlv*. From a study of a cross between the *Tiny-leaved* and the *Gigas* forms, Chaudhari and Argikar

(1957) symbolised the *gigas* form as *Slv Slv Tlv Tlv Nlv Nlv glv glv* and the *tiny-leaved* mutant as *Slv Slv tlv tlv Nlv Nlv Glv Glv*.

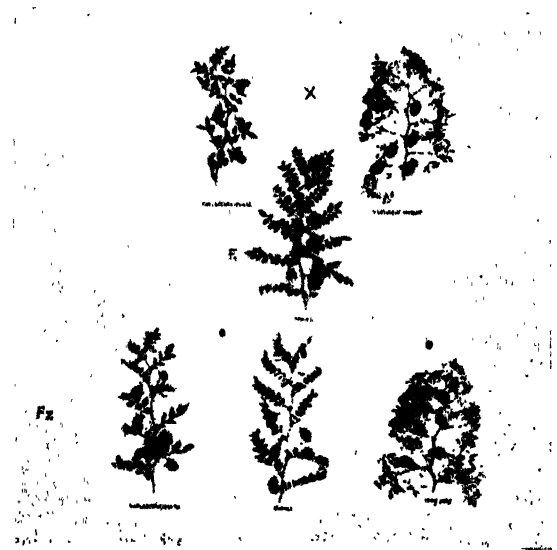

On finding that the interaction of the genes involved in the *Tiny-leaved* mutant and the *Alternifolia* plant also produce the *Normal-leaved* condition, it is proposed to further

F <sub>2</sub> Phenotype	Genotype	No. of F <sub>3</sub> progenies	F <sub>3</sub> frequencies	Ratio	X <sup>2</sup>	P value
<i>Normal-leaved</i> ..	Tlv Tlv	5	106 <i>normal leaved</i>	True breeding	..	..
	Alv Alv					
	Tlv Tlv	6	190 <i>normal leaved</i>	3 : 1	0.08	0.20—0.50
	Alv Alv		66 <i>tiny-leaved</i>			
	Tlv Tlv	35	968 <i>normal-leaved</i>			
	Alv alv		399 <i>alternifolia</i>	9 : 3 : 4	12.92	0.001—0.01
		459 <i>tiny leaved</i>				
	Tlv Tlv	12	411 <i>normal leaved</i>	3 : 1	2.32	0.10—0.20
	Alv alv		158 <i>alternifolia</i>			
<i>Alternifolia</i> ..	Tlv Tlv	17	809 <i>alternifolia</i>	True breeding	..	..
	alv alv					
	Tlv Tlv	18	641 <i>alternifolia</i>	3 : 1	1.41	0.20—0.50
alv alv		244 <i>tiny-leaved</i>				
<i>Tiny-leaved</i> ..	tlv tlv	17	783 <i>tiny-leaved</i>	True breeding	..	..
	Alv Alv					
	tlv tlv					
	Alv alv					
	tlv tlv					
	alv alv					

designate the *Alternifolia* form, which was earlier designated as al al (Bhat and Argikar, 1952) and reported to be recessive to the normal, as Slv Slv Tlv Tlv Nlv Nlv Glv Glv alv alv and the *Tiny-leaved* one as Slv Slv tlv tlv Nlv Nlv Glv Glv Alv Alv, the mode of their inheritance being as follows :

Cross: *Tiny-leaved* mutant *Alternifolia*  
 tlv tlv Alv Alv × Tlv Tlv alv alv  
 F<sub>1</sub> hybrids: *Normal-leaved* (bi-pinnate compound)  
 Tlv tlv Alv alv

The F<sub>2</sub> frequencies were :

	Normal-leaved	Alternifolia	Tiny-leaved
Observed	113	62	65
Expected on a 9:3:4 ratio	135	45	60

X<sup>2</sup> = 10.40 P between 0.001 to 0.01. The fit is good.

The F<sub>3</sub> segregation was of the following order :

The results obtained in the F<sub>3</sub> generation cited above confirm the F<sub>2</sub> findings proving the dominance of the *Normal-leaved* plant, which in its homozygous state could, therefore, be symbolized as Slv Slv Tlv Tlv Nlv Nlv Glv Glv Alv Alv, thus comprising of at least five pairs of factors.

Grateful thanks are due to Dr. S. Solomon, Deputy Director of Agriculture (Crop Research), Bombay State, Poona, for the very

keen interest evinced by him in the above study.

Crop Res. Section, G. P. ARGIKAR.  
 Poona-5, December 28, 1957.

1. Argikar, G. P., *Jour. Ind. Bot. Soc.*, 1952, 4, 362-69.
2. Chaudhary, B. B. and Argikar, G. P., *Curr. Sci.*, 1957, 26, 395.
3. Ekbote, R. B., *Ibid.*, 1937, 5, 648.
4. —, *Ind. Jour. Genet. Pl. Breed.*, 1942, 2, 50-56.
5. Singh, H. B. and Bhagchandani, P. M., *Ibid.*, 1953, 2, 106-08.

#### TRACHEAL CONCENTRATION IN THE ABDOMEN OF TWO SPECIES OF COLEOPTERA

IN recent years considerable attention is paid to the morphology of the respiratory system of insects because of its great physiological significance. Amongst the more recent and notable contributions are those of Keilin<sup>1</sup> and Whitten.<sup>2-4</sup> Whitten<sup>2</sup> first noted the close association of the nervous concentration and the tracheal displacement in Cyclorrhaphus Diptera. I have shown elsewhere (Tonapi<sup>5</sup>) that such a displacement does not occur in the Hymenopteran adults. The ventral commissures of Hymenoptera retain their segmental disposition even when the ganglia of their segments are forwardly displaced. A similar tracheal displacement has also been noted by me for the first time in the abdomen of two adult Coleoptera. In *Holotricha serrata* Fabr., it is possible to recognise three metameric tracheal components

in the abdomen: (a) lateral abdominal trachea, (b) spiracular trachea, and (c) the dorsal branch or anastomosis. Ventral commissures are absent. Visceral tracheae are highly irregular in their distribution. These as well as the dorsal branches have a number of large and small vesicles. In addition to the above elements, there is a ventral tracheal concentration (Fig. 1). These ventral abdominal tracheae

saccular dilatation. Absence of the ventral commissures and presence of such concentration instead suggests that they are comparable and are probably homologous.

In *Oryctes rhinoceros* L., a typical metameric element consists of (a) lateral abdominal trachea, (b) spiracular trachea, (c) a dorsal branch or anastomosis, and (d) a ventral commissure. The visceral elements are highly irregular. There is an enormous development of large and small vesicles. In addition to the above elements, there is a ventral tracheal concentration. It is interesting to note that the tracheal concentration is dorsal to the ventral commissures which, however, retain their segmental disposition.

In both cases referred to above, the ventral tracheal concentration is on the sternites. But it is not yet clear if this displacement is due to the ventral nerve cord as in *Cyclorhaphus* Diptera. Since the scheme of tracheal distribution differs markedly in both the species, it is not possible to elucidate the homologies at this stage. Further studies are in progress and will be reported later.

I am grateful to the Ministry of Education, Government of India, for the award of a National Research Fellowship. I am indebted to Dr. S. P. Agharkar, Director, Maharashtra Association for the Cultivation of Science Laboratory, for facilities and encouragement.

M.A.C.S. Laboratory, G. T. TONAPI,  
Law College Buildings,  
Poona-4, February 17, 1958.

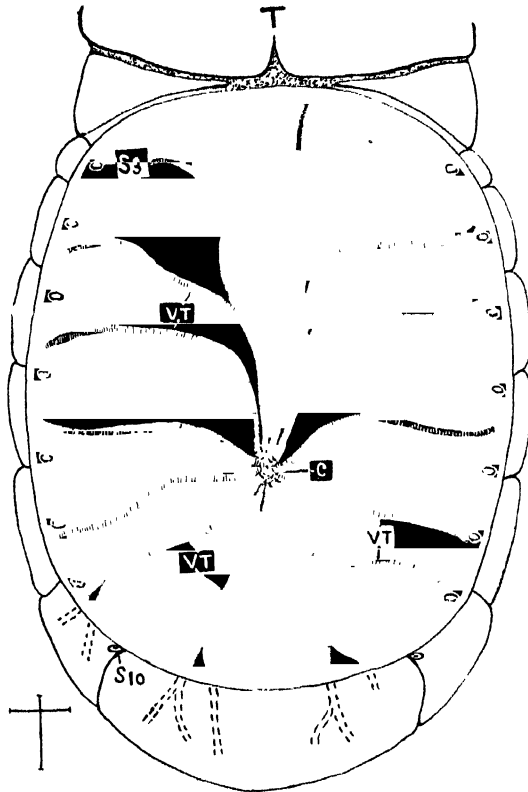

FIG. 1. Ventral tracheal system of the abdomen of *Holotricha serrata* Fab. (Diagrammatic). Lateral abdominal tracheae, spiracular tracheae and dorsal branches are not shown. C = Place of tracheal concentration. VT = Ventral trachea. S = Spiracle. T = Metathorax.

are given off in each segment by the lateral abdominal tracheae. They converge ventrally in the fourth segment and are devoid of any

1. Keilin, D., *Parasitology*, 1944, **36**, 1-66.
2. Whitten, J. M., *Quart. J. Micr. Sci.*, 1955, **96**, 257-78.
3. —, *Proc. Roy. Entomo. Soc. Lond. (A)*, 1956, **31**, 105-08.
4. —, *Quart. J. Micr. Sci.*, 1957, **98**, 123-150.
5. Tonapi, G. T., *Ph.D. Thesis*, University of London, 1955.
6. —, *Proc. Ind. Sci. Cong.*, 1958, **3**, 353.
7. Wigglesworth, V. B., *Quart. J. Micr. Sci.*, 1950, **9**, 217-24.



---



---

## REVIEWS

---



---

**Water Waves.** (*Pure and Applied Mathematics*, Vol. IV.) By J. J. Stoker. (Published by the Interscience Publishers, Inc., N.Y., India: Asia Publishing House, Bombay-1), 1957. Pp. xxviii + 567, Price \$ 12.00.

In attempting to assess the position of Einstein's theory of gravitation today, J. L. Synge expressed the opinion (*Advancement of Science*, Vol. 14, No. 55, Dec. 1957, p. 207), that as matters stand at present, one may look forward to a good hundred years of work before a mastery over Einstein's theory is achieved. To justify this statement, he pointed out that it took about two centuries for the mathematical physicists to gain a thorough mastery over Newtonian theory, and indicated further that they are still working hard at it, mentioning as one instance, the theory of water waves which, in his opinion, is still far from complete.

The book under review which deals with flows in water exclusively on the basis of the classical hydrodynamics of non-viscous and incompressible fluids brings out clearly in what sense one can consider the theory of water waves as still being far from complete. In the very first chapter on basic hydrodynamics, the surface wave problem is formulated in all thoroughness, and it is indicated how difficult it is to solve it consequent on its non-linear nature, on the facts that the free surface is not known *a priori* and that the boundary varies with the time, and lastly on the circumstance that any mathematical formulation which would fit with observation even for a limited time would necessitate postulating the existence of singularities of unknown location, both in space and time. In view of these it is pointed out that the solution of problems in the full non-linear version of the theory will, for a long time to come, continue to be of the nature of existence theorems for motions of rather a special nature.

The great merit of the book however lies in showing, that in spite of the mathematical difficulties inherent in the general problem, it is possible to obtain results of real physical interest, highly significant for practical applications, by building up a suitable approximate theory. Nearly 95% of the book deals with two such approximate theories based respectively on the assumptions of small wave amplitudes, and small depth of liquid relative to the wavelength in both cases. It is worthy of note that two such simple and reasonable approximations

should lead to the possibility of discussing a great variety of problems relating to phenomena of everyday occurrence in nature. In fact, this book is a veritable mine of information on topics connected with water waves, and it would be no exaggeration to say that it is perhaps the finest book on this subject so far written.

In a sense, this is a difficult book to review, for, one of the main functions of a reviewer, *viz.*, to indicate briefly the nature and extent of several parts of the book and of the problems dealt therein has been admirably performed by the author himself in the beautiful introduction to the book. It is rarely that one comes across a book like this in which the introduction serves the purpose of describing precisely what the book purports to achieve, thus making it easy for a reader with some knowledge of hydrodynamics to pick out immediately the particular topic in which he is interested, without wandering throughout the book. Apart from the introduction, the book itself can be considered as a model of clear, simple and rigorous scientific exposition. A reasonable balance has been achieved between the mathematics and the physics of the several problems treated, and a clear distinction maintained between physical assumptions and mathematical deductions. The author has mentioned in the introduction that he has attempted to model his writing on the works of Darwin, Huxley and Tyndall, in particular on Tyndall's book on Sound which, in the author's opinion, is to be regarded as a great classic of scientific exposition. We venture to predict that this book under review will also remain a classic on the subject for a long time to come, although its contents may come to be superseded by later researches.

Some of the striking physical problems dealt with are those relating to waves on sloping beaches and against vertical cliffs; ship waves and motion of a ship including wave patterns created by a moving ship; motion resulting from the breaking of a dam, the breaking of waves in shallow water, and the problem of the solitary wave; meteorological applications connected with cyclonic disturbances; and the theory of tides in the oceans and oscillations in lakes and harbours. The most interesting part of the book is the long Chapter Eleven on the subject of Mathematical Hydraulics dealing with

numerous problems relating to flows and wave motions in rivers and open channels. A particular topic treated in this chapter which is bound to be of vital interest to hydraulic engineers in India is the one which deals with floods in rivers and prediction of floods. There is a lot of empirical work on this subject done by our civil engineers which is perhaps not always based on exact scientific methods, and we would therefore specially like to bring this chapter to the notice of such workers.

Even on the mathematical side, the book has many surprises to offer. The first approximation of small wave amplitudes reduces the problem to the usual potential theory based on Laplace's equation, but special types of problems lead to the existence of mixed boundary conditions (i.e., of  $\phi$  and  $\delta\phi/\delta n$ ) which even at this late date have generally been neglected. Again, it is curious to find that gravity wave problems, solutions of which satisfy Laplace's equation should require, for uniqueness, conditions at infinity of the 'radiation type that occur in Sommerfeld's diffraction problem. The second approximation of small depth brings out the unexpected result that, although one is dealing here with an incompressible non-viscous fluid theory, the non-linear partial differential equations along with the modified surface conditions are analogous to the equations of motion of compressible gases, even including phenomena analogous to the occurrence of shock waves in gas dynamics. Lastly, we have another unexpected result that some problems of the general theory (without either of the two approximations) could be solved by using the Lagrangian representation rather than the Eulerian representation of fluid mechanics.

The book is excellently printed, and contains beautiful figures and photographs, and a valuable bibliography of recent literature on the subject. In the summary prefacing Part II of the book, it is mentioned in the last paragraph on p. 36 that an Appendix to this Part containing a brief report of some of the more recent literature is given at the end of the Part, but we have searched in vain to find such an Appendix. We have mentioned this fact just because it is an important function of a reviewer to search for lacunæ, however trivial, and point them out.

In conclusion, we would like to repeat that this is a most beautiful book, and can well be considered a classic on the mathematical theory of wave motion in liquids, and its applications.

B. S. MADHAVA RAO.

**Crystal Structures.** (*Loose Leaves with Binders, Supplement III to Chapters I-VIII.*) By R. W. G. Wyckoff. (Interscience Publishers, New York; India: Asia Publishing House, Bombay-1), 1958. Price \$ 20.00.

This well-known work of Prof. Wyckoff has been published in loose leaf form and comprises of five volumes. The first three of these contain data for Inorganic Compounds, while the fourth and fifth is devoted to Organic Compounds. The entire material is presented under fifteen chapters. Supplements have appeared from time to time and instructions have been given for filling the material properly, in correct places and making up the volumes. The present instalment called Supplement III consists of additional sheets to go into Chapters I-VIII. These accordingly go into Volumes I and II.

In this supplement, data for new compounds and data based on recent determinations and re-examinations of several of the older compounds have been presented, with relevant discussions, tables and illustrations. References have been extended up to the year 1955 (from 1949 to 1955).

The results of study of a large number of rare earth metals radioactive and transuranic elements and several polymorphic transformations are given. Further, low temperature crystallography has in recent years marked a notable progress. One, therefore, finds structure determinations at low temperatures reported and discussed, e.g., solid chlorine, hydrogen cyanide, hydrogen peroxide, pentaborane, etc.

Numerous illustrations form the bulk of this Supplement, and with the addition of these the Volumes I and II comprising (I-VIII) chapters have been greatly enriched in their contents and usefulness.

As regards this publication, it is a treasure-house of information, invaluable to students of crystallography, crystal physics and crystal chemistry.

---

**The Rolling of Strip, Sheet and Plate.** By Eustace C. Larke. (Chapman & Hall, Ltd.), 1957. Pp. xi + 404. Price 63 sh.

In bringing out this book, the author has performed a very valuable service to students of metallurgical engineering and also to those concerned with rolling mill design and practice. The book deals with fundamentals of design and operation of rolling mills and

important investigations in this field. The author's expert knowledge of the subject has also augmented the subject-matter of the book.

The first two chapters describe various rolling plants including the modern Sendzimir and planetary roll mills making generous use of photographs of operating rolling plants. The next two chapters discuss design and production of roll camber and causes and control of gauge variation. Chapter Five discusses various factors affecting the rolling load such as rate of deformation, front and back tensions, etc., without going into the rigorous derivation for the roll separating force based on the theory of plasticity. The following chapters deal mainly with practical application of the principles and include the design of rational rolling schedule to ensure maximum production, the calculation of the hot and cold rolling loads, the effect of front and back tensions, various factors affecting the mean rate of deformation and the mean resistance to deformation in hot rolling.

The last three chapters are devoted to the calculations of energy consumed, horsepower developed in cold and hot rolling and factors affecting the productivity of strip mills. *viz.*, the handling time, weight and length of coil, etc.

Thus the first few chapters are devoted to design principles and the remaining to their practical applications. To emphasize the practical aspects, numerous worked-out examples are included and will be of great use to students.

The book is profusely illustrated with photographs, graphs, tables and worked examples, and a large list of references is also given at the end. These will help the reader considerably. Apart from an occasional printing error, the book is well presented.

R. C. DESHPANDE.

chemistry (digestion, absorption, transport and storage); and Vol. III, Biochemistry (biosynthesis, oxidation, metabolism and nutritional value). This volume (Vol. III) completes the series.

The present volume has kept up the excellent tradition of the earlier ones by the same author. The exhaustive treatments of the chapters on biosynthesis, oxidation and metabolism of triglycerides will be most useful to students of biochemistry. Some of the most fascinating and rapidly developing fields of biochemistry have been very ably summarised in these chapters. The chapters on metabolism of cholesterol, carotenoids and of vitamin A also will be found equally profitable. Those on essential fatty acids and nutritional value of fats are extremely informative and timely and the classical controversy over the comparative nutritive values of butter and margarine between the Wisconsin School and Deuel himself will be read with great interest. Prof. Deuel had long practical experience, and has made significant contributions, in all these fields and the reviewer cannot think of a more suitable person that could do better justice to these topics.

A cursory glance through the three formidable volumes would leave one rather overwhelmed, as only wide experience, clear knowledge, hard work, drive, energy and confidence can lead one to undertake such a stupendous task and Deuel had all of them. All the three volumes are neatly arranged and exhaustively written in clear language. Collection of literature is probably complete. All universities, research institutions and other places of learning will feel compelled to procure all of them, as nowhere else so comprehensive collection of literature will be found, and the individual workers will only wish that they were little cheaper, as all three of them together will cost almost a fortune.

J. GANGULY.

---

**Lipids, Their Chemistry and Biochemistry,** Vol. III. By Harry J. Deuel, Jr. (Published by Interscience Publishers, Inc., New York and London; India: Asia Publishing House, Bombay-1), 1957. Pp. xxxvi + 1065. Price \$ 25.00.

Prof. Deuel had initially planned on writing one book on lipids, but very soon it became clear to him that it had to be split into two volumes: Vol. I, Chemistry; and Vol. II, Biochemistry. With progress of time he had to revise his plans still further and split the Biochemistry part into two volumes: Vol. II, Bio-

---

**Dry Battery Receivers with Miniature Valves.** By E. Rodenhuis. (Philips Technical Library; India: Philips Elec. Co., 7, Justice Chandra Mehtab Road, Calcutta), 1957. Pp. viii + 240. Price 32 sh. 6d.

The book begins with a brief introduction to the development of modern battery valves and battery receivers. The greatest drain on the energy source which has only a limited life in battery-operated receivers is to be attributed to the greater current consumption by the filament. In evolving suitable tubes for battery operation, this consideration weighed heavily on

the design. The successful culmination of tube design, whose filament current consumption was considerably low (150 mA, 50 mA and even 25 mA) depended on many-sided development. Three requirements had to be laid down to ensure this, (i) the tungsten wire had to be drawn very fine, (ii) the emissive coating had to be very thin, (iii) and the space between filament and grid had to be reduced in order to maintain the mutual conductance.

It has been possible to draw very fine tungsten wire (of the order of  $10\mu$ ) which were cataphoretically coated with a very thin layer of barium. With the realisation of these three requirements Philips have brought out the so-called "D" series valves. The modern battery receivers fall into three groups: (1) Portable receivers, (2) Battery/mains receivers, and (3) Domestic receivers, and in the Philips list of tubes one could choose tubes to suit any of the above-mentioned applications. In the book under review, complete data and characteristics for twelve of these are given. The applications of these tubes and practical circuits in which they are used, are elaborately discussed. The material presented fall under six chapters. Chapter I: Introduction; Chapter II: Miniature Battery Valves with 50 mA Filament; Chapter III: Electronic Tuning Indicators, DM 70 and DM 71; Chapter IV: Miniature Battery Valves with 25 mA Filament; Chapter V: Problems of Dry Battery Valve Supply; and Chapter VI: Circuit Considerations. Seven circuits which have been actually constructed and tested are given in the last chapter using Philips valves, complete with circuit diagrams and component values.

In Chapter V a very useful discussion of the problems that arise in connecting the filaments in series or in parallel according to the type of receiver is given. The book provides complete technical data and characteristics of dry battery receiver tubes and contains highly useful discussions, invaluable to the hobbyist, who is interested in constructing his own set, or to the service engineer or to designers. Unfortunately, however, a few mistakes have crept into the book which are of a minor nature and it is hoped that these would be rectified in later editions.

A. J.

---

**Insect Flight.** By J. W. S. Pringle. (Cambridge University Press), 1957. Pp. vii + 132. Price 15 sh.

During the course of evolution, Nature has several times attempted to solve the problem

of flight. The birds, bats and insects are notable achievements of these attempts, with a few lesser known examples. Of them again, the birds and insects are the two groups where mechanisms of flight have been developed to a high degree. Among the Aves the flight mechanisms are similar throughout the group while in *Insecta* they offer a great variety of structural and physiological modifications which makes flight in this group a truly amazing phenomenon. In comparison with the insect, the bird is ungainly, clumsy and crude, unable to execute the almost incredible feats of the former,—rapid starts, astonishing change of direction and even backward flight. If our knowledge of insect flight has not advanced as much as that of the birds, it is largely because of the small size of insects as well as the great variety and complexity of the mechanisms, which involve a number of extremely tiny structures disposed in intricate designs.

It is clear that the disciplines needed for the understanding and elucidation of insect flight are at once diverse and exacting, and it is not surprising that our knowledge of it is of recent development, gained during the past 10-15 years. All the others, like Magnan's book *Le Vol des Insectes* (1934), are of historical value. This is because much of the physics and mathematics of flight is itself of recent origin, and this knowledge has contributed measurably to a clearer and more competent appreciation of the variety as well as the intricacy of insect flight mechanisms. Consequently, the advances being made each year are so striking and spectacular that frequent reviews seem necessary.

J. W. S. Pringle's book is one such review, and a very competent one, bringing together most of our knowledge of the diverse problems associated with insect flight. Much of the general anatomy of the wings and wing-bearing segments is known for a long time from the classical studies of Snodgrass and others. But the kinematics, the relation between histology, physiology and biochemistry of flight muscles and aerodynamics are problems of the most absorbing interest and Dr Pringle has put together the available information, so as not only to indicate the progress made in these fields but also to present, in outline, the directions of future research. Specially important in this connection is the development in higher insects,—Diptera, Hymenoptera and Coleoptera,—of a peculiar type of flight muscle, the fibrillar muscle, which is responsible for the wonderful feats of high frequency movement in these insects, and the like of which is never met with anywhere else.

It has been possible to present here an analysis of the enzymatic activity, metabolic rate and oxygen consumption in this muscle, and all evidence points to its being a highly unique structure whose evolution in the group should be of absorbing interest.

A chapter on nervous and sensory mechanisms deals with the extent of our knowledge of the control of flight. Even here, the factors involved are so many and so diverse that we are only just beginning to understand some of them. For instance, there must be different sensory and nervous mechanisms for flight initiation and flight maintenance. In a number of insects, flight initiation is now known to be specific reflex action, the so-called "Tarsal reflex" of Fraenkel but the maintenance of flight is governed by an entirely different set of factors and stimuli one of which Weis-Fogh calls "wind on the moving wings". But it should be emphasised that neither flight initiation nor its maintenance is due to the same factors in all insects and it is quite possible that even here, an evolutionary trend could be discerned among them.

*Insect Flight* is invaluable to all students of entomology as well as those who are interested in the physiology and physics of movement in the air.

B. R. S.

#### A School Course of Biology. Fourth Edition.

By L. J. F. Brimble. (Publishers: Macmillan & Co., Ltd., London), 1957. Pp. xv + 558. Price 18 sh.

Mr. Brimble is well known for his many books on biology, social science and general education. *A School Course of Biology* is written to meet the requirements of candidates of General Certificate of Education (Ordinary Level) in Great Britain. For the Fourth Edition, the author has secured the collaboration of Dr. Kramer, a senior biology master, who is also "well known for his work in connexion with the teaching of biology and with its social applications".

The book contains 20 chapters: each chapter is followed by questions and very useful "suggestions for practical, observational, experimental and field work" for the student. The treatment of the subject is very simple and lucid. Many of the recent biological findings are incorporated in the text. Mention may be made of the simple autoradiograph on page 163. The last chapter, man in relation to other living organisms, is devoted towards the economic aspects of biology of everyday nature, such as,

food crops, beverages, medicines, textiles, timber and animals (for food, leather and drugs). It is very informative for the beginner. References are also made to insecticides, biological control of pests, microbiology, viruses and animal husbandry.

The statement on page 528 that among the algæ there are no parasites is erroneous, for it is known that *Rhodochytrium* and *Phylloisiphon* among Chlorophyceæ, and *Harveyella* and *Choreocolax* among Rhodophyceæ are undoubtedly parasites accompanied by loss of photosynthetic pigments. Cassava (p. 501) appears in italics and the student will mistake it for the Latin name, as the other Latin names in the same chapter are printed in italics. There is a printer's devil on page 36: it ought to be *mono-tremes* and not *mono-tremes*. On page 103, reference to the same page is superfluous. There is no uniformity with regard to the magnifications of figures. For some magnifications are given and for a majority of the others magnifications are not given. While the line drawings are effectively reproduced, half tones are not very clear, for the paper used is not suitable for fine reproduction of the latter.

Mr. Brimble must be congratulated for producing one of the best text-books of biology in the United Kingdom. The book is got up well with end papers depicting "evolution of organisms". The price is within the reach of the student. With slight elaboration of individual life-histories of plants the book may be recommended for pre-University course in biology in India.

R. NARAYANA.

#### Books Received

*The Invertebrata*. Third Edition. By G. A. Kerkut, L. A. Borradaile and F. A. Potts. (Cambridge University Press, London N.W. 1), 1958. Pp. xvii + 795. Price 55 sh.

*An Introduction to Statistics for the Social Science*. Second Edition. By T. G. Connolly and W. Sluckin. (Clever-Hume Press, London W. 8), 1957. Pp. vii + 166. Price 16 sh.

*Combination of Observations*. By W. M. Smart. (Cambridge University Press), 1958. Pp. xi + 253. Price 35 sh.

*Surface Active Agents and Detergents*, Vol. II. By A. M. Schwartz, J. W. Perry and Julian Berch. (Interscience Publishers, N.Y.), 1958. Pp. xv + 839. Price \$17.50.

*Film Formation, Film Properties and Film Deterioration*. By Charles R. Bragdon. (Interscience Publishers, N.Y.), 1958. Pp. xv + 422. Price \$9.75.

---

## SCIENCE NOTES AND NEWS

---

### Lobed Leaf-Mutant in Blackgram (*Phaseolus mungo*, Linn.)

Blackgram usually has large trifoliate leaves. Divakaran and Ramabhadran report an interesting deviation from the normal leaf character observed in blackgram grown under rain-fed conditions in the black soil block of Agricultural Research Station, Kovilpatti. One single plant, in selection No. 212 received from the Millets and Pulses Specialist, Coimbatore, was found to have three lobes instead of the normal trifoliate leaves. But for this peculiarity, the plant conformed to *Phaseolus mungo*, Linn., in description. Though occurrence of lobed leaf in greengram has been recorded it is not reported in blackgram. The inheritance and ontogeny of the character are being pursued.

### X-Ray Analysis of Rare Earths

The Bureau of Mines has developed a simple and accurate method for making quantitative analyses of rare earth ores, metals and compounds, using X-ray emission spectroscopy. With the new technique, 40 samples a day can be analysed for seven elements each, whereas, with the methods formerly used, only about a dozen samples could be analysed in a week.

The method is described in Bureau of Mines Report of Investigations R.I. 5378, "X-Ray Emission Spectrographic Analysis of Bastnaesite Rare Earths".

### Super Powerful Microscope

This is one of the new types of super powerful microscopes designed by Soviet scientists and engineers. They have a magnifying power of over one million.

The electronic projector resembles a television electronic tube. It has a glass retort with a spherical or flat bottom which serves as a screen.

Inside the retort is a fine metal needle directed towards the screen. The latter serves as the projector's negative electric pole. When a current of several thousand volts is passed through the needle, it emits electrons. Bombarding the screen, they produce on it a greatly magnified picture of the needle point and of the particles on it.

If a small quantity of gas is allowed to enter the retort, the molecules settle on the inner

walls and the needle. A molecule "sitting" on the needle is, so to speak, an additional protrusion which appears on the screen immensely magnified. No instrument has ever had such great magnifying power.

Metal surfaces can be observed and studied with the help of the new device. The scientist has to make only the needle of the required metal, and microscopes of one or even two million-fold magnifying power will make it possible for him to study the crystalline structure of the metal. The new instrument can be used to observe and study molecules of many substances such as, for instance, antroene, oxygen, etc.—*Soviet News*.

### Ultraviolet Color-Translating Microscope—New Tool for Studying Anatomy of Living Systems

This paper reports initial results with the ultraviolet color-translating microscope, a new instrument which uses a combination of sequential color television and ultraviolet microspectrophotometric techniques. A brief discussion of the operation is given (V. K. Zworykin and F. L. Hatke, *Science*, 126, 805, 1957). In the instrument the specimen is illuminated sequentially by three selected wavelengths in the ultraviolet or visible and the image reproduced on a color television receiver. The minimum bandwidth in the present instrument is  $5\mu$ , which permits the differentiation of small absorption shifts in the specimen. The ultraviolet dosage to the specimen is kept to a minimum by ultrafractioning the light into approximately 1-msec. bursts, 1/60 sec. apart. There is evidence to indicate that such intermittent illumination reduces radiation damage to the specimen. Previous methods of examining living tissue required photography or a continuous illumination using an ultraviolet-sensitive Vidicon. The reduced ultraviolet dosage using a special image Orthicon has permitted the continuous observation of such specimens as tissue cultures, muscle fibres, and connective tissues for periods which would previously have caused rapid necrosis and death.

In addition to color photographs of living unfixed specimens, motion pictures showing initial successful application to the study of amoeboid cells, Kupfer cells, capillary circulation, mast cells, and other elements in connective tissues in the mesentery, all in the living

state, are shown. Some suggestions for the development of improved optics were made.—*Science*, December 1957, p. 1237.

### Chemical Aeronomy

The chemical structure of the earth's atmosphere is primarily a result of the action of solar radiation on the atmospheric gases. The study of the chemical reactions between the various atmospheric constituents has been designated "chemical aeronomy", and the region of the atmosphere where these reactions are most prevalent is called the "chemosphere". Nitric oxide is present in the upper region of the chemosphere. Its concentration is determined by the relative rates of the reactions between atomic nitrogen and molecular oxygen and between atomic nitrogen and nitric oxide. Many of the aeronomic chemical reactions produce the luminous emission of the night airglow. The atomic lines and molecular bands of the airglow indicate, what chemical reactions are taking place and what are the physical conditions at the level of emission. The Herzberg and atmospheric bands of oxygen, which are prominent airglow emissions, have been produced and studied in Laboratory afterglows. Some still unidentified airglow emissions have also been obtained in Laboratory sources. The technique of artificially producing an airglow by rocket seeding experiments makes possible the detection of some of the atmospheric constituents and suggests as well, a method of measuring the temperature of the upper atmosphere.—*Science*, December 1957, p. 1232.

### Melting of Metals in a State of Contactless Suspension

A new high frequency installation to melt metal in a state of contactless suspension in a high frequency electromagnetic alternating field, without a crucible, has been designed at the high frequency electrothermic laboratory of the Metallurgy Institute, the USSR Academy of Sciences

The melting techniques used until now caused molten metal to combine with the material of the crucible. In the new installation metal is under the pressure of the electromagnetic field which counterbalances its weight. Transformed into a liquid, metal continues to "suspend" until it is poured out, absolutely free from foreign substances, into a mould.

The new melting method offers a possibility of studying such chemically active metals as zirconium, titanium, vanadium and their alloys.

The production of rare metals in a pure state

is important for the manufacture of modern technical equipment which has these metals as its ingredients.

### Particle Size Distribution by Centrifugal Sedimentation

Physical properties which may be used for characterization of thorium oxide are of special interest and must be determined. One of these properties which is related to the hydrodynamic behaviour of the slurries, is the size distribution of the particles.

Mr. Menis and colleagues of the Oak Ridge Laboratory, U.S.A., have developed a cumulative centrifugal sedimentation method applicable to determining the particle size distribution of thorium oxide in the particle size range of 0.1 to 2.0 microns in diameter. By selection of suitable operating conditions it is possible to accomplish sedimentation in small, cylindrical-shaped cells in 25 minutes or less. Under these selected conditions of sedimentation—detailed in report ORNL-2345—the particle size distribution can be obtained from the cumulative sedimentation data by applying either Oden's method of tangential intercepts or a function plot method. Results by this centrifugal method correlate with results obtained by different gravitational sedimentation methods for the portion of sample composed of particles greater than 2 microns in diameter.

### Antarctica is a Continent

Antarctica has always correctly been called a continent. This much has been shown by the preliminary results of the profile studies carried out by the Trans-Antarctic party under Dr. Fuchs: so far as that part of Antarctica covered by the party is concerned, the whole of the land beneath the ice cap is above sea-level.

The party made seismic and complementary gravimetric studies at frequent intervals along its 2,200 miles traverse. Until this scientific inquiry, it could not be taken for certain that Antarctica was continuous land. It could well have been series of islands cemented by its ice. From the recordings made, Mr. Geocrey Pratt is now able to say: "There is nothing below sea-level anywhere."

He said the continental profile studies showed, there were no mountains in the interior to compare with those in the McMurdo area. The mountain chains identified beneath the ice cap were "humps" by comparison. The general level of the underlying land on the McMurdo side of the Pole was much higher than on the

Weddell Sea side. One mountain system below the interior ice cap was only about 1,500 ft. under ice, Mr. Pratt said. Here the land was at 7,000 ft. making the surface 8,500 ft. This was the area about 50 miles south of Depot 700 where bad crevassing had been found. Crevasses in the interior usually sign posted mountain tops not far below.

Mr. Pratt spoke of the huge trough in the land beneath the ice of the South Pole. The shape of the continent, with huge "bites" opposite each other at the Ross and Weddell Seas, suggested that if anywhere there were a chasm below sea-level splitting Antarctica in two, it would be along this line. From the studies made by the crossing party this possibility may now be discounted.

Until the party reached the Pole, the seismic shots were made at about every 30 miles; beyond the Pole at about 60 miles. Gravimetric recordings were done about every 15 miles throughout.

#### Symposium on the Chemistry of Co-ordination Compounds

A Symposium on the Chemistry of Co-ordination Compounds will be held in December 1958, under the auspices of the National Academy of Sciences. The Symposium will be divided into the following sections: (1) General Survey; (2) Valence Bond Considerations, Stereochemistry and Structure; (3) Techniques and Methods of Investigation; (4) Reactions, Stability and Thermodynamic Considerations; (5) Stabilisation of Valence States; (6) Use in Analytical Chemistry; and (7) Applications.

Further particulars can be had from Arun K. Dey, Assistant Professor of Chemistry, University of Allahabad, Allahabad.

#### The Indian Society for Plant Physiology

The Inaugural Meeting of the Society was held on the 24th of January 1958, in the University of Allahabad, when the Constitution of the Society was adopted and the following Office-bearers for 1958 were elected: *President*: Prof. P. Parija, *Vice-Chancellor*, Utkal

University, Cuttack; *Vice-Presidents*: Shri Boshi Sen, Director, Vivekananda Laboratory, Almora; Prof. Shri Ranjan, *Vice-Chancellor*, Allahabad University, Allahabad; Dr. J. C. Sen-gupta, *Chief Botanist*, Botanical Survey of India, Calcutta; *Honorary Secretary*: Dr. J. J. Chinoy, *Reader in Botany*, University of Delhi, Delhi-8; *Honorary Treasurer*: Dr. K. K. Nanda, *Lecturer in Botany*, University of Delhi, Delhi-8.

#### Award of Research Degree

Messrs. B. T. Lingappa and Yamuna Lingappa were awarded the Ph.D. Degree by the Purdue University, Lafayette, Indiana, for their work on "Cytology of Development, Sexuality and Host Reactions of *Synchytrium Brownii* Karling and *Physoderma pulposum* (Wallr.) Karling respectively.

Messrs. V. Sundara Murthy, B. Radhakrishna Murthy, and Chengalvala Venkata Ratnam of the Osmania University, Hyderabad-Dn., were awarded the Ph.D. Degree in Chemistry for their theses entitled "Search for Physiologically Active Compounds: Synthesis of Some Halo and Nitro Coumarins"; "Studies on Groundnut-Shell Hemicelluloses" and "Studies in the Formation of Heterocyclic Rings from Ophenylene Diamines and Aromatic Aldehydes" respectively.

The Andhra University has awarded the D.Sc. Degree in Physics to the following candidates for their thesis indicated against each: Shri V. Suryanarayana, "Spectroscopic Investigations on Some Disubstituted Benzenes"; Shri S. L. N. G. Krishnamachari, "Calculation of Force Constants of Certain Polyatomic Molecules and Investigations on the Raman Effect, Infrared and Ultra-violet Absorption of Fluorinated Disubstituted Benzenes"; Shri P. B. V. Haranath, "Band Spectra of the Halogens ( $X_2$ ,  $X_2^+$ ,  $X_2^-$ )"; Shri Ch. Radhakrishnamurthy, "Studies in Dielectrics at Microwave and Radio Frequencies"; Shri K. V. Gopalakrishna, "Dipole Moment Calculations of Some Tetra Substituted Benzenes and Investigations on Dipole Moments and Relaxation Times at Microwave Frequencies".

442 58. Printed at The Bangalore Press, Bangalore City, by C. Vasudeva Rao, Superintendent, and Published by A. V. Telang, M.A., for the Current Science Association, Bangalore.

All material intended for publication and books for review should be addressed to the Editor, *Current Science*, Raman Research Institute, Bangalore-6.

Business correspondence, remittances, subscriptions, advertisements, exchange journals, etc., should be addressed to the Manager, Current Science Association, Raman Research Institute, Bangalore-6.

#### ANNUAL SUBSCRIPTION

India: Rs. 8-00.

Foreign: £ 0-16-0. \$ 2.50.



**OMEGA INSTRUMENTS CO.**  
**CALCUTTA**

*Manufacture—*

LABORATORY OVENS with thermostatic control of all sizes for various temperature ranges, with and without fan circulation.

THERMOSTATIC BATHS

NULL POINT DETECTOR

LABORATORY OSCILLATOR

LABORATORY CIRCULATION PUMPS

SERUM INSPISSATORS

INCUBATORS

PILOT PLANTS FOR INDUSTRY

*Please send enquiries to the Sole Selling Agents*

**KINLAB (PRIVATE) LTD.**  
**5, Marquis Street**  
**CALCUTTA 16**

**SPECTROSCOPIC EQUIPMENT**  
**AND**  
**ACCESSORIES**

**FOR**  
**QUANTITATIVE ANALYSIS & RESEARCH WORK**

Light sources like Arc Lamps with universal movements, precision slits, mountings for spectrographs, cameras, microphotometers, etc., etc.

*Entirely Our Manufacture*

*For full particulars, please write to :*

**THE GENERAL**  
**ENGINEERING AND SCIENTIFIC CO.**

**WALTAIR, VISAKHAPATNAM-3**

**(S. INDIA)**

**GRAMS: "ELECTRONIC"**

*Technical Adviser :*

**Dr. I. RAMAKRISHNA RAO**  
**M.A., Ph.D. (Cal.), D.Sc. (Lond.)**

**BALANCES**  
**FOR**  
**RESEARCH & ROUTINE WORK**

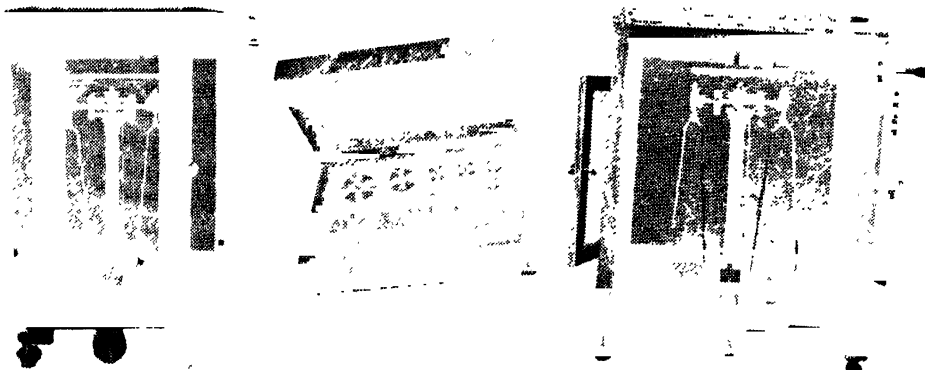

Catalogues sent on request

*Manufactured by :*

**SCIENTIFIC INDUSTRIES (India)**

**34, Banerji Bagan Lane, SALKIA (Howrah)**

## STUDY OF COSMIC RAYS WITH EARTH SATELLITES\*

**T**ILL last century science had but two sources from which it could obtain information on outer space, stars, nebulae and planets. The first source was light radiated by heavenly bodies, and the second was meteorites. They were the only heralds of outer space known to science, that came to Earth. Early in our century, scientists discovered that an endless stream of invisible and intangible rays was pouring down on the Earth from cosmic space, and they were called cosmic rays. It was established that these rays were fluxes of electrically-charged particles possessing very high energy. Later it was found that the rays discovered are not strictly speaking cosmic rays, but arise in the Earth's atmosphere under the action of particles which have really come from the interior of outer space and were called primary cosmic rays. Since the interaction of primary rays and atmospheric matter takes place at very great altitudes, scientists had to confine themselves for a long time to the study of secondary rays. These studies resulted in highly important discoveries in atomic physics.

The nature of the primary cosmic rays, their composition, that is the atomic particles of which they are composed, how they have been accelerated to tremendous energies, and, finally, where they originate, are of enormous interest for contemporary physics and astronomy. When the answer to these and many other questions relating to the nature of cosmic rays has been found, science will be able to throw light on a great many important problems of natural science required for an understanding of the processes taking place on the surface of stars and phenomena in interstellar space.

Study of the primary cosmic rays helps to solve too, a number of geophysical problems, such as the investigation of structure of the outer parts of our planet's magnetic field which are inaccessible to us.

However, to study the primary cosmic rays, experiments have to be conducted in the upper atmosphere. Until recently, these experiments were conducted by taking up recording instruments in balloons or rockets, but the achievements of Soviet science and engineering have made it possible to use an incomparably better

means for the purpose, namely, artificial Earth satellites.

The first study of cosmic rays under such conditions was made on Sputnik-2. Two particle counters installed on the Sputnik made it possible to measure the full flux of cosmic rays at various altitudes above the Earth and over different areas of our planet.

The main purpose of these experiments was to determine how the streams of rays differ from one another in different latitudes and how the stream changes in time, in other words, to study the so-called variations of cosmic-radiation intensity.

A study of the variations is very important for understanding the nature of these rays and flux of particles emitted by the Sun, streams, which serve as the original cause of magnetic storms on the Earth.

It should be mentioned that fluctuations in the number of particles in the flux are found also on the Earth's surface, but these are variations of secondary radiation, very often depending not on the changes in the stream of primary particles, but on meteorological conditions, that is, how dense the atmosphere is at a particular moment and hence also how many atoms happened to be in the way of the primary rays. Besides, primary particles possessing low energy (it is their number which is subject to the greatest fluctuations) produces practically no "offspring", that is, secondary rays which reach the Earth's surface.

What new data on cosmic rays have been obtained by means of the Sputnik?

It has been established that between the altitude of the order of 200 kilometres (Sputnik-2's lowest altitude above the Earth) and the altitude of 700 kilometres the intensity of the stream of primary cosmic particles increases roughly 40%, while measurements made earlier by means of balloons and rockets showed that from an altitude of 40 kilometres and higher the intensity remains approximately constant.

Is there any contradiction here or not?

The increased number of particles at high altitudes can be thoroughly explained. There are two reasons for it. The stream of cosmic rays comes to the Earth uniformly from all around. However, since particles which possess even the highest energies cannot penetrate the Earth, measurements near the surface

\* By I. Kurnosova and M. Fradkin of the Institute of Physical and Mathematical Sciences, U.S.S.R.

of the planet register only the rays which come from above. As the measuring instrument is taken up higher and higher, it leaves so to speak the globe's shadow, registering an ever larger part of the stream. Obviously, at a very considerable distance from the Earth, it will record a stream approximately twice as intense as on the surface. At an altitude of 700 kilometres 15% more particles pass through the instrument as a result of this phenomenon.

The remaining some 25% of the increase are due to the fact that the higher the altitude the lesser the Earth's magnetic field.

Charged particles, as we know, get deflected in their path in the presence of a magnetic field and the deflection is more when the energy of the particle is low and increases with the intensity of the magnetic field. In this sense the Earth's magnetic field can be compared to an armour. Particles possessing low energy are almost immediately thrown aside, and particles possessing higher energy penetrate deeper into it. Obviously the higher the instrument is taken up, the more particles should it register.

As a result of the experiments conducted on Sputnik-2 data were obtained on the distribution of particle flux above the Earth, that is, how the intensity of their flux depends on the latitude and longitude. This distribution too is the result of the interaction of the particles with the Earth's magnetic field. The field tends to deflect the incident particles in the direction of its poles. The existence of this phenomenon was obvious from theoretical reasons, and were corroborated experimentally.

The Sputnik, however, enabled us to get a somewhat different picture. Its counters showed that the particles are distributed by the magnetic field differently from what had been imagined earlier, and we may draw the conclusion that the Earth's magnetic field is responsible for it, as the structure of its upper regions is different from the way it was presented by the theory based on ground measurements.

The experiments on the distribution of the intensity of the cosmic rays over the whole globe conducted on Sputnik-2 are but the beginning of extensive studies of the structure of the Earth's magnetic field. Many careful measurements with the aid of sputniks will be required before the accumulated data permit us to make definite and reliable scientific deductions.

One of the assignments of the equipment on Sputnik-3 is to continue the study of the intensity of cosmic rays.

It was stated in the announcement on the launching of Sputnik-3 that it is equipped also with the instruments for registering the high-energy photons and heavy nuclei.

What is the purpose of these measurements? Scientists assume that the Sun, in addition to radiating intensive corpuscular streams and cosmic rays, from time to time emits waves akin to visible light but much shorter, or, as they say, hard electromagnetic radiation, also called high-energy photons or gamma quanta.

High-energy photons, like primary cosmic rays, do not penetrate the atmosphere all the way down to the surface of our planet, and scientists using ground equipment can therefore neither confirm nor deny this assumption with full assurance. Balloons and rockets are of no substantial help in solving this problem; it can be cleared up only by means of an artificial satellite.

Today it is evidently premature to say what the acceptance or rejection of this hypothesis will mean to science, but at any rate our concepts of the Sun and its activity will become more complete. If it is found that our luminary radiates high energy photons, a very alluring prospect may open up to astronomy, the prospect of studying heavenly bodies not only in the rays of visible light and with the aid of the radio waves recently "mastered" by astronomers, but also of using high-energy photons for their purposes.

Sputnik-3 will study still another problem relating to the physics of cosmic rays, namely, it will register the presence of heavy atomic nuclei in these rays.

It is very important for science, chiefly for astrophysics, to know what atomic nuclei go to compose the primary cosmic rays and the sort of nuclei they contain. Data on this could tell us a great deal about the origin of cosmic rays.

Only by getting the proper instrument up to a considerable altitude will we be able to get an answer to this question. We have already mentioned that on the whole all primary rays are absorbed in the upper layers of the atmosphere. It may be added that the heavier the nucleus the greater the probability of its being absorbed, and the shorter the path it travels in the atmosphere, and, hence, the higher must be the instrument to make it possible to register heavy nuclei.

For this purpose up to now science has had a more or less clear idea of the number of light nuclei which are a component part of cosmic streams. The "variety" of nuclei has been ascertained: it makes up roughly a quarter of Mendeleev's table of elements. So far

we have no information on the number of the heavier nuclei, but the studies by Sputnik-3 will enable us to throw light on this important problem too.

The launching of the third artificial Earth's

satellite equipped with instruments to conduct all-round studies of cosmic space will further the progress made by means of the first sputniks and will provide science with many new data.

## GEOCHEMICAL SURVEY TECHNIQUES

**G**EOCHEMICAL methods of mineral exploration are based on the premise that diagnostic disturbances in the normal distribution pattern of chemical elements may exist in accessible material in the vicinity of concealed ore deposits. Such geochemical anomalies result from the natural dispersion of elements from the site of the parent deposit and are commonly sought by the systematic sampling and analysis of rock, soil, vegetation, stream water and stream alluvium.

Geochemical dispersion patterns are subdivided into two genetic categories, namely, primary dispersions formed in depth at the time of mineralization, and secondary dispersions, which are usually formed in the zone of weathering. Primary dispersion patterns may occur as regional variations in the trace element content of rocks and minerals, associated with metallogenic provinces, aureoles of impregnation in the wall-rocks surrounding individual deposits, or 'leakage' dispersions of trace metals in the channel-ways followed by mineralizing solutions. In all cases, the primary dispersion is genetically related to the ore-forming processes. The interpretation of the geochemical anomalies in terms of the location of possible associated deposits is often difficult and is dependent on the understanding of the local geology. Secondary dispersions, on the other hand, are usually associated with the weathering cycle, and although the dispersion processes are complex, considerable progress has been made in the development and application of techniques having a proved practical value in prospecting. This is particularly true of geochemical soil surveys in areas of residual overburden, where the methods have been successfully used for detecting the presence of sub-outcropping deposits of copper, nickel, arsenic, gold, antimony, chromium, tin, tungsten, molybdenum and other metals.

At times, positive results have been obtained where copper, lead and zinc mineralizations have been concealed by transported glacial cover up to some tens of feet thick. Here, the metals have had the opportunity of migrating

upwards into the overlying material by diffusion and other processes, including the growth of vegetation which has extracted the ore metals as part of its nutrient uptake. Although the systematic analysis of the plants themselves has been employed on occasions, it is normally found more practicable to sample the underlying soil wherein metal has accumulated over generations, in the biogeochemical cycle. Geochemical soil and vegetation anomalies are usually restricted to the immediate vicinity of the parent mineral deposit, but abnormal concentrations of metal may sometimes be detected in the surface drainage system up to several miles downstream from mineralization. Where such geochemical dispersion does exist, the systematic sampling of stream-water or alluvium may constitute a useful aid in the rapid mineral reconnaissance of comparatively large areas. Sampling and analysis of stream alluvium for metals extractable at normal temperatures have given particularly encouraging results in reconnaissance for copper and base metal deposits.

The practical application of geochemical methods has been made possible only by the development of extremely rapid, simple tests and there are now trace analytical techniques for a wide range of metals capable of being performed with adequate accuracy by semi-skilled personnel. For the most part, these tests are simplified versions of classical colorimetric and chromatographic methods, although spectrographic, fluorimetric and other procedures may be utilized for particular problems.

Current research is active and aimed at broadening the scope of existing methods, extending knowledge of dispersion processes, investigating the regional approach to comprehensive geochemical reconnaissance and developing appropriate analytical techniques. Progress in the application of geochemical techniques indicates that, when used in conjunction with geological, geophysical and other sources of information, they will play an increasingly greater part in modern mineral exploration. (*Nature*, 181, 594, 1958.)

## CLAY MINERAL STUDIES

J. SHEARER

*Department of Physics, University of Western Australia, Nedlands, W.A.*

## GENERAL

CLAY is the term applied to material naturally occurring in a finely divided state in sediments and in soils, and exhibiting under suitable hydration the property of plasticity. The degree of hydration required for the material to be plastic occurs when the added water is in excess of the amount that can be adsorbed on the surface of the clay mineral particles with some definite configuration. Clay commonly comprises a mixture of one or more aluminium silicate minerals characterised, in general, by their layer structure, and a limited amount of foreign material comprising non-clay minerals and organic matter.

It is the occurrence in soils that is perhaps of special interest. Clay minerals commonly constitute the bulk of the colloid fraction of a soil and so they are of special importance to the soil scientist. They occur as products of the weathering process. The type of clay or clay mixture occurring in a soil depends on many factors, such as nature of the parent rock, climate and topography. Distribution in depth is an interesting study in relation to the weathering process for under ideal conditions of uniform climate over a sufficient period of time and favourable topography and drainage one may expect to find the weathering sequence extend from parent rock beneath to the most highly weathered product near the surface.

Of special interest in agriculture is the study of the occurrence and properties of clay minerals in relation to plant nutrition and soil fertilisation and to soil classification. These relationships are obscure with the result that the full significance of a mineralogical analysis in the case of a particular soil has still to be determined.

Clay minerals are important in many fields of technological interest. In the oil industry certain clays have important catalytic activity. They are also used as drilling muds. The stability of engineering structures depends on the physical properties of the supporting soil and these properties will depend on the prevalence and kind of clay present. In the foundry industry clays are used for molding purposes in association with molding sands. The import-

ance of clay mineralogy to the ceramic industry is obvious.

## STRUCTURE

Although the number of recognized clay minerals is large, the number of groups is relatively small. The structures characterising common groups will be described in this brief review.

The majority of clay minerals are layer structures and of these the majority belong to the ideal type of aluminium silicates, the remainder to the ideal type of magnesium silicates. Isomorphous replacement alters considerably the chemical nature of these two types. The two types may be described as follows:

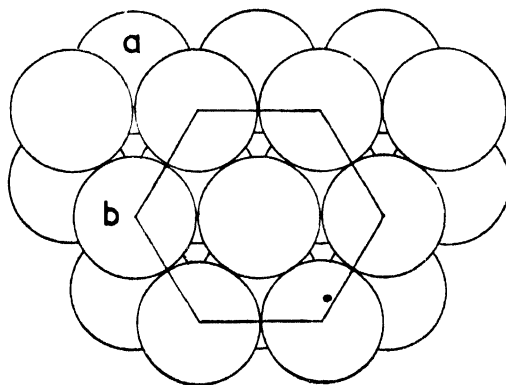

FIG. 1

Fig. 1 represents in plan two indefinitely extended sheets, parallel to the plane of the paper and one on top of the other, of close-packed OH ions. Ions like *b* are in the upper sheet. Ions like *a* are in the lower sheet. Mid-way between these two sheets, where gaps in the upper sheet overlie gaps in the lower sheet, are centres of octahedral co-ordination. For example ion *b* is one apex of an octahedron of which ion *a* is the other apex.

Just as there are the same number of OH ions in each of the two OH sheets so there are as many octahedral centres as there are ions in each of the two sheets.

In the ideal type of magnesium silicate clays the octahedral centres are occupied by Mg ions, giving  $Mg(OH)_2$ . In the other ideal type --  $Al(OH)_3$ —two-thirds of the octahedral centres

are occupied by Al ions. Since the ratio of occupied octahedral sites in the two ideal type is 3 : 2 they have been termed trioctahedral and dioctahedral respectively. In clay minerals, in spite of extensive replacement and variation from the ideal 3 : 2 ratio, the distinction between the two types tends to be preserved.

The silicate contribution to the two types is a tetrahedral layer made up as follows :

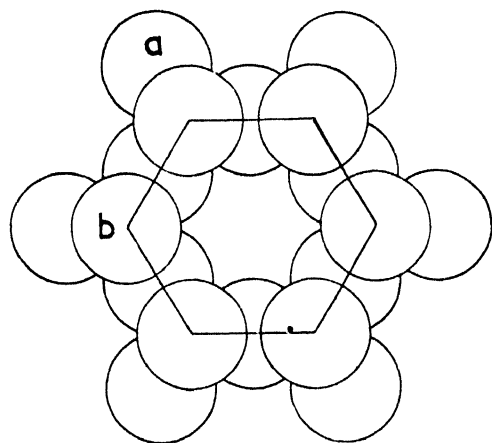

FIG. 2

Fig. 2 represents linked  $(SiO_4)^{4-}$  tetrahedra (Si not shown) indefinitely extended in all directions in the plane of the paper. The formula is  $(Si_2O_5)^{2-}$ . All O ions like b lie in a plane above that containing O ions like a. Each ion like b is the apex of a tetrahedron and directly beneath each such ion is a tetrahedral centre (not shown) occupied by a Si ion.

The first group of clay minerals belongs to the dioctahedral type. The octahedral and tetrahedral layers are combined as follows. In Fig. 1 the six OH ions in layer b occurring at the six vertices of the hexagon shown are replaced by the six O ions in layer b in Fig. 2. In the resulting composite structure indefinitely extended in 2 dimensions valency is satisfied and the formula is  $Al_2O_3 \cdot 2 SiO_2 \cdot 2 H_2O$ . This is the Kandite (or Kaolin) group, and the successive sheets of ions and the relative number of ions in each sheet may be represented thus :

3 O	
2 Si	Tetrahedral centres
2 O + OH	
2 Al	Octahedral centres
3 OH	
3 O	
.	
.	

There is a strong bond between the sheet of O ions and the adjacent sheet of OH ions. The different ways in which these two sheets are disposed in relation to one another differentiate the minerals within the kandite group. In halloysite a molecular sheet of water about 2.9 Å thick intrudes between sheets giving a basal spacing (perpendicular to the sheets) of 10.1 Å. The basal spacing of other members of the group and of the dehydrated form of halloysite (namely, metahalloysite) is about 7.1 Å. A very small cation exchange capacity observed for this group of clay minerals is attributed to broken bonds at surfaces.

Layer clay mineral structures other than the kandite group arise from a slightly more complicated way of combining octahedral and tetrahedral layers. Each of the two OH sheets of an octahedral layer may be modified to take a tetrahedral layer. The dioctahedral composite type may then be represented

3 O	
2 Si	Tetrahedral centres
2 O + OH	
2 Al	Octahedral centres
2 O + OH	
2 Si	Tetrahedral centres
3 O	
3 O	
.	
.	
.	

The bond O to O is a van der Waals bond. The trioctahedral type will have 3Mg replacing 2Al in octahedral centres. The two formulæ are  $Al_2O_3 \cdot 4 SiO_2 \cdot H_2O$  and  $3 MgO \cdot 4 SiO_2 \cdot H_2O$  respectively. Two non-clay minerals, pyrophyllite and talc, occur in nature with these ideal formulæ. By reference to these two minerals the structures of two more groups of clay minerals—clay micas and smectites (or montmorillonoids)—may be illustrated. Both arise from substitutional replacement accompanied by interlayer cations interrupting the van der Waal's bond.

In clay micas some of the Si is replaced by Al in tetrahedral centres, and the charge deficiency is balanced by interlayer K. Some randomness of stacking of adjacent layers occurs. On an external surface the K is exchangeable. Clay micas are usually dioctahedral like muscovite. In fact muscovite may be regarded as a highly crystalline form of clay mica with more Al in tetrahedral centres, more bound interlayer K and less  $H_2O$ ; hence arises the

term "hydrous micas" for all forms of clay micas. The basal spacing of clay micas is about 10 Å. Hydration accompanied by reversible expansion to 12 Å (perhaps 10 + 2·9) is sometimes observed. Clay micas with "fixed" basal spacing are termed illites.

In smectites the charge deficiency arising from substitutional replacement is balanced by interlayer cations that are exchangeable. The exchange capacity of these clays is therefore high. Water and other polar molecules also enter between layers. This process is reversible and so this clay group is characterised by high expansibility. When saturated with water, the basal spacing is about 15 Å. When dehydrated and collapsed by heating, it is about 10 Å as in mica. When treated with glycerol the basal spacing is 18 Å.

Two dioctahedral members of this clay group are montmorillonite and nontronite. In the former about 1 in 6 Al ions are replaced by Mg. Nontronite is characterised by a balanced substitution of Fe for Al in octahedral centres and a charge deficiency in tetrahedral centres arising from substitution of Al for Si. Saponite is a trioctahedral member with tetrahedral substitutions similar to those in nontronite.

Clay micas and collapsed smectites may both be regarded as being of mica type. One other clay group which is also a mica type is vermiculite. This is another expansible mineral with a basal spacing, when collapsed, of approximately 10 Å. When fully hydrated or treated with glycerol the basal spacing expands to 14 Å. It is basically a trioctahedral mica like biotite with charge deficiency arising from tetrahedral substitution of Al for Si. Interlayer cations (predominantly Mg) and interlayer water complete the structure. The cation exchange capacity is again high as in the case of smectites.

A fifth group of clay minerals which comprise a distinct type from the kaolinite group and the mica group is the chlorite group. This group is characterised by a fixed basal spacing, unaffected by heating, of 14 Å and a cation exchange capacity about the same as that for clay micas. Structurally it is trioctahedral like biotite with charge deficiency arising from tetrahedral substitution of Al for Si. But in this case the charge deficiency is balanced not by cations but by another trioctahedral layer with equivalent excess charge arising from replacement of Mg by Al in octahedral centres. Chlorite occurs in clays as well as in highly crystalline form, and is similar to vermiculite in this respect. The distinction may be similar to

that between clay micas and highly crystalline micas.

Apart from the five groups of layer structures above described, there is X-ray evidence for the occurrence of mixed layer structures with random interstratification of, for example, mica and montmorillonite. Finally there is a group of clay minerals showing chain or fibre structure instead of layer structure.

#### IDENTIFICATION AND ANALYSIS

We shall consider only the five groups of layer structures, and neglect mixed layer structures, chain structures, and mineral species within a group. The simplest technique is the X-ray powder diffraction technique with a camera capable of recording reflection from spacings up to at least 18 Å, supplemented by suitable hydration or solvation and heat treatment of the sample. Photographic recording is convenient. Advantage is taken of the plate-like character of all clay particles (except halloysite), and a powder sample is prepared with highly preferred orientation and mounted to give enhanced intensity of basal reflections. This preparation may be done in a number of simple ways.

Approximately pure samples may be identified as follows. Assume the sample has been treated with glycerol.

	1st order Basal Spacing	Basal Spacing after heat treatment at 600° C.
Kandite	7 Å	Destroyed
Mica	10 Å	10 Å
Smectite	18 Å	10 Å
Vermiculite	14 Å	10 Å
Chlorite	14 Å	14 Å

So that ideally the first order basal spacing of glycerol-treated "oriented" specimen is sufficient, except to distinguish vermiculite and chlorite. Then the heat treatment is essential, unless chemical methods (and they have been suggested) are adopted. The heat treatment is always desirable, particularly to avoid confusion between first order Kandite and second order vermiculite or chlorite.

When dealing with mixtures of clays heat treatment is essential. Quantitative analysis of such mixtures is difficult. Further evidence is sometimes then invoked provided by differen-

tial thermal analysis or chemical analysis. The accuracy is low so that the method of standard mixtures may be used even though it is impossible to rely on the identity of the standard mineral and the mineral in the unknown mixture. *Kandites* are much less susceptible to isomorphous replacement and can reasonably be assumed identical from standard to sample. The effect of composition on intensity may be considerable. For example, the intensities of 10 Å reflections of collapsed montmorillonite and collapsed nontronite, each with interlayer K, are theoretically in the ratio of 1:9.

One of the minerals present in a mixture may be used as an internal standard. This overcomes the difficulty of using an external standard, but other assumptions are inevitably involved that reduce the accuracy.

Finally a quantitative mineralogical analysis may be made from a qualitative X-ray mineralogical analysis in combination with a chemical

analysis for  $\text{SiO}_2$ ,  $\text{Al}_2\text{O}_3$ ,  $\text{MgO}$ ,  $\text{K}_2\text{O}$ , lattice  $\text{Fe}_2\text{O}_3$  (i.e., total  $\text{Fe}_2\text{O}_3$  less free  $\text{Fe}_2\text{O}_3$ ) and ignition loss at  $900^\circ\text{C}$ . If a mica is present the amount may be assessed from the amount of  $\text{K}_2\text{O}$ . If a smectite is present it may be assumed to be of composition intermediate between a pure Mg species (montmorillonite) and a pure Fe species (nontronite). The amount (and composition) of the smectite may be estimated from the amounts of  $\frac{1}{2}$  MgO (giving the amount of montmorillonite component) and of lattice  $\text{Fe}_2\text{O}_3$  (giving the amount of nontronite component). This procedure for a smectite neglects the possibility of the existence of a pure aluminum silicate smectite analogous to muscovite mica.

Each unknown clay mixture to be mineralogically analysed, must be treated as a separate problem, particularly because non-clay minerals involving Si, Al and Fe may also be present.

---

## THE TWISTOR

**A** NEW concept in memory devices has emerged from exploratory work by A. H. Bobeck at Bell Telephone Laboratories. This concept, which has been named the "Twistor", is expected to make possible, memory systems which are simpler to fabricate and more economical to manufacture than existing systems.

The "Twistor" concept opens the way for the construction of magnetic memory arrays by merely interweaving horizontal copper wires and vertical magnetic wires, in much the same way as a window screen is woven. Such a device would be similar in appearance to a ferrite core array, but without the cores, and would operate in much the same manner as a core array.

This new concept gets its name "Twistor" from a characteristic of wire made of magnetic material. Torsion, applied to such a wire shifts the preferred direction of magnetization from a longitudinal to a helical path. The coincidence of a circular and a longitudinal magnetic field can then be used to insert information into this wire in the form of a

polarized helical magnetization, and the magnetic wire itself can be used as a sensing means.

In practice, the circular magnetic field is provided by a current pulse through the magnetic wire, and the longitudinal field by a current pulse through the copper wire which is perpendicular to the magnetic wire. Thus, storing a bit requires two coincident current pulses. One pulse by itself is insufficient to store a bit. Readout is accomplished by overdriving the longitudinal field in the reverse direction. The readout signal is sensed across the magnetic wire. Because the lines of magnetic flux along the helical path wrap the magnetic conductor many times, a favourable increase in the output signal is obtained.

Present indications are that the drive circuits for a "Twistor" array can be readily transistorized. Thus, a memory system using the "Twistor" concept will retain all of the advantages of ferrite core or sheet systems, and will be much simpler and more economical to fabricate. (*Frank. Inst. Jour.*, Feb. 1958.)

---



## LEVELS OF ORGANISATION IN CELL FUNCTIONS

A. SREENIVASAN

*Department of Chemical Technology, University of Bombay*

IT is the most extraordinary phenomenon of nature that in the enzymatic events controlling life processes there is present a great deal of direction, order and co-ordination all of which show themselves by way of a harmonious and healthy existence. This order sets in right from cell division and multiplication. Thus, from the very beginning in the life of the fertilizing egg, the development of each tissue is co-ordinated with that of all others and this harmonious integration is apparently maintained by elaborate systems of physiological control throughout the life-span of the organism. The living form is thus an intricate and highly developed mosaic of varying and individually specific components.

For a fuller understanding of the basic chemical phenomena underlying this organisation, it has become incumbent to study isolated systems, away from the whole organism. In this process however there must be a clear recognition of the organisational features lost.<sup>1</sup> For, it is axiomatic in biology that the organism is more than the sum of the component tissue. An excised heart can be made to live outside the animal organism for several hours. Muscular contractions and relaxations can be observed with isolated muscle fibres for quite some time. Yet these components contribute more to the life processes that constitute the complicated morphological forms of complete animals.

Notwithstanding the arrangement and integration of parts at each level of complexity, a considerable amount of knowledge has accumulated through independent developments in the fields of enzyme chemistry and cytology. During the last two decades, chemical events in the body have been examined by a variety of means at the cellular and even sub-cellular levels. One of the first attempts in this direction has involved histological studies with tissue preparations. Even greater progress has been made on the dynamics of cellular processes through respiratory studies with tissue slices, homogenates and particulate fractions. This bold approach has paid excellent dividends and literally hundreds of different enzymatic mechanisms have been uncovered. An ever-increasing number of the finer reaction mechanisms that contribute to the sum total of metabolic processes are now explicable in terms of simple chemical equations. Such studies have for example enabled *in vitro* reconstruction of

the entire process of glycolysis by adding together some twenty different enzymes that include phosphatases, phosphorylases, kinases, enolases, isomerases, mutases and dehydrogenases. The synthesis of starch, glycogen, sucrose, etc., could now be accomplished by relatively simple model reconstructions. From studies on such isolated systems one could go into integrated pictures of larger areas of metabolism and physiologic behaviour.

## SUB-CELLULAR FRACTIONS

This concerted attack on the enzymic armoury of the plant and animal kingdom has revealed an unique architectural pattern or 'chemical geography' within the living cell itself. In other words, there is a beautiful though complex structural pattern in the cell which is equalled only by a similar complex chemical organisation. In fact, it could be argued that cellular architecture has evolved itself in such a way as to permit an orderly sequence of metabolic processes or spatial disposition of enzymatic units which excludes interference among the many biochemical reactions that occur simultaneously.<sup>2,3</sup> Thus, specific cellular structures have apparently specific chemical properties. Systematic procedures in cell fractionation techniques have been devised for the isolation of cytoplasmic elements by means of differential centrifugation in isotonic media of broken cell suspensions.<sup>4,5</sup> It is now well recognized that there are only limited numbers of particle types which are sharply distinguishable from one another by specific enzymatic properties and chemical characteristics.<sup>2</sup> Thus a heavy nuclear fraction with relatively less activity for most enzymes is followed by a grayish mitochondrial residue with a whole hodgepodge—but NOT a random hodgepodge—of enzymes and there is left a supernatant which could be further resolved at high speed into sub-microscopic microsomes and a soluble non-sedimentable fraction. The characterisation of the enzymatic and other properties of these sub-cellular fractions are now the subject of intensive study in different laboratories. The nuclei contain all the desoxy-ribose nucleic acid (DNA) of the cell and are responsible for the transmission of species characteristics. They are nearly devoid of oxidizing enzymes. Most of these and especially those concerned with the oxidation of the Krebs cycle intermediates re-

side in the mitochondria. On the other hand, the entire group of enzymes concerned with glycolysis are in the soluble phase. Thus, the breakdown of glucose into carbon dioxide would imply the participation sequentially of the enzymes in the supernatant and those in the mitochondria. It seems that at least with diphosphopyridino nucleotide (DPN) the enzyme system responsible for the synthesis of this coenzyme resides in the nucleus.<sup>6</sup> This would indicate a biochemical interaction between the nuclei and the cytoplasmic contents. Doubtless there are other similar such relationships.

#### MITOCHONDRIA

Numerous recent reports have concerned themselves with the properties of the mitochondrial bodies. They are found in all types of animal cells as well as in other forms of plant and microbial life. They have however been studied more extensively in the animal cells.<sup>3</sup> To the cytoenzymologists, they are always the characteristic landmarks in the intracellular landscape and represent the physical housing for a complex of enzymes, a kind of 'chemical microkitchen'. Among these enzymes are those responsible for the oxidation of the Krebs intermediates, fatty acids and certain amino acids.<sup>7,8</sup> While it is possible for any one enzymatic process to be isolated for purposes of study from the other processes catalysed by this complex, none of the enzymes can be separated from the others in the complex except by rather drastic means. Enzymes show varying tendencies to be detached from the mitochondrial bodies.<sup>9</sup> A whole spectrum of split products intermediate between the mitochondrion and soluble protein can be covered by the application of various devices for fragmenting and disintegrating mitochondria. In such manipulations probing into the mitochondrion, there is again considerable loss of organisational features.

#### OXIDATIVE PHOSPHORYLATION

Of special significance in this connection is the fact that the mitochondrion is also the seat of all oxidative phosphorylation.<sup>8,10</sup> In the oxidation of the substrates of the citric acid cycle by the mitochondrial enzymes, the need is felt for addition of inorganic phosphate, adenosine-5-phosphoric acid (AMP) or, more strictly, adenosine-diphosphate (ADP) and  $Mg^{++}$ .<sup>7,11,12</sup> Otherwise, oxidation slows down after a while. In the unfractionated tissue homogenate representing the entire cellular material, no such additions are observed to be necessary. This

will therefore denote a lower degree of organisation in the mitochondria as compared to the cell. The fact is, oxidations in the cell are coupled with simultaneous initiation of various endergonic reactions. This problem of energy transmission is fundamental to our understanding of the chemistry of the cell. If the two processes can occur in close juxtaposition at the respective enzyme surfaces the possibility of the dissipation of energy produced in the reaction as heat is reduced enormously. The oxidative processes thus enable the cell to do osmotic work, mechanical work such as contraction, ciliary movement and chemical synthesis. Unexpended energy of oxidation is stored as adenosine triphosphate (ATP) and phosphocreatine.

In a purified mitochondrial system, an oxidative process does not proceed unless there is an acceptor of the high energy bond ( $\sim$ ) which could be formed as follows<sup>7</sup>:



1. Substrate + oxidase  $\rightarrow$  Oxidized substrate  $\sim$  reduced oxidase.
2. Oxidized substrate  $\sim$  reduced oxidase + phosphate  $\rightarrow$  Phosphate  $\sim$  reduced oxidase + oxidized substrate.
3. Phosphate  $\sim$  reduced oxidase + ADP  $\rightarrow$  reduced oxidase + ATP.

According to this concept, phosphate is not necessary for the primary reaction. However, in its absence, the primary complex is stabilised and the over-all reaction velocity becomes limited by the spontaneous rate of breakdown of this complex. Like AMP or ADP, various energy-requiring systems could be equally well coupled with the oxidation. Thus, glucose and hexokinase (not present in mitochondria) or creatine and creatine phosphophenylase or thiamine and carboxylase can be added. They are referred to as trapping systems for the  $\sim PO_4$ . Alternately, adenosine triphosphatase (ATPase) can be added. The respiration of mitochondrial preparations is enhanced by additions of nuclei or supernatant preparations because of their contributions of ATPase or of endergonic systems.<sup>11</sup> ATPase functions by breaking down the  $\sim PO_4$ . Other uncoupling agents that could act at this step and thus promote oxidation without esterification of inorganic  $PO_4$  are dinitrophenol, atabrine, certain antibiotics, thyroxine, barbiturates, and so on. There is a suggestion that there may be fundamental differences in the mechanism by which various agents uncouple oxidative phosphorylation in mitochondria.<sup>13</sup>

Thus, in addition to the organized chain of carrier enzymes which transfer electrons from substrate to oxygen, the mitochondria possess the auxiliary enzyme system which couple phosphorylation of ADP to the exergonic electron transport process. The number of phosphate molecules esterified per mole of substrate oxidized in a single two-electron step, usually expressed as the P/O quotient (disappearance of inorganic phosphate:Oxygen uptake) is approximately three<sup>12,13</sup> and corresponds to a thermodynamic efficiency of some 60-70%.<sup>10</sup> Two of these coupled phosphorylation mechanisms are located between reduced DPN (DPNH) and cytochrome C and the third between cytochrome C and oxygen.<sup>11,15</sup>

#### MITOCHONDRIAL STRUCTURE AND FUNCTION

The most important property of the mitochondrial bodies resides in their efficient use of oxidisable substrates. The morphological and physical properties of mitochondria have attracted special attention because they are closely interlinked with mitochondrial functions. The mitochondria in living cells appear under an electron microscope like beaded rodlets enveloped by a membrane having an inner and an outer zone.<sup>3,9</sup> The presence of this membrane and its importance have been repeatedly brought out from various biochemical studies. When isolated freshly in hypertonic sucrose, a large number of these particles retain their original rod-like structure although a good per cent. of spherical forms are also present. The transformation to spherical shapes is complete on further dilution of the suspending medium.<sup>9</sup> The morphological alteration from elongated to spherical shape at isotonic concentrations however is not accompanied by any major changes in the biochemical properties of the mitochondria. Preparations with isotonic sucrose are widely used for various studies and represent the choicest material for study of oxidative phosphorylation. Actively metabolising mitochondria control the transport of solute and water across their membranes<sup>16</sup> and are known to concentrate to a small but significant extent certain ions, Krebs intermediates, etc.<sup>17,18</sup> This selective power of mitochondria which is energy-dependent is efficiently geared to the systems participating in electron transport and phosphorylation and points to the active and semipermeable nature of the surrounding membrane.

However it has become apparent during studies on oxidative phosphorylation that the mitochondrial membrane has a limited ability to carry out these functions and to maintain

the integrity of mitochondrial structure and its activities. Kielley and Kielley<sup>19</sup> found that the synthesis of ATP was rendered 'inoperative' by any procedure resulting in structural damage to mitochondria. A number of factors are known to cause a swelling of these particles due to imbibition of water. Exposure to hypotonic conditions, ageing, presence of traces of heavy metal ions or certain anions, other environmental alterations and physiological states result in an acceleration of swelling of mitochondria which may finally lead to their disintegration into smaller particles.<sup>16,20</sup> Mitochondria in intact cells have also been shown to be sensitive to such changes.<sup>21</sup> Among the biochemical alterations observed are the loss of several intramitochondrial components such as nucleotides and other co-factors, certain ions involved in oxidative phosphorylation and small quantities of soluble proteins.<sup>20</sup> Inhibition of certain enzymes and an activation of others which are latent in fresh mitochondria, especially of ATPase,<sup>19,27,30</sup> and an extreme lability of oxidative phosphorylation system in homogenates and mitochondria<sup>19,21,26</sup> have been consistently reported.

Several attempts at prevention of the swelling of the mitochondria as well as restoration of oxidative phosphorylation, by returning the component(s) presumed to be lost once the swelling had taken place, have met only with partial success.<sup>17,18,31</sup> Protection by adenine nucleotides and Mg<sup>++</sup><sup>5,26,32,33</sup> had been observed. Similarly addition of DPN has reportedly some effect.<sup>25</sup> Nearly complete restoration on addition of trichloroacetic acid extracts of fresh mitochondria has also been observed to occur.<sup>32</sup>

It seems evident that the swelling of mitochondria precedes rather than follows the uncoupling phenomenon. Little is known about the events which lead to the swelling of these particles under unfavourable conditions nor about the mechanisms by which phosphorylation is restored on addition of mitochondrial extracts or components. The concept that a supply of ATP is essential at all times for maintenance of mitochondrial integrity is probably not satisfactory.<sup>34</sup> It has been suggested that the swelling of mitochondria is probably an enzymic process rather than a disappearance of any protecting mechanisms.<sup>35</sup> Thus lysolecithinase from snake venom could act on mitochondrial phospholipids (in which it is rich) to give rise to lysolecithin which attracts water molecules with subsequent distortion, swelling, and even rupture of the membrane. However, the pre-

sence of lysolecithinase in mitochondria remains to be demonstrated. Again it has been observed that the swelling is more rapid under aerobic conditions and there is the possibility that oxygen reacts directly with a certain key group probably sulphhydryl.<sup>31</sup> Thus, in contrast to the slow and relatively limited swelling produced by other methods, sulphhydryl binding agents produce a rapid and more pronounced swelling, suggesting the participation of free sulphhydryl groups in the maintenance of mitochondrial structure and/or permeability.<sup>36</sup>

Particulate but no longer mitochondrial systems capable of catalysing phosphorylation during the oxidation of selected substrates have recently been obtained by Lehninger *et al.*<sup>37</sup> by digitonin extraction of rat liver mitochondria and by Green *et al.*<sup>38</sup> by fragmentation of beef heart mitochondria and fractional separation in presence of ethanol and phosphate. Although therefore it seems possible to obtain functional and structural, sub-units of the parent mitochondrion, the question as to whether these particles capable of both oxidation and phosphorylation are vesicular or solid cannot be definitely answered at the present time.<sup>39</sup> The fact that they do bind  $K^+$  like the intact mitochondria<sup>40</sup> would suggest a re-evaluation of the role of the mitochondrial membrane.

Despite recent achievements on the isolation of sub-cellular electron transport particles it would seem necessary to concede to the importance of mitochondrial integrity for the maintenance of oxidative phosphorylation and therefore of normal cellular metabolism. An expendable structural feature of an enzyme housing in an *in vitro* system may not be so in the complex milieu of the living cell. In a consideration of protein structure to function, Steinberg and Mihalyi<sup>1</sup> point out that "non-essential" features of enzymes and other biologically essential molecules may arise from their role in orienting the active protein to other structural features and enzymes in the cell. They may also determine its thermodynamic efficiency in the cell under different physiological conditions.

#### VITAMIN B<sub>12</sub> AND OXIDATIVE METABOLISM

Subtle changes in the geometrical organization of the multi-enzyme arrays and the matrix in which these functionally interdependent units are housed are conceivable under different biological conditions and hence intracellular control of oxidative phosphorylation may occur at any one of several sites in the coupling processes susceptible to interference. Indeed, it is

now recognized that uncoupling of oxidative phosphorylation could arise out of diverse known and unknown modalities.<sup>13</sup>

A reference may now be made to certain suggestions implicating vitamin B<sub>12</sub>, albeit indirectly, in the control of mitochondrial morphology. The observations have arisen from studies on protection afforded by this vitamin against experimentally induced thyrotoxicosis or liver injury.

When small quantities of an iodo-protein are included in the diet of experimental animals or when small doses of thyroxine are given to them parenterally, they show increased requirement for several of the food factors—among them, chiefly, B vitamins. This is a recognized procedure for induction of deficiency in certain of the B vitamins, the others being given in excess. Of especial significance is the increased requirement for vitamin B<sub>12</sub>. In thyrotoxic rats, there is usually a rapid weight loss and when this comes to about 10% the animals rapidly die off.<sup>42</sup> If excess B<sub>12</sub> is present in the diet, there is protection against weight loss and mortality.<sup>43</sup>

Again, a single injection of the steatotic poison carbon tetrachloride can cause fatty liver in the rat. This degeneration is also protected against by prior administration of vitamin B<sub>12</sub>.<sup>44</sup>

Uncoupling of oxidative phosphorylation has been reported in experimentally induced hyperthyroidism<sup>42,45,46</sup> as well as in steatotic liver injury.<sup>47</sup> Mitochondrial preparations from such livers show a good parallel in their behaviour and characteristics with normal mitochondria subjected to hypotonic conditions. They have lowered pyridine<sup>45,48</sup> and adenine<sup>49</sup> nucleotide levels, and exhibit decreased oxygen consumption<sup>50,51</sup> and lowered P/O ratios.<sup>45,47</sup> No effect of CCl<sub>4</sub> could be seen on mitochondrial integrity in *in vitro* studies.<sup>47</sup> Though *in vitro* uncoupling of oxidative phosphorylation by thyroxine has been reported,<sup>52-55</sup> this is not observed to take place in mitochondria held in isotonic sucrose.<sup>49</sup> Thus, thyroxine is effective *in vitro* only when the hormone is pre-incubated with mitochondria<sup>56</sup> or when the mitochondria are subject to hypotonic conditions<sup>57</sup> in its presence so as to facilitate entry of the hormone. Thyroxine acts by binding  $Mg^{++}$  once it enters the mitochondria<sup>58,59</sup> and thyroxine-induced uncoupling could be reversed by  $Mg^{++}$ . Thyroxine also fails to uncouple oxidative phosphorylation<sup>60</sup> in digitonin preparations<sup>37</sup> of mitochondria. These results are therefore suggestive of the fact that any *in*

*vitro* effect of thyroxine is not due to direct interference with the enzymes of oxidative phosphorylation and that its effect as well as that of  $\text{CCl}_4$  *in vivo* could arise from an impairment of mitochondrial integrity due to osmotic damage. This phenomenon obviously underlies the observed uncoupling of phosphorylation from respiration.

In recent work from this laboratory,<sup>61,62,44,63</sup> it has been demonstrated that, in experimentally induced nutritional stress such as thyroprotein feeding or  $\text{CCl}_4$  poisoning, there is depletion of tissue vitamin  $\text{B}_{12}$  levels and an impairment of several metabolic processes. A disturbance in glutathione metabolism and of osmotic damage to mitochondria precede all other derangements. A rapid reduction in liver stores of glutathione in the  $\text{CCl}_4$ -poisoned rat has also been reported by Patwardhan and co-workers.<sup>64</sup> Tapley and Cooper<sup>36,65</sup> observed that the action of thyroxine *in vitro* is probably due to its primary action on mitochondrial structure. Dianzani has made similar observations in steatotic rats.<sup>47,48</sup> Since oxidative phosphorylation is the only major pathway linking energy-requiring with energy-yielding processes, it is obvious that the uncoupling produced by mitochondrial swelling is reflected as metabolic derangements.

It has been suggested that the nucleotides are bound to sites in the mitochondria which are probably also the ones at which oxidative phosphorylation takes place. It would appear that the immobilisation of co-factors like AMP, ADP, DPN,  $\text{Mg}^{++}$ , etc., from their site of activity makes them unavailable for participation in oxidative phosphorylation. It is also possible that the nucleotides are bound to proteins enzymatically active and confer stability on these enzymes and that unbinding and subsequent loss of these from mitochondria makes the proteins more labile and enzymatically inactive.

The morphological and metabolic derangements of hyperthyroidism and fatty infiltration are all protected against by vitamin  $\text{B}_{12}$  *in vivo*.<sup>61,44,63</sup> An interesting feature relates to changes in pyridinonucleotides (PN). A marked reduction in PN and a decrease in PN/PNH (oxidised to reduced pyridinonucleotides) in  $\text{CCl}_4$  toxicity suggests a shift of fatty acid metabolism towards synthesis. PN is important because it is concerned in oxidation of fatty acids and in at least 3 steps in the citric acid cycle (isocitric,  $\alpha$ -ketoglutaric and malic dehydrogenations) whose normal functioning is necessary for fatty acid oxidation. The influence of vita-

min  $\text{B}_{12}$  on correction of  $\text{CCl}_4$  damage is explicable in terms of its favourable effect on PN and PN/PNH.<sup>66</sup>

Since mitochondria are apparently protected against changes attendant on swelling by AMP or ATP,<sup>25,26</sup> DPN<sup>25</sup> and sulphhydryl,<sup>34,36</sup> the protection observed with vitamin  $\text{B}_{12}$  might arise from its known role in nucleotide and sulphhydryl metabolism. Obviously the diverse effects observed with this vitamin, in extremely small amounts, on the physiology of the animal organism must arise from a very basic function it has in cellular integrity and economy.

1. Szent-Gyorgyi, A., *Chemistry of Muscular Contraction*, 2nd Edn., Acad. Press, 1951.
2. Hogeboom, G. H., Schneider, W. C. and Striebich, M. J., *Cancer Res.*, 1953, **13**, 617.
3. Palade, G. E., in O. H. Gaebler's, *Enzymes: Units of Biological Structure and Function*, Acad. Press, 1956, 185.
4. Claude, A., *The Harvey Lectures*, 1947-48, **43**, 121.
5. Holter, H., *Adv. Enzym.*, 1952, **13**, 1.
6. Hogeboom, G. H. and Schneider, W. C., *J. Biol. Chem.*, 1952, **197**, 611.
7. Green, D. E., *Biol. Revs.*, 1951, **26**, 410.
8. —, *J. Cell. & Comp. Physiol.*, 1952, **39**, Suppl. 2, 75.
9. Farman, J., *Expt. Cell. Res.*, 1950, **1**, 382, 394.
10. Lehninger, A. L., *Harvey Lectures*, 1953-54, **49**, 176.
11. Lardy, H. A. and Wellman, H., *J. Biol. Chem.*, 1952, **195**, 215.
12. Maley, G. F. and Plaut, G. W. E., *Ibid.*, 1954, **205**, 297.
13. Lehninger, in Gaebler (ref. 3), p. 217.
14. Nielson, S. O. and Lehninger, A. L., *J. Biol. Chem.*, 1955, **215**, 555.
15. Borlstrom, B., Sudduth, H. C. and Lehninger, A. L., *Ibid.*, 1955, **215**, 571.
16. Berthet, J., Berthet, L., Applemans, F. and de Duve, C., *Biochem. J.*, 1951, **50**, 182.
17. Bartley, W. and Davies, R., *Ibid.*, 1954, **57**, 37.
18. McFarlane, M. B. and Spencer, A. G., *Ibid.*, 1953, **54**, 569.
19. Kielley, W. W. and Kielley, R. K., *J. Biol. Chem.*, 1951, **191**, 485.
20. Harman, J. W. and Feigelson, M., *Exp. Cell. Res.*, 1952, **3**, 509.
21. Dianzani, M. U., *Biochem. et Biophys. Acta*, 1953, **11**, 353.
22. Schneider, W. C., *J. Histochem. and Cytochem.*, 1953, **1**, 188.
23. Chappell, J. B., and Graville, G. D., *Nature*, 1954, **174**, 930.
24. Tedeschi, H. and Harris, D. L., *Arch. Biochem. Biophys.*, 1955, **58**, 52.
25. Hunter, F. E. and Ford, L., *J. Biol. Chem.*, 1955, **216**, 357.
26. Siekevitz, P. and Potter, V. R., *Ibid.*, 1955, **215**, 221, 237.
27. Schneider, W. C. and Hogeboom, G. H., *Ibid.*, 1952, **195**, 161.
28. Lardy, H. A. and Wellman, H., *Ibid.*, 1953, **201**, 357.
29. Potter, V. R. and Siekevitz, P., *Ibid.*, 1953, **205**, 897.

30. de Duve, C., Presman, B. C., Gionetto, R., Wittiaux, R. and Applemans, F., *Biochem. J.*, 1955, **60**, 604.
31. Price, C. A., Fonnesu, A. and Davies, R. E., *Ibid.*, 1956, **64**, 754, 769.
32. Dianzani, M. U., *Biochem. et Biophys. Acta*, 1956, **22**, 389.
33. Ernster, L. and Low, H., *Exptl. Cell. Res.*, 1955, **3**, 133.
34. Hunter, F. E., Davis, J. and Carlat, L., *Biochim. et Biophys. Acta*, 1956, **20**, 237.
35. Witter, R. F. and Cottone, M. A., *Ibid.*, 1956, **22**, 364, 373.
36. Tapley, D. F. and Cooper, C., *J. Biol. Chem.*, 1956, **222**, 341.
37. Cooper, C., Devlin, T. M. and Lehninger, A. L., *Ibid.*, 1956, **219**, 489, 507, 519.
38. Green, D. E., in Gaebler (ref. 3), p. 465.
39. Watson, M. L. and Siekevitz P., *J. Biophys. & Biochem. cyt.*, 1956, **2**, 639, *Biochim. et Biophys. Acta*, 1957, **25**, 275.
40. Gamble, J. L., *J. Biol. Chem.*, 1957, **228**, 955.
41. Steinberg, D. and Mihalji, E., *Ann. Revs. Biochem.*, 1957, **26**, 373.
42. du Toit, C. H., in W. D. McElroy and B. Glass, *Phosphorus Metabolism*, Johns Hopkins Press, 1952, **2**, 597.
43. Fatterpaker, P., Marfatia, U. and Sreenivasan, A., *Nature*, 1951, **167**, 1067.
44. Kosbekar, D. K., Rege, Q. V. and Sreenivasan, A., *Ibid.*, 1956, **178**, 989.
45. Maley, G. F. and Lardy, H. A., *J. Biol. Chem.*, 1955, **215**, 377.
46. Maley, G. F., *Ibid.*, 1957, **224**, 1029.
47. Dianzani, M. U., *Biochim. et Biophys. Acta*, 1954, **14**, 514.
48. Dianzani, M. U., *Biochim. et Biophys. Acta*, 1955, **17**, 391.
49. —, *Biochem. J.*, 1957, **65**, 116.
50. Chernick, S. S., Moe, J. G., Rodnan, G. P. and Schwartz, K., *J. Biol. Chem.*, 1955, **217**, 829.
51. Dianzani, M. U., *G. Biochimica*, 1953, **2**, 180.
52. Martius, C. and Hess, B., *Biochem. Z.*, 1955, **326**, 191.
53. Hoch, F. L. and Lipman, F., *Proc. Nat. Acad. Sci.*, 1954, **40**, 909.
54. Maley, G. F. and Lardy, H. A., *J. Biol. Chem.*, 1953, **204**, 435.
55. Klemperer, H. G., *Biochem. J.*, 1955, **60**, 122.
56. Martius, C. and Hess, B., *Arch. Biochem. Biophys.*, 1951, **33**, 486.
57. Tapley, D. F., Cooper, C. and Lehninger, A. L., *Biochim. et Biophys. Acta*, 1955, **18**, 597.
58. Bain, G. A., *J. Pharmacol. Exptl. Therap.*, 1954, **110**, 2.
59. Achitt, J. and Alebin, L., *Biochem. Z.*, 1953, **324**, 364.
60. Cooper, C., Devlin, T. M. and Lehninger, A. L., *Biochim. et Biophys. Acta*, 1955, **18**, 159.
61. Fatterpaker, P., Marfatia, U. and Sreenivasan, A., *Nature*, 1955, **176**, 165.
62. Lavate, W. V. and Sreenivasan, A., *Ibid.*, 1956, **178**, 804.
63. Kasbekar, D. K. and Sreenivasan, A., *Ibid.*, 1956, **178**, 990.
64. Patwardhan, M. V., Ramalingaswami, V., Sriramachari, S. and Patwardhan, V. N., *Ind. Jour. Med. Sci.*, 1953, **7**, 553.
65. Tapley, D. F. and Cooper, C., *J. Biol. Chem.*, 1956, **222**, 325.
66. Nadkarni, G. B. and Sreenivasan, A., *Nature*, 1957, **180**, 659.

## FREE RADICALS IN CIGARETTE SMOKE

IN attempts to determine a unifying principle of action for the many and varied carcinogenic agents, many workers have assigned an intermediary role to free radicals. It is stated that many, if not all, carcinogens are compounds capable of forming free radicals which may be stabilized as ions. Scientific workers have discussed their possible role in the production of tumours in rodents by implanted films of various high polymers, and suggested, as a requirement for tumour production, the presence of foreign free radicals in a specific area for an extended period.

Primary consideration is normally given to aromatic polycyclic hydrocarbons as active agents in tobacco carcinogenesis. However, in view of the above, it seemed of interest to determine the concentration of free radicals in cigarette smoke. A series of experiments, which utilized a high-sensitivity electron resonance

spectrometer, have therefore been carried out. In order to prevent recombination of radicals as much as possible, the smoke was condensed at liquid-oxygen temperatures, and all measurements were made at this temperature.

The combined evidence from these experiments suggested that there is sufficient concentration of free radicals in cigarette smoke (when compared with the expected concentrations in the polymer experiments) to act as a carcinogenic agent if such a mechanism is possible. It is interesting to note in this connexion that the concentration of stable free radicals in atmospheric soot is about one hundred times larger than in cigarette smoke. But, as with the polycyclic hydrocarbons, adsorption on comparatively larger particles, and further stabilization as a result, are likely to render them inaccessible to the cells. (*Nature*, April 5, 1958.)

## LETTERS TO THE EDITOR

LIPID DEPLETED ADRENAL CORTEX  
IN MOLYBDENUM FED RATS AND  
ITS PREVENTION BY VITAMIN E

AN interrelationship between vitamin E and molybdenum has been observed in prolonged studies conducted on the action of this metal.<sup>1,2</sup> Certain enzyme systems, like alkaline phosphatase are enhanced, in livers of molybdenum-treated experimental animals and vitamin E is used to prevent this rise.<sup>3</sup> Vitamin E deficiency causes degenerative changes in the suprarenal cortex.<sup>4</sup> Likewise, administration of vitamin E has a stimulating effect on suprarenal activity.<sup>5</sup> In the present report, the histological structure of the suprarenal cortex of albino rats on a molybdenum, and molybdenum *plus* vitamin E dietary have been studied and compared with that of control experimental animals.

Young weanling albino rats were maintained on a standard casein diet. They were divided into three groups: one served as control, the second received a molybdenum fortified diet at a level of 100 p.p.m., and the third received the same diet as group two, with an additional supplement of vitamin E orally, 8 mg. per week. After maintaining for 6 months, the animals were sacrificed by cardiac bleeding. The adrenals were fixed in 10% formol and processed by the usual methods.

Fig. 1 represents the microanatomical structure of the suprarenal cortex under high

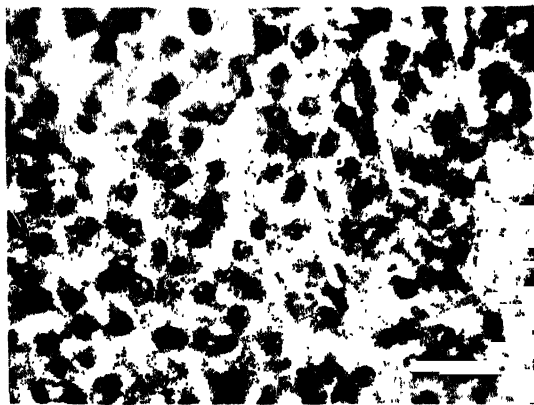

FIG. 1 a.

power. Fig. 1 a represents the normal lipid pattern in a typical adrenal cortex from a

normal control animal. It can be noticed that the spaces are filled with lipid material. Fig. 1 b is from a representative animal on the molyb-

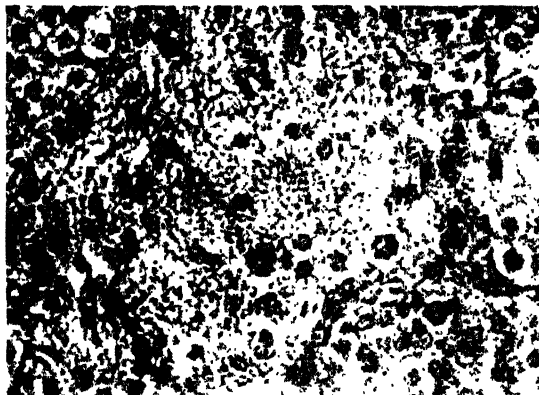

FIG. 1 b.

denum dietary. The histological picture indicates a necrosis with lipid depletion. Fig. 1 c

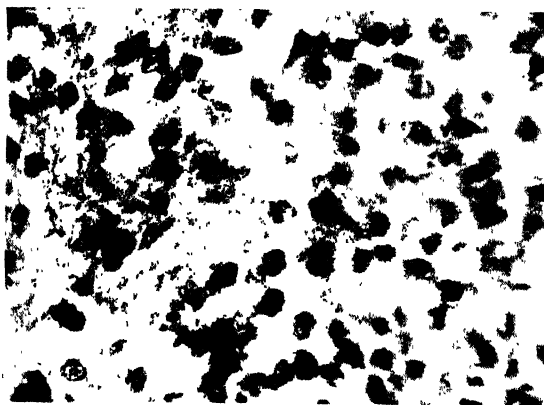

FIG. 1 c.

represents the effect of vitamin E on a molybdenum dietary as reflected by a return to normal of the lipid pattern. The effect of vitamin E is markedly pronounced, totally masking the effect of molybdenum.

The evidence presented here indicates that molybdenum suppresses suprarenal cortical function, resulting in structural alteration to this endocrine gland. Arrington and Davis<sup>6</sup> in the course of their studies on toxic molybdenosis in rabbits have indicated a paresis of the hind limbs accompanied by wasting of the pelvic region. It is highly likely that this con-

dition is a sequel to a molybdenum-induced cortical insufficiency giving rise to the manifestation of Addison's disease. Further work is in progress to evaluate the adrenal pituitary balance in experimental molybdenosis.

Dept. of Biochemistry, P. P. NAIR.  
Institute of Science, N. G. MAGAR.  
Bombay-1, January 31, 1958.

1. Nair, P. P., Doctoral Thesis: *Metabolic Interrelationship between Vitamin E and Molybdenum*, University of Bombay, December, 1956.
2. — and Magar, N. G., *Ind. J. Med. Res.*, July 1958 (in press).
3. — and Bharadwaj, T. P., *J. Postgraduate Med.*, 1956, **2**, 163.
4. Brummer, L. H., *Ann. Acad. Sci. Fennica*, 1955, **45**, 57.
5. Heinsen, H. A. and Koker, H., *Deut. Med. Wochchr.*, 1951, **76**, 487.
6. Arrington, L. R. and Davis, G. K., *J. Nutrition*, 1953, **51**, 295.

### SYNTHESIS OF 4-HYDROXY-6-SULFONAMIDE-QUINOLINE DERIVATIVES

PRICE, LEONARD AND STACY<sup>7</sup> attempted to prepare 4-hydroxy-6-sulfonamide-quinoline by the application of ethoxymethylenemalonic ester synthesis to sulfanilamide but, all their attempts to cyclize the condensation product obtained from sulfanilamide and ethoxymethylenemalonic ester proved futile. Riegel *et. al.*<sup>2</sup> also experienced the same difficulty with sulfanilamide. In our hands, the thermal cyclization of the sulfanilamide condensation product in boiling diphenyl ether, under controlled conditions, gave a pale yellow product,

crystallized from nitrobenzene, m.p. 240° C. (with decomp.). However, this could not be obtained in an analytically pure form.

Thinking that the free amino group of -SO<sub>2</sub>NH<sub>2</sub> interfered in the smooth cyclization, a N<sup>1</sup>-substituted sulfanilamide, i.e., sulfathiazole was chosen and the reaction was repeated.

Expectedly, all the steps were smooth. Thus, on heating a mixture of sulfathiazole (1 mol.) and ethoxymethylenemalonic ester (1 mol.) in benzene the condensation product (I) was obtained in quantitative yield, crystallized from aqueous ethanol, m.p. 165-66° C. (Found: C, 48.3; H, 4.7; N, 9.7. C<sub>17</sub>H<sub>16</sub>N<sub>3</sub>O<sub>6</sub>S<sub>2</sub> requires C, 48.0; H, 4.5; N, 9.9.) The condensation product (I) on heating in boiling diphenyl ether under controlled conditions gave the cyclized product (II) in 93% yield, crystallized from nitrobenzene in rhombic needles, m.p., 281-82° C. (with decomp.). (Found: C, 47.2; H, 3.5; N, 11.7; S, 16.5. C<sub>15</sub>H<sub>13</sub>N<sub>3</sub>O<sub>5</sub>S<sub>2</sub> requires C, 47.5; H, 3.5; N, 11.1; S, 16.9.) The saponification of (II) was accomplished in quantitative yield by refluxing with excess of 10% sodium hydroxide for 2 hr. and subsequent neutralization. The acid (III), being very sparingly soluble in organic solvents, was directly decarboxylated by heating in boiling diphenyl ether for 1½ hr. The 4-hydroxy quinoline derivative (IV) obtained on cooling was washed with petroleum ether and finally crystallized from a large volume of nitrobenzene in shining microscopic needles, m.p., 312-13° C. (with decomp.), yield 83-84%. (Found: C, 46.7; H, 2.6; N, 13.3. C<sub>12</sub>H<sub>9</sub>N<sub>3</sub>O<sub>3</sub>S<sub>2</sub> requires C, 46.9; H, 3.0; N, 13.7.)

The condensation product from sulfaguandine obtained in quantitative yield crystallized from aqueous ethanol, m.p., 186-87° C. (Found: C, 46.7; H, 4.9; N, 14.7. C<sub>15</sub>H<sub>20</sub>N<sub>4</sub>O<sub>6</sub>S requires

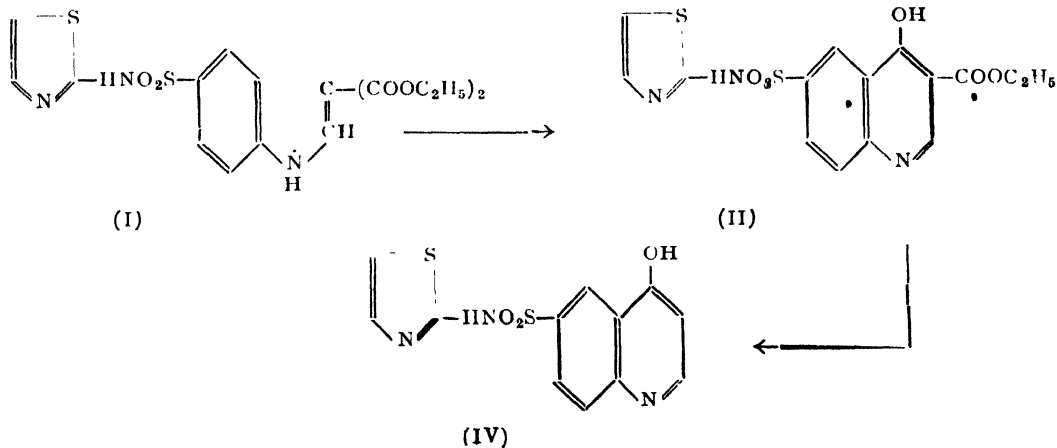



C, 46.9; H, 5.3; N, 14.6), because of the presence of free amino groups, presented the same difficulty during cyclization. Work, now in progress to prepare 4-hydroxy quinoline derivatives from other sulfanilamides and their conversion to 4-alkylaminoquinolines for testing their biological activity, will be reported elsewhere.

Dept. of Chem. KASHINATH S. SARDESAI,  
Technology, S. V. SUNTHANKAR.  
University of Bombay,  
Matunga, Bombay-19,  
February 27, 1958.

1. Price, C. C., Leonard, N. J. and Stacy, G. W., *J. Am. Chem. Soc.*, 1947, **69**, 855.
2. Riegel, B. *et al.*, *Ibid.*, 1946, **68**, 2636.

### GLUTAMIC ACID DECARBOXYLASE IN FUSARIA

DURING an investigation of the amino acid composition of *Fusaria*<sup>1</sup> by circular paper chromatography<sup>2,3</sup>  $\gamma$ -aminobutyric acid was identified in the acid hydrolysate of *Fusarium vasinfectum*. Confirmation for its presence was obtained by running a mixed chromatogram with an authentic and pure sample of  $\gamma$ -aminobutyric acid.<sup>4</sup>

A two-dimensional chromatogram using *n*-butanol-acetic acid-water (40:10:50) as the first solvent and pyridine water (80:20) as the second established the presence of this acid beyond doubt. The test solutions were spotted at one corner of a square filter-paper (25 × 25 cm.) which was rolled into the form of a cylinder, stitched at two points and dipped in the butanol solvent in a petri-dish at the bottom of a cylindrical jar of suitable size. The jar was covered with a greased plate. When the solvent front had ascended up to the end of the paper they were removed, air-dried and rolled into the form of cylinder in another direction and developed in pyridine water. After the two developments they were dried and sprayed with ninhydrin. Each run took about 25 hours.

The presence of  $\gamma$ -aminobutyric acid in *F. vasinfectum* rendered interesting a study of the enzyme systems implicated in its formation. Therefore the activity of the enzyme glutamic acid decarboxylase was determined by the circular paper chromatography.<sup>5</sup> The order of efficiency of the carbon and nitrogen sources for the enzyme activity were as follows:  
Fructose > Sucrose > Maltose > Glucose >

Manose > Lactose > Galactose.  
(NH<sub>4</sub>)<sub>2</sub>SO<sub>4</sub> > NH<sub>4</sub>Cl > NH<sub>4</sub>NO<sub>3</sub> > KNO<sub>3</sub> > NaNO<sub>3</sub>.

An alkaline pH had a deleterious effect on the enzyme activity while an acid environment had a favourable influence. The optimal enzyme activity was found at pH 4.5 and 30° C. The enzyme activity which was little in young cultures increased with age and coincided with the stage when the cells were in resting condition. It was at maximum on the 16th day. It gradually diminished when the cells started to autolyse.

Decarboxylation of L-glutamic acid to  $\gamma$ -aminobutyric acid is known to occur in plants, animals, bacteria and yeast. Details of investigations carried out on this enzyme of *F. vasinfectum* will be published elsewhere.

I am very grateful to Professors Dr. S. V. Anantakrishnan and Dr. T. S. Sadasivan for their guidance and encouragement.

Dept. of Chemistry, S. NATARAJAN,\*  
Madras Christian College,  
Tambaram, March 7, 1958.

\* Present Address:—Research Assistant, Dept. of Biochemistry, Indian Institute of Science, Bangalore-3.

1. Natarajan, S., *J. Indian bot. Soc.*, 1958, **37** (In Press).
2. Giri, K. V. and Rao, N. A. N., *Nature*, 1952, **169**, 923; *J. Indian Inst. Sci.*, 1952, **34**, 95.
3. — and Nagabhushanam, *Naturwissenschaften*, 1952, **39**, 548.
4. — and Rao, N. A. N., *Curr. Sci.*, 1953, **22**, 114; *J. Indian Inst. Sci.*, 1952, **34**, 95; 1953, **35**, 343.
5. —, Radhakrishnan, A. N. and Vaidyanathan, C. S., *Nature*, 1952, **170**, 1025; *J. Indian Inst. Sci.*, 1952, **34**, 305; *Anal. Chem.*, 1952, **24**, 1677.

### A SHORT NOTE ON THE TESTING OF R.W. COEFFICIENT AT DIFFERENT TEMPERATURES

It is maintained in the text-books that the test for R.W. Coefficient should be carried out at 20° C. This no doubt appears to be very pertinent. But on analysis it will be found there may not be much point in insisting on a particular temperature. The germicidal activity of phenol will increase with the rise of temperature but this will also be the case with the disinfectant that is being tested and compared with the phenol. Since both the reactions will increase with a rise in temperature a gross change in the R.W. Coefficient may not occur. The present work has been undertaken to test this hypothesis.

TABLE I  
Results  
Rideal-Walker coefficients at different temperatures

Disinfectant	Reaction Temperature	1st Test			2nd Test		
		Dilution at which <i>S. typhi</i> are killed in 7½ mins.		R.W.C.	Dilution at which <i>S. typhi</i> are killed in 7½ mins.		R.W.C.
		Disinfectant	Phenol		Disinfectant	Phenol	
DETJOL	15° C.	1 : 300	1 : 100	3	1 : 300	1 : 100	3
	20° C.	1 : 350	1 : 115	3.04	1 : 350	1 : 100	3.5
	25° C.	1 : 350	1 : 125	2.8	1 : 350	1 : 100	3.5
	30° C.	1 : 350	1 : 125	2.8	1 : 400	1 : 125	3.2
	35° C.	1 : 450	1 : 130	3.46	1 : 400	1 : 125	3.2
CYLLINE	15° C.	1 : 400	1 : 110	3.64	1 : 350	1 : 100	3.5
	20° C.	1 : 500	1 : 120	4.2	1 : 400	1 : 100	4
	25° C.	1 : 550	1 : 125	4.4	1 : 500	1 : 120	4.2
	30° C.	1 : 550	1 : 125	4.4	1 : 500	1 : 125	4
	35° C.	1 : 550	1 : 125	4.4	1 : 500	1 : 120	4.2

In the undermentioned experimental tests Lister strain of *Salmonella typhi* after five sub-cultures in broth has been used. Cultures treated with various concentrations of disinfectant have been transferred with a standard 4 mm. platinum loop, to nutrient broth tubes each 30 secs. and incubated at 37° C. for 24 hours. The results are given in the accompanying table.

As far as the above disinfectants are concerned, the various temperatures at which the tests have been carried out do not appear to affect the value of R.W. Coefficient materially.

Central Drug Res. Inst., A. MUKHERJI.  
Lucknow, December 18, 1957.

**A TERATOLOGICAL PHENOMENON IN  
*LAGENARIA SICERARIA* STANDL.**

*Lagenaria siceraria* Standl., commonly known as bottlegourd, is a pubescent angular trailing herb of cucurbitaceæ family and is largely cultivated as a vegetable crop. It is a monœcious plant and its stem possesses distinct nodes and internodes. Normally, a node bears a leaf with single staminate or pistillate flower, a bifid tendril and a vegetative shoot. The pistillate flowers are short peduncled unlike the staminates, which are borne on long peduncles. The nodes are discernible from one another by the existence of angular internodes.

Recently, on a bottlegourd plant, about 40 pistillate flowers were found borne in a bunch giving the appearance of a pseudo-inflorescence,

which is not the characteristic feature of this species. After setting, it looked like a bunch of fruits but only one such bunch could be recorded on the entire length of the vine (Fig. 1).



FIG. 1. Bunch of young fruits and flowers.

On close examination of this bunch, it was observed that it exhibited a teratological feature resulting from the shortening of the

internodes and fusion of the stem nodes. The emergence of leaf and shoot on the nodes were altogether suppressed. Only the bifid tendrils were present in a minute form on each node beside the fruit or pistillate flower, which confirmed this observation. The pistillate flowers were borne in acropetal succession on the main and side branches. They were normal, regular and epigynous like the rest on the vine.

Although various forms of abnormalities have been noted in cucurbitaceæ by Masters (1869), the present type of teratological phenomenon in *Lagenaria siceraria* Standl. was recorded for the first time.

Horticultural Res. Inst.,  
Saharanpur,  
December 14, 1957.

L. B. SINGH.  
S. N. SINGH.

1. Masters, M. T., *Vegetable Teratology*, London, 1869.

### INFLUENCE AND MECHANISM OF ACTION OF LOW TEMPERATURE PRE-TREATMENT ON GERMINATION OF TOBACCO SEEDS

WORKING on the germination of tobacco seeds (*Nicotiana tabacum*) we find that the seeds of the flue-cured variety Harrison Special germinate poorly at high temperatures. The actual germination figures were 63.1% at 32.2°C., 31.8% to 38.6% at 35°C. and only 9.0% at 37.8°C. compared to over 96% between the temperature range of 17.8°C. to 27.8°C. In general these observations confirm the results obtained by Johnson *et al.*<sup>1</sup> and Kincaid.<sup>2</sup>

If, however, the seeds are pre-treated after soaking at low temperatures for various periods the germinating capacity increases very appreciably (Table I) when tested for germination at the same temperatures. This effect is similar to the numerous cases of 'after-ripen-

ing' of dormant seeds by stratification or by cold temperature treatment reported in literature.<sup>3 5</sup>

But there are three important differences: (1) the seeds of tobacco when treated were not dormant in the usual sense as they readily germinated almost fully between the temperatures of 17.8°C. to 27.8°C.; (2) the effect of pre-treatment, in general, was additive, *i.e.*, longer the period of pre-treatment, better was the germination; and (3) the period of pre-treatment to which the seeds reacted was counted in hours and days compared to the treatment of months necessary for 'after-ripening' in the dormant seeds. The most comparable record seems to be that of germination of *Delphinium*,<sup>6</sup> which showed an increase from 82% to 92% at 15°C. (59°F.) and from 62% to 76% at 20°C. (68°F.) after pre-treatment for 4 days to the temperatures of 0.5°C. (33°F.) and 5°C. (41°F.) respectively. However, the differences between after-ripening of dormant seeds and the reaction to the low temperature treatments mentioned above may only be of a quantitative rather than of a qualitative nature.

In order to explain the observed facts it is suggested that germination in tobacco may be considered to consist of 2 stages:

*Stage A.*—The stage of 'after-ripening'. At this stage an inducer substance which may be termed as 'germigen' is produced in the seed, without which the next stage (*i.e.*, the development of the seedling) cannot take place. In tobacco, this stage can proceed on at the low temperatures of 5.6°C. to 22.2°C. when wetted, although there is no visible germination at temperatures below 12°C. because such a temperature is lower than the minimum cardinal temperature for germination.

*Stage B.*—The stage of development of the seedling. This stage cannot be initiated until an adequate amount of 'germigen' is available in the seed, lack of which keeps the seed dor-

TABLE I

Percentage germination at different temperatures after pre-treatment of soaked seeds to low temperatures for various periods

Incubation Temperature	Pre-treatment Temperature	Duration of pre-treatment						
		No pre-treatment 0 hrs.	12 hrs.	1 day	2 days	4 days	6 days	8 days
7.8° C.	22.2°	9.0	11.2	13.7	13.4	20.1	23.4	26.7
	22.2°	31.8	36.7	31.2	33.4	49.6	63.2	63.0
	11.1°	38.6	41.7	50.1	58.9	80.0	88.6	87.0
	5.6°	36.7	40.6	40.6	43.0	51.1	61.1	68.2

mant in spite of other conditions being favourable.

It also seems that the quantity of 'germigen' required for germination at higher temperatures is larger than at lower temperatures and therefore more seeds remain dormant at the higher temperatures, the supply of 'germigen' being inadequate for this purpose. With pre-treatment a higher 'germigen' level is reached, and this results in comparatively high germination at all incubation temperatures; but as long as pre-treatment is incomplete, the trend of more number of seeds germinating at lower temperatures is maintained. When pre-treatment is adequate, as was obtained in some other experiments with 8 days' pre-treatment at 17.8° C., a germination of over 96% was possible even at 35° C.

Considering that the seeds germinated to over 96% within the temperature range of 17.8° C. to 27.8° C. without pre-treatment, it is evident that within this temperature range both the stages A and B could be completed simultaneously. At such temperatures, therefore, there is no possibility of recognising the two stages. This probably is the reason why the two stages in germination have escaped attention in other species. A fuller account of the experiments will be published elsewhere.

Our thanks are due to Dr. N. R. Bhat, Director, Tobacco Research, Central Tobacco Research Institute, Rajahmundry, for his kind interest in this work.

Central Tobacco Res. Inst., N. L. PAL.  
Rajahmundry, N. C. GOPALACHARI.  
July 26, 1957.

1. Johnson, J., Murwin, H. F. and Ogden, W. B., *Wis. Agr. Expt. Sta. Bull.*, 1930, **104**, 1-15.
2. Kincaid, R. R., *Fl. Agr. Expt. Sta. Bull.*, 1935, **277**, 1-47.
3. Crocker, W. and Barton, L. V., *Physiology of Seeds* (Chronica Potanica Co., Waltham, 1953).
4. Barton, L. V. and Crocker, W., *Twenty Years of Seed Research* (London, 1948).
5. Toole, E. H., et al., *Ann., Rev. Plant Physiol.*, 1956, **7**, 299-319.
6. Barton, L. V., *Boyce Thos. Inst. Prof. Paper*, 1933, **26**, 248-50.

#### INFLUENCE OF CERTAIN SPECIES OF EARTHWORMS ON THE STRUCTURE OF SOME HILL SOILS

CERTAIN species of earthworms in some soils of Himachal Pradesh have been found to affect the soil structure adversely. The earthworms form small castings into lumps which on drying become cement-like hard clods. Within a few years of infestation, the entire fertile soil

having good structure becomes cloddy, structureless and unproductive. Many acres of land thus has lost its productivity.

The earthworms are pinkish to brown in colour and have small segments. Their size varies from 1" to 6" and they are very active. Their activities are confined to about 15" of the top soil and during unfavourable conditions they hibernate in the subsurface soil. As many as 250 worms per square foot of soil have been counted in the average infested lands.

Living and dead specimens of the worms were sent for identification to the Director, Zoological Survey of India, Calcutta, who has reported the same to represent the genus *Allobophora* of the family *Lumbricidae* (Order *Oligochaeta*). Most of the worms belonging to the genus *Allobophora* are known to be largely distributed over England, Ireland and are generally reported to be found in the Arctic regions. They are the only earthworms capable of burrowing through snow and ice.

The worms prefer heavy, compact soil and flourish well on organic matter and manure prepared from pine-tree leaves. The infested soils are situated at elevations of 7,000' to 8,000' above sea-level and have cool summers with a monsoon rainfall of about 60". These soils remain under snow for 3 to 4 months in winter. Texture of these soils is silty clay to clay loam and their colour varies from pale brown to dark brown. The pH of these soils varies from 5.8 to 6.8.

Microscopic studies show that these worms excrete some colourless waxy fluid from their nymphridia. This waxy fluid adheres to the soil particles and castings and it makes a gelatin-like membrane around them. This colourless waxy fluid perhaps functions as the cementing material to the castings and thus hard clods are formed.

Further work on this as well as remedies for rectification of the defects is in progress and will be reported separately.

Deptl. of Agriculture, G. S. AGARWAL.  
Himachal Pradesh, K. S. K. RAO.  
Simla, January 4, 1958. L. S. NEGI.

1. Barret, T. J., *Harnessing the Earthworms* (Faber & Faber, New York).
2. Day, G. M., *Soil Science*, 1950, **69**, 175-84.
3. Dawson, R. C., *Soil Science Society of America Proc.*, 1947, **12**, 512-16.
4. *Encyclopaedia Columbia*, **2**, pp. 583.
5. *Encyclopaedia Britannica*, **1**, pp. 994-95.
6. Quastel, J. H., *Soil Science*, 1952, **73**, 419-25.
7. Russel, E. J., *Journal of Agricultural Science*, 1910, **2**, 245-57.

ON THE OCCURRENCE AND LIFE-  
CYCLE OF THE JAK WEEVIL  
(*OCHYROMERA ARTOCARPI*, MAR-  
SHALL) AT COIMBATORE

THE Jak weevil *Ochyromera artocarpi*, Marshall has been so far reported from North Malabar and Mysore only (Ramakrishna Ayyar, 1932, 1940). Recently, during November 1957, this weevil was noted for the first time occurring in large numbers on jak (*Artocarpus heterophyllus*, Lamk.) growing in the gardens attached to the Agricultural College and Research Institute, Coimbatore. The grubs of the weevil were found boring the inflorescence with the result a large number of them dropped down. All stages were present inside the fallen buds. Since no information is available on the life-history and habits of the weevil, a study was undertaken during the month of December 1957 in the cold season when the average maximum and minimum temperatures were 83.4° F. and 67.0° F. respectively and observations are presented below in brief.

The adult is a small, active, greyish brown weevil measuring 3.5 mm. in length and 1.5 mm. in breadth, with the whole body thinly clothed with fine setiform golden scales and set with suberect setæ and elytra bearing numerous irregular and ill-defined small bare spots. It is often found in groups feeding on the tissue of inflorescence. Eggs are laid singly in small cavities excavated by the adults in the inflorescence. The egg is pearly white, smooth and oblong oval measuring on an average 0.42 mm. in length and 0.28 mm. in width. The eggs hatch in 3 to 4 days and the newly hatched

through the tissue in all directions and becomes mature in 12 to 15 days. The full-grown grub is whitish in colour measuring 4.9 mm. in length. Its head is light brown but darker at the frontal region and much narrower than thorax and with a conspicuous dark line in the frons. The body is moderately curved, tapering towards the posterior region. Pupation takes place in a cavity at the end of the larval burrow. The pupa is naked, whitish in colour and is about 3.6 mm. long and 1.5 mm. broad with numerous setigerous tubercles on the body. The pupal stage lasts for 5 to 6 days. The adult emerges by boring a hole on the outer skin. The total life-cycle of 28 individuals ranged from 20 to 25 days. The longevity of the weevil was rather short under captivity which ranged from 6 to 23 days for females and 5 to 18 days for males. The egg-laying capacity also was poor in captivity and the number of eggs laid by 15 individuals varied from 18 to 38.

Entomology Section, T. R. SUBRAMANIAN.  
Agric. College & Res. Inst.,  
Coimbatore, February 1, 1958.

1. Ramakrishna Ayyar, T. V., *Bull. Mad. agric. Dep.*, 1932, 27, 48.
- 2 —, *Handbook of Economic Entomology for South India*, 1940, 319,—Suptd., Govt. Press, Madras.

ROOT-KNOT NEMATODES ON  
POTATOES IN INDIA

SURVEY carried out in the principal potato-growing regions in the country has shown that root-knot nematodes (*Meloidogyne* spp.) are common pests of potatoes, with a wide host range. The disease caused by root-knot nematodes is not easy to recognise in the field as, very often, no symptoms above-ground are visible. Sometimes, however, severely attacked plants are stunted and may even show signs of premature wilting.<sup>3</sup>

In this country the species of *Meloidogyne*, attacking potato tubers, have been found to occur in over a wide area, and pathogenic species, inciting gall-formation on potato, have been collected from the following tracts:

Other susceptible plants recognised under conditions prevailing in the plains are *Lycopersicon esculentum*, *Brassica oleracea*, *Solanum nigrum*, *Solanum melongena*, *Achyranthus aspera*, *Ruellia* sp., *Coleus perviflorus*, *Physalis minima* and *Chenopodium album*.

Root-knot nematodes found in the plains on wild susceptible plants can, under favourable

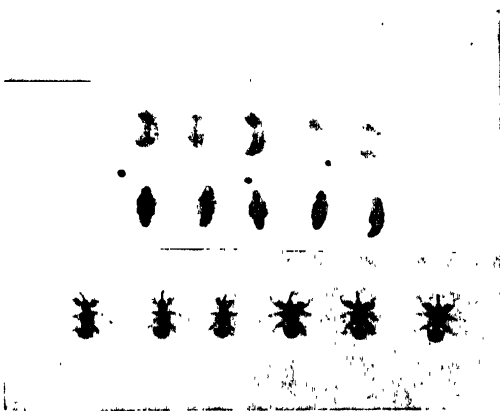

FIG. 1. Stages of Jak weevil (*Ochyromera artocarpi*, M.). legless grub is pale white with a pale brown head and measures 0.56 mm. in length. It bores

Location	Altitude above sea-level	Species involved
1 Uttar Pradesh (Almora and Bhowali areas) ..	4,000 to 6,000 ft.	<i>M. javanica</i> (Treub) Chitwood <i>M. incognita acrita</i> Chitwood
2 Simla Hills (covering regions around Theog-Mashobra valley)	5,500 to 6,500 ft.	<i>M. incognita acrita</i>
3 Bihar (Chotanagpur, hill regions of Ranchi and Netarhat)	2,500 to 3,700 ft.	<i>M. incognita</i> (Kofoid and White) Chitwood
4 Assam (throughout Shillong Hills)	5,000 to 6,000 ft.	<i>M. incognita</i>
5 Mysore (Chickballapur)	About 3,000 ft.	<i>M. javanica</i> ; <i>M. incognita acrita</i>

conditions, act as collateral hosts for the potato tuber infection. One of these is 'Kurkon' (*Coleus perviflorus*) which shows heavy gall-formation on roots infested with *M. incognita* (Fig. 2). In

the plants grown on nematode inoculum derived either from *Coleus* roots and from the potato tubers showed typical root-knot symptoms (Fig. 1) whereas the control was completely free from infestation (Fig. 1).



FIG. 1. (a) 'Kurkon' roots showing heavy gall-formation as a result of infestation with *M. incognita*.

(b) Normal roots of 'Kurkon'

an experiment, 48 healthy plants of Up-to-date variety of potato were raised in pots containing sterile soil. They were divided into three sets of 16 plants each. To the first set, leachings of roots from 'Kurkon' infested with root-knot nematodes were added. To the second set of sixteen pots leachings from infested potato tubers carrying *M. incognita* on *Satha* variety secured from Ranchi were added. The third set served as control. All the pots were kept in a cool situation under shade. Sixty days after inoculation the tubers produced from all

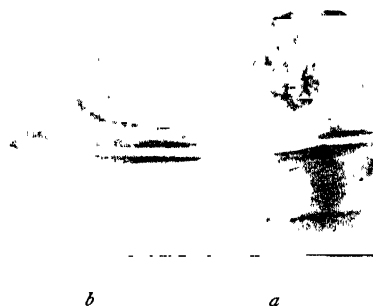

FIG. 2. (a) Potato tuber infected with root-knot nematode derived from 'Kurkon' roots  
(b) Control—normal potato tuber.

Earlier reports in this country of *Heterodera marioni* (Cornu) Goodey<sup>2</sup> being associated with gall-formation on potato should now be regarded as being caused by *Meloidogyne* sps.

We are grateful to Drs. M. T. Franklin and J. B. Goodey of Rothamsted Experimental Station, Harpenden, Hertfordshire, England, who have helped to identify the root-knot nematodes found associated with several plants.

Central Potato Res. Institute, Simla, January 17, 1958.  
PUSHKARNATH,  
B. N. ROY CHOUDHARY.

- Steiner, G., 'Plant nematodes the grower should know,' *Dept. Agric. Florida. Bull.*, 1953, **131**, 48.
- Thirumalachar, M. J., 'Root-knot nematodes of potato tubers in Simla,' *Curr. Sci.*, 1951, **20**, 104.
- Walker, J. C., *Root-knot Disease of Potato in Disease of Vegetable Crops*, McGraw Hill, 1952, p. 370.

**EFFECT OF IAA AND KINETIN ON  
POLLEN TUBES OF *PINUS*  
*ROXBURGHII* SAR.**

EVER since 1834, when von Mohl (see O'Kelley, 1955) first noticed the germination of pollen grains in moist air, several attempts have been made to culture them artificially. It has been observed that pollens differ considerably in their power to germinate *in vitro*. However, in most cases the percentage of germination is lower and the length of the pollen tube considerably shorter than what is obtained under natural conditions. While sucrose is the principal component of the medium, germination and tube growth can be improved by incorporating boric acid, hormones and vitamins. Besides, in a number of cases, the use of plant tissue extracts has also given very favourable results.

Male cones of *Pinus roxburghii* were obtained from the plants growing near Vijay Chowk, New Delhi. The mature pollen showed two degenerated prothallial cells, the tube nucleus and the generative cell.

Pollen grains were cultured by the hanging drop technique. The cultures were stored at room temperature and exposed to diffuse laboratory light. The\* culture medium comprised 15% sucrose, 0.66% agar, and 0.01% boric acid. This will be referred to hereafter as the basic medium. In some cases indoleacetic acid (2.5 p.p.m.) and in others kinetin (0.01%) was added after the pollen grains had grown for 3 days on the basic medium. For treating with IAA or kinetin, the cover glass was carefully removed, a drop of the chemical added with the help of a camel hair brush and the cover glass immediately replaced. After the pollen tubes had ceased to elongate, the coverglass with the agar film was removed and dried in the air, fixed in F.A.A., stained in acetocarmine and dehydrated in the tertiary-butyl alcohol-xylol series. The percentage of germination was determined by counting more than 100 grains from five or more different fields of the microscope. The tube length given is the average of 20 tubes. All readings were taken under the high power of the microscope after 8 days growth. Pollen grains cultured in sucrose-agar medium showed very little growth. To overcome this difficulty, 0.01% boric acid was added to the sucrose-agar medium. In this medium germination took place after about 48 hours. The percentage of germination

varied from 78 to 82 and the average tube length was  $203\mu$  (Figs. 1, 7). In IAA medium 80% of the pollen grains germinated and showed  $490\mu$  long tubes (Figs. 2, 7). Although in the kinetin medium the length of the pollen tube increased to  $586\mu$  (Figs. 3, 7), the germination was only 74%.

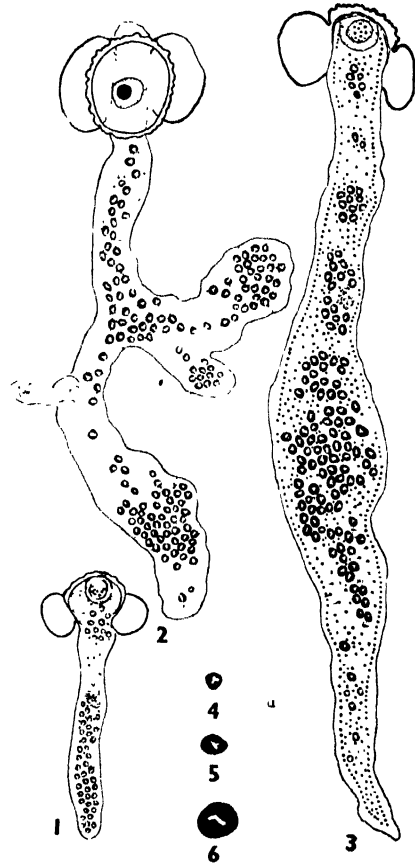

FIGS. 1-6.

Fig. 1. Germinated pollen grain in basic medium,  $\times 560$ . Fig. 2. Same, in basic medium + IAA,  $\times 560$ . Fig. 3. Same, in basic medium + kinetin,  $\times 560$ . FIGS. 4-6. Relative sizes of the starch grains in the basic medium; basic + IAA; and basic + kinetin,  $\times 1,070$ .

No branching or swelling of the tip of the pollen tube occurred in the basic medium and the tubes followed a straight course. However, when IAA was added there was profuse branching. In kinetin, on the other hand, branching was scarce but there was general swelling of the pollen tubes. Division of the antheridial cell was not induced by these chemicals. No relation could be seen between the branching of the tube and the position of the tube nucleus as recently reported by Tanaka (1956) in *Pinus densiflora*.

\* All chemicals used were of the analytical reagent (AR) grade. Pyrex double distilled water was used throughout.

At the beginning of the experiment, no appreciable quantity of starch could be seen either in the pollen tube or in the pollen grains. In the basic medium starch was seen in the pollen grain as well as the tube but the amount is small and the grain size does not exceed  $3\mu$  (Fig. 4) in diameter; the cytoplasm is more or less uniform and without much vacuolation. In the IAA medium most of the starch is concentrated around the tube nucleus and at the tip of the pollen tube; the diameter of the starch grains is about  $5.2\mu$  (Fig. 5) and the latter have a prominent hilum. In kinetin the grain size is  $7\mu$  in diameter (Fig. 6). In both IAA and kinetin media the cytoplasm was scanty and vacuolated.

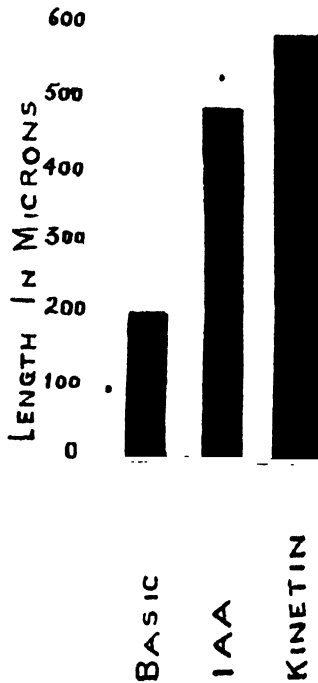

Fig. 7 Histogram indicating pollen tube length in microns in the basic medium; basic medium + IAA (2.5 p.p.m.); and basic medium + kinetin (0.01%).

As is well known, the pollen tubes of *Pinus* remain in the resting condition in the nucellus for about 9 months. It is hard to believe that they survive this long period by utilizing only the stored food unless it is agreed that they also absorb and utilize food from the nucellar tissue. Since the time of Schleiden (1849) and Van Tieghem (1869; see Brink, 1924), several attempts have been made to culture the pollens of different plants in sugar solutions. In the angiosperms the reserve food material of

the pollen grains may be sufficient in some cases to support an appreciable amount of growth. But in conifers like *Pinus* an intake of food material is essential as about 3 months elapse from the time the pollen tube resumes growth to the time of fertilization. Mangin (1866; see Brink, 1924) first noted that the pollen grains of some species, when placed in sugar solution, accumulate starch freely. Confirmation of this also came from Tischler (1917; see Brink, 1924). In *Pinus laricio*, Dodel Port (1880, see Brink, 1924) reported that on a concentrated sugar solution the pollen tube shows an accumulation of starch. From these observations it may be concluded that sucrose is taken up and converted into starch. *In vivo* also pollen tubes in the nucellus show a good accumulation of starch. This fact has recently been further confirmed by the work of Hellmers and Machlis (1956) who have shown, both qualitatively and quantitatively, that the pollen tubes of *Pinus ponderosa* absorb and utilise carbohydrates present in the culture medium. O'Kelley (1955, 1957) has also demonstrated, by the use of  $C^{14}$ -labelled sugars, that sugars are absorbed and used in the respiration of germinating pollen tubes of *Tecoma radicans*. The greater accumulation of starch in the pollen tubes of *Pinus roxburghii* when supplied with kinetin and IAA suggests that these chemicals probably enable the pollen tubes to absorb larger quantities of sugars from the medium and convert it to starch.

I am greatly indebted to Prof. P. Maheshwari under whose guidance this work was carried out. My thanks are also due to Mr. I. K. Vasil who helped me in the pollen culture work.  
Botany Department, R. N. KONAR.  
University of Delhi,  
February 14, 1958.

1. Brink, R. A., "The physiology of pollen, II", *American J. Bot.*, 1924, **11**, 283-94.
2. Hellmers, H. and Machlis, L., "Exogenous substrate utilization and fermentation by the pollen of *Pinus ponderosa*," *Plant Physiol.*, 1956, **31**, 284-89.
3. O'Kelley, J. C., "External carbohydrates in growth and respiration of pollen tubes *in vitro*," *American J. Bot.*, 1955, **42**, 322-27.
4. —, "Boron effect on growth, oxygen uptake and sugar absorption by germinating pollen," *Ibid.*, 1957, **44**, 239-44.
5. Tanaka, K., "The pollen germination and pollen tube development in *Pinus densiflora* Sieb. et Zucc. II. The tube growth and tube nucleus," *Sci. Rep. Tohoku Univ.*, 1956, **22**, 219-24.
6. Schleiden, M. J., *Principles of Scientific Botany* (*Trans.*), London, 1849.



### NOTE ON THE ESTIMATION OF STARCH IN SUGARCANE

QUALITATIVE examination for starch of different species of *Saccharum* and allied genera at this Institute<sup>1</sup> has shown that fairly large quantities of starch are found in them. For the quantitative determination of starch in sugarcane, the  $\beta$ -amylase method as used by Hanes<sup>2</sup> was successfully employed and has been in use at this Institute for quite a long time. Balch<sup>3</sup> and Alexander<sup>4</sup> have recently reported colorimetric method for the determination of starch content in cane juices. An examination of the efficacy of the two methods revealed certain characteristic differences which are reported in this note.

The starting material for the determination of starch in both the methods is the residue left after the sugars are thoroughly extracted with 85% alcohol. Using 1 g. of sugar-free residue, starch extracts were prepared with neutral calcium chloride according to the method of Balch (*loc. cit.*) and by solubilisation with alcoholic hydrochloric acid and hot water extraction as adopted by Hanes.

Using suitable aliquots of the two extracts, the amount of starch present in them was determined according to Balch in a Hilger photo-electric colorimeter, A. R. soluble starch being used as standard. Simultaneously, a 25 c.c. aliquot of starch extract obtained according to Hanes was treated with 2 c.c. of acetate buffer and 2 c.c. of  $\beta$ -amylase and the reducing power of the hydrolysate was determined in terms of maltose using Somogyi<sup>5</sup> reagent recommended for maltose estimation.

The results obtained by the colorimetric method and the enzyme hydrolysis method are given in Table I. It can be seen from the table that in general the values obtained by the colorimetric method are definitely lower than those obtained by the  $\beta$ -amylase method. At higher concentrations, however, the differences between the values obtained by the two methods were less marked though the values obtained by the colorimetric method are relatively low. It is also observed that at lower concentrations of starch, for example, as in the case of Co. 419 (Table I) the chromogen formed (according to Balch) was very feeble and as such its intensity could not be measured. At higher concentrations, on the other hand, the variation in the values of the two methods was much less. For the estimation of starch in sugarcane, therefore, the enzyme hydrolysis method of Hanes is found more suitable.

TABLE I

Table showing the comparison between the colorimetric method and the  $\beta$ -amylase hydrolysis method

Variety	Description of sample	Solution A*		Solution B <sup>†</sup>
		Colorimetric method	Enzyme hydrolysis method	Colorimetric method
<i>Erianthus</i>	Bottom stem	3.010	3.692	2.940
	do	..	3.578	2.557
	do	3.855	4.160	4.066
	do	4.65	4.522	4.566
	do	1.80	2.975	1.660
Katha	Green leaves	0.256	1.239	0.4375
	do	0.248	1.221	0.4175
	do	0.5558	1.368	0.6581
	do	0.6670	1.709	1.180
	do	..	0.9572	0.295
Co. 419	Bottom stem	+	0.6836	+
	do	+	0.7519	+
	do	+	0.4443	+
	Green leaves	+	0.7861	+
	do	+	0.6665	+
do	+	0.7578	+	

(All percentages on residual dry weight basis.)

\* *Solution A*—Starch extract obtained according to the method of Hanes (*loc. cit.*).

<sup>†</sup> *Solution B*—Starch extract obtained according to the method of Balch R. T. (*loc. cit.*).

+ Positive indication for the presence of starch.

Thanks are due to Shri N., L. Dutt, Director, for affording all facilities.

Sugarcane Breeding Inst., K. V. GOPALA AIYAR,  
Post Lawley Road, K. CHIRANJIVI RAO.  
Coimbatore,  
March 3, 1958.

1. Dutt, N. L. and Narasimhan, R., *Curr. Sci.*, 1949, **9**, 346.
2. Hanes, C. S., *Biochem. Journal*, 1936, **30**, Pt. 1, 168.
3. Balch, R. T., *The Sugar Journal*, 1953, **15**, (8), 11-15.
4. Alexander, J. B., *South Afri. Sug. Jour.*, Sept. 1954.
5. Somogyi, M., *J. Biol. Chem.*, 1945, **10**, 61.

### ON THE PHENOLIC CONTENT OF SUGARCANE AND SPONTANEUM JUICES

PHENOLS in sugarcane juice are mainly tannin and anthocyanin of the rind. These are referred to as polyphenols. The quantitative study of phenols in cane juices has not so far received much attention. Colorimetric methods are generally found more suitable for estimat-

ing phenols in plant fluids. The Folin-Denis<sup>1</sup> colorimetric method is not found satisfactory for cane juices as appreciable amounts of non-phenolic reducing substances including glucose<sup>2,3</sup> interfere with the colour development. The diazotised sulphanic acid reagent of Fox and Gange<sup>4</sup> as used by Miller and Urbain<sup>5</sup> for estimating phenols in water was found most satisfactory for the direct determination of phenols including cane tannin in raw cane juices. The procedure of estimation and some preliminary data on the phenolic content of the juices of a few cultivated Co. canes and wild spontaneums are reported in this paper.

Centrifuged fresh cane juice—3 to 5 ml. is made upto 100 ml. 5 ml. of this solution is freed from proteins and the filtrate made upto 50 ml. To this made up filtrate are added first 4 ml. of sulphanic acid (0.8% containing 1 ml. of concentrated sulphuric acid in 250 ml. of solution) and then 2 ml. of freshly prepared sodium nitrite solution (8.0%). The contents are mixed well and finally 5 ml. of sodium hydroxide solution (10%) is added and mixed. The light orange colour is allowed to develop for 3 minutes and then compared with an artificial standard of potassium permanganate and potassium dichromate mixture. The artificial standard is standardised against a standard solution of phloroglucinol. The weight in milligrams of phloroglucinol representing the phenolic content per 100 ml. of juice divided by the specific gravity of the juice gives the weight of phenols in milligrams per 100 g. of juice.

Phenolic content was determined in juices of six cane varieties, viz., Co. 285, Co. 290, Co. 419, Co. 421, Co. 439 and Co. 467 and six varieties of *Saccharum spontaneum*, viz., Imp. 1182, S.H. 328, SES. 74-A, SES. 45, SES. 327 and SES. 532 kindly made available by the Botanist, Spontaneum Expedition Scheme of this Institute. Four to five fully mature canes in the case of Co. canes and 30 to 40 stalks in the case of spontaneums were taken for obtaining juice samples.

In Table I are given the amounts in milligrams of phenolic substances (in terms of phloroglucinol) on juice weight basis.

It is evident from the data that on the whole the phenolic content of spontaneum juices is higher than that of cultivated canes. Co. 285 shows the highest phenolic content—mean value 102 mg. as compared to the other five varieties where the mean value ranges between 28 mg. and 58 mg. On the other hand, the mean phenolic content of spontaneums ranges between 70 and 139 mg.

TABLE I  
Amount in milligrams of phenols expressed as phloroglucinol per 100 g. of juice

Variety	D <sub>1</sub>		D <sub>2</sub>		Me
	I <sub>1</sub>	I <sub>2</sub>	L <sub>1</sub>	L <sub>2</sub>	
<i>Co. canes</i>					
Co. 285 ..	109	108	102	90	102
Co. 421 ..	56	58	58	60	58
Co. 467 ..	56	55	49	..	53
Co. 419 ..	45	45	45	47	46
Co. 290 ..	35	31	35	32	34
Co. 439 ..	28	30	26	..	28
<i>Spontaneums</i>					
Imp. 1182 ..	129	132	153	140	139
SES. 74-A ..	104	100	110	110	106
S. H. 328 ..	106	108	95	98	102
SES. 45 ..	106	103	104	91	101
SES. 327 ..	71	72	72	66	70
SES. 532 ..	46	44	44	..	45

Using 2 dilutions D<sub>1</sub>, D<sub>2</sub> for each juice and two levels L<sub>1</sub>, L<sub>2</sub> for each dilution and 4 to 6 readings taken in 3 minutes per dilution.

except SES. 532 which contains only 45 mg. The higher phenolic content in spontaneums and Co. 285 is very characteristic and may be of special physiological significance in the hardy and disease-resistant character of these varieties.

Full details of this work will be published elsewhere. Thanks are due to Shri S. Ramakrishnan, Junior Assistant, for assistance and to Shri N. L. Dutt, Director, for kindly affording facilities.

Sugarcane Breeding Inst., K. PARTHASAPATHI,  
Post Lawley Road, M. VIJAYASAKADHY,  
Coimbatore, March 3, 1958.

1. Folin, O. and Denis, W., *J. Biol. Chem.*, 1915, **22**, 305.
2. Scheiner, E., *Biochem. Z.*, 1929, **205**, 245.
3. Hidekatsu Fujiwara and Eiseikataoka, *Z. Physiol. Chem.*, 1933, **216**, 135.
4. Fox, J. J. and Gange, A. J. H., *J. Soc. Chem. Ind.*, 1920, **39**, 269, T.
5. Miller, J. N. and Urbain, O. M., *Ind. Eng. Chem. Anal. Ed.*, 1930, **2**, 123.

#### RESPONSE TO TOUCH STIMULI BY A TENEBRIONID BEETLE, *GONOCEPHALUM DEPRESSUM* K.

A STATE of immobility or death-feigning in response to a sudden and brief stimulus is a known fact in many insects. Such state has been termed thanatosis. Roeder<sup>2</sup> has used the term catalepsy to cover both thanatosis and protective pose. The present note deals with a study of thanatosis in *Gonocephalum depressum*.

sum K. in response to touch stimuli applied with needle and with thread. Besides, stimuli were applied to the different regions of the body to compare the sensitivity of the regions to touch stimuli.

Before application of a stimulus each insect was kept confined to a filter-paper with an inverted funnel for a few hours (4-6 hours). Thus each insect was given a long period of quiet in order to avoid holding or pressing or any other stimulation during application of stimuli. Picking or pressing or dropping has earlier been observed<sup>3, 5</sup> to influence the duration of death-feigning of some insects. The period of thanatosis shown by each individual insect was noted with the help of a stop-watch.

No significant difference has been observed between the responses shown by *G. depressum* to the two different stimuli. Stimuli with thread were not applied to the coxa due to some unavoidable reasons. Responses to stimuli applied with needle to the different regions of the body have been compared. The period of thanatosis in response to touch stimuli to the different regions of the body studied is generally short except that in response to stimuli applied to the coxal segments of legs (Fig. 1),

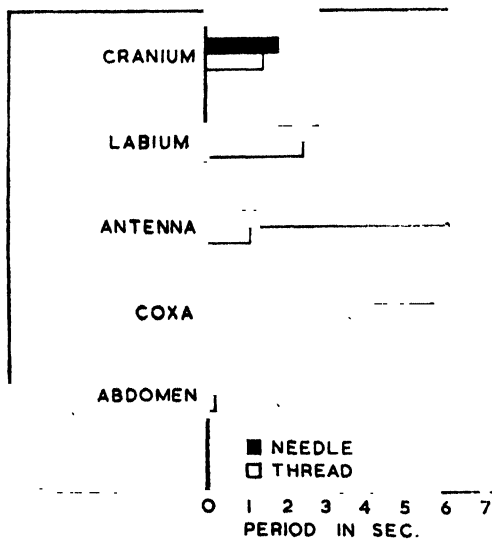

FIG. 1. Response of *Gonocephalum depressum* to stimuli applied with needle or thread to the different regions of the body.

which appear to be the most excitable regions. A longer period of thanatosis was observed when the antennæ were amputated (see Fig. 1, response represented by narrow line against antenna). Rabaud<sup>1</sup> induced tonic immobility

by decapitating a number of Lepidoptera which did not show such response to feeble stimulation. Thanatosis is probably induced more effectively by a stronger stimulus in insects which show little or no thanatosis to a lighter stimulus.

The authors are thankful to Dr. A. P. Kapur, Entology Section, Zoological Survey of India, who kindly identified the species.

Dept. of Zoology, A. K. DATTA GUPTA.  
Birla College, Pilani, B. B. GUPTA.  
May 15, 1957.

1. Rabaud, E., *Bull. Soc. Zool. Fr.*, 1917, **42**, 158-66.
2. Roeder, K., *Insect Physiology*, 1953, 483-85.
3. Weiss, H. B., *J.N.V. ent. Soc.*, 1944, **52**, 281-83.
4. —, *Ibid.*, 1947, **55**, 275.
5. —, *Ibid.*, 1951, **59**, 245.

#### COBALT AND ZINC CONTENTS OF A FEW FORAGE PLANTS OF WESTERN INDIA

THOUGH the exact role of cobalt and zinc in plant nutrition is yet to be confirmed, their importance in animal nutrition is well established. While cobalt is a constituent of vitamin B<sub>12</sub>, zinc has been found to be essential in the utilization of vitamin A, riboflavin, biotin, pantothenic acid and other essential fatty acids. Forage plants are the only source of Co and Zn for livestock requirements. Plants growing on normal soils rarely suffer from zinc deficiency and even under the most deficient conditions in soils, Zn concentration of pasture plants rarely falls below 10 p.p.m.<sup>5</sup> which is enough to meet animal requirements. Cobalt deficiencies, on the other hand, are of more common occurrence and pastures containing less than 0.07 p.p.m. Co induce such diseases as bush sickness, phalaris staggers, salt sickness and other wasting diseases leading to death.<sup>1,3</sup> As information is lacking on the Co and Zn contents of forage plants of Western India, a preliminary survey was carried out to determine the Co and Zn status of important forage plants from the grasslands of Bombay. All plant samples were collected at the flowering stage and the analysis was made on triplicate samples by the methods of Piper.<sup>4</sup>

Table I shows that the Co content of grasses varies from 0.2 to 1.0 p.p.m. with an average of 0.6 p.p.m. while the Zn content varies from 10.73 to 36.19 p.p.m. with an average of 16.93 p.p.m. The legumes, on the other hand, contain slightly higher amounts of Co varying from 0.4 to 1.6 p.p.m. with an average of 0.8 p.p.m. but lesser amounts of Zn, varying

TABLE I  
Average Co and Zn contents of some Indian forage plants (p.p.m. of dry matter)

Botanical Name	Co	Zn
1 <i>Ischæmum ciliare</i> Retz.	.. 0.4	36.19
2 <i>Heteropogon contortus</i> L.	.. 0.6	14.04
3 <i>Themeda triandra</i> Forsk.	.. 0.8	12.01
4 <i>Themeda quadrivalvis</i> OK.	.. 0.7	14.14
5 <i>Pseudanthus heteroclita</i> Ilk.	.. 0.8	13.57
6 <i>Arundinella tenella</i> Lawii	.. 1.0	10.73
7 <i>Dicanthum annulatum</i> Stapf.	.. 0.3	12.54
8 <i>Eulalia fimbriata</i> Bl. & Mc.	.. 0.2	20.21
9 <i>Indigofera tinctoria</i> L.	.. 1.6	8.73
10 <i>Hedylandia latifolia</i> DC.	.. 1.2	4.99
11 <i>Crotolaria imifolia</i> L.	.. 0.4	13.42
12 <i>Crotolaria triquetra</i> Dalz.	.. 0.4	18.41
13 <i>Crotolaria julipes</i> Benth.	.. 0.5	16.38
14 <i>Smutia sensitiva</i> Ait.	.. 0.8	6.71
15 <i>Alysicarpus vaginatus</i> DC.	.. 0.7	5.48
16 <i>Alysicarpus pubescens</i> Law.	.. 0.6	4.60

from 4.60 to 18.41 p.p.m. with an average of 9.84 p.p.m. Our Co values confirm the findings of Datta and Datta Biswas<sup>2</sup> who found 0.10 to 0.60 p.p.m. Co in the young stages of some Indian fodder plants grown under uniform conditions in pot cultures. While there appears to be no deficiency of Co in the pasture species of Western India, the probability of Zn deficiency arising in the mature stages cannot be ruled out, as the Zn content is in marginal amounts in grasses with the exception of *Ischæmum* and *Eulalia* and in deficient amounts in the legumes, excluding species of *Crotolaria*. As soil analysis has shown that the available Zn content of the grassland soils is uniform, plant intake of Zn appears to be more dependent on species than on available Zn. Since the mineral content of pasture plants decreases with age, there is a likelihood of Zn deficiency occurring even in grasses. Therefore, stock requirements of Zn can be met with only if the forage is harvested just after flowering.

Dept. of Botany, (MISS) JAYA G. IYER.  
Institute of Science, Y. SATYANARAYAN.  
Bombay-1, December 23, 1957.

1. Askew, H. O. *New Zealand J. Sci. and Technol.*, 1939, 20 A, 315.
2. Datta, N. P. and Datta Biswas, N. R., *Indian J. Agric. Sci.*, 1950, 21, 93.
3. Mitchell, R. L., *Soil Sci.*, 1945, 60, 63.
4. Piper, C. S., "Soil and Plant Analysis," *Waite Agr. Res. Inst.*, 1944.
5. Underwood, E. J., *Trace Elements in Human and Animal Nutrition*, 1956, Academic Press.

### DETECTION OF MUSTARD OIL IN OTHER EDIBLE OILS

CASES have been encountered where mustard oil was used to adulterate other edible oils. Suspicion would arise from the trend of the usual analytical characteristics. The following test has been devised to confirm the presence of mustard oil; it is based on the detection and estimation of allyl iso-thiocyanate, the volatile constituent present in mustard but not in other edible oils.

The A.O.A.C. method<sup>1</sup> for the determination of volatile oil of mustard was followed with slight modification. In brief the method consists in mixing 10 ml. of the oil with 100 ml. of water for 2 hours, and then adding 20 ml. of alcohol. The mixture is distilled, and 60 ml. of distillate is collected in a flask containing 10 ml. of dilute ammonia (1:2). Twenty ml. of N/10 AgNO<sub>3</sub> are added to the distillate, and after standing overnight to coagulate Ag<sub>2</sub>S, the solution is made up to 100 ml. and filtered. Fifty ml. of filtrate are distinctly acidified with HNO<sub>3</sub> and titrated with N/10 NH<sub>3</sub>CNS using 5 ml. of 10% ferric ammonium sulphate as indicator.

1 ml. N/10 AgNO<sub>3</sub> = 0.004956 g. allyl iso-thiocyanate.

An indication of the presence of mustard oil is obtained even during addition of AgNO<sub>3</sub> solution to the distillate, by immediate formation of a dark colour and black precipitate. With other oils, only a slight brown colour may at worst develop on standing overnight. The intensity of the dark colour and the amount of black precipitate formed are directly related to the amount of mustard oil present.

Some results are summarized in Table I.

		Allyl iso-thiocyanate
Mustard oil No. 1	..	Present (0.38% appx.)
Do. No. 2	..	do (0.19% appx.)
Linseed oil	..	Nil
Niger seed oil	..	do
Cocoonut oil	..	do
Groundnut oil	..	do
Sesame oil	..	do
Linseed oil containing mustard oil No. 1	..	Present (0.05% appx.)
Do. No. 2	..	Present (0.01% appx.)

Work is in progress on the detection of the sulphur in the volatiles of mustard oil by conversion to H<sub>2</sub>S by a simple method.

Central Food Lab., S. N. MITRA.  
Calcutta-16, B. R. ROY.  
March 4, 1958. P. N. SENGUPTA.

1. *Official and Tentative Methods of the Association of Official Agricultural Chemists*, 8th Ed., 1955, p. 517.

---



---

## REVIEWS

---



---

**Solid State Physics.** (*Advances in Research and Applications*, Vol. 3.) Editors: F. Seitz and D. Turnbull. (Academic Press, Inc., New York.) Pp. 588. Price \$12.00.

This is the third volume of the series and it contains six excellent articles on some of the vital problems of Solid State Physics. In reviewing such a book one has to rest content with enumerating the articles and giving the barest summary of each. The topics dealt with are: (i) Group III-Group VI compounds, (ii) The continuum theory of lattice defects, (iii) Order-disorder phenomena in metals, (iv) Phase changes, (v) Relations between concentration and imperfection in crystalline solids, and (vi) Ferromagnetic domains.

To each article is appended an exhaustive list of references which alone would have completely justified the publication of this volume.

It has long been realised that Group II-Group VI compounds like ZnS and Group I-Group VII compounds like CuI possess semiconducting properties. The important set of semiconducting Group III-Group V compounds like Ga-As, In-As, etc., have been investigated only recently and the first article in the book by H. Welker and H. Weiss deals with the physical and chemical properties of such compounds. The electrical, magnetic and optical properties have been dealt with in some detail.

The introduction of an interstitial or impurity atom a vacant site or a dislocation, in general, alters the position of every lattice point and in many cases it is most satisfactory to treat the greater part of the crystal as a continuum. For this, one uses the usual theory of elasticity modified by the presence of internal stresses which have to be considered as being capable of moving about in the medium. Such treatments have been developed as early as 1897 by Burton and by Larmor when the elastic theory of ether was in vogue. This method is found to be extremely useful in treating the modern problems of lattice defects. This has been dealt with in a clear and beautiful manner by J. D. Eshelby in such a way that the reader can grasp some of the important uses as also the disadvantages of this elegant technique.

The order-disorder phenomena in metals, particularly the means of detecting the short-range and long-range "order parameters" form

the topic of the third article by L. Guttman. Particularly valuable are the parts on the statistical thermodynamics of order of alloys and the kinetics of order-disorder transformation. The article concludes with a useful appendix on ideal ordered structures.

The fourth article on phase changes by D. Turnbull aims at elucidating the relative stability of different phases of the same substance and also presents the mechanism of formation of one phase in another. With this view the classical explanation of Gibbs is presented and it is followed by recent theories of phase stability and of the mechanism of phase change.

The next article by F. A. Kroger and H. J. Vink gives the different types of relationship between the concentrations of imperfections so that from such a knowledge one may hope to control and regulate the concentrations of the different imperfections. These authors make use of a novel graphical treatment (in preference to the analytical one) which makes the understanding of this rather complex subject very much easier and which facilitates in the appreciation of the pioneering ideas of Wagner and Schottky.

The last article by C. Kittel and J. K. Galt deals with the various aspects of the ferromagnetic domain theory.

One cannot but be impressed by the thoroughness with which the authors have presented each topic. The editors deserve special congratulations and thanks of all Solid State Physicists on having embarked on the publications of these indispensable volumes. S. R.

---

**Introductory Nuclear Physics.** (Asian Students Second Edition.) By David Halliday. (Publishers: Asia Publishing House, Bombay), 1957. Pp. ix + 493. Price Rs. 17.50.

This edition of the book, styled as Asian Students Edition, is much cheaper than the original, first published in 1950, so as to bring it within the purse of each and every student. Nuclear physics has gained much importance in recent years and many Universities offer this subject as a part of their curriculum. It is imperative, for any one who is pursuing the profession of a physicist to be acquainted with nuclear physics in order to keep himself in touch with this rapidly growing and important subject of fundamental interest. The need for

such contact with this subject is all the more important for the present-day generation of students of physics.

To fulfil this need, the book should start from elementary ideas and lead the reader on to the more advanced ideas on the subject. As the theoretical side of the subject is bound up with much of complicated mathematical apparatus, it would be bewildering to the student to give anything more than the necessary dosage of this. The experimental aspect of the subject should be stressed and only such theoretical ideas that would be helpful in understanding the significance of the experiments should be introduced. In the present book, such a line has been adopted and a compromising synthesis has been brought out. Its experimental bias makes it the ideal one for the non-specialists to appreciate and understand the subject. The treatment covers all the major topics including such aspects as fundamental particle physics, cosmic rays, nuclear spin and magnetism, electric quadrupole moments, nuclear fission and nuclear reactions. Thirteen appendices elaborate certain points of interest at the end.

It is a book which in the opinion of the reviewer can be warmly recommended to persons who are non-specialists in the subject, but who want to understand something of this complex subject.

---

**Neutron Cross Sections.** By Donald J. Hughes. (International Series of Monographs on Nuclear Energy, Division II, Volume I.) (Pergamon Press, London, New York, Paris), 1957. Pp. 182. Price 30 sh.

This monograph is essentially meant for those non-specialists in nuclear physics, who still intend to interpret and use the available experimental data on neutron cross-sections, as compiled and published by the Brookhaven National Laboratory and others.

Any intelligent understanding and use of such data is considerably complicated by the great variety of the observed neutron cross-sections and their rather unsystematic nomenclature. The available experimental data on neutron cross-sections is now so vast and the experimental techniques so various, that it is rather difficult to keep an overall picture of the present state of development of the subject. Chapter I removes both these difficulties quite satisfactorily.

A proper appreciation of the available experimental data requires that these neutron cross-sections must be related to the nuclear structure. However, the conceptual nuclear

structure has been considerably modified by the recent successes of the nuclear optical model and the nuclear shell model. Chapter II quite simply deals with this situation in connection with neutron cross-sections.

The last four chapters deal with the specific techniques for measurement of neutron cross-sections and the nature of results obtained by them. Chapter III specifically deals with fast neutrons. Chapters IV and V deal with resonance neutrons interacting with non-fissionable and fissionable nuclei respectively. Chapter VI deals exclusively with the interactions produced by thermal neutrons.

This monograph is very clear, concise and easy to read. It is excellent as an introduction to this subject. It will certainly enable one, without prior specialisation in nuclear physics, to use intelligently the available experimental data on neutron cross-sections.

K. M. G.

---

**Methods of Biochemical Analysis, Vol. V.** Edited by David Glick. (Interscience Publishers, Inc., New York; India: Asia Publishing House, Bombay-1), 1957. Pp. ix + 502. Price \$ 9.50.

This book which is the fifth volume of annual series on "Methods of Biochemical Analysis", comprising methods, procedures and techniques for the determination and assay of biologically important substances maintains the high standard set by the previous volumes. The editor states in the preface, "The general plan followed in the organisation of the individual chapters is a discussion of the background and previous work, a critical evaluation of the various approaches, and a presentation of the procedural details of the method or methods recommended by the author. The presentation of the experimental details is to be given in a manner that will furnish the laboratory worker with a complete information required to carry out the analysis". This aim has been amply achieved in this book.

The topics discussed relate to assay methods for choline esterases, biological standards in biochemical analysis,  $\alpha$ -keto acid determinations, microdetermination of cobalt in biological materials. Activation analysis and its application in biochemistry, contamination of trace element analysis and its control, chemical determination of estrogens in human urine and infra-red analysis of vitamins, hormones and coenzymes. A cumulative index for Volumes I-V is provided in this volume.

In each case the treatment starts with introduction, general principles involved in the preparation of samples for analysis and the description of various methods and techniques employed in the determination. The reader can appreciate more clearly some of the difficulties involved in the problems and at the same time provide with useful practical information. The treatment of each topic by the author, who is a specialist, is simple and clear. The present volume achieves so useful a level of competence and value that no biochemist interested in the topics discussed in the volume should be without it. The book is well printed on good quality paper, is attractively bound and is free from printing errors. The editor and the authors are to be heartily congratulated upon the production of this volume, and the series constitutes a most notable contribution to biochemical analysis.

K. V. GIRI.

**Sulphonamides—Second Conference.** (*Annals of the New York Academy of Sciences*). Vol. 69, Art. 3, 1957. Pp. 377-564. Price \$3.00.

This is a monograph on the sulphonamides comprising of 17 articles by 32 authors (predominantly American) including such authorities on the subject as G. Domagk, P. H. Long, D. Lehr, M. H. Lepper, M. Finland, M. Hamburger and A. M. Rutenburg. The first article is by Gerhard Domagk who was awarded the Nobel Prize in Medicine in 1938 for his discovery of the chemotherapeutic value of prontosil. In this article after summarizing the use the sulphonamides have been put to during the last quarter century, he gives reasons for the recent renewed interest in these antibacterial agents. This is followed by 8 articles on the value of the currently used sulphonamides in clinical practice, including an excellent one on the toxicity of these drugs by Lehr, wherein he restates his arguments for the use of sulphonamide mixtures. The rest of the publication (8 articles) deals with two new sulphonamides—Sulfachloropyridazine and Sulfamethoxy pyridazine. These articles comprise of reports on therapeutic trials of these drugs both in experimental animals and in clinical cases of bacterial infection. The chief advantage of one of them (sulfamethoxy pyridazine) over the current sulphonamides seems to be its prolonged action in the body by virtue of its slow elimination by the kidney (p. 450). This means that the drug could be given at longer intervals both in infections susceptible to sulphon-

amides (single daily dosage, p. 507), and in the prevention of streptococcal infections in rheumatic patients (once or twice a week, p. 491). There are some repetitions but this is inevitable in a publication of this type.

This is a timely publication when the newer antibiotics are overshadowing the sulphonamides and obscuring their real value. The sulphonamides are cheap (a consideration of great importance in this country) and are now relatively non-toxic. Clinicians, pharmacologists, and biochemists interested in the subject, will find it well worth their while to read this monograph.

S. C. DEVADATTA.

**Rice in India.** By R. L. M. Ghose, M. B. Ghatge and V. Subrahmanyam. (Indian Council of Agricultural Research, New Delhi.) Pp. x + 507. Price Rs. 21.

The Indian Council of Agricultural Research has an ambitious programme of bringing out a series of monographs on the various crops of India, and the present volume, the first in the series, deals with rice, the most important food crop of the country. The publication is a critical compendium of information on research work done in the country up to the end of 1956. The book has three parts dealing respectively with Agriculture, Marketing and Technology, and each of these parts has been handled by a most competent authority on the subject.

Part I, covering nearly three-fourths of the volume, deals with Agriculture and has 21 chapters, the first eight on general problems, the next nine on different aspects of research in the crop and the last four on the most important aspects of extension work. This part also has 5 Appendices giving valuable information on climatic conditions, list and distribution of various rice pests and diseases, green manuring practices and crops used for green manuring and an up-to-date list of improved strains evolved by breeding. The chapters on genetics and cytology are only brief summaries of work done on these subjects in India, but they make a substantial contribution to our present knowledge of them. The large chapter on Agronomy, in its restricted meaning, summarises the information on results of extensive experiments on manures and fertilisers conducted in the different States of India. Some information is also provided on the special features of nitrogen and phosphate utilisation in water-logged soils. The limited information on crop sampling, plant correlations, field plot

techniques, etc., that has come out mostly from work at the Central Rice Research Institute is also included. Chapters 7 and 8 in the general section deal respectively with diseases and pests and so also Chapters 16 and 17 in the Section dealing with research. The contents of the chapters differ and there is no repetition of information as the chapter headings would appear to indicate. Perhaps the contents of Chapters 7 and 8 could have been summarised and included along with Chapters 16 and 17. The Section on extension has four useful chapters dealing respectively with seed multiplication and distribution, production and distribution of fertilisers, organisation of plant protection and Japanese method of rice cultivation as adapted and practised in India.

Part II deals with Marketing of Rice in India and has ten chapters giving information on various aspects including protection, share of production coming for marketing, wholesale and retail prices, classification, grading and standardisation, etc. It is said that only 50-60% of the price paid by the consumer goes to the producer, and mention is made of the steps that are being taken to increase the share of the producer. It may be said that in no other rice-growing country of Asia, except perhaps Japan, such detailed information on rice marketing has been collected as in India.

Part III dealing with technology provides information on technology of rice processing, nutritive value of rice and rice diets and their nutritional improvement. Results of research done at the Central Food Technological Research Institute, Mysore, on preparation of nutritionally rich foods are included in this Part.

This is the first time an authoritative publication of scientific work done on an important agricultural crop has been made available to the public in India and elsewhere. The authors of the book have done a splendid job and research workers and students in India have now a valuable reference publication available to them. The book though it incorporates valuable research on certain aspects, information on other aspects is sketchy and needs more work. Investigations that should prove particularly valuable refer to the determination of linkage groups, the nutrition of the rice plant, the chemistry of water-logged soils and a better understanding of the soil-water-plant relationship. These studies are receiving greater attention in Japan and U.S.A.

The Indian Council of Agricultural Research can be congratulated on the excellent get-up of the publication with a number of charts and

illustrations and it differs in this respect from some of their earlier publications. The larger volume of work devoted to rice and the availability of publications recording the results of such work has no doubt facilitated the preparation of this publication, and we may confidently look forward to similar books on other important crops. The value of the book would have been enhanced by a suitable index which is not there now, and we hope this defect will be remedied in the revision of the present edition which we understand is in progress as the first printing has already been sold out.

K. R.

**Discovery Reports—Sperm Whales of the Azores.** Vol. 28. By Robert Clarke. (Cambridge University Press, London, N.W. 1), 1956. Pp. 237-98. Price £ 27 6d.

The report under review well illustrates the amount of data, the careful analysis and the cautious generalisations which lie behind each statement appearing in scientific text-books. For example, this entire report may be summarised in text-books as a short paragraph "The males live for 32 years and grow to a length of 59 ft. while females die after 22 years attaining a length of about 55 ft. Whales mature when they are 26-41 ft. long. Breeding is seasonal and young ones are born usually between July and August. The period of pregnancy extends to 16 months and the mothers nurse the young for 13 months. The female sexual cycle lasts about 3 years. The first teeth are cut when the young are about 21 ft. long; subsequent teeth may erupt in the middle of a row. The number of teeth may vary, independent of age. Females are usually in group whereas some males are solitary. During migration the males arrive first." But only when students read reports like the present, they will understand the wealth of observations and measurements and dry statistical analysis from which these facts are extracted.

C. P. G.

**The Mango.** By S. R. Gangolly, Ranjit Singh, S. L. Katyul and Daljit Singh. (Indian Council of Agricultural Research, New Delhi), 1957. Pp. xiii + 530. Price Rs. 40.

This illustrated monograph entitled *The Mango* constitutes a welcome addition to the relatively meagre literature available on this leading fruit of India. It presents the results of a descriptive study of the more important mango varieties of this country carried out under an I.C.A.R. scheme initiated in 1948.



The monograph is divided into two parts. Part I deals with the mango varieties. After a short introduction to the romantic legends associated with the occurrence, use and nomenclature of mangoes in India, the authors outline briefly a taxonomic description of the mango and the limited cytogenetical investigation carried out in relation to it. This is followed by detailed descriptions and coloured illustrations of 210 leading mango varieties selected from different parts of India. The authors have adopted the descriptive terminology and the methods of selection of specimens employed by Naik and Gangolly (1950) in their study of the South Indian mangoes. It is well known that in mango varieties the qualitative characters such as the shape of the fruit and leaves are relatively more constant than quantitative characters such as their size and weight which may vary under changing environments. This fact, coupled with absence of any adequate pedigree records in regard to most of the varieties, and the fanciful practice of giving arbitrarily different names to the same variety (or *vice versa*) in different localities, greatly complicates the problem of straightening out the present chaos that prevails in the matter of taxonomy and nomenclature of the mango varieties of this country. The present monograph serves more to underline this problem rather than solve it. The lack of a comparative key to the identification of the different varieties considered here impairs the practical utility of this monograph beyond confirming the identity of a known variety by comparison with the given description, data and the coloured illustration. The coloured illustrations, however, are often unnatural in regard to hue, there being a predominance of orange colour in almost all the mangoes illustrated.

Part II of this Monograph outlines the techniques and problems of mango cultivation, giving information of practical interest to growers. In the first chapter, after a brief reference to the distribution and acreage under mango cultivation in the various parts of India, and the climate and soil conditions favouring it, the authors describe concisely some of the more modern methods of mango propagation, culture and harvesting. They also briefly discuss here the irregular bearing of mango varieties, a problem of considerable commercial importance. Leading insect pests and diseases of mango and methods of their control where known are discussed in a separate chapter which, however, suffers from certain deficiencies inherent in the condensed treatment of a

rather specialised and complex subject. Certain diseases, for example, mango malformation and black-tip are not satisfactorily dealt with in regard to their symptoms and etiology and, in fact, some aspects of these need to be modified in the light of more recent research.

The Monograph on the whole is well produced and will be of help as a reference book to mango connoisseurs, growers and scientists. It may be hoped that this compilation would also stimulate the production of much-needed technical monographs on other commercial fruits of this country. S. N. D. G.

---

**Advances in Pest Control Research, Vol. I.** By R. L. Metcalf, Citrus Experiment Station, University of California, Riverside Calif., U.S.A. (Interscience Publishers, New York and London), 1957. Pp. vii + 514. Price \$ 11.00.

Research on pest control has increased so tremendously in recent years in all countries that it has been difficult to keep track of the subject. This book would, therefore, be welcomed by one and all, whether he is a research student, a field worker or a teacher. As a work of reference, it gives the latest position of our knowledge on pesticides and contributors to the volume are every one of them specialists on the particular subject they have dealt with and this has undoubtedly increased the value of the book.

With the advent of modern synthetic pesticides, health hazards in their use have been giving great anxiety to the public in most countries and engaging even the attention of international organisations. It is, therefore, only appropriate that the publication should commence with a treatise on the most important subject, "The control of health hazards associated with the use of pesticides". There can be no better author to review this subject than J. M. Barnes, who made a general survey of health hazards with the use of pesticides in 1952, on behalf of the W.H.O.

Our present knowledge of the chemistry and mode of action of herbicides has been ably dealt with by A. S. Crafts. This author has admitted that there is need for knowing more of the biochemistry and physiology of herbicides. It is hoped that scientists working on them would pay more attention to these lacunæ existing in our information.

The use of organic phosphorus insecticides in insect control has been considerably increased in recent years in spite of their high mammalian toxicity. The fundamental aspects of che-

mistry and action of organic phosphorus insecticides discussed therefore by T. R. Fukuto are of very great value to those who use them and want to have a more precise knowledge of this subject. He has shown that high anti-cholinesterase activity is not an essential prerequisite in these compounds for high insecticidal activity. In synthesising these compounds, it would be useful, therefore, if chemists try and produce those which are more specific to insects and are less dangerous to mammals.

J. G. Horsfall has treated the general subject of mechanisms of fungitoxicity in such a way as to be understood by even laymen. Furthermore, the discussion is interspersed with humorous remarks which makes the review very enlightening.

Control of plant diseases caused by fungi living in soil has always been a difficult problem. J. B. Kendrick, Jr., and G. A. Zentmyer have dealt this subject in all its aspects and summarized our present knowledge of chemical control, physical control, biological control, development of disease resistance as well as the important plant quarantine subject of regulatory control of soil fungi. One cannot expect a better presentation of the matter than what has been attempted by the authors.

The use of Repellents against insects and other Arthropods has gained in importance, particularly during the Second World War and afterwards, and much work has been done during the last few years. That this subject should also receive a place in this review is not surprising. The masterly review on the Repellents for Biting Arthropods by G. F. Shambaugh, R. F. Brown and J. J. Pratt, Jr., cannot but be commended.

The use of systemic organo-phosphorus insecticides has progressed considerably during the last few years in spite of their high toxicity to mammals because it has been shown that with thorough precautionary measures, it is possible to avoid hazards of application. Dr. W. E. Ripper, one of the foremost authorities on systemic insecticides, has given an excellent and critical review of the status of these insecticides in pest control practices. The methods of applying these insecticides, such as, Foliar sprays, bark application, soil treatment as well as trunk implantation and seed treatment and their relative importance have been exhaustively dealt with by him. The author has concluded his review with a brief account of selectivity of the systemic insecticides and the integration of biological and chemical methods of control. More work on this subject is necessary, and as the author himself states,

a much greater effort to find more selective systemic insecticides is warranted.

The increased use of pesticides in recent years has brought in its wake problems relating to their residues. M. S. Schechter and I. Hornstein's review of "Chemical Analysis of Pesticide Residues", and Dr. Yun-Pei Sun's "Methods of Bioassay of Pesticide Residues", are, therefore, of very great use to all dealing with pesticides. The table indicating range of tolerance of residues of insecticides included by the former authors would come in very handy for reference.

To maintain a safety record, besides educating the public in the proper use of pesticides in most advanced countries, Pesticides Acts have been enacted so as to regulate the import, manufacture or sale of pesticides. Schechter and Hornstein, in their introduction to the review on analysis of pesticide residues, have shown the importance of such Acts. The reviewer had an opportunity some years ago to draft a Pesticides Act for this country, but for some reason or the other, it does not seem to have been enacted. With more and more poisonous and new insecticides introduced in the market, particularly in a country like India, there is great need for early legislation to regulate the import, manufacture and sale of pesticides, as well as for setting tolerances for residues of pesticides on various crops. On account of the important problem of pest residues in food, there is also need for legislation as regards their permitted levels. As stated by J. M. Barnes in his review on control of health hazards, this should be simultaneously accompanied by an effective service for analyzing food for pesticide residues.

In conclusion, the editor, Prof. R. L. Metcalf, as well as the Interscience Publishers, Inc., have to be congratulated for publishing this authoritative and most useful book.

V. P. R.

#### Books Received

*Carnegie Institution of Washington Year-Book, 1956-57*, No. 56. (Carnegie Institution of Washington, 1530 P St., Northwest Washington 5, D.C.), 1958. Pp. xliii + 425. Price \$ 1.50.

*Safety Techniques for Radioactive Tracers*. By J. C. Bournsell. (Cambridge University Press, London N.W. 1), 1958. Pp. xi + 68. Price 7 sh. 6 d.

*The Sources of Invention*. By J. Jewkes, D. Sawers and R. Stillerman. (Macmillan & Co., St. Martin Street, London W.C. 2), 1958. Pp. xv + 428. Price 31 sh. 6 d.

---



---

## SCIENCE NOTES AND NEWS

---



---

### Synthetic Diamonds

In a preliminary statement (a letter to *Nature*, 1958, 181, 758), Prof. Lonsdale and Dr. Grenville-Wells report that 10 representative specimens selected by them have been studied to date. In every case these laboratory-made diamonds showed one outstanding diffraction feature, namely, the presence of a comparatively strong (200) reflexion, which is never shown by any natural diamond, whether of terrestrial or meteorite origin. Other 'forbidden' reflexions were also present.

Prof. Lonsdale and her co-worker say that the apparent explanation is that each diamond consists of a matrix of a normal diamond with the carbon atoms in their usual positions and spacings, but that within this matrix there are islands of a different structure with a lattice constant or spacing close to that of diamond but different from it.

Spectroscopic analysis of the diamonds carried out by Johnson Matthey's research laboratories has demonstrated the presence of some 0.2% of nickel. The presence of the nickel 'points to a probable explanation of the subsidiary structure' for, nickel does not normally appear as an impurity in natural diamonds. The closeness of its lattice constant to that of diamond indicates that it might be a possible inducer of crystallization of carbon in the diamond form. It is suggested that the process of cooling from high temperatures and simultaneously expanding it from high pressures, could well leave islands of face-centred cubic nickel of  $Ni_3C$  or some other nickel compound in a state of strain.

### New Oestrogenic Hormone Isolated from Clover

A New Oestrogen—a type of hormone regulating specific growth activities—has been isolated from Ladino clover and its structure has been determined by scientists of the U.S. Department of Agriculture. This potentially valuable oestrogen—named coumæstrol—is also present in lucerne and strawberry clover.

Research workers at the USDA's Western Utilisation Research and Development Division, Albany, California, report that coumæstrol is different in chemical structure from other known animal and plant oestrogens. Although oestrogenic compounds are known to

be active in about 40 plants, only a handful of these hormones have been isolated.

Coumæstrol, a crystalline substance, about 30 times more active than genistein, is one of the most potent oestrogens in forage crops. It is less powerful in its effects on animals than stilbæstrol.

Oestrogenic activity interfered dramatically with normal fertility among sheeps in Western Australia during the 1940's. Cause of this decline in fertility was at first not understood, but was later traced to excess intake of clover oestrogen. This was due to war-time shortages of fertilisers and bulk feeds, and scanty rainfall, causing a greater than normal consumption of clover for a long period of the time in that country.

Plant oestrogens are just beginning to be studied systematically. Recent work at Indiana, U.S. Agricultural Experiment Station, has shown wide variations in oestrogen concentrations in lucerne during the growing season. Work also showed lucerne leaves have more oestrogen than the flowers and flowers more than the stem. Lucerne silage made with blackstrap molasses contains more oestrogen than lucerne in pasture or lucerne ensiled without the molasses.

### A Third Atomic Reactor for India

India's third atomic reactor is expected to go into operation during 1958-59. Known as "Zerlina" it will assist scientists and engineers doing research work on new designs for atomic reactors.

The first Indian reactor, "Apsara", started functioning in 1956. It is being used for research in neutron physics and production of isotopes. A second reactor, which will probably be in operation by the end of this year, is being set up in co-operation with the Canadian Government under the Colombo Plan. It will enable experiments to be made on the conversion of thorium into fissile uranium.—UNESCO.

### Antidote to Strontium

The discovery of a new chemical substance which it is claimed, checks and eliminates the effects of strontium in the human body has been announced at a Meeting of the American Chemical Society in San Francisco.

According to Dr. Arthur Lindenbaum, of the Argonne National Laboratory in Illinois, it is a tasteless yellow dye called rhodizonate. It might lead to the development of a series of chemical compounds which would cleanse human and animal bodies of other radioactive substances. Rhodizonate is said to act by attaching itself to strontium atoms in the body, and forming an insoluble compound, which is eliminated from the system as waste matter.

#### A Camera that Locates Radioactivity

A camera, able to locate any source of radioactive contamination in areas that are too "hot" for radiation-detection instruments, has been developed in the United States. This pin-hole camera, which is about the shape and size of an ordinary box camera, is made of lead and uranium, and weighs 29 lb. It has a uranium lens barrel and a 0.0135" pinhole and makes both conventional and X-ray pictures.

Aimed toward the contaminated area, the camera simultaneously takes a picture on conventional film and records radiation on X-ray film. When the X-ray film is superimposed on the conventional film, the source of radiation is quickly pin-pointed.

The photographic record is made in minutes—a task requiring days of painstaking work, with even the most effective radiation detection instruments. The camera, now in use at the Knolls Atomic Power Laboratory, Schenectady, New York, was designed by an engineer, at the General Electric Company.

#### Rocket Lifts One-and-a-half Ton 'Laboratory' Nearly Three Hundred Miles

On February 21, a single-stage geophysical rocket was launched under the I.G.Y. programme from the middle latitudes of the European part of the U.S.S.R. The rocket reached a record height of 473 kilometres. It was equipped with geophysical instruments for complex investigation of the upper layers of the atmosphere. The total weight of the geophysical scientific instruments, radio-telemetering devices, power sources and auxiliary systems, together with the instrument container which went up with the rocket, was 1,520 kg. (about 3,345 lb., or nearly 1½ tons).

The following geophysical instruments were installed in the rocket:

(1) An ultra-short wave dispersion radio interferometer for measuring free electron concentration in the ionosphere; (2) An instrument to measure the ionic composition of the

atmosphere; (3) Instruments for measuring the concentration of positive ions in the atmosphere; (4) Ionisation and magnetic gauges for measuring atmospheric pressure; (5) An instrument for measuring electronic temperature; (6) Instruments for recording collisions with micrometeoritic particles; (7) A solar spectrograph for recording the ultra-violet region of the spectrum. •

The use of rockets which take up instruments into the ionosphere allows for new research methods which are inaccessible to research workers, based on earth. Studies between 200 and 250 kilometres have materially altered our conceptions of the structure of the ionosphere at these heights.

#### New Economic Process for Separation of Uranium, Thorium and Rare Earths

Uranium, thorium and rare earths in high yields and high purity are claimed to be obtained using a process developed at Ames Laboratory, Iowa State College, U.S. According to a report given to the 133rd ACS National Meeting held recently, almost all thorium present in monazite ores, together with about 98% of the cerium and about 90% of uranium is separated. Thorium is stated to have no uranium in it; the uranium is free of cationic impurities; and cerium is separated from the other rare earths.

An outline of the process is as follows: The monazite ore is concentrated and crushed to particles finer than 65 mesh. This crushed ore is then digested in 93% sulphuric acid at 210° C. for 4 hrs. It is then diluted with water, part decanted and the sludge and undigested sand filtered off. The digested material is diluted still further, adjusted to pH 1.5 and rare earths and thorium are precipitated with sodium oxalate. The uranium remains in solution and is recovered using a strongly basic anion exchange resin. The oxalate cake is taken up in hot caustic, freeing the oxalate for recycle and converting rare earths and thorium to their hydroxides. As 95% of the oxalate is recycled, the process should prove an economic one.

The hydroxides are calcined to remove residual oxalate and to oxidise cerium to the +4 state, and then dissolved in nitric acid from which cerium and thorium are extracted with tributyl phosphate. The cerium is then reduced with sodium nitrite, and cerous cerium goes into the stripping solution. Thorium is removed from the tributyl phosphate by a water strip and the thorium precipitated with oxalic acid.

### Symposium on Vegetable Oils and Their Products

A Symposium on Vegetable Oils and Their Products will be held under the auspices of the National Institute of Sciences of India in October 1958, in New Delhi. The scope of the Symposium will be as follows: (1) (a) Importance of vegetable oils in Indian economy, (b) General survey on the occurrence, production, distribution and consumption of vegetable oils. (2) Applications of edible as well as non-edible oils. (3) Scope for newer and better utilization of non-edible oils and their products. (4) Improvement in production methods: milling, solvent extraction, refining, bleaching, hydrogenation, etc. (5) Physiology and biochemistry: Fat in nutrition, absorption, metabolism. (6) Chemistry of fats and oils, (7) Testing and analysis of oils and oil products. (8) Equipments, and mechanical devices.

Those desirous of participating in the Symposium may send their papers along with abstracts of about 200 words to the Convener, Dr. U. P. Basu, Bengal Immunity Research Institute, 39, Lower Circular Road, Calcutta-16, so as to reach him by July 31st 1958.

### Astronomers' Congress

The Tenth Congress of the International Astronomical Union will be held in Moscow this August. One symposium will discuss the rotation of the earth and the atomic standards of time; another the results of research work on the connection between luminosity and surface temperature in stars.

### Second Geneva Conference on Peaceful Uses of Atomic Energy

The Second International Conference on the Peaceful Uses of Atomic Energy is to be held in Geneva during September 1-13, 1958, under the auspices of the United Nations. The President of the Conference is to be Prof. F. Perrin, of the Commissariat a l'Energie Atomique de France, and the Secretary-General, Dr. S. Eklund, of Sweden. Two atomic energy exhibitions will be held in Geneva during the Conference. The first will be a scientific exhibition under the auspices of the United Nations,

at the Palais des Nations. The other exhibition, which will be commercial, is the International Exhibition on the Peaceful Uses of Atomic Energy, at the Palais des Expositions.

### Conference on High Energy Nuclear Physics

More than 200 scientists from twenty-six nations have been invited to participate in the 1958 Annual International Conference on High Energy Physics, organized by the European Organization for Nuclear Research (CERN), in Geneva during June 30-July 5. Participation at the 1958 Conference is by invitation only. During ten plenary sessions in the auditorium of the Physics Institute of the University of Geneva, papers will be presented on nucleon structure; the nucleon and its interactions with pions, photons, nucleons and anti-nucleons; fundamental theoretical ideas; strange particle production and interaction; invariance principles and selection rules, and weak interactions. The Conference Proceedings, including original papers presented, will be published by CERN

### Lady Tata Memorial Trust Scholarships and Grants for the Year 1958-59

The Trustees of the Lady Tata Memorial Trust announce on the death anniversary of Lady Meherbai Dorabji Tata, 18th June 1958, the awards of scholarships and grants for the year 1958-59.

International awards of varying amounts (totalling £ 5,080) for research in diseases of the blood with special reference to Leucæmias are made to Doctors M. Seligmann (France), M. Simonsen (Denmark), A. J. Therkelsen (Denmark), B. G. Thorell (Sweden), M. Bessis (France), G. Klein (Sweden), Mr. A. Pillai (Switzerland), Dr. J. Ponten (Sweden).

Indian Scholarships of Rs. 250 per month each for one year for scientific investigations having a bearing on the alleviation of human suffering from disease are awarded to: Dr. (Miss) Habib Bano (Lucknow), Dr. (Miss) Satwant Kaur Sokhi (Madras), Miss M. H. Gandhi (Bombay), Mr. P. Suryanarayana Murthy (Bangalore), Dr. Inder Perakash (Lucknow), Miss S. Saroja (Bombay) and Mr. N. L. Tikotkar (Bombay).

593-58. Printed at The Bangalore Press, Bangalore City, by C. Vasudeva Rao, Superintendent, and Published by A. V. Telang, M.A., for the Current Science Association, Bangalore.

All material intended for publication and books for review should be addressed to the Editor, *Current Science*, Raman Research Institute, Bangalore-6.

Business correspondence, remittances, subscriptions, advertisements, exchange journals, etc., should be addressed to the Manager, Current Science Association, Raman Research Institute, Bangalore-6.

#### ANNUAL SUBSCRIPTION

India : Rs. 8-00. Foreign : £ 0-16-0. \$ 2.50.

## PHYSICAL CONDITIONS IN SPACE

**W**HAT is it like in space? One of the main purposes of rocket research is to answer this question. Because of the thin protecting sheath of the atmosphere, conditions at the surface of the Earth have little resemblance to the inhospitable regions which commence only 30 or 40 miles above. These are the realms of the rocket—the beginning of space. It is a frontier full of activity and of interest, and one that is being penetrated deeper and deeper in the effort to extend our knowledge and understanding of the universe we live in.

At first, the atmosphere falls in density by a factor of about ten for every ten miles of ascent. But at a height of some 60 miles, the rate at which the density decreases begins to lessen, and the composition of the atmosphere begins to change rapidly as the action of the Sun's rays becomes more and more significant.

At a distance of several thousand miles, the atmosphere becomes almost indistinguishable from surrounding space. Here the solar and cosmic streams pass in undiminished intensity and together with the meteors constitute the most important factors in the environment.

The electrical and chemical activity of the upper atmosphere and interplanetary space is chiefly due to four kinds of energetic stream. First there is electromagnetic radiation—mainly X-rays and ultra-violet rays from the Sun; secondly, the Sun also emits streams of protons and electrons; thirdly, there are meteors; and finally cosmic rays.

In addition, electric and magnetic fields due to celestial bodies or to the movements of charged particles play their part, and of course, there are the gravitational fields of the Sun, planets and other bodies.

The commonest element in the universe is hydrogen. The Sun and the stars are largely made of it and it is everywhere in space. We expect to find at least 100 atoms in every cubic inch, but there might be far more, possibly 10,000. In any case, it will not be hydrogen as we are familiar with. It will be present in the atomic form, individual hydrogen atoms instead of pairs joined together to form molecules. Indeed, it may be still further dissociated, under the influence of the solar radiation, into protons and electrons.

Then there are the meteors, ranging in size from a few hundred-thousandths of an inch in diameter to boulders approaching asteroidal dimensions. Of course, the larger particles are extremely rare. In a hundred mile cube there

is about one chance in ten of finding at any moment a particle big enough to give rise to a shooting star, even though on entering the Earth's atmosphere a speck the size of a pin's head would become visible to the naked eye.

How hot is it in space? This is the next question that comes to mind and it is a difficult one to answer, partly because we do not know and partly because the question is more involved than it appears. If we take a thermometer and hang it in a room, away from the fire it will give us the air temperature. If we blacken the bulb and put it in the midday sun, it will read a rather high temperature which does not correspond to anything very exactly, but has something to do with the intensity of the solar radiation. If we wrap the bulb in polished zinc it will read still higher. If we paint it white it will read less.

The same kind of thing is true in interplanetary space. A rocket or satellite will take up a temperature, dependent upon the nature of its surface, and having virtually nothing to do with the temperature of the surrounding gas. The temperature of the gas which is really a measure of the velocities of the atoms, may be quite cool or it may be 10,000° C. Again we do not know. It depends on the intensity of the solar radiation in the unexplored very short ultra-violet part of the spectrum.

Among the least inviting aspects of interplanetary space are the solar and cosmic rays. The Sun's chromosphere emits ultra-violet light having a most deleterious effect on organic materials such as rubber, to say nothing of living organisms. In addition the corona emits intense soft X-radiation.

From disturbed regions on the Sun, streams of charged particles, protons and electrons are shot out and it is these which after deflection in the Earth's magnetic field give us the auroræ and magnetic storms which we associate with solar disturbances.

Solar rays and corpuscles and meteoric particles could have a damaging effect on satellite surfaces and especially on the windows of solar batteries and of radiation detectors, but protection could be provided and for a limited time effects would be small.

Cosmic rays, however, present quite another problem. These are the most energetic of the fundamental phenomena of nature. Mostly, they consist of protons with energies up to a million million million electron volts but there are also heavier particles. They all have an

immense penetrating power and the heavy particles produce intense ionization along their tracks. This is because, being stripped of their electrons, they carry a high charge. In some physical experiments the effect of cosmic rays present an appreciable disturbance, but it is generally possible to correct for this. The chief interest in the heavier particles concerns their damaging effect on living tissues.

A start on the solution of many of the prob-

lems of interplanetary space is being made with the present series of satellite launchings. For most of these studies a deep penetration is not required, and many of them only require altitudes up to a few Earth radii.

It seems certain, therefore, that the problems of interplanetary space should soon be yielding to an invasion of that territory, not by men or dogs, but by well-instrumented satellites.

### RECENT DEVELOPMENTS IN ION-EXCHANGE

ONE of the most interesting developments in the field of ion-exchange during the past few years has been the return of interest in inorganic ion-exchangers.

The materials which have been investigated are not the natural or the more recent synthetic zeolites but comparatively simple metal oxides and salts. Precipitates of hydrated oxides such as aluminium hydroxide can behave as either cation or anion exchangers, and the effect has been observed with such metals as zirconium, uranium, thorium and tin.

When zirconyl nitrate, for example, is treated with alkali, the resulting precipitate has an open gel structure cross-linked with -Zr-O-Zr-O- bridges and containing free hydroxyl groups. Such precipitates may be treated with acids such as phosphoric, arsenic or tungstic acids to yield very insoluble products which are stable to high temperatures and contain groups such as the  $H_2PO_4$  group in addition to the hydroxyl group, and which therefore have both anion and cation exchange properties. These materials behave differently at different pH values. These new ion-exchange materials are particularly suitable for the analysis and separation of the alkali metals.

The tedious nature of chromatography upon ion-exchange resins with the necessity of developing specific or selective eluting agents has led to an interest in the production of ion-exchange materials containing functional groups which might be hoped to react in a specific manner. The first attempt to prepare a resin with selective chelating properties involved the preparation of a polystyrene containing di-picrylamine groups and this was shown to have a greater affinity for potassium than the conventional resins containing carboxyl or sulphonic acid groups, as would be expected from the insolubility of the potassium salt of di-picrylamine.

A further development of the ion-exchange technique has been the production of ion-exchange papers. Ion-exchange properties may be conferred upon filter-paper by the introduction of active functional groups into the cellulose structure. Such groups have included the sulphonic and carboxylic acid, the quaternary ammonium' and the phosphoric acid groups.

Ion-exchange materials in the form of membranes permeable to water have also interesting properties and uses. The anion exchanger is permeable only to anions and the cation exchanger is permeable only to cations, while both have a low electric resistance. With such membranes replacing the conventional semi-permeable membranes, the process of electro-dialysis becomes much more efficient and can be used for the desalting of solutions of amino acids such as are obtained in the hydrolysis of proteins. Another use of these membranes is in the determination of the activities of ions and this facility is valuable for ions for which reversible electrodes are not available. These include fluoride, nitrate and acetate.

Protein mixtures have been successively separated upon columns of ion-exchangers but because of the large molecular size of the proteins, the effect was confined to the surface of the resin. Recently attempts have been made to improve the efficiency of this process by providing exchangers with a more open structure. Three types have been described, one in which an inorganic material with a porous structure such as kieselguhr is coated with a sulphonated polystyrene, another in which the resin itself is expanded and made porous and a third which uses chemically modified cellulose which is permeable to the large molecules. (*Chemical Products*, April 1958.)

## DARWINISM THROUGH HUNDRED YEARS

P. K. MENON \*

Dept. of Zoology, Presidency College, Madras-5

IT was an uncommon coincidence in the history of science that two tireless naturalists, Darwin and Wallace, should have been writing up their views on the problem of the origin of varieties and species in nature at the same time in different places unknown to each other, and should have come to nearly identical conclusions. Wallace was then in the Malay Archipelago. His essay "on the Tendency of Varieties to Depart Indefinitely from the Original Type", was sent to Darwin for perusal and subsequent communication to Lyell for publication if found fit. Darwin, on the other hand, at the persistent insistence of Lyell and Hooker was writing up his theory of Natural Selection which he had conceived clearly even in 1839, on the basis of his laborious collections and studies particularly during his 5-year voyage in the Beagle. This was early in the summer of 1858. The receipt of Wallace's essay created a crisis in Darwin's life. But true to his character and generosity his first reaction was to hold back his own work and allow Wallace's to be published. Lyell and Hooker had to use all their powers of persuasion to make Darwin consent to have an abstract of his own manuscript published along with Wallace's essay in *The Journal of the Proceedings of the Linnean Society*. This was the epoch-making Darwin-Wallace essays of 1858, of which the centenary is now being celebrated. Lyell and Hooker did not stop at that. They pressed Darwin to prepare a volume on his theory. At the end of more than a year of hard work, the volume was published in 1859 under the title, "On the Origin of Species by Means of Natural Selection, or the Preservation of Favoured Races in the Struggle for Life". (The "Origin of Species" or "The Origin", for short.)

It is implied in the title itself that Natural Selection is not Evolution. The two are different facts of nature. According to Darwin, and it is generally accepted, the former is the means by which the latter is brought about. This causational relation between the two is the essence of the theory of Darwin, what has come to be known as Darwinism. Though the credit for putting the concept of evolution on a scientific basis of facts of nature is mainly Darwin's, the concept is much older than Darwin. Even the Greeks had realized that change was the essence of existence,

Darwin's achievement was not the collection of the enormous data to support his theory. Anybody with patience and industry could have done that. Nor was the principle of Natural Selection altogether his own. His inspiration for it was from Malthus's Essay on Population. His real achievement was, as Carter says (1957), that from such simple and common premises he "produced the fundamental and, to his contemporaries, novel results of his proof of the truth of evolution and his theory of its causation". To those who accepted it, it provided a unifying concept in the light of which organisms ceased to be isolated entities, and came to be understood as part of the single flux of life continually changing with the changing world. Darwin gave Biology an intelligible background and made it logically comprehensible.

The early reaction to Darwinism was from two sources, from the general public and the biologists. There was fierce sentimental opposition from a section of the public to evolution and its method as expounded in Darwinism. So, it is no wonder that the simple forthright interpretation of evolution by Darwin in terms of fortuitous events leading to order and seeming purpose through Natural Selection was unpalatable to them as it conflicted with their ideas of the Creator and Design. The climax of this was reached at the Oxford Meeting in 1860 at which Bishop Wilberforce deliberately attempted to "smash Darwin" and ended up in being smashed by Huxley.

The more important point was the reaction of the biologists to Darwin. Generally, the biologists of the day reacted favourably, but it should not be imagined that all the biologists acknowledged the theory without adverse criticism. There were many points of criticism which were valid and real weaknesses of Darwinism. The following few among many are noteworthy.

1. Though Darwin had observed variations and realized their basic importance to evolution, he was fully ignorant of their causes or nature. He himself admitted and deplored it and considered the so-called acquired variations also as important to evolution. He even went to the extent of suggesting a mechanism of inheritance in the form of his theory of *pangenesis* which however never deserved and



got any acceptance. It was exactly this gap in Darwinism that was filled by modern genetics.

2. Evolutionary change involves co-ordinated changes. For example, an increase in the size of the body will need many correlated changes if the animal is to be efficient. Darwin almost overlooked this fact in his thesis. Perhaps he did not consider it as a serious difficulty to his view of evolution by accumulation of small variations. However, such correlated changes are not now difficult to understand in terms of polygenes and pleiotropism (Dobzhansky, 1951), and allometric changes (Huxley, 1932).

3. Those whose biology was based on *Naturphilosophie* did not easily accept Darwinism, as it was not an answer to their quest for the Absolute idea or the Divine plan of Nature or the conception of the archetype. To them law was something immutable, to Darwin it was a deduction from known facts.

4. Many other criticisms, which then looked like real difficulties have lost their point in the light of the new knowledge. One such related to complex structures like the vertebrate eye. The question was, could they have been of any use in the initial stages when they could have hardly functioned? If not, how could they have been selected? A study of the light-perceiving organs in the animal world makes it readily clear that even the simplest of them like the eye-spots of the green flagellates have been functionally efficient at their level. So evolution has not only been in structure but also in function. This removes the seemingly insuperable difficulty to accept the complex organs as the products of Natural Selection.

During the forty-one years of the 19th century after the publication of the "Origin", evolution came to be almost fully accepted, thanks partly to the championship of Thomas Huxley in England and of Haeckel in Germany. Huxley was a competent biologist himself and had no difficulty in winning the battle for Darwin. Haeckel too had accepted Darwinism, but his version of the theory was tinged with *Naturphilosophie*. His chief contribution was the theory of Recapitulation which was almost *Naturphilosophie* with the commonness of descent instead of the archetype. It was quite contrary to Von Baer's laws of ontogenesis. In the later years of the 19th century, Darwinism remained practically unchanged except for the rejection of the Lamarckian part of it along with Lamarckism in general, as a consequence

of the Weismannian theory of the isolatedness of the gonad from the soma, so as to leave the former unaffected by the changes of the latter. In this period there was little progress in evolutionary biology, but there was an enormous output of morphological work in the several branches of biology. Much of it was by way of attempting to prove evolution and Natural Selection. It was only towards the end of the century that experimental embryology began to change the outlook of biologists a little.

The present century began with evolution well established as a fact, except for those who did not want to accept it. The almost total acceptance of evolution restricted the field of discussion and controversy to the means by which evolution took place. By the close of the 19th century, Darwinism too had been accepted as the means of evolutionary change. The idea had penetrated all aspects of human thought.

The history of Darwinism from the beginning of this century\* is a good example of how a comprehensive scientific concept undergoes change and refinement by impact of growing and more precise knowledge. The most important factor that affected Darwinism in the last 58 years was the rapid growth of the science of heredity, i.e., genetics. "This supplied the missing parts of the structure first erected by Darwin" (Fisher, 1930). The basis of modern genetics was the laws of Mendel published in the latter half of the 19th century. They were far ahead of the times and remained unknown till they were rediscovered in the beginning of this century. The particulate nature of inheritance discovered by Mendel had revolutionary effects on the understanding of evolutionary problems.

Darwin had imagined the hereditary characters of the parents to blend in the progeny like water and milk. That would result in a levelling off of variations to uniformity in the members of a population, and would defeat selection. This was the most serious difficulty in Darwinism and it was obviated by Mendelian particulate inheritance. As shown by Fisher (1930), if inheritance had not been particulate evolution as we know it would not have been possible. Mendelian heredity provided a mechanism for both inheritance and variation, the conservative and the progressive aspects of evolution.

At this stage it may look strange that the first result of the Mendelian studies was to create a degree of disbelief in Natural Selection. De Vries's work on the evening primrose

was published in 1901. He had noticed that many new forms suddenly appeared among his plants and bred true. He called such changes "mutations" and contended that evolution took place at least partly through such abrupt changes without involving the Natural Selection of small variations. Natural selection acted in such cases only after the origin of the new form, conserving or eliminating it. Bateson also held similar views. This gave a new importance to the distinction between the continuous and the discontinuous variations in regard to the process of evolutionary change. Darwin had attached little importance to the discontinuous variations. That accounts for the temporary loss of faith in Natural Selection. Mendelism seemed to conform to the views of these doubters of Natural Selection because of the apparent possibility of the large changes of De Vries and Bateson being inherited as Mendelian units. It was soon found, however, that many kinds of characters of organisms were inherited in the Mendelian manner. Meanwhile Morgan and others discovered the cytological basis of Mendelian inheritance in terms of chromosomes and genes, and their behaviour in reproduction. It will be going too far from the topic to consider the progress of genetics in the last fifty years. Suffice it to say that in this period, genetics became in itself an exact body of science and illumined many dark corners in biological knowledge, particularly in evolutionary studies. The understanding of genetic variations, mutations in the wide sense, their nature and frequency and even some of their causes (Muller, 1927), the problems of population genetics, the conceptions of the genotype and the phenotype, clarified and strengthened Natural Selection steadily and surely. But as mentioned earlier, the first impact of genetical knowledge on Darwinism had the unexpected result of many giving up the theory. It is not difficult to understand either. Darwinism involved the gradual accumulation by Natural Selection of small-graded changes. This was the indication of palaeontological studies too. On the other hand, the early genetics dealt with changes that could be readily and easily noticed and so were of the discontinuous type. It seemed impossible to the leading biologists of the day that the observed evolutionary changes could be the result of selection of such genetic changes. This led to violent clashes in the biological world in the first two decades of this century. Bateson took an extreme view and declared that the Darwinian theory had collaps-

ed. He went to the extent of reverting to a sort of preformationism in evolution, involving the progressive expression in organisms of the potentialities that had existed from the beginning of evolution. Many took up similar though less extreme views.

The real point at that time was whether the small variations on which Natural Selection was said to act were also Mendelian. This was not discussed then, as probably it could not have been in that state of genetical knowledge. The discussion was concentrated on whether the continuous or the discontinuous variations were the raw materials of evolution. This was a wrong question to ask and largely accounts for the biological stalemate of the time. This was resolved by further genetical studies in the recent decades. Two important advances in the field of genetics contributed to this. One was the new outlook on the genotype, and the other the new approach to studies of natural populations and their genetics. These also threw revealing light on the operations of Natural Selection.

In the earlier decades of the century a genotype was considered more or less as an aggregate of genes, each with a degree of independence of action. Recent decades brought the realization that the genes of a genotype constitute an intricately interacting system and that the phenotype is the product of such combined action of the genotype and the environment. A mutation in such a system will have its effect much modified by the other genes present and also by other mutations. Since individuals in a population vary in their genotype the effect of a mutation also will vary correspondingly. Further, when many genes may influence a character and any one gene may influence many characters the phenotypic expressions of the individuals may show the gradation observed in the palaeontological studies of evolutionary changes, and envisaged by the theory of Natural Selection. It is true that a mutation is inherited as a unit, all or none. But its expression in the individual depends on the genotype and the environment. That explains the varying effect of mutation on individuals. However, it should not be forgotten that there are many known instances of mutations with phenotypic effects very distinctive and inherited like the characters of Mendel's peas. The pigmentation in what is known as "industrial melanism" is one such. They are comparatively rare. Normally in nature the differences are those based on many genes and varying in degree. This understanding

brought about a reconciliation between the geneticists and the selectionists and the objection of Bateson and others thus disappeared. It also became clear that selection was not directly of the genotype but through the phenotype. Selection of a particular phenotype meant the selection of the genotype that produced it. It is largely a case of selection of the favourable recombinations of genes and allows for a margin of phenotypic adjustment to environmental variations. In the course of generations the more suitable gene combinations become more numerous in the population. In this process the favourable mutations that may arise may be incorporated into the genotype. The first effect of any mutation is usually a discordance as it is something new in a harmonious system. But subsequent selection will integrate it into the genotype if useful, or eliminate it if harmful. Either way, the harmony is restored which implies that a mutation has to undergo a probation before it is accepted as a full member of the genotype with suitable modification of its action by the rest of the genotype (Huxley, 1942). Natural Selection in this sense is the differential survival of the favourable genetic variants.

The slowness of selection makes observation of changes very difficult, if not impossible, but something like it has been observed in recent times. Germs are known to develop resistance to antibiotics rather quickly and this is obviously a case of selection of the favourable genotype at the expense of the others, in the presence of a new factor in the growth medium, the antibiotics (Demerec, 1950). Varieties of *Drosophila* kept in equal numbers in set environments have been found to undergo selective survival in relation to the environment. Green *Mantis* was found to survive largely when tied on green grass but mostly eaten by birds on brown grass. On the other hand, brown *Mantis* survived on brown grass but got decimated on green grass. The selective advantage of harmonising colour is thus demonstrated. These may not be true pictures of selection in nature. But their value is significant.

The new knowledge of selection in genetical terms has in its turn clarified the nature of the changes within a species and between species. That brings us to population studies, another sphere of advance in recent times. The world of biology owes tremendously in this connection to the brilliant mathematical analyses of the genetics of population and selection by R. A. Fisher (1930), J. B. S. Haldane (1932) and Sewall Wright (1942). To this must be

added the names of Dobzhansky, E. B. Ford and E. Mayr. Their expositions of the interactions of selection, mutation and the other factors of evolution in populations have made possible the synthesis of varied observations and experimental results into a coherent thesis (Simpson, 1942).

The subtle ways of the operation of Natural Selection, and evolution by selection are now satisfactorily understood. The obvious fact that some individuals in a population leave more progeny than the others makes Natural Selection inevitable. This ability to leave more progeny than others in a particular environmental setting is the real fitness in the Darwinian sense. The well-known expressions "struggle for existence" and "the survival of the fittest" were used by Darwin in a metaphorical sense "I should premise," said Darwin in the 'Origin', "that I use this term in a large and metaphorical sense including... success in leaving progeny." The convenient literal interpretation of the expressions by some persons is quite unwarranted. Reproductive success based on advantageous genotype is therefore the essence of evolutionary change. A population will gradually change in the direction of the genotype which continues to leave more progeny in successive generations. This is how Natural Selection directs evolution using the 'random' genetical variations as the raw material. This is the most significant contribution of the present century to the understanding of Darwinism.

This article is an attempt to trace the history of the theory of evolution by Natural Selection, during the hundred years since Darwin and Wallace propounded it. In the period the theory has been knocked into a cocked hat. But the core of it has stood the test of time. Generally it is adequate to explain the process of evolution, but there are still many problems of evolution, particularly in regard to the large evolutionary changes, which it is not adequate to explain. Most of the biologists agree with Darwin that varieties are incipient species and that species differ from varieties only in the greater degree of divergence making their natural interbreeding difficult or impossible. Some authorities like Goldschmidt (1940) do not agree with this view. He postulates radical mutations which he calls 'systemic mutations' to produce species differences. How such radical changes in individuals with integrated genotype can leave them viable is difficult to see.

There are others who are not convinced of the effectiveness of selection in regard to all the known evolutionary changes. Many bring in the Lamarckian factor in some sort of way. One of the latest is C. H. Waddington (1957). In terms of "genetic assimilation", "epigenetic landscape" and "canalized development" he suggests a causal relationship between an effect caused by the environment and the production and the selection of appropriate mutations. A phenotypic alteration within the normal range of expression of the genotype is understandable. There is no difficulty to see how such a change may help an organism to tide over a reasonable period during which the genotype may be harmonized to the new conditions by selection of appropriate mutations. The difficulty is to understand how enough of the suitable mutations arise at the right time. One possibility is to suppose that mutations are so common and varied as to supply the needed ones. To Waddington this is probably too much to suppose and so he postulates a developmental mechanism.

Fisher (1930) summed up the position as follows:

"The sole surviving theory is that of Natural Selection, and it is impossible to avoid the conclusion that if any evolutionary problem

appears to be inexplicable on the theory, it must be accepted at present merely as one of the facts which in the present state of knowledge seems inexplicable." Since this was written many more problems have been explained. But many still remain and the words are still true. It is also implied that with the continued progress of knowledge the area of the inexplicable problems will progressively diminish.

- 
1. Carter, G. S., *A Hundred Years of Evolution*, 1957, London.
  2. Demerec, M., *Reaction of Populations of Unicellular Organisms to Extreme Changes in Environment*, 1950, America.
  3. Darwin Charles, *The Origin of Species*, 1859, London.
  4. Dobzhansky, T., *Genetics and the Origin of Species*, 1951, New York.
  5. Fisher, R. A., *The Genetical Theory of Natural Selection*, 1930, Oxford.
  6. Haldane, J. B. S., *The Causes of Evolution*, 1932, London.
  7. Huxley, J. S., *Evolution, the Modern Synthesis*, 1942, London.
  8. Simpson, G. G., *The Meaning of Evolution*, 1949, Yale.
  9. Waddington, C. H., *The Strategy of the Genes*, 1957, London.
  10. Wright, S., *Statistical Theory of Evolution*, 1931, America.

---

### FISCHER-TROPSCH PROCESS

THE traditional form of fixed catalyst bed in the early Fischer-Tropsch process was a very inefficient arrangement, both as regards aerodynamics and heat transfer and this, in part, accounted for the very wide range of synthetic products produced. The fluid bed has been one device adopted to minimise these variations between different parts of the solid bed. The use of a genuine liquid bed for catalysis is a stage further. In this case the catalyst is suspended in a liquid through which the gaseous mixture rises in a constant stream of bubbles. The finely divided catalyst, with an average grain size of approximately  $5\mu$ , collects at the surface of the rising bubbles and is constantly renewed there. The temperature can be kept remarkably constant, variations being not more than about  $1^\circ\text{C}$ . At temperatures of  $250\text{-}300^\circ\text{C}$ . and at pressures of 8-15

atmospheres, the synthesis gas is converted into hydrocarbons to the extent of over 90% in a single passage through the bubble column. The heat of reaction is removed by a cooling coil suspended in the bubble column and is converted into steam. Whereas by the traditional method the conversion of  $1,000\text{ m}^3$  of synthesis gas per hour required a cooling surface of 3,000 square meters, in a bubble column type of catalyser less than 50 square meters surface is required and the capacity of a single reactor has been raised from approximately 2.5 tons of hydrocarbon per day to 50 tons per day. The method has been used not merely for the hydrogenation of carbon monoxide but for the direct creation of carbon monoxide with water, according to the equation  $3\text{CO} + \text{H}_2\text{O} = -\text{CH}_2 + 2\text{CO}_2$ .

# STACKING FAULTS IN CLOSEPACKED METALLIC LATTICES

## Part I. The Nature and Origin of Stacking Faults

T. R. ANANTHARAMAN

Department of Metallurgy, Indian Institute of Science, Bangalore-3

### INTRODUCTION

IN solid metals, the atoms or positive ions are held together by a cloud of free electrons and each atom tends to be attracted equally to all its nearest neighbours. The majority of metals crystallize therefore in highly close-packed structures.

A closepacked atomic lattice can be visualized as a regular pile of closepacked atomic planes. The atoms in each plane lie in three sets of lines (Fig. 1) which are physically

faulty f.c.c. or h.c.p. structure. Any break in the sequences ABCABC— and ABABAB— is normally referred to as a “stacking fault”. The existence of such stacking faults in metallic lattices was first detected in 1942 in the case of h.c.p. cobalt.<sup>1,2</sup> It is now known that stacking faults are introduced fairly commonly in metals by plastic deformation or phase transformation, and also during crystal growth. Such faults may be distributed randomly, clustered together or arranged more regularly in the

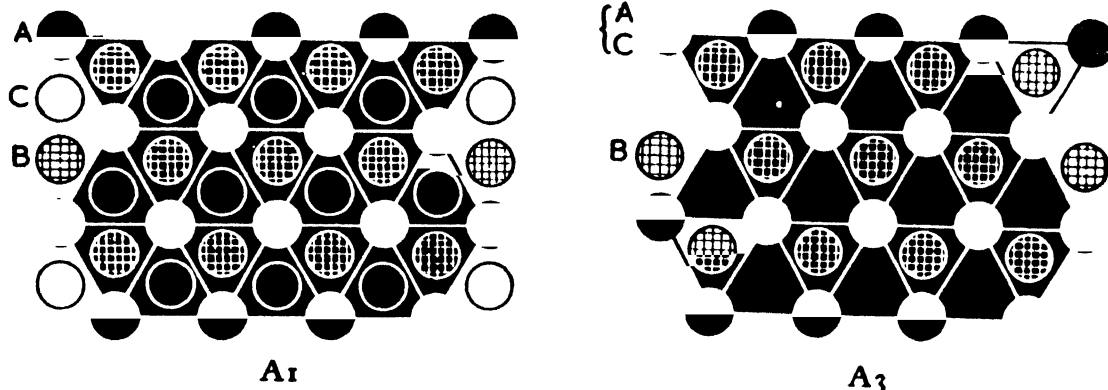

FIG. 1. Formation of closepacked lattices from closepacked atomic planes (B and C are the two possible positions for the plane above A.  $A_1$  and  $A_3$  are the f.c.c. and h.c.p. sequences respectively).

equivalent and  $120^\circ$  to each other. If the letter A represents one such plane, the next plane can be put above it in two possible positions represented by letters B and C. Any arrangement or mode of stacking of planes of types A, B and C gives a closepacked structure, provided no two successive layers are alike. The closepacked metallic lattices normally exhibit either the ABCABC— or the ABABAB— sequence. The former is the so-called face-centred cubic (f.c.c.) structure adopted by common metals like aluminium, copper, gold, nickel and silver. The latter is the hexagonal closepacked (h.c.p.) structure exemplified by metals like cadmium, magnesium, titanium, zirconium and zinc. Cobalt is an interesting metal which exists in both modifications.

The f.c.c. and h.c.p. structures are the only two perfectly regular of the common closepacked structures. Any other sequence of layers, subject only to the condition that any two adjacent layers must be in different positions, is still closepacked, but has to be considered a

lattice. They contribute to the anomalous broadening of X-ray reflections and have recently been recognized as playing an important role in the work hardening of metals.

### LAWS OF GROWTH AND DEFORMATION FAULTING

It is common practice to classify stacking faults in closepacked lattices into “growth faults” and “deformation faults”. The differences between the two types are easily understood on the basis of simple laws for their formation.

The law of growth faulting for the f.c.c. structure is that each atomic plane is displaced relative to the two planes immediately beneath it, except at a fault where it is above the plane next but one below it. For the h.c.p. structure, each plane is above the layer next but one below it, except at a fault. Typical sequences of planes are thus:

ABCABCBACBAC .. f.c.c. growth fault  
 ABABABCBCB .. h.c.p. growth fault

The f.c.c. growth fault produces a twin orientation, an ABCABC— sequence being converted to a CBACBA— sequence. In the h.c.p. structure, however, owing to the different symmetry, the two halves have the same orientation and differ only by a translation. A growth fault introduced at each plane of the h.c.p. lattice produces the f.c.c. lattice and *vice versa*. There is thus a continuous transition between the two structures represented by an increasing number of randomly distributed growth faults.

The law of deformation faulting for both structures is that the lattices on either side of the fault have identical orientation, but the two halves are displaced parallel to the closepacked planes. Typical sequences of planes are thus :

ABCABCBCABCA	..	f.c.c. deformation fault
ABABABCACACA	..	h.c.p. deformation fault

For both structures, therefore, a deformation fault can be considered equivalent to a cluster of two growth faults on neighbouring atomic planes.

A deformation fault introduced at every plane of an f.c.c. lattice gives an f.c.c. lattice of twin orientation. Similarly, one h.c.p. sequence is converted to another h.c.p. sequence by including a fault in each plane. Thus there is no continuity between the two lattices as in the case of growth faulting. A random arrangement of growth faults in either structure produces therefore quite different X-ray diffraction effects from the corresponding structure with a random arrangement of deformation faults.

The laws postulated above implicitly assume that a stacking fault extends over the whole of an atomic plane. In reality, however, a fault may occupy part of a plane and be bounded by what are known as "imperfect dislocations" in the lattice. It is not possible with present experimental methods to establish whether stacking faults occupy part or whole of the atomic plane. The quantity that can be experimentally measured by X-ray methods is  $\alpha$ , the frequency of faults or faulting parameter, which can be defined as the ratio of the total area of faults to the total area of closepacked planes. Such measurements are further based on the assumption that the faults are *randomly* distributed in the lattice.

#### STACKING FAULTS FROM CRYSTAL GROWTH

If a closepacked lattice is built up by the successive growth of closepacked atomic layers in such a way that each layer forms from a fresh two-dimensional nucleus, there will be a finite

probability of a layer going into the wrong position. When the kinetics of growth are such that the rate-limiting factor is the time to form the two-dimensional nucleus, the latter will spread rapidly over the plane after attaining a critical size. If a stacking fault is nucleated, it will occupy most of the plane. This is the situation envisaged in the law of growth faulting. It might arise during electrodeposition, growth from the vapour at high degrees of supersaturation and in certain types of nucleation and growth phase transformations. Fine twinning that can be observed in electrodeposited copper has been attributed to growth faulting.<sup>3</sup> Since these twins are visible microscopically, the faults seem to occur once in a few thousand atomic planes. X-ray diffraction effects become appreciable only at values of  $\alpha$  corresponding to a twin thickness of less than a hundred atomic planes.

It is also possible, especially in transformations requiring long-range diffusion, that the rate of growth of a layer is small compared to its rate of nucleation. Growth faults will then form more readily, but will seldom grow to dimensions of the order of a whole plane. An aluminium-silver alloy with 30% silver prepared by condensation of the vapour has been found to contain both h.c.p. and f.c.c. phases together with a faulted structure at the junction of the two phases.<sup>1</sup> Growth faults have also been reported in vacuum-deposited pure silver,<sup>4</sup> but neither effect has been studied quantitatively.

#### FAULTING DUE TO MARTENSITIC TRANSFORMATION

The formation of growth faults during martensitic transformations (*i.e.*, athermal, solid-state transformations involving simultaneous and co-ordinated movement of atomic planes in the lattice) has been clearly demonstrated in the case of h.c.p. cobalt<sup>1,2</sup> and h.c.p. lithium.<sup>5</sup> Quantitative estimation indicates that the faults are of the order of one in ten atomic planes in cobalt and even more in lithium. The faults in cobalt are of a rather complex nature and the results are often consistent only if the faults are assumed to be not completely random, but clustered together.<sup>6</sup>

The origin of faults during martensitic transformation has not yet been clearly understood. Such transformations are supposed to take place homogeneously with a macroscopic shear<sup>7</sup> and so, faults can arise only when transforming domains from different nuclei meet out of phase or when the transformation proceeds inhomogeneously in the regions between the macroscopically sheared layers already formed. The

magnitude of the faults is far too much, however, to be explained this way. In h.c.p. cobalt, the most extensive faulting is observed in specimens which have been plastically deformed to assist the f.c.c.  $\rightarrow$  h.c.p. transformation. Such specimens then contain both growth and deformation faults,<sup>6</sup> whose combined effects cannot

worked metals or alloys might be due to stacking faults. Evidence for the presence of deformation stacking faults in cold-worked closepacked metals is now available in the case of  $\alpha$ -brass,<sup>7</sup> h.c.p. cobalt,<sup>6</sup> nickel and silver,<sup>9</sup> gold,<sup>10</sup> nickel-cobalt alloys,<sup>11</sup> copper and a number of its binary alloys<sup>12</sup> and a few martensitic steels.<sup>13</sup> The faulting parameter varies in such cases in the range 0.001-0.05. In some instances,<sup>11-13</sup> interesting correlations have been arrived at between the incidence of deformation fault and changes in electrical and mechanical properties.

Deformation faults are supposed to arise by the slipping or gliding of closepacked atomic planes over one another during mechanical deformation. In the case of an ABABAB— h.c.p. sequence, deformation faulting can occur only by both A and B planes gliding to the C positions. These are opposite so far as arrangement is concerned, but only require atom movements at 60° to each other and hence may be produced by the same shear stress.

#### DETECTION AND EVALUATION OF STACKING FAULTS

As pointed out earlier, the detection of stacking faults as well as the quantitative evaluation of the faulting parameter is possible only by X-ray methods. The effects of stacking faults on X-ray diffraction from faulted closepacked lattices have been worked out in detail by several authors and can be best understood in terms of the reciprocal lattices of the two closepacked structures. In Part II of this review, a simple, composite picture of the X-ray diffraction effects of the four types of stacking faults will be given. A clear understanding of these effects is absolutely necessary for both qualitative as well as quantitative determination of the faulting parameter.

In general, the presence of stacking faults is revealed by streaks (Fig. 2) in Laue and Oscil-

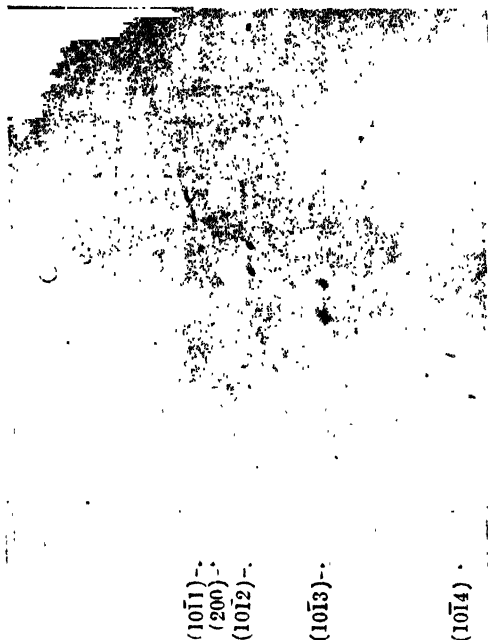

FIG. 2. Streaks due to stacking faults in an oscillation photograph of a grain in a massive cobalt specimen ( $\text{Ni K}_\alpha$  radiation, range of oscillation 15°).

be easily separated for reliable quantitative estimation of either.

#### ORIGIN OF DEFORMATION FAULTS

In 1952, exactly ten years after the first detection of stacking faults in a metallic structure, the suggestion was put forward<sup>3</sup> that a large part of the X-ray line broadening of cold-

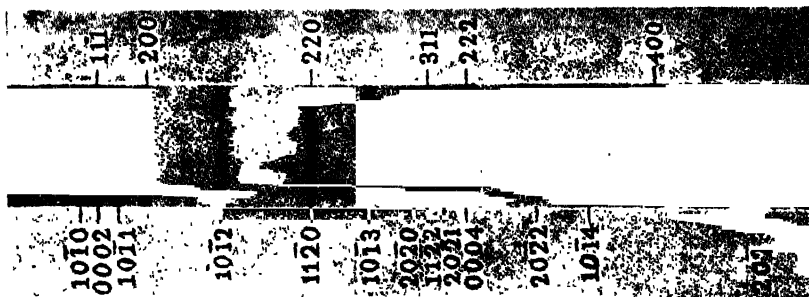

FIG. 3. Anomalous broadening of X-ray reflections in a Debye-Scherrer pattern of pure cobalt ( $\text{Ni K}_\alpha$  radiation 9 cm. camera).

lation photographs and by the anomalous broadening of some lines (Fig. 3) in Debye-Scherrer patterns. These streaks and broad lines are easily detectable when the faulting frequency is greater than one in fifty planes. The establishment of the actual type of faulting as well as the accurate measurement of the faulting parameter is, however, possible only through a detailed study of the nature of the streaks or line-broadening, as dealt with in Part II of this review.

(To be continued)

1. Edwards, O. S. and Lipson, H., *Proc. Roy. Soc.*, 1942, **180A**, 268.
2. Wilson, A. J. C., *Ibid.*, 1942, **180A**, 277.
3. Barrett, C. S., *Imperfections in Nearly Perfect Crystals* (Chapter 3) John Wiley & Sons, Inc., New York, 1952.

4. Gottsche, H., *Zeit. Physik*, 1953, **134**, 504.
5. Barrett, C. S. and Trautz, O. R., *Trans. A.I.M.E.*, 1948, **175**, 728.
6. Anantharaman, T. R. and Christian, J. W., *Acta Cryst.*, 1956, **9**, 479.
7. Basinski, Z. S. and Christian, J. W., *Phil. Mag.*, 1953, **44**, 782.
8. Warren, B. E. and Warekois, E. P., *Acta Met.* 1955, **3**, 473.
9. Anantharaman, T. R., *Doctorate Thesis* (Chapter 9) University of Oxford, 1954.
10. Hirsch, P. B., Kelly, A. and Menter, J. W., *Proc. Phys. Soc.*, 1955, **68B**, 1132.
11. Christian, J. W. and Spreadborough, J., *Phil. Mag.*, 1956, **1** (8th Series), 1069.
12. Smallman, R. E. and Westmacott, K. H., *Ibid.*, 1957, **2** (8th Series), 669.
13. Otte, H. M., *Acta Met.* 1957, **5**, 614.

### ORIGIN OF RADIO BURSTS FROM THE SUN

AUSTRALIA has shared with Cambridge and Manchester in the advancement of the still young science of radio astronomy to a position in which it contributes seriously to many different branches of astronomy. A method of following the course of radio bursts from the sun—that remained for several years “special” to Australia is believed to be within sight now.

The originator of the method was Mr. J. P. Wild of the Radiophysics Laboratory, the Commonwealth Scientific and Industrial Research Organization. Mr. Wild's first apparatus was begun in 1948, and a second and much bigger instrument completed in 1952. By this time there was comparatively little activity on the sun, and often weeks would go by without anything of interest being recorded. However there was enough experience to enable the main kinds of radio burst to be distinguished and tentatively interpreted; during recent months there have been several bursts a day, and observations of a new kind have been made.

The main instrument consists of a trio of directional receivers, each capable of scanning a wide band of frequencies at half-second intervals. The frequencies covered a range from 40 to 240 megacycles a second, corresponding with a wavelength range from 1.25 to 7.5 metres. Records of intensity against time are displayed on a cathode ray tube, and in normal use are recorded photographically. For quick reporting of activity in connexion with the International Geophysical Year, a facsimile system has been introduced, similar to that used in transmitting pictures by radio.

The two most interesting types of radio burst differ greatly in their speed of development.

In both there is a drift from higher frequencies to lower as the burst proceeds. But whereas a “slow-drift burst” may last for 10 minutes or so, a “fast-drift burst” is over with in a few seconds. The theoretical interpretation—plausible but so far unproved—is that the different frequencies observed correspond with natural frequencies of oscillation at different heights in the sun's atmosphere. Hence, it is suggested, an outpouring of particles from the sun's surface stimulates successive layers of its atmosphere to act as a source of radio waves, each at its own frequency, or a harmonic of it. In this way—provided that the explanation is correct—it has been possible to work out what the outward speeds of the particles should be, so as to correspond with the observed drift in frequencies.

In the case of ‘slow-drift burst’ the speeds deduced are usually from about 200 to 400 miles a second, and the disturbances can be followed—again if the explanation is correct—to distances above the sun's surface nearly as great as the radius of the sun. Such speeds correspond well enough with the interval between the bigger optical flares that can be seen on the sun and the beginning of auroral displays and magnetic storms that particle-streams, arriving from the sun, are thought with good evidence to cause on the earth. Also the “slow-drift bursts” are usually accompanied by big visual flares.

“Fast-drift bursts” are much more common. Sometimes one at a time, sometimes in small groups, they occur at the start of many flares, including small ones. Yet the speeds deduced are much higher—about one-third of the speed of light.



## LETTERS TO THE EDITOR

## THE FLUORESCENCE SPECTRA OF URANYL ACETATE SOLUTIONS

THE fluorescence spectrum of aqueous solution of uranyl acetate is reported to be continuous at room temperature, resolving at  $-185^{\circ}\text{C}$ . into a sequence of broad bands. With dilution in the ratio 1:160 a second series of bands appeared and at dilution 1:1600 both band sets vanished, giving room to a third sequence of very diffuse bands.<sup>1,2</sup> Our observations show that at room temperature the spectrum actually has some structure (Fig. 1 a) which improves on dilution (Fig. 1 a'). Addition of acetic acid reduces the intensity considerably (Fig. 1 b), while alkali increases the intensity (Fig. 1 c), although with further addition the spectrum becomes continuous and the intensity falls rapidly (Fig. 1 d). On standing overnight this solution regains in intensity, and the fluorescence spectrum is also different (Fig. 1 d').

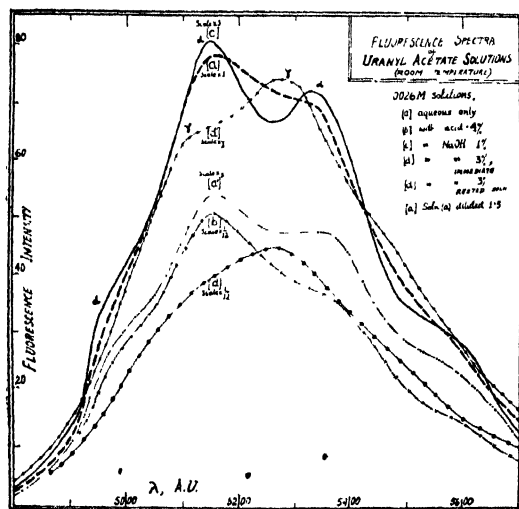

FIG. 1

To observe the variety of changes that take place in the spectra at liquid air temperature, titration with alkali or acid had to be followed in a large number of small steps. Only a few characteristic spectra are shown in Fig. (2 a to f). It will be seen that the bands marked  $\alpha$  (Fig. 2 a) correspond to the diffuse

maxima at room temperature and fall at 4930, 5145, 5385 and 5625 Å. The bands marked  $\gamma$

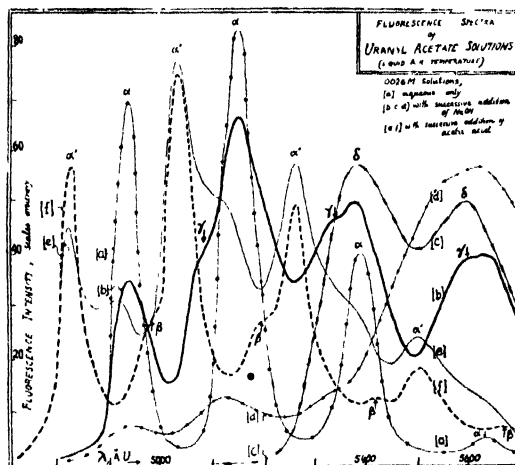

FIG. 2

(Fig. 2 b) form the second series and increase in intensity with increasing alkalinity. A sharp change then takes place when the third sequence bands, marked  $\delta$ , replaces the first two (Fig. 2 c). With further addition of alkali these bands go on shifting continuously towards red (earlier stages not shown), and ultimately another change takes place, giving the spectrum (2 d). On the other hand with successive addition of acid to a solution that gives spectrum 2 b first the  $\gamma$  bands disappear (Fig. 2 a), and then the  $\alpha$  bands are suppressed, giving place to a new set of distinct bands (marked  $\alpha'$ ) located at 4825, 5030, 5260 and 5505 Å. (Fig. 2 e. f). In addition, a weak set of bands, marked  $\beta$ , also develops.

We express our thanks to the Scientific Research Committee, U.P., for financial assistance.

Dept. of Physics, D. D. PANT.  
D.S.B. Govt. College, D. P. KHANDELWAL.  
Naini Tal, December 5, 1957.

1. Nichols, E. I. and Merrit, E., *Phys. Rev.*, 1914, **3**, 457.
2. Pringsheim, P., *Fluorescence and Phosphorescence*, Interscience, 1949.

**THE PREPARATION OF URANIUM (IV) OXY-FORMATE**

The uranyl ion undergoes photoreduction when a solution of its formate is exposed to sunlight, uranium being precipitated as hydrated oxide. Advantage has been taken of the photolysis for the separation of uranium from sodium, calcium, lanthanum and cerium<sup>1</sup> in this laboratory. When a mixture containing equal volumes of saturated solution of uranium formate in water, formic acid and absolute alcohol is exposed to sunlight bright green crystals are formed. These bright green crystals were filtered, washed several times with absolute alcohol and dried in vacuum at the room temperature for 24 hours. The molecular weight was determined from the  $U_3O_8$  obtained by heating weighed quantity of the compound in platinum crucible. Uranium content was determined by Jones reductor

method.<sup>2</sup> The method adopted for estimation of formate content was to dissolve a weighed quantity in 6N.  $H_2SO_4$  and bringing about hydrolysis by adding NaOH solution in slight excess. After heating to boiling, the precipitate was filtered off and the filtrate was acidified with  $H_2SO_4$ . The estimation was carried out according to standard method<sup>3</sup> by making the filtrate again alkaline with solid  $Na_2CO_3$ . The data recorded in Tables I and II show that the bright green crystals are aquo-oxyformate having the formula  $UO(HCO_2)_2 \cdot 1.5 H_2O$ . Since the compound is a new one, it was considered necessary to estimate the uranium content in the uranium (IV) state by the method adopted by Hatt<sup>1</sup> involving the precipitation of uranium (IV) as phosphate in hydrogen atmosphere followed by titration of the solution of the phosphate in  $H_2SO_4$  against standard  $KMnO_4$ .

TABLE I  
Mol. wt. (Theoretical) : 371.0  
Mol. Formula :  $UO(HCO_2)_2 \cdot 1.5 H_2O$

Compound taken in g.	$U_3O_8$ found in g.	Mol. wt. computed	Compound taken	Estimation of $U^{IV}$ by Hatt's Methods	
				Calculated	Found
0.2940	0.2215	372.3	0.1630	0.1032	0.1011
0.0962	0.0725	372.3	0.2805	0.1775	0.1728
0.1155	0.0871	372.0	0.2117	0.1354	0.1314
0.1550	0.1170	371.6	0.2256	0.1443	0.1420

TABLE II  
Separate estimations of uranium and formate contents

Compound taken	U by J. reductor		Compound taken	Formate by alkaline $KMnO_4$	
	Calculated	Found		Calculated	Found
0.1791	0.1149	0.1141	0.1410	0.0342	0.0344
0.1516	0.0972	0.0973	0.1310	0.0318	0.0321
0.1783	0.1144	0.1141	0.1158	0.0281	0.0282
0.1658	0.1036	0.1039	0.1512	0.0367	0.0369

TABLE III

Compound taken	$U_3O_8$		Compound taken	$U^{IV}$ by Hatt's Method	
	Calculated	Found		Calculated	Found
0.1495	0.1219	0.1209	0.2705	0.1871	0.1830
0.1368	0.1115	0.1106	0.2520	0.1743	0.1715

TABLE IV

Compound taken	U by J. reductor		Compound taken	Formate by $KMnO_4$	
	Calculated	Found		Calculated	Found
0.2361	0.1633	0.1629	0.2228	0.0583	0.0568
0.2629	0.1819	0.1813	0.2042	0.0534	0.0529

When the aquo-oxyformate was powdered and heated in vacuum at 160-70° C. for 4-8 hours, the anhydrous compound was obtained. The analysis was carried out as described above and the data obtained have been recorded in Tables III and IV.

The compound is insoluble in water and it undergoes slow hydrolysis which increases with the rise of temperature. The compound does not dissolve in solution of sodium formate. It is, however, soluble in acids. The thermal decomposition is proceeding.

Dept. of Chemistry,  
Ravenshaw College,  
Cuttack-3, March 5, 1958.

B. SAHOO.  
D. PATNAIK.

1. Patnaik, D. and co workers (to be published).
2. Vogel, A. I., *A Text-Book of Quantitative Inorganic Analysis*, 1951, 2nd Edn., p. 318.
3. —, *Ibid.*, p. 289.
4. Hatt, E. C., *Zeit. Physik. Chem.*, 1918, **92**, 513.

#### UTILIZATION OF THE SOLUBILITY DATA FOR THE CALCULATION OF THE COMPOSITION, STABILITY AND FREE ENERGY OF FORMATION OF THE COMPLEX FORMED IN THE SYSTEM : $\text{AgCNS}-\text{NH}_3-\text{H}_2\text{O}$

The direct method of calculation of the composition of complexes from solubility data as suggested by one of us,<sup>1</sup> has successfully been utilized by him to the systems: (i)  $\text{KI}-\text{I}_2-\text{H}_2\text{O}$ , (ii)  $\text{KBr}-\text{Br}_2-\text{H}_2\text{O}$ ,<sup>2</sup> (iii)  $\text{HCl}-\text{Cl}_2-\text{H}_2\text{O}$ ,<sup>3</sup> (iv)  $\text{AgCl}-\text{Na}_2\text{S}_2\text{O}_3-\text{H}_2\text{O}$ ,<sup>4</sup> (v)  $\text{AgBr}-\text{Na}_2\text{S}_2\text{O}_3-\text{H}_2\text{O}$ .<sup>5</sup> These calculations were extended by us to evaluate the formation constant and thermodynamic constants of several other complex forming systems as well.<sup>6, 9</sup>

To test the validity of the calculations to other systems also, we have here studied the data of Garrick and Wilson<sup>10</sup> on the solubility of silver thiocyanate in aqueous ammonia, and have utilised their values for the calculation of composition, stability and free energy of formation of the complex species formed in solution.

The dissolution of silver thiocyanate in aqueous ammonia may be represented by the reaction:

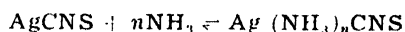

If the solubility of  $\text{AgCNS}$  in water and aqueous ammonia of concentration  $c$ ,  $b$  respectively  $a$  and  $b$ ,

$$\begin{aligned} [\text{Complex}] &= (b-a) \\ [\text{AgBr}] &= a \\ [\text{NH}_3] \text{ used} &= n(b-a) \\ [\text{NH}_3] \text{ free} &= c-n(b-a). \end{aligned}$$

Formation constant

$$K = \frac{[\text{Complex}]}{[\text{AgBr}][\text{NH}_3]^n}$$

Taking two concentrations,  $a$ ,  $a'$ ,  $b$ ,  $b'$ , and  $c$ ,  $c'$  ( $a = a'$ ),

$$K = \frac{(b-a)(b'-a')}{a(c-an+bn)^n a'(c'-a'n+b'n)^n}$$

Putting  $s = (b-a)$  and  $s' = (b'-a')$ , we have,

$$\frac{s}{a(c-sn)^n} = \frac{s'}{a'(c'-s'n)^n}$$

or

$$\frac{s}{s'} = \left[ \frac{(c-sn)}{(c'-s'n)} \right]^n$$

Taking logarithms of both sides we have,

$$\log s/s' = n \{ \log (c-sn) - \log (c'-s'n) \}.$$

Expanding the right-hand side in power series and neglecting the second and higher terms of the series, we finally have,

$$\log s/s' = n \log c/c'.$$

Therefore

$$n = \frac{\log s/s' \cdot \log (b-a)/(b'-a')}{\log c/c' \cdot \log c'/c'}$$

Since  $a$  is small in comparison to  $b$ , the expression becomes,

$$n = \frac{\log b/b'}{\log c/c'}$$

From this expression, we have calculated the value of  $n$ , and as will be seen below, the value comes out to be unity. Hence for the calculation of  $K$ , the following expression has been used.

$$K = \frac{b}{a(c-b)}$$

The free energy of formation  $\Delta F^\circ$  can be evaluated from the relation:  $\Delta F^\circ = -RT \ln K$ , where  $R =$  gas constant, and  $T$  the absolute temperature.

Table I shows the values calculated by us from the data of Garrick and Wilson.<sup>10</sup>

TABLE I  
Solubility of silver thiocyanate in aqueous ammonia

Concentration of ammonia gm./litre	Silver thiocyanate dissolved gm./litre	$n$	$\log K$
1.026	0.00517	..	4.73
1.587	0.00854	1.1	4.74
1.840	0.01001	1.0	4.76
2.178	0.01234	1.0	4.76
2.276	0.01292	0.98	4.75
2.440	0.01376	0.97	4.65

Average  $\log K = 4.72$

The results indicate the formation of  $\text{Ag}(\text{NH}_3)\text{CNS}$ , in a solution of silver thiocyanate in aqueous ammonia. The value of  $\log K$  is 4.72, and that of  $\Delta F^\circ$  works out to be  $-6.5 \text{ K. cal.}$ , at  $25^\circ \text{C.}$

The method described here is only applicable to associated complexes, i.e., where  $sn$  is smaller than  $c$  in order to permit the higher terms of the series to be neglected.

Chemical Labs., ROSHAN LAL SETH.  
University of Allahabad, ARUN K. DEY.  
Allahabad, March 14, 1958.

1. Dey, A. K., *Doklady Acad. Sci., U.S.S.R.*, 1947, **58**, 1047.
2. —, *J. Indian Chem. Soc.*, 1947, **24**, 207.
3. —, *Proc. Nat. Acad. Sci.*, India, 1956, **25A**, 202.
4. —, *Ibid.*, 1956, **25A**, 205.
5. —, *J. Inorg. Nucl. Chem.*, 1958, **6**, 71.
6. Seth, R. L. and Dey, A. K., *Z. Phys. Chem.*, 1958 (in press).
7. —, *Proc. Nat. Acad. Sci.*, India, 1957, **26A**, 312.
8. —, *Naturwiss.*, 1958 (in press).
9. — (Unpublished work).
10. Garrick, F. J. and Wilson, C. I., *J. Chem. Soc.*, London, 1932, 835.

### INITIATION OF POLYMERISATION OF METHYL METHACRYLATE IN AQUEOUS SOLUTION BY HYDRAZINE HYDRATE

N. URR<sup>1</sup> has stated that hydrazine in alkaline solution initiates the polymerisation of vinyl compounds.

It has been observed that hydrazine hydrate in aqueous solution initiates the polymerisation of methyl methacrylate at room temperature and even at  $0^\circ \text{C.}$  The reaction is characterised by a well-defined induction period, the length of which depends upon the concentrations of monomer and hydrazine, the pH of the medium and the type of distilled-water employed. Use of distilled-water of various types, like ordinary distilled-water, doubly distilled, and chemically pure water distilled over potassium permanganate resulted in the variation of the magnitude of the induction period under identical conditions of concentrations of monomer and initiator. The interaction of microconcentrations of organic impurities in distilled-water with free radicals in polymer reactions in aqueous solution has already been demonstrated<sup>2</sup> and our system perhaps provides another instance of such a phenomenon. In Table I are presented the data showing the variation of induction period and the degree of polymerisation of polymethyl methacrylate which was determined by viscosity measurements in benzene.

TABLE I  
Temperature  $25^\circ \text{C.}$  ( $\text{N}_2\text{H}_4$ )  $0.2 \text{ M}$   
(Monomer)  $0.1 \text{ M}$

pH	Induction period (in minutes)	Degree of Polymerisation
10	18	2820
9	22	2440
8	28	1980
7	35	1520

Even under conditions in which the oxygen from the reaction system was excluded by de-aeration by oxygen-free nitrogen, initiation of polymerisation was observed. We have also investigated the reaction in the presence of varying amounts of hydroquinone. Not only was the induction period prolonged but the yield of polymer decreased with increasing

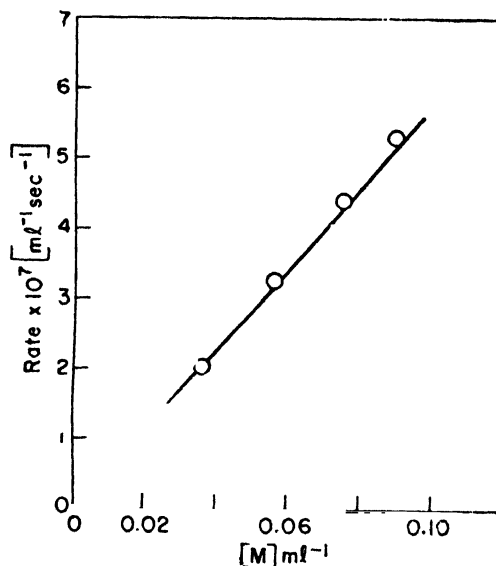

FIG. 1

concentration of hydroquinone, suggesting that the propagation process is a free radical reaction. However, Walling and Briggs<sup>3</sup> have concluded that hydroquinone does not retard the polymerisation of methyl methacrylate in the absence of peroxides and in our polymerisation system the possibility of formation of peroxide by the interaction of hydrazine with traces of oxygen in the system evidently exists.<sup>4</sup>

The rate of hydrazine disappearance which was followed by determining the hydrazine content of the system by Andrew's procedure was found to be independent of monomer

concentration for small conversions. At later stages of the reaction when the polymer formed is appreciable, the polymerisation is accompanied by gas evolution, leading to marked decrease in hydrazine concentration. The rate of monomer disappearance which was followed by finding the weight of the dried polymer, with 0.2 molar hydrazine concentration and at pH 10 was first order with respect to monomer concentration at 25° C. (Fig. 1). Both  $-\frac{d(N_2H_4)}{dt}$  as well as  $-\frac{d(M)}{dt}$  were of the order of  $10^{-7}$  moles/litre/sec. It was also found that the reaction is not sensitized by radiation in the visible range.

In our preliminary experiments we could not identify the probable products of decomposition and oxidation of hydrazine like ammonia and hydrazoic acid. Ammonia can be formed in accordance with the following equation.<sup>5</sup>

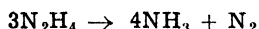

and the formation of hydrazoic acid takes place according to the following scheme.<sup>6</sup>

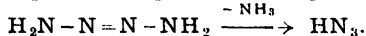
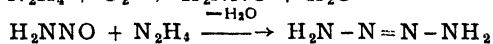
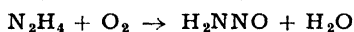

In this connection it is of interest to report that a 0.2 molar solution of hydrazine hydrate undergoes decomposition only to the extent of 3% in 24 hours and that hydrogen peroxide under conditions as in the polymerisation system does not initiate vinyl polymerisations.

Further work is in progress. Full details will be published elsewhere.

Plastics and Polymers  
Division,  
National Chem. Lab.,  
Poona, March 14, 1958.

C. C. MENON.  
S. L. KAPUR.

1. Uri, N., *Chem. Rev.*, 1952, **50**, 375.
2. Santappa, M., *Curr. Sci.*, 1954, **23**, 145.
3. Walling and Briggs, *J. Am. Chem. Soc.*, 1946, **68**, 114.
4. Gilbert, *Ibid.*, 1924, **46**, 1786.
5. Audrieth, L. F. and Ogg, B. A., *The Chemistry of Hydrazine*, John Wiley & Sons, New York.
6. Frankline, E. C., *The Nitrogen System of Compounds* (American Chemical Society, Monograph Series, p. 145).

#### SPECTROPHOTOMETRIC METHOD FOR ESTIMATION OF CALCIUM IN SUGARCANE JUICES USING ETHYLENEDIAMINETETRAACETIC ACID

In a previous communication, the authors<sup>1</sup> described a new spectrophotometric method for estimation of  $Ca^{++}$  in pure salt solutions, using

ethylenediaminetetraacetic acid (EDTA). The principle of the method is that when a mixture of  $Ca^{++}$  and  $Cu^{++}$  in ammoniacal medium is titrated with EDTA, this last combines first with  $Ca^{++}$  and then with  $Cu^{++}$ , resulting in a decrease of the intensity of the colour (at  $\lambda = 630 m\mu$  characteristic of copper ammonium complex) only after the end-point of  $Ca^{++}$  (see Fig. 1). This method is now extended to the estimation of  $Ca^{++}$  in sugarcane juices.

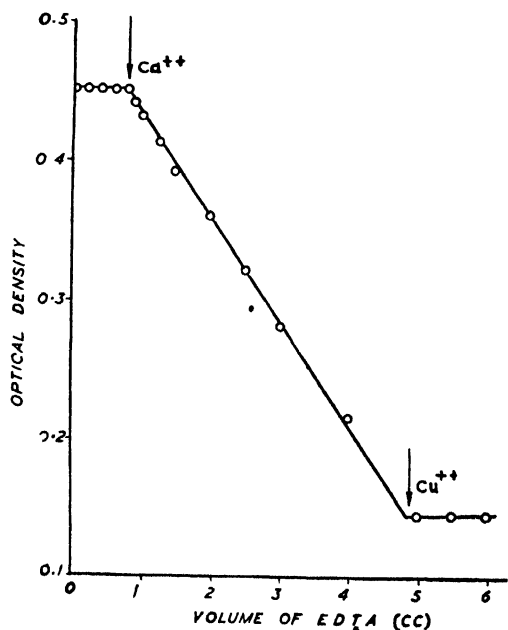

FIG. 1. Spectrophotometric titration of  $Ca^{++}$  with EDTA.

[The arrows indicate the end-points of  $Ca^{++}$  and  $Cu^{++}$  (see ref. 1); the end-point of  $Cu^{++}$  is of no interest for the present work.]

The existence of a certain amount of  $Ca^{++}$  in cane juices controls the clarification efficiency and the scaling problem; and the estimation of  $Ca^{++}$  in cane juice forms therefore one of the routine analyses, in a sugar factory. The method employed hitherto is the familiar oxalate method, which is indeed cumbersome and time-consuming. In the new spectrophotometric method, the cane juice of known specific gravity (or Brix) is treated with lead subacetate (familiar dry lead method adopted for polarisation experiments<sup>2</sup>) and filtered. The excess of lead in the colourless filtrate is precipitated by adding required quantity of solid  $K_4Fe(CN)_6$  and filtered. One or two drops of conc.  $HNO_3$  are added to the lead-free filtrate to convert the ferrocyanide to ferric-condition

such that  $\text{Ca}^{++}$  is not precipitated on long-standing (if required). To an aliquot of this solution is added ammoniacal  $\text{CuSO}_4$  solution and titrated spectrophotometrically with EDTA solution, observing the changes in optical density at  $\lambda = 630 \text{ m}\mu$  on a Unicam Spectrophotometer (D.G. 350; with optical column = 1 cm.).

Table I gives a typical set of data on the estimation of  $\text{Ca}^{++}$  in different samples of clarified cane juice. The results in column 4 refer

TABLE I  
Estimation of calcium in sugarcane juices

Sample No.	BX of the Juice	Amount of CaO in gm per litre of juice	
		Oxalate Method	Spectrophotometric Method
1	17.50	1.0416	1.0413
2	16.76	1.1896	1.1375
3	16.38	1.1123	1.1025
4	15.28	1.1312	1.1200
5	17.67	1.2208	1.2075
6	16.59	0.9770	0.9888
7	18.25	1.1452	1.1288
8	16.91	1.2656	1.2425
9	17.43	1.1718	1.1725
10	15.37	1.1420	1.1375

\* Concentration of  $\text{Cu}^{++}$  used—8 mM.

Do. Ammonia—2mM.

Do. EDTA—50 mM.

to the amount of  $\text{Ca}^{++}$  estimated by the oxalate method. It is seen that the data obtained by the spectrophotometric method agree closely (within  $\pm 0.5\%$ ) with those obtained by the oxalate method. It may be pointed out that while oxalate method requires 8-10 hr. time for completion of analysis, the spectrophotometric method requires 30-40 minutes.

Authors' thanks are due to Professor S. N. Gundu Rao, Director, National Sugar Institute, for his interest in the work; and to the Ministry of Education for a fellowship to one of us (R. K. C.).

Dept. of Physical Chem., N. A. RAMAIAH.  
National Sugar Inst., VISHNU.  
Kanpur, March 24, 1958. R. K. CHATURVEDI.

1. Ramaiah, N. A. and Vishnu, *Anal. Chem. Acta*, 1957, 16, 569.

2. Browne and Zerban, *Sugar Analysis*, 3rd Ed., John Wiley, 1948, 317.

### TRANSFERENCE NUMBER IN BARIUM THIOCYANATE AND LEAD NITRATE BY A MOVING BOUNDARY TECHNIQUE

It is now generally recognised that the conventional Hittorf method of determining transference number of an ion is not capable of the precision attainable with the E.M.F. and moving boundary method. Attempts have been made to modify Hittorf original apparatus<sup>1-3</sup> and to combine Hittorf type cell with moving boundary technique.<sup>4</sup> In testing the inter-ionic attraction theory and its practical applications to conductance, activity coefficient, liquid contact potential, diffusion coefficient, formation of complex ion, the determination of the transference number by the Hittorf analytical method has been largely replaced by the moving boundary system. The technique of observing a following boundary has also been improved.<sup>5</sup>

A convenient apparatus for measuring transference number by a falling boundary is shown diagrammatically in Fig. 1. The cathode

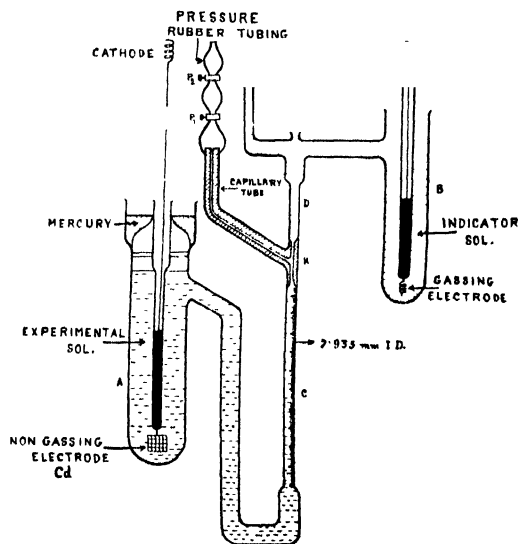

FIG. 1

chamber A and the measuring tube C were washed and filled with the experimental solution. The anode vessel B and the connecting tube D above the joint K were filled with a slower and lighter indicator solution. In this operation a small air bubble was enclosed at the joint K which was withdrawn by opening the pinch-cock  $P_1$  and if necessary  $P_2$  after completing the circuit and no mixing between the indicator and experimental solution thus took place. A constant current may be

maintained by hand regulation or by using a thermionic valve circuit.<sup>6</sup> The falling boundary was timed by means of a stop-watch.

Fig. 2 shows the region where Kohlrausch adjustment between an aqueous sol. of 0.1N

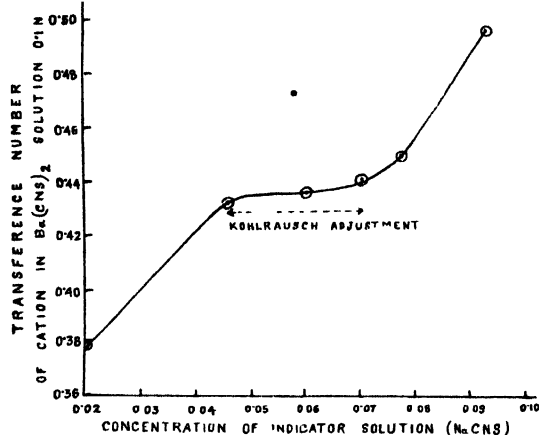

FIG. 2

Ba(CNS)<sub>2</sub> and indicator sol. NaCNS takes place. The cation transference numbers in barium thiocyanate vary markedly (cf. Table I). It could not be ascertained from literature if these values are real. Lack of further information on this electrolyte prevents too much stress being laid on cation complexes.

TABLE I

Concentration Ba (CNS) <sub>2</sub> (C)	$\sqrt{C}$	$T_{Ba^+}$ 25° C.
0.009973 N	0.09986	0.30550
0.01981	0.14075	0.34522
0.03945	0.19862	0.38670
0.06213	0.24925	0.40604
0.08	0.28284	0.42943
0.10	0.31623	0.4564
0.12903	0.35918	0.48181

The only published values of the transference numbers of lead nitrate are due to Falk.<sup>7</sup> These are only at two concentrations. Falk considered his results to be 3.2% lower, than those he probably expected. The agreement between the values obtained in this investigation and those found by Falk is, however, satisfactory (cf. Table II).

It is considered now that Falk's calculation was not correct but that his experimental values are correct. The limiting transference number value  $T^+$  at 25° C. for lead nitrate obtained from the published conductance measurements should be 0.4969 and not the value 0.503 adopted by Falk. According to this, the value of the limiting slope for lead nitrate re-

TABLE II

Concentration Pb(NO <sub>3</sub> ) <sub>2</sub> (C)	$\sqrt{C}$	This investiga- tion $T_{Pb^+}$ 25° C.	Falk $T_{Pb}$ 25° C.
0.01 N	0.10000	0.48839	
0.025	0.15811	0.48823	..
0.02994	..	..	0.4874
0.05	0.22361	0.48766	..
0.10	0.31623	0.48766	..
0.1002	..	..	0.4875
0.15	0.38730	0.48724	..

quired by the inter-ionic attraction theory is -0.13152. This has been drawn in Fig. 3 as

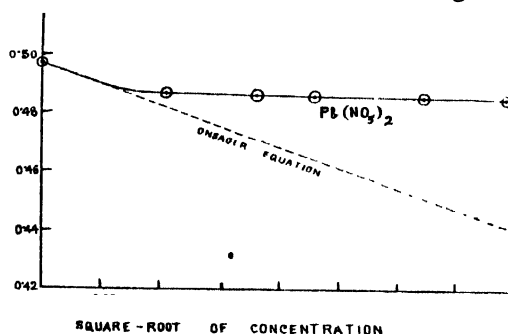

FIG. 3

dashed line. The experimental curve lies entirely above the limiting slope except at the extrapolated end points of the latter. As in this case it has also been observed in rare earth nitrates<sup>8</sup> that the transference numbers do not approach the Onsager limiting slope.

It may be assumed that lead nitrate is incompletely dissociated. On the other hand, the study of Raman effect<sup>9</sup> has shown that lead nitrate is completely dissociated even at high concentration. In general, the presence of complex cations will make the measured cation transference number too large, whereas complex anions will make it too small. If both are present in equal amounts the transference number would obviously remain constant with the change of concentration. This probably occurs with lead nitrate.

Dept. of Chemistry,  
Ranchi College,  
Ranchi, February 26, 1958.

J. N. SAHAY.

- Hallam, H. E., *J. Chem. Edu.*, 1954, **31**, 306.
- Roemer, T. J. and Cooley, R. A., *Ibid.*, 1951, **28**, 37.
- Duke, F. R. and Laity, R., *J. Amer. Chem. Soc.*, 1954, **76**, 4046.
- Brady, A. P., *Ibid.*, 1948, **70**, 911.
- Lorimer, J. W., *et al.*, *Ibid.*, 1957, **79**, 2347, 2350.
- Hartley, G. S. and Donaldson, G. W., *Trans. Faraday Soc.*, 1937, **33**, 457.
- Falk, K. G., *J. Amer. Chem. Soc.*, 1910, **32**, 1555.
- Spedding, F. H. and Jaffe, S., *Ibid.*, 1954, **76**, 886.
- Ram Krishna Rao, *Proc. Roy. Soc.*, 1934, **144A**, 159.

### ON THE TEMPERATURE AND SALINITY STRUCTURES OF THE BAY OF BENGAL

PREVIOUS reports on the vertical temperature structure,<sup>1,2</sup> and the thermal field at various depths,<sup>3</sup> of the Bay of Bengal along the East Coast of India are based on the bathy-thermographic data collected by the personnel of the Andhra University during the period October 1952 to April 1953. The author has more recently reported some semi-permanent thermal features<sup>4</sup> as revealed by the temperature structures constructed by him from the data collected during the period October 1955 to May 1956. A detailed investigation of the time and space variation of the temperature and salinity structures of the Western Bay of Bengal in general and the monthly mean conditions of the waters off Visakhapatnam in particular has been carried out by the author using both the data, the detailed account of which will be reported elsewhere. Some results of this investigation are briefly presented here.

TABLE I

Month	Means		Ranges of	
	Temp. °F.	Sal. ‰	Temp. °F.	Sal. ‰
October ..	84.0	19.85	83.3-86.2	17.06-23.21
November ..	80.7	23.87	81.5-78.5	24.20-23.44
December ..	79.0	28.23	77.5-79.7	26.00-28.49
January ..	78.7	32.84	77.2-79.0	32.74-33.13
February ..	80.0	32.76	79.3-80.9	32.56-33.38
March ..	80.7	33.50	80.0-81.7	34.24-33.08
April ..	82.8	33.87	80.2-85.6	34.34-33.63

Table I shows the monthly mean temperatures and salinities and their ranges for the surface waters over the continental shelf off Visakhapatnam. The sequence of changes in the thermal structure are as follows. The nearly isothermal nature (with slightly positive to slightly negative temperature gradients) of the surface layers upto the depth of the thermocline during October, develops into definite positive gradients of temperature and a subsurface zone of maximum temperature with the 'top-thermocline'<sup>4</sup> below it by November. The temperature gradients at greater depths would remain the same except for a slight change in the depth of the thermocline. These features would persist to some extent even during December. Convective mixing

associated with the winter surface cooling during January and February results in a mixed layer of isothermal nature, eliminating the subsurface zone of maximum temperature, upto about 220' below which the thermocline appears. During March and April the thermocline rises upto the very surface layers due to upwelling which starts by about the end of February along this coast. The seasonal heating in the surface layers results in negative gradients of temperature there and the thermocline gradually transforms into a top-thermocline during this period. At greater depths the isotherms will be closely packed due to intense upwelling taking place from deeper layers bringing up the colder waters. This investigation has further revealed that the month of the maximum intensity of upwelling is variable between April (as in 1953) to March (as in 1956) along this coast, though the period of upwelling generally extends upto May.

The salinity structures revealed that the salinity generally increases with depth in the surface layers during all the months. However, the depth of halocline (the layer in which sharp increase in salinity occurs) would be changing with the season and the close agreement between the depths of the halocline and the top-thermocline suggests that the processes responsible for the formation of both the features might be the same. Isohaline nature is observed over the continental shelf off Visakhapatnam below about 100 m. and 50 m. during the post-monsoon and the hot weather seasons respectively.

In this connection the author expresses his thanks to Dr. R. Ramanatham for his stimulating discussions and interest in the work; to his colleagues of the Geophysics and Zoology Departments for their help in the collection of data and the salinity estimations respectively and to Prof. E. C. La Fond for his guidance in the planning and collection of data.

Geophysics Dept., C. BALARAMA MURTY.  
Andhra University,  
Waltair, March 3, 1958.

1. La Fond, E. C. and Borreswara Rao, C., *Def. Sci. Org.*, 1955, Pub. No. 4/55.
2. Ramasastry, A. A., *Def. Sci. Jour.*, Oct. 1954, 7-16.
3. — and Balarama Murty, C., *Proc. Ind. Acad. Sci.*, 1957, 46 B, 293.
4. Balarama Murty, C., *A. I. O. P. Gen. Assem.*, Toronto, 1957.



### BENEFICIAL EFFECT OF PROLONGATION OF THE WEANING PERIOD ON THE WEIGHTS OF RATS

THE young suckling rat is usually weaned from its mother on the 21st day. It is stated that even after this period it may still continue partially to depend upon its mother if allowed to suckle (Donaldson, 1924). In the absence of any published data it is not possible to indicate whether the prolongation of weaning time would have a beneficial effect on the growth of the young. This communication presents the results obtained in an investigation to elucidate this point.

Eighty healthy female albino rats who were nursing six young ones each were selected. They were made up of equal number of females nursing their first, second, third and fourth litters respectively. On the 21st day the total weight of young in each litter was recorded. These 80 litters were then equally distributed into two groups. Animals in group one were left with the mother for 4 days more while those in group two were separated. The distribution of the 80 litters in the two groups was carried out in such a way that in each group there were 10 litters from each of the four orders of birth with the same number of males and females. This was done so that the better growth capacity of males over females and also the animals from latter litters (Dikshit and Taskar, 1956, 1958) may not mask the beneficial effect of the extension of the weaning period. The average 21st day weights of the young animals in the two groups were the same, *viz.*, about 31.6 for males and 31.0 g. for females. The young animals in both the groups were fed on the stock diet *ad libitum* and they were weighed again on the 25th day. The weight increases in the two groups are represented in Table I.

The analysis of variance of these results is given in Table II.

TABLE II  
Analysis of variance\*

	D.F.	Sum of Sq.	Mean Sq.	F	
Presence of mother ..	1	530.71	530.71	77.7	8.81
Sex ..	1	2.92	2.92		
Mating ..	3	35.80	11.93		
Error ..	154	1052.29	6.83		
Total ..	159	1621.72	..		

\*After correcting for individual differences in initial weights by analysis of covariance the value of *t* for presence (of mother) was found to be 8.87.

(*t* = 8.81; D. F. = 154.)

Although both the groups had almost the same weight on the 21st day and were fed the same stock diet the animals in group one (who were permitted to be with their mothers for 4 days more) had greater weight gains in 4 days than those of group two. The increase in the weight of animals in the first group was fairly uniform, whereas that in the second group was somewhat variable.

The results in Tables I and II indicate that the young animals stand to benefit by the extension of the weaning period. The weight increase in the rats kept with mothers could only be due to extra nutrition that these animals obtained from the mother's milk and cannot possibly be attributed to any psychological effect of the proximity of the mother. This factor may play a very important role in the humans, but it is not known if this also operates in the rats. This observation is thus a pointer in favour of increasing or extending the weaning period. In this connection it may be worthwhile to note that Mendel and

TABLE I  
Average gain in weight of young in 4 days

Order of litter series	Group I—Kept with mother for 4 more days after 21st day					Group II—Separated from mother after 21st day				
	No. of litters	MALES		FEMALES		No. of litters	MALES		FEMALES	
		g.	S.E.	g.	S.E.		g.	S.E.	g.	S.E.
I ..	10	9.04	0.68	8.78	0.83	10	6.18	1.01	5.9?	0.63
II ..	10	9.18	0.99	9.61	0.78	10	5.77	0.80	5.49	0.80
III ..	10	9.29	0.77	8.33	0.51	10	4.24	1.05	4.44	0.97
IV ..	10	8.68	0.68	8.06	0.81	10	4.10	0.92	4.69	1.09

Hubbel (1935) had shown that the supplementation of a protein-rich "paste food" to the usual stock diet caused an increase in the weaning weight of young rats of Connecticut strain from 31 to 48 g. in males and from 30 to 47 g. in females during the period 1925 to 1935. The stock diet fed to our animals contains about 17% protein which as suggested by Goettsch (1948) should be optimal for rat growth. However, the supplementation of breast milk to this stock diet (the composition of which is given by Dikshit and Taskar, 1958) in the experiment for four more days beyond 21 days from birth is definitely conducive to better growth at weaning.

It is as yet not known if and how the higher weight at weaning time influences the subsequent growth rate. A follow-up study of the growth rate of the animals in the two groups was, unfortunately, not undertaken. It was, however, felt that such an information could also be obtained if the growth rates of rats having different weaning weights were studied. With this end in view male rats from 165 litters were selected and distributed into three groups. The weaning weights of animals in the three groups were in the range of 25.0 to 30.0 g.; 30.0 to 35.0 g. and 35.0 to 40.0 g. respectively. As shown in Fig. 1, the growth curve of the

time persisted till the adult stage. Thus the difference in the average weaning weight of animals in groups 1 and 3 was about 9.16 g. while the difference at 120 days was 10.12 g.

Grateful thanks are due to Dr. A. D. Taskar for expert assistance in the statistical analysis. It is a pleasure to thank Mr. S. Rajamanickam for his excellent technical assistance.

Nutrition Res. Labs., P. K. DIKSHIT.  
I.C.M.R., Coonoor,  
February 20, 1958.

1. Donaldson, H. H., "The rat. Data and reference Tables," *Memoirs of the Wistar Institute of Anatomy and Biology*, No. 6, Philadelphia, 1924.
2. Dikshit, P. K. and Taskar, A. D., *Proc. Soc. Exp. Biol. Med.*, 1956, **93**, 235.
3. — and, 1958, To be published.
4. Goettsch, M., *Arch. of Biochem.*, 1948, **19**, 349.
5. Mendel, L. B. and Hubbell, R. B., *J. Nutr.*, 1935, **10**, 557.

#### VARIATION OF COMPRESSONAL VELOCITIES IN INDIAN ROCKS AT LOW PRESSURES

It has been suggested by earlier workers that at low pressures, the dilatational velocity increases with pressures at a considerable rate until it ceases to increase and begins to decrease slightly with pressure. The velocity increase in the low pressure region may be due partly to the finite compression of the specimen and partly to the vanishing of void spaces due to pressure. Compressional wave velocities have been measured and their variation studied in some Indian rocks, by the author, in the pressure region of the order of 4,000 lb./sq. inch. The experimental method used here is similar to that described by Tocher.<sup>1</sup> The travel times for longitudinal pulsed ultrasonic beam to travel over a given distance of the specimen are measured and the velocity computed. All measurements were made at room temperature and with no confining pressure other than that of the atmosphere. Velocities are measured in a direction parallel to the compression and they are found to increase with increasing pressure. Compressional velocities in Km./sec. at  $P = 0$  ( $V_{P=0}$ ) and  $P = 4,000$  lb./sq. inch ( $V_{P=4000}$ ) in a few Indian rocks, together with their localities, densities in g./c.c. ( $\rho$ ), length ( $l$ ) in cm., travel times in microseconds ( $\mu_s$ ) are given in Table I. The pressure noted in this table is not the one on the pump pressure gauge but is the one on the sample.

The results show that there is a considerable variation in the velocity even within the low

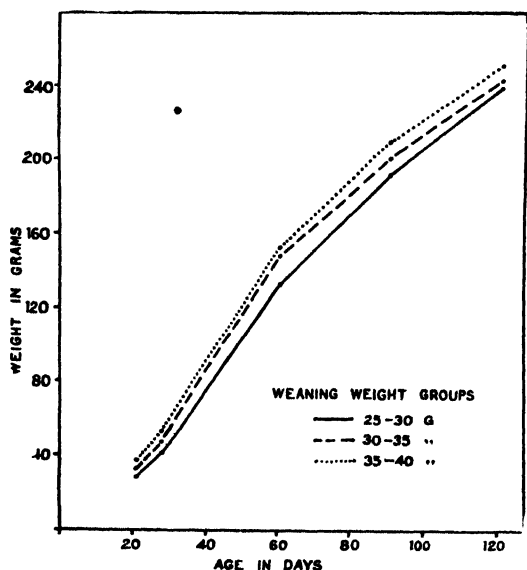

FIG. 1. Influence of weaning weight on the subsequent growth rate of albino rats.

heavier animals was consistently above that of the lighter ones. It is interesting to note that the weight differences existing at weaning

TABLE I

Rock	Locality	$\rho$	$l$	$\mu_s$	$V_{P=0}$	$V_{P=4000}$
Granite	.. Hyderabad	2.66	9.50	15.15	6.26	6.31
Deccan trap	.. Ajanta	3.02	6.40	10.00	6.40	6.55
Charnokite	.. Pallavaram	2.75	5.15	8.45	6.11	6.20
Limestone	.. Shabbad	2.70	5.49	8.40	6.52	6.60
Sandstone	.. Orissa	2.12	7.19	17.40	4.10	4.40
Marble	.. Manditog	2.83	8.52	11.8	7.16	7.30

pressure region. The variation in sandstone is very appreciable and is as much as about 8%. This is to be attributed to the high porosity in comparison with the other rock types.

The author desires to express his grateful thanks to Professor Francis Birch for offering facilities in the Dunbar Laboratory, Harvard University, where this work was done and for his guidance.

Geology Dept.,

S. BALAKRISHNA.

Osmania University,

Hyderabad, March 23, 1958.

1. Don Tocher, *Trans. Amer. Geophys. Union*, 1957, 38, 1.

### ON THE BACTERIOLOGICAL STUDY OF TONED MILK

AN investigation was carried out to study the standard plate counts of toned milk, raw and pasteurised by both laboratory and HTST methods at the Haringhata Farm. Samples of raw toned milk were taken from the bulk milk generally between 1 to 2 P.M. After the milk was pasteurised by HTST method at 170° F. for 30 seconds samples were taken from the sealed bottles. The first sample was taken between 2 to 3 P.M., and the second sample was taken between 3 to 4 P.M. as convenient. All the

above samples were again pasteurised in the laboratory, re-pasteurisation being carried out from the sealed bottle. The test-tube method was followed in laboratory pasteurisation. Standard agar media was used for plating.<sup>1</sup> The plating was done in duplicate and the poured plates were incubated at 37° C. for 48 hours before the reading was taken. The investigation was carried out in March and April 1954.

#### RESULTS AND DISCUSSION

From the above figures, it was noted that the toned milk after laboratory pasteurisation showed the average bacterial count of 7,400 per c.c., which represented the thermoduric and thermophilic organisms present in the raw milk.

The same milk pasteurised by the HTST method showed the average bacterial count 18,200 per c.c., which again on re-pasteurisation in the laboratory showed the average count of 7,100 per c.c. Thus the count of 7,100 per c.c., which is very near to 7,400 per c.c. obtained in case of laboratory pasteurised milk, showed the presence of thermophilic and thermoduric organisms in the re-pasteurised milk. Obviously the count of 18,200 per c.c. was due to contamination from the various equipments of the pasteurisation plant, e.g., pipelines, reservoirs, bottle-filling machine,

TABLE I  
Results of bacteriological analysis of raw and pasteurised toned milk

Test	Raw toned milk	Laboratory pasteurised milk	Pasteurised Milk			
			First sample		Second sample	
			Machine pasteurised milk (sealed bottle)	Re-pasteurised milk from sealed bottle	Machine pasteurised milk (sealed bottle)	Re-pasteurised milk from sealed bottle
			Number of colonies per ml.			
Standard Plate Count						
Maximum ..	31,50,000	9,200	23,600	8,500	31,000	9,400
Minimum ..	8,50,000	3,300	15,000	3,000	19,000	3,400
Average of 30 samples	16,20,000	7,400	18,200	7,100	21,500	7,800

bottle, etc. The same thing was noted in the second sample. Another thing was seen in the second samples of pasteurised toned milk (sealed bottle) that they always showed higher counts than that of the previous ones, the possible cause of which might be due to accumulation of bacteria during the running of the plant, specially the bottle-filling machine.

\*Dairy Farm, SATYA RANJAN SARKAR.  
Haringhata, February 19, 1958.

1. Mackie, T. J. and McCartney, J. E., *Handbook of Practical Bacteriology*, 7th Ed. E. and S. Livingstone, Ltd., 1945, 306.

\* Present Address: Public Health Laboratory, Darjeeling.

### A NOTE ON GAFFKYA SPECIES ISOLATED FROM INDIAN EARTH- WORM

*Bergey's Manual*<sup>2</sup> provides key to only two species in the genus *Gaffkya* and refers the habitat of both as the animal body. The bacteria are pointed out to be parasitic, Gram positive and occurring as tetrads in the animal body and in special media only, while in ordinary culture media they are said to occur in pairs and irregular masses. The only other *Gaffkya* species described in the literature is also of animal origin and, in fact, has been reported to be pathogenic for the American lobster and as such named *Gaffkya homari*.<sup>5</sup> Thus all the three known species have animals as their habitat and are stated to be either white or greyish white in appearance on culture media.<sup>1,2,5</sup> The nomenclatural vicissitudes of the genus and the inadequacy of its definition have justly been the subject of a detailed discussion by Aaronson.<sup>1</sup> In this note is given, for the first time, the description of a yellow pigmented, aerobic, micrococcus isolated from earthworm intestines which, under the available system of classification and nomenclature, has to be placed in the genus *Gaffkya*. Perhaps, in course of time, if more strains are isolated and studied the organism would merit a specific name—*Gaffkya pheretima*—inasmuch as the 11 isolates thus far studied were derived from the alimentary canal of Indian earthworms, mostly *Pheretima* species. It is interesting to observe that even this species has as its habitat the animal body, though it is rather unfortunate that pathogenicity studies could not be carried out before a typical strain of this organism, maintained by us, was inadvertently lost.

It has been reported earlier<sup>4</sup> that of the 16 micrococci isolated from the intestinal contents of earthworms on nutrient agar, 4 were starch hydrolysing variants of *Micrococcus aurantiacus* and 1 *Micrococcus* sp. The remaining 11 were referred to as *Gaffkya* sp. as they were observed to be typical tetrads, even on ordinary media like nutrient agar. Details of the isolation procedures may be found elsewhere.<sup>3,4</sup> Relevant characteristics, which should prove to be of help in referring similar other isolates to this bacterium are presented in this note. It will be clear from the description afforded that the species under report differs substantially from other *Gaffkya* described so far and, perhaps, represents a new species.

**Morphology:** Typical tetrads, 0.8-1.0  $\mu$  diameter; non-spore-forming; non-motile and non-capsulated; Gram positive.

**Growth on Nutrient Agar:** At 25-27° C. in 2 days, 1.5-2.0 mm. round, smooth, convex, entire, lemon-yellow colonies.

**Nutrient Broth:** Thin, pale yellow pellicle, yellow ring, heavy turbidity near surface and pale yellow to yellow, granular or viscid sediment.

**Hydrogen Sulphide:** Not formed; one strain formed H<sub>2</sub>S after 8 days.

**Indole:** Not formed.

**Nitrates:** Not reduced.

**Litmus Milk:** No change.

**Milk Agar:** Casein slightly hydrolysed.

**Gelatine:** Liquefied.

**Catalase:** Present.

**Ammonium Phosphate:** Not utilised.

**Sugar Media:** Acid in maltose but not in lactose, glucose, sucrose, mannite, dextrin, starch and glycerine; one strain formed acid in dextrin also.

Microbiology Dept., S. R. KHAMBATA.  
St. Xavier's College. J. V. BHAT.\*  
Bombay-1, March 17, 1958.

\* Present Address: Fermentation Technology Laboratory, Indian Institute of Science, Bangalore 3.

1. Aaronson, S. T., *J. Gen. Microbiol.*, 1956, **15**, 478.
2. Breed, R. S., Murray, E. G. D. and Hitchens, A. P., *Bergey's Manual of Determinative Bacteriology*, 1948, 6th Ed., Williams & Wilkins Co., Baltimore, Md.
3. Khambata, S. R. and Bhat, J. V., *J. Bact.*, 1953, **66**, 505.
4. — and —, *Archiv. f. Mikrobiol.*, 1957, **28**, 89.
5. Snieszko, S. F. and Taylor, C. C., *Science*, 1947, **105**, 500.

**SYNTHESIS OF 7, 10-DIMETHOXY-5, 6, 11, 12-TETRAHYDRO NAPHTHACENE-6, 12-DIONE**

RECENTLY a number of antibiotics<sup>1</sup> and quinones<sup>2</sup> have been isolated from mould metabolites which are hydronaphthacene derivatives. Terramycin (I) and related antibiotics are octahydronaphthacene derivatives while pyrromycinones (II) isolated by Brockmann from actinomycetes are hydroxynaphthacene quinones.

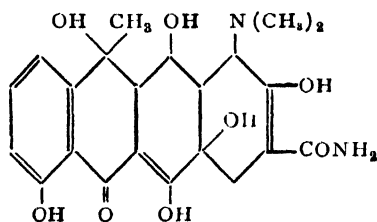

I

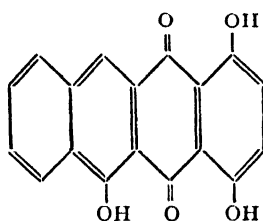

II

COOR.

A few attempts have been made in the past to synthesise hydronaphthacenes by hydrogenating naphthacenes, naphthacene quinones<sup>3</sup> or using tetralin<sup>4</sup> as a starting material and building up the remaining part of the molecule. Very recent trend<sup>5</sup> is to build up molecules having chelating properties similar to tetracyclines. Gates and Dickenson<sup>6</sup> have recently reported the synthesis of a hydronaphthacene derivative. Older methods, however, are of limited application for the synthesis of substituted hydronaphthacenes and hence attempts are being made in this laboratory to develop new methods for their synthesis. The present communication records a preliminary investigation in this field.

5, 8-Dimethoxy-1-tetralone prepared by the modified method of Shah, Shah and Kulkarni<sup>7</sup> was condensed with orthophthalaldehydic acid to give 2-(2'-carboxy-benzylidene)-5, 8-dimethoxy-1-tetralone (III a): crystallized from alcohol, m.p. 166-67° C. (Found: C, 71.2; H, 5.1%. C<sub>20</sub>H<sub>18</sub>O<sub>5</sub> requires C, 71.0; H, 5.3%); 2, 4-dinitrophenyl hydrazone crystallized from acetic acid, m.p. 236° C. (Found: C, 59.9; H, 4.6; N, 11.1%. C<sub>26</sub>H<sub>22</sub>N<sub>4</sub>O<sub>8</sub> requires C, 60.2;

H, 4.3; N, 10.8%.) A mixed m.p. with the 2, 4-dinitrophenyl hydrazone described below showed no depression, thus showing that during hydrazone formation in presence of acid, lactonization also took place.

Attempts to cyclize (III a) to the corresponding 5, 6, 11, 12-tetrahydronaphthacene-6, 12-dione (IV) with concentrated sulphuric acid resulted in the formation of the lactone (V); crystallized from benzene, m.p. 156-57° C. (Found: C, 70.8; H, 5.4%. C<sub>20</sub>H<sub>18</sub>O<sub>5</sub> requires C, 71.0; H, 5.3%); 2, 4-dinitrophenyl hydrazone crystallized from acetic acid, m.p. 235-36° C. (Found: C, 60.0; H, 4.0; N, 10.5%. C<sub>26</sub>H<sub>22</sub>N<sub>4</sub>O<sub>8</sub> requires C, 60.2; H, 4.3; N, 10.8%.)

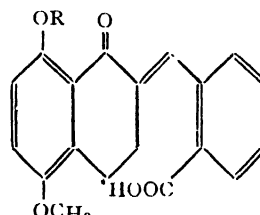
III a; R=CH<sub>3</sub>

III b; R=H

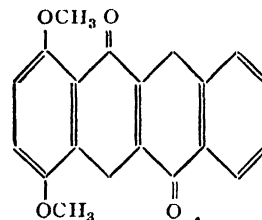

IV

Cyclization of (III a) through the acid chloride with anhydrous aluminium chloride gave a tarry material. The new condensing reagent phosphorus oxychloride-zinc chloride so successfully used in the synthesis of xanthones by Shah<sup>8</sup> and co-workers gave 2-(2'-carboxy-benzylidene)-5-methoxy-8-hydroxy-1-tetralone (III b); crystallized from alcohol, m.p. 145° C. (Found: C, 69.8; H, 5.2%. C<sub>19</sub>H<sub>16</sub>O<sub>5</sub> requires C, 70.3; H, 4.9%.) The acid (III a) was at last cyclized in very poor yields to the corresponding hydronaphthacene (IV) by polyphosphoric acid. The naphthacene derivative was isolated as bis-2, 4-dinitrophenyl hydrazone; crystallized from acetic acid, m.p. 230-31° C. (decomposition). (Found: C, 56.5; H, 3.7; N, 16.3%. C<sub>32</sub>H<sub>24</sub>N<sub>8</sub>O<sub>10</sub> requires C, 56.5; H, 3.5; N, 16.5%.)

The structure of the lactone (V) is (Va) as on reduction with lithium aluminium hydride it gave a diol, without the carbonyl group or a double bond in conjugation with the benzene

ring system, isolated as diacetate (VI); crystallized from alcohol, m.p. 191° C. (Found: C, 69.9; H, 6.5%.  $C_{24}H_{20}O_6$  requires C, 70.1; H, 6.3%  $\epsilon_{\lambda^{atc.}}$  max. 292  $m\mu$ ,  $\log \epsilon$  3.696.)

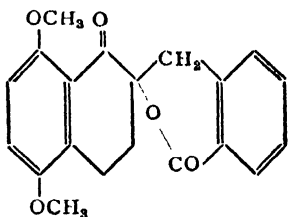

V a

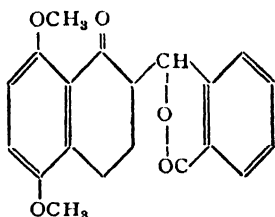

V b

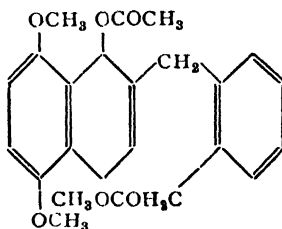

VI

Further the partial reduction of the carbonyl group of the benzylidene tetralone (III a), leaving the double bond in tact, for closing up the ring at 3-position of the tetralone, as was done by Sukh Dev<sup>9</sup> in case of  $\Delta^3$ -octahydro-1-oxo-3-carbomethoxyazulene, was attempted by using sodium borohydride when 2-(2'-carboxybenzylidene)-5, 8-dimethoxy tetrahydronaphthalene-1-ol (VII) was formed. It was isolated as corresponding lactone (VIII); crystallized from alcohol, m.p. 151-52° C. (Found: C, 74.5; H, 5.8%.  $C_{20}H_{18}O_4$  requires C, 74.5; H, 5.6%.) Attempts to enforce the conversion of this lactone<sup>9</sup> to the corresponding tetrahydronaphthalene, were fruitless.

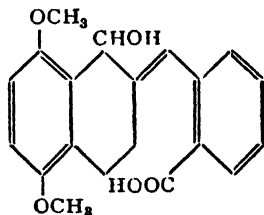

VII

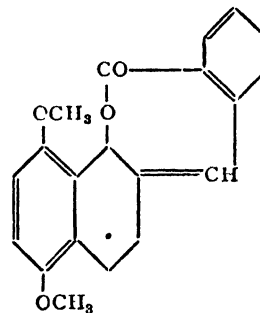

VIII

Experiments are in progress using hydroaromatic aldehydes and substituted tetralones. These and stereochemical investigation in this field would be reported elsewhere.

Chemistry Department, A. L. PANDIT.  
Institute of Science, A. B. KULKARNI.  
Bombay-1, January 22, 1958.

1. Woodward, E. B. and Co-workers, *J. Amer. Chem. Soc.*, 1953, **75**, 5455.
2. Brockmann, H., *Angewandte chemie*, 1957, 477.
3. Braun, V., *Ann.*, **459**, 287.
4. Tetralin, G. M. B. II., *Ger.*, 346, 673.
5. (a) Shemvakin, M. M. and Co-workers, *Dok Akad. Nauk S.S.S.R.*, 1957, **112**, 669.  
(b) Smisman, E. E. and Gabbard, R. B., *J. Amer. Chem. Soc.*, 1957, **79**, 3203.  
(c) Erlenmeyer, H. and Co-workers, *Helv. Chim. Acta.*, 1957, **40**, 1157.
6. Gates, M. and Dickenson, C. (Jr.), *J. Org. Chem.* 1957, **22**, 1398.
7. *M.Sc. Thesis* of V. R. Shah to the University of Poona, 1956, p. 6.
8. Shah, R. C. and Co-workers, *Chem. and Ind.*, 1955, 62.
9. Sukh Dev, *J. Ind. Chem. Soc.*, 1955, 255.

#### TOCOPHEROL CONTENT AS AN INDEX OF ADULTERATION OF GHEE

EMMERIE (1940), Lieck and Willsteadt (1945), Reinart (1949), Bird *et al.* (1951), Anglin *et al.* (1955), and Narayanañ *et al.* (1956) have reported that the tocopherol content of butterfat lay between 10  $\mu\text{g./g.}$  and 45  $\mu\text{g./g.}$  of fat. Some other workers (Emmerie and Engel, 1943; Hove and Hove, 1945; Fisher, 1945; Ramamurthy and Banerjee, 1950) have analysed groundnut and sesame oils and reported a value as high as 200  $\mu\text{g./g.}$  of fat. Mahon *et al.* (1955) have indicated that tocopherol estimation may prove useful in detecting adulteration of milk products like condensed milk, ice-cream and cheese. Information on the tocopherol content of Indian edible oils is scanty; estimation of

tocopherol in ghee is likely to indicate the extent of adulteration. Results obtained to check the hypothesis are presented in this article.

## EXPERIMENTAL

Cream ghee was prepared by clarification of cream from cow and buffalo milk at 115° C. Coconut, groundnut, sesame and hydrogenated groundnut oils were obtained from the market in fresh condition. The tocopherol contents of a dozen samples of ghee and of each oil were estimated by the method reported by Narayanan *et al.* (1956). The fats were saponified with alcoholic potash in presence of pyrogallol and the unsaponifiable matter was dissolved in benzene (A.R., thiophene free). The carotene and vitamin A were removed by passing through a column of freshly activated floridin earth. The benzene filtrate was evaporated under reduced pressure and the residue dissolved in warm alcohol. Ferric chloride and  $\alpha\alpha$ , dipyridyl solutions in alcohol were added in succession and the red colour developed in 2 min. was measured colorimetrically. The results obtained are presented in Table I.

TABLE I  
Tocopherol content of common edible oils

Fat	Tocopherol content $\mu\text{g./g. fat}$			Peroxide value ml 0.002N. Thio./g. fat
	Maximum	Minimum	Average	
Cow ghee	44.0	23.5	34.8	0.1
Buffalo ghee	36.7	18.0	25.9	0.1
Coconut oil	42.0	26.6	35.1	0.3
Hydrogenated				
groundnut oil	288.7	213.9	246.1	0.2
Sesame oil	290.9	199.2	241.5	0.5
Groundnut oil	330.6	228.6	255.9	0.6

Ghee was adulterated at 5, 10, 15, 20, and 25% levels with groundnut and hydrogenated groundnut oils and tocopherol contents of original ghee and adulterated mixtures estimated and the results are shown in Table II.

From Table I, the tocopherol content of ghee and coconut oil ranged between 20.6  $\mu\text{g./g.}$  and 44.5  $\mu\text{g./g.}$  of fat, whereas other vegetable oils showed much higher values (over 190  $\mu\text{g./g.}$ ).

The tocopherol content of ghee increases with increasing admixture with extraneous vegetable fat (Table II). Five % adulteration increased the tocopherol value to as high as 45.7  $\mu\text{g./g.}$  in cow ghee. A 10% addition to ghee caused an increase of nearly over 57% in cow ghee and 83% in buffalo ghee in the tocopherol contents. Addition of foreign fat to the extent of 20% to cow ghee and 15% to buffalo ghee almost doubled the tocopherol content. Of course, the natural variation of tocopherol con-

TABLE II  
Tocopherol content of adulterated ghee  $\mu\text{g./g.}$

Adulteration %	Adulteration with			
	Hydrogenated groundnut oil		Groundnut oil	
	Experimental value	% increase	Experimental value	% increase
	Cow Ghee			
0	35.5	..	35.5	..
5	45.7	28.7	45.6	28.4
10	56.0	57.7	56.7	59.7
15	66.2	86.5	65.9	85.6
20	76.3	114.9	76.2	114.8
25	86.5	143.6	86.5	143.6
	Buffalo Ghee			
0	28.6	..	25.6	..
5	36.2	41.4	36.0	40.6
10	47.0	83.6	46.9	83.2
15	57.6	125.0	57.5	124.6
20	68.2	166.4	68.1	166.0
25	79.0	208.6	78.8	207.8

tent in ghee (20-45  $\mu\text{g./g.}$ ) limits the detection of adulteration below 10%. It is also noteworthy that hydrogenated oils also have high tocopherol contents. Where the analytical data of ghee are suspicious of adulteration, a determination of tocopherol content may prove useful. Adulteration with coconut oil will escape detection by this method.

The authors are thankful to the Director of Dairy Research for his keen interest in the work.

R. A. RAMANUJAN.

C. P. ANANTAKRISHNAN.

Southern Regional Station,  
National Dairy Research

Institute, Bangalore, February 10, 1958.

1. Anglin, C., Mahon, J. H. and Chapman, R. A., *J. Dairy Sci.*, 1955, **38**, 333.
2. Bird, E. W., Patel, D. J. and Handweck, R. L., *Ibid.*, 1951, **34**, 484.
3. Emmerie, A., *Rec. Trav. Chim. Pays. bas.*, 1940, **59**, 246.
4. — and Engel, C., *Zts. Vitamin Forsch.*, 1943, **13**, 239.
5. Fisher, G. S., *Ind. Eng. Chem. Anal. Ed.*, 1945, **17**, 224.
6. Hove, E. and Hove, C. A., *J. Biol. Chem.*, 1944, **156**, 601.
7. Lieck, K. R. and Willsteadt, H., *Svensk. Chem. Tid.*, 1945, **57**, 134.
8. Mahon, J. H., Anglin, C. and Chapman, R. A., *J. Dairy Sci.*, 1955, **38**, 1089.
9. Narayanan, K. M., Anantkrishnan, C. P. and Sen K. C., *Indian J. Dairy Sci.*, 1950, **9**, 44, 86.
10. Ramamurthy, K. and Banerjee, B. N., *Indian J. Med. Res.*, 1950, **38**, 377.
11. Reinart, A., *Proc. 12th Intern. Dairy Cong.*, 1949, **2**, 405.

**FRUCTOSE-GLUCOSE RELATION DURING VEGETATIVE AND REPRODUCTIVE STAGES IN SUGARCANE**

IN an earlier communication<sup>1</sup> fructose was reported to exist in greater amounts than glucose in mature cane juices. In this note are presented certain characteristic trends in the relative concentrations of fructose and glucose in juices of early-flowering (Co.285) and late-flowering (Co.290) cane varieties recorded at specific stages of their growth and development.

Six to eight uniformly growing main shoots of similar physiological age were collected every time from each variety between 8-30 and 9-00 A.M. and juice extracted—sampling commencing from August 13, 1956, when the plants were six-months-old. Sucrose was estimated by the usual double polarisation method while fructose and glucose were determined according to the micro method of Van Der Plank<sup>2</sup> adopting the modification for the calculation of glucose in presence of fructose.<sup>1</sup> The errors due to sampling were so minimised that the magnitude of error between any two samples was never more than 3-5%.

In Table I are given the percentages (on juice weight basis) of fructose, glucose and

cose values increase rapidly during symptom and short blade stages (ascending arrow) and fall steeply during arrowing stage (descending

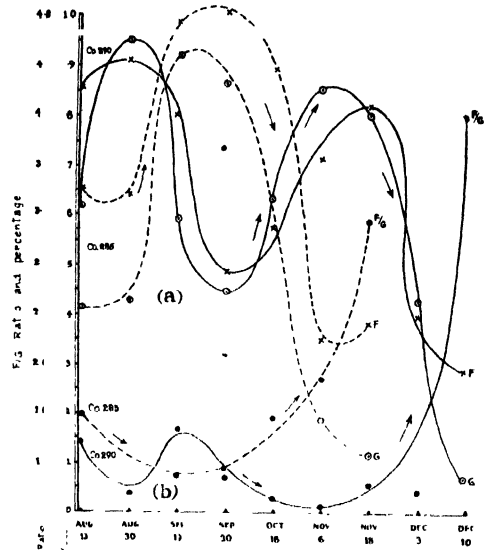

FIG. 1

arrow). Characteristically the F/G ratio (Fig. 1 b), shows the opposite trend. In the late-flowering variety Co. 290, the period of

TABLE I

Co. 285 (Early flowering)					Co. 290 (Late flowering)					
Date of Sampling	Stage at the time of sampling	Fructose (F)	Glucose (G)	F/G	Sucrose	Stage at the time of sampling	Fructose (F)	Glucose (G)	F/G	Sucrose
(Percentages on Juice-weight basis)										
13 August	.. Veg.	0.65	0.41	1.59	8.43	Veg.	0.85	0.61	1.39	6.2
30 August	.. Veg.	0.64	0.42	1.52	8.86	Veg.	0.91	0.95	0.96	7.43
19 September	.. Veg.	0.98	0.92	1.07	9.29	Veg.	0.80	0.59	1.36	9.96
30 September	.. Sym.	1.01	0.86	1.17	10.14	Veg.	0.48	0.44	1.09	10.33
18 October	.. S.B.	0.89	0.57	1.56	9.87	Veg.	0.57	0.63	0.90	9.40
6 November	.. Arrowed	0.35	0.19	1.84	13.21	Veg.	0.71	0.85	0.84	8.07
18 November	.. Arrowed	0.38	0.12	3.17	14.16	Veg.	0.81	0.80	1.01	7.11
3 December	.. ..	..	..	..	..	Sym.	0.39	0.42	0.93	13.13
10 December	.. ..	..	..	..	..	Arrowed	0.28	0.07	4.00	15.00

Veg. = Vegetative. Sym. Symptom. S.B. = Short Blade.

sucrose in juices of the two cane varieties at specific stages of vegetative growth and flowering. The fructose/glucose ratios are given separately. In Fig. 1 is shown the general trend of the variation in fructose-glucose concentration during vegetative, symptom, short blade and arrowed stages of the two cane varieties.

In the early-flowering variety Co.285 (Fig. 1 a, notched line) the fructose and glu-

vegetative growth is prolonged and the rapid vegetative growth during this period is characterised by relatively high values in fructose and glucose with corresponding low values for F/G ratio. The trend of the fructose and glucose, and F/G values is similar as in Co.285 during short blade and arrowing stages. In the early-flowering variety Co.285, the rapid vegetative growth period is completed prior to the six months stage of the plants and hence the



high values in fructose and glucose as seen in Co. 290 are not evidenced.

Fructose values relative to glucose values appear to bring out an important point in the metabolism of the sugarcane plant. Fructose in sugarcane seems to be utilised relatively in greater quantities as compared to glucose during the rapid vegetative, initiation and short blade stages while it tends to accumulate or is in lesser demand at arrowing stage. Another point of interest is that, with the arrowing, the high sucrose per cent. is followed by a rapid decrease in the hexose sugars (F and G) and a very high value for F/G ratio. This characteristic may be a very good index of maturity in sugarcane.

Fuller details of the paper will appear elsewhere.

Thanks are due to Shri S. Ramakrishnan, Junior Assistant, for assistance, and to Shri N. L. Dutt, M.Sc., F.A.Sc., Director, for kind interest in these investigations.

Sugarcane Breeding Inst., K. PARTHASARATHI.  
Post Lawley Road, M. VIJAYASARADHY.  
Coimbatore, February 21, 1958.

1. Parthasarathi, K. and Vijayasaradhy, M., *Proc. 3rd Bien. Conf. Sugarcane Res. and Develop. Workers, India, 1957, Part 1, B-15.*
2. Van Der Plank, J. E., *Biochem. Jour.*, 1936, **30**, 457.

### A NEW BACTERIAL BLIGHT OF *CYAMOPSIS TETRAGONOLOBA* (L.) TAUB.

A DETAILED microscopic examination of a severe leaf-blight on *C. tetragonoloba*, found in August 1957, on the Agricultural College Farm, Anand, revealed yellow masses of bacteria oozing out from the affected leaf-tissues. The symptoms of the disease very much resemble those produced by *X. campestris*. The pathogen enters the leaf chiefly through hydathodes where it produces irregular, V-shaped pale-yellow spots of various sizes on the leaf-borders. The spots gradually increase in size when the central portion becomes pale-brown accompanied by a yellow water-soaked border. Under a severe attack, the entire leaf-border gets infected, the leaves shrivel, droop and die. Under ideal condition of infection as they occur under high humidity and low temperature (July-January), the infection becomes systemic as the pathogen migrates to the leaf-veins and makes its way as far as the stem through leaf-petiole. As a result, defoliation from the base upward is quite common. Lower leaves which are naturally shaded by the upper ones show

heavier infection. Infection on the flower, the pod and the stem is not so far observed.

**Morphology.**—The organism is a short rod, single, rarely in pairs, gram-negative, not acid-fast, non-spore-former, capsulated, motile by a polar flagellum, yellowish and stains readily with common dyes. In 48-hour-old culture grown on potato dextrose agar at 27° C., the size of the cells is 1.2-1.5 × 0.4-0.6 μ.

**Cultural and Physiological Characters.**—On potato dextrose agar plates, the colonies are smooth, pulvinate, glistening with entire margins, consistency butyrous, 12 mm. in 6 days, striations from a central ring of about 3 mm., naphthalene yellow (Ridgway), border 0.5 mm. light-coloured; on slant, growth abundant, smooth, convex, glistening, butyrous, no striations, naphthalene yellow (Ridgway), border light-coloured, flowing; on cylinders, growth copious, flowing, shining, convex, covering the entire surface in 4 days, colour of the cylinder not changed, martius yellow (Ridgway), no odour, smooth filiform. On nutrient agar plates, colonies flat, poor in growth, smooth, glistening, with entire margins, straw colour (Ridgway), no striations, not butyrous, 6 mm. in 6 days, border 0.5 mm. light in colour; on slant, growth fair, flat, baryta yellow (Ridgway), entire slant not covered, filiform, no odour, in broth, very good growth within 24 hours, ring present, no floccules, no pellicle and no sediment; on dextrose plates, colonies smooth, convex, shining with entire margins, consistency butyrous, with striations, 9 mm. in 6 days, mustard yellow; on dextrose slant, excellent growth, flowing, filiform, no odour, entire surface covered, wax yellow; in dextrose broth, heavy growth within 24 hours, heavy ring, no floccules, no pellicle and no odour. Plain and litmus milk not affected; gelatin liquefied; starch and casein hydrolysed; H<sub>2</sub>S produced; nitrates not reduced, NH<sub>3</sub> from nitrates or peptone not produced; indole not produced; Loeffler's blood serum liquefied in 4 days. Acid but no gas from dextrose, lactose, maltose, mannitol, glucose, xylose; no growth in salicin; alkaline reaction from acetic and citric acids; optimum growth at 25-27° C.; thermal death-point at about 51° C.; facultative anaerobe; sodium chloride tolerant upto 3%; pathogenic only to hairy and glabrous varieties of *C. tetragonoloba*.

Since no bacterial blight has been reported on *C. tetragonoloba* so far and since it does not infect other related plant species, it is proposed to name the pathogen *Xanthomonas cyamophagus* nov. sp.

Further details will be published elsewhere.  
Plant Path. Lab.,  
College of Agriculture,  
Anand, March 1, 1958.

A. J. PATEL.  
M. K. PATEL.

height of about 4,200 ft. above the sea-level, its highest peak Gurishikar being 5,653 ft. above the sea-level. The rainfall is usually heavy, average being 61" to 65" annually and many shady types which are uncommon in neighbouring plains are met with here. The rainy season extends from about the month of June to middle of September during which liverworts and mosses are very common, occurring in different habitats.

**A NOTE ON HEPATIC FLORA OF  
MT. ABU**

MT. ABU is the richest spot for vegetation in Rajasthan. It is situated between 24° 31'-24° 43' N. and 72° 38' to 72° 53' E. at an average

Types		Localities	Habitat
<b>ANTHOCEROTALES</b>			
<b>ANTHOCEROTACEÆ</b>			
1. <i>Anthoceros himalayensis</i> Kash.	..	Very common	Moist and shady places
2. <i>Anthoceros erectus</i> Kash.	..	Behind Sirohi Kothi, Sunset point	Moist ground with mosses
3. <i>Phæoceros</i> sp. <i>Notothylas</i> Shull	..	Near Kodra dam	Moist soil
4. <i>Notothylas levieri</i> Schiff.	..	Kumarwara and Sunset point	Moist soil in patches
<b>MARCHANTIALES</b>			
<i>Marchantia</i> L.			
5. <i>Marchantia polymorpha</i> L.	..	Craigway	Moist Rock
6. <i>Asterella</i> Beauv.	..	Very common	Dry and moist soil or rocks on bark of trees
7. <i>Asterella Blumeyana</i> Nees	..	Common	Moist ground and rocks
8. <i>Plagiochasma articulatum</i> Kash.	..	Very common	On moist soil, walls of old buildings
9. <i>Plagiochasma apendiculatum</i> L. et L.	..	Very common	Moist dry ground on walls, buildings, rocks and bark of trees
<b>TARGIONACEÆ</b>			
<i>Cyathodium</i> Kunge			
10. <i>Cyathodium tuberosum</i> Kash.	..	Very common	In moist and shady places usually in patches
11. <i>Cyathodium baroda</i> Chavan.	..	Naki Lake, Achalgarh	On moist soil
12. <i>Targionia hypophylla</i> L.	..	Most common	On moist soil, rocks, walls of old houses, bark of trees
<b>RICCIACEÆ</b>			
<i>Riccia</i> (Mich.) L.			
13. <i>Riccia fluitans</i> L.	..	Tank near Municipal Park	Banks of water where soil is very moist or actually under water
14. <i>Riccia himalayensis</i> St. ( <i>R. discolor</i> L. et L.)	..	Common	Moist soil and rocks
15. <i>Riccia frostrii</i> Aust.	..	Sunset point, behind Sirohi Kothi, Achalgarh	On banks of water
16. <i>Riccia crystallina</i> L.	..	Oriya, Kodradam Dilwara	Moist ground and rocks
17. <i>Riccia gangetica</i> Ahmad	..	Sunset point, Naki Lake, Achalgarh	Moist soil
18. <i>Riccia plana</i> Taylor	..	Anadhra point, Sunset point	Moist ground
19. <i>Riccia billardieri</i> Mont.	..	Kumarwara St. Mary High School	Moist soil and rocks
20. <i>Riccia aravalliensis</i> *	..	Sunset point, Naki Lake	Moist ground
<b>JUNGERMANNIALES</b>			
<b>ANACROGYNÆ</b>			
<b>ANEURACEÆ</b>			
<i>Metzgeria</i> Raddi			
21. <i>Metzgeria himalayensis</i> Kash.	..	..	In moist places among mosses
<b>CODONIACEÆ</b>			
22. <i>Pellia epiphylla</i> Lindl.	..	Behind Sirohi Kothi, near Hanuman Temple, on way to Gaumukh	Near flowing water
23. <i>Calyculularia crispulla</i> Mitt.	..	Hanuman Temple, Gaumukh	Moist soil
24. <i>Fossombronina himalayensis</i> Kash.	..	Sunset point	Moist soil with mosses

\*While identifying some of my collections Dr. S. K. Pandé found it to be a new species. He has named it after Aravalli Hills.

Liverworts of Mt. Abu have received considerably little attention. Mahabalé and Chavan (1945) while describing Hepatics in Gujarat, and Mahabalé and Kharadi (1946), describing the ecological vegetation of Mt. Abu, mention (i) *Plagiochasma appendiculatum* L. & L., and (ii) *Riccia discolor* L. & L. The writer during his visits in different seasons to Abu has been able to collect following species of liverworts and various mosses from different localities. It is expected that many more may be found on further exploration of the vegetation of the place.

It will be seen from the above that the genera, particularly belonging to either Marchantales or Anthocerotales, like species of *Riccid*, *Fimbriaria*, *Targionia*, *Plagiochasma* and *Anthoceros* are widely distributed and found in various types of habitats.

The climate and edaphic factors favour the growth of liverworts but Abu often being dry for the greater part of the year, only those species are found here which can either resist the draught or can mature within a short period of 2 to 3 months. Probably Mt. Abu presents the Hepatic flora similar to that found in the hills of the Western or drier Himalayas. It is interesting to note that out of 24 species from Abu listed above, many are found in the Western Himalayas and South India. Hence Abu may be expected to present a hepatic vegetation intermediate between that of the Western Himalayas and South India and may form a connecting link between the two.

The author is highly grateful to Dr. P. N. Mehra for his valuable help and advice. I am also thankful to Mr. R. S. Chopra and Dr. S. K. Pandé for help in identifying some of the collections.

Lecturer in Botany,

K. R. BAPNA.

Jaswant College,

Jodhpur, February 20, 1958.

### A NEW SPECIES OF *CERCOSPORA* ON *BLUMEA LACERA* DC.

IN connection with phytopathological survey of the areas commanded by Hirakud canal system, the common weed *Blumea lacera* DC. was observed to be heavily infected by a *Cercospora* sp. (Fig. 1). This particular fungus,



FIG. 1. Spots on the leaf of *Blumea lacera* DC.

descriptions of which are given below, is found to be very much different in character from *Cercospora blumeæ* de Thuemen,<sup>2,5</sup> recorded in India by Sydow and McRae (1929)<sup>1,4</sup> and *C. blumeæ-balsamiferæ* Sawada,<sup>3</sup> already reported on *Blumea* species.

Spots amphigenous, scattered, first appear as yellow specks but later turn brown and enlarge, 5 mm. (average 1 cm.) to 3 cm. in diameter, circular, often coalescent and irregular, older spots gray-coloured, central tissue necrotic, frequently become shot-holes.

Conidiophores very long, divergent, prostrate or curving down, straight or geniculate, thick-walled, brown-coloured, multiseptate with long internodes, fasciculate or in singles, protruding through stomatal openings, measure 103-(168·67)-426  $\mu$   $\times$  4·5-5  $\mu$ ; conidia hyaline, acicular, acropleurogenous, straight or arcuate, short septate, without oil globules, with hilum at the point of attachment, measure 56-(87·36)-144  $\mu$   $\times$  4·5  $\mu$  (Fig. 2).

*Habitat*: living leaves of *Blumea lacera* DC., 8-11-1956, Hirakud Island and Research Staff Colony premises, Sambalpur, Orissa, Leg. S. N. Das.

Type specimens deposited at the Herbarium of the New York State College of Agriculture, Cornell University; Herb. Crypt. Ind. Orient, I.A.R.I., New Delhi (25884) and at the Commonwealth Mycological Institute, Surrey, England (1. M.I. 67911).

1. Chavan, A. R. and Mahabalé, T. S., *Proc. 32nd Ind. Sci. Cong.*, 1945, 70, 11.
2. Chopra, R. S., "A census of Indian Hepatics," *Jour. Ind. Bot. Soc.*, 1943, 22, (5,6), 229.
3. Evans, A. W., *Bot. Rev.*, 1939, 5, 49.
4. Kashyap, S. R., "Liverworts of the Western Himalayas and the Punjab Plain. Part I," Lahore, 1929.
5. — and Chopra, R. S. "Liverworts of the Western Himalayas and the Punjab Plain, Part II," Lahore, 1932.
6. Mahabalé, T. S. and Kharadi, *Proc. Nat. Acad. Sci. Ind.*, 1946, 11 (6), 13.
7. Pandé, S. K. and Srivastava, K. P., *Jour. Ind. Bot. Soc.*, (1952) 31 (4), 342.
8. — and Ram Údar, *Proc. Ind. Sci. Cong.*, 1957, 231.

*Cercospora blumeicola* DAS, SPEC. NOV.

Maculae amphigenae, dispersae, primo apparentes ut puncta lutca, tandem evadentes brunneae atque dilatatae, diametientes 5 mm. (mediet. 1 cm.) ad 3 cm. circulares, saepe coalescentes atque irregulares, maculis vetustioribus griseis, textu medio necrolico, saepe evadentes cavae.

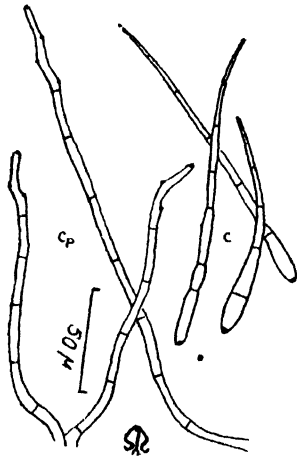

FIG. 2. Conidiophores (Cp.) and Conidia (.) of *C. blumeicola* Das.

Conidiophori longissimi, divergentes, prostrati vel deorsum curvati, recti vel geniculati, crassis parietibus praediti, brunnei, spatiis internodalibus longis, multiseptati, fasciculati vel singuli, emergentes per stomata, magnitudinis 103-(168-67)-426  $\mu$   $\times$  4-5.5  $\mu$ ; conidia hyalina, acicularia, acropleurogena, recta vel arcuata, breviter septata, absque globulis oleaceis, hilo ornata ad punctum junctionis, magnit. 56-(87-36)-144  $\mu$   $\times$  4.5  $\mu$ .

Habitat in foliis viventibus Blumeae lacerae DC. die 8 novembris anni 1956, in insula Hirakund atque in colonia ministrorum investigationis, ad Sambalpur, in Statu Orissa, legit S. N. Das.

Typus positus in herbario collegii Agriculturae in Statu Neo-Eboracensi, in Universitate Cornelliana, in Herb. Crypt. Ind. Orient, I.A.R.I., New Delhi (25884) atque in Commonwealth Mycol. Instit. Surrey in Anglia (1. M.I. 67911).

In view of the divergent, very long conidiophores, hyaline acicular conidia and large gray spots, Dr. C. Chupp of Cornell University, U.S.A., and Mr. Deighton of Commonwealth Mycological Institute, England, considered this fungus to be a new species.

Thanks are due to Rev. Father Dr. H. Santapau, St. Xavier's College, Bombay, for rendering the Latin descriptions; to Dr. U. N. Mohanty,

Deputy Director of Agriculture, Cuttack, for his helpful suggestions and to Shri G. N. Rout, Agricultural Research Officer, Sambalpur, for providing Laboratory facilities.

Section of Mycology, SITANATH DAS,  
Agric. Res. Station,  
Sambalpur, January 13, 1958.

1. Butler, E. J. and Bisby, G. R., *The Fungi of India*, 1931, 141.
2. Chupp, C., *A Monograph of the Fungus Genus Cercospora*, 1953, 124-25.
3. Sawada, K., *Taiwan Agr. Res. Inst. Report*, 1943, 86, 146.
4. Sydow, H. and McKae, W., *Ann. Crypt. East.*, 1929, 2, 263.
5. Thuman, F. V., *Rev. Myc.*, 1980, 2, 36-38.

#### AKINETE FORMATION IN THE GENUS *HORMIDIUM* (KUTZ.) KLEBS.

Two species of the genus *Hormidium*, namely, *Hormidium rivulare* Kütz. and *Hormidium subtile* (Kütz.) Heering, were collected in the vicinity of Nainital. *H. rivulare* was collected in October, 1957, from the exposed concrete footsteps near the Department of Botany and from the soil near the Library of Government College, Nainital, while *H. subtile* was collected in August, 1957, from shallow depressions on the surface of exposed rock. The materials were fixed in 4% formalin at the spot.

The specimens of both species were very interesting as they showed the formation of akinetes. In *H. rivulare* the akinetes were formed either singly (Figs. 1, 2) or in short

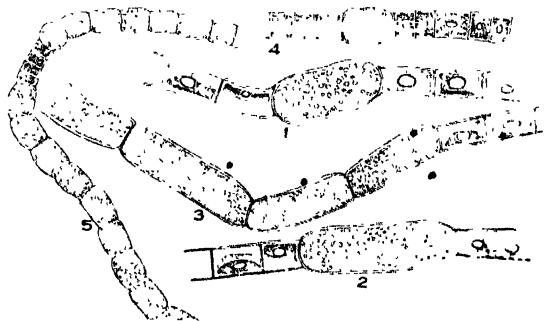

FIGS. 1, 2. Filaments of *H. rivulare*, showing mature ellipsoidal akinetes,  $\times$  200.

FIG. 3. Filament of *H. rivulare*, showing young rectangular akinetes,  $\times$  200.

FIG. 4. Filament of *H. subtile*, showing solitary akinete,  $\times$  200.

FIG. 5. Filament of *H. subtile*, showing akinetes in a long chain,  $\times$  125.

chains of 4-5 (Fig. 3) in a filament. The spores were 3-6 times longer than the vegetative cells. Younger akinetes were rectangular in outline but at maturity they became ellipsoidal with or without a median depression. Mature akinetes were rich in oil content.

In *H. subtilis* the akinetes were usually formed in long chains (Fig. 5) and in most cases nearly all the cells in a filament were transformed into akinetes. In a few cases they were formed singly (Fig. 4). Mature akinetes were usually rectangular but occasionally spherical ones were also met with. The akinetes were thick-walled and looked somewhat pale-green in colour. In some filaments there were colourless akinetes also.

The writer has not come across any description of akinete formation in the genus *Horridium* except a brief reference in Fritsch (p. 206).<sup>1</sup>

To the best of writer's information this is the first record of akinete formation in genus *Horridium*.

Dept. of Botany,  
Th. D. S. B. Govt. College,  
Namtal, U.P.,  
October 8, 1957.

K. P. SINGH.

1. Fritsch, F. E., *The Structure and the Reproduction of the Algae*, 1935, I, Cambridge, p. 791

#### OCCURRENCE OF GROWTH CHECKS IN THE SCALES OF THE INDIAN MACKEREL, *RASTRELLIGER* *CANAGURTA* (CUVIER)\*

AGE and growth studies form an essential part of fishery biological research. Owing to the well-known limitations of the length-frequency method in these studies the need has been frequently felt for other suitable methods. While in the temperate countries scales, otoliths and other bony structures have proved to be useful tools in such work, these structures have not been so readily useful in the tropical countries. But the possibility of the scales or otoliths being useful age-indicators in some species even in tropical waters has been demonstrated by some recent investigations.<sup>1, 2</sup>

The great importance of searching for suitable age and growth indicators in the mackerel was stressed by the *Rastrelliger* Sub-Committee of the Indo-Pacific Fisheries Council at its Penang session in September 1956, in connection with the large-scale researches planned by most of the Indo-Pacific countries on this very important commercial fish of the region.

It was therefore considered useful in this connection to examine the scales of the Indian mackerel (*Rastrelliger canagurta*) and a preliminary investigation on this aspect was taken up by the author in Karwar during the period October-December 1957. While this investigation is now being extended and more material from different parts of the Indian coast is still under examination, it is interesting to report here that the material collected from the Kanara coast during the above period has revealed clear growth checks or rings in the scales of the largest sizes, in the form of breaks in the sculpturing of the scales parallel to and near the margins. In practically all cases† there was only one ring in the scale; in some the upper sculptured layer stopped short of the lower unsculptured layer, the edge of the former marking the ring; but in a large majority of individuals there was a well-marked upper (sculptured) layer also outside the ring, often with a change of pattern.

The accompanying photomicrographs show scales of the Indian mackerel with and without the growth checks.

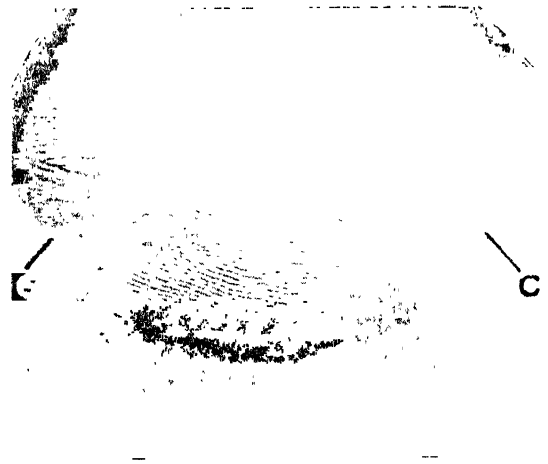

PHOTOMICROGRAPH 1. A scale of *Rastrelliger canagurta*. (Female 24.6 cm, dated 20.11.1957),  $\times 14.5$ . Mark C indicates the growth check.

Three hundred and sixty-nine individuals were examined in all from the North Kanara coast during the above period and the table shows the distribution of the scale rings in the different size-groups examined. It will be noted that rings were completely absent in all individuals below 22.0 cm. in all the three months while all individuals above 23.0 cm. showed clear rings. In the size-groups 22.1-

Months	Sizes (Total length in cm.)	Males		Females		Sex not known		Total	
		Nr. examined	Nr. with clear rings	Nr. examined	Nr. with clear rings	Nr. examined	Nr. with clear rings	Nr. examined	Nr. with clear rings
October	22.0 and below	8	0	9	0	11	0	28	0
	22.1 to 23.0	0	..	1	0	0	..	1	0
	23.1 to 27.0	11	11	15	15	0	..	26	26
	Total ..	19	11	25	15	11	0	55	26
November	22.0 and below	84	0	82	0	8	0	174	0
	22.1 to 23.0	4	1	5	1	2	0	11	2
	23.1 to 27.0	40	40	44	44	0	..	84	84
	Total ..	128	41	131	45	10	0	269	86
December	22.0 and below	16	0	10	0	7	0	33	0
	22.1 to 23.0	0	..	0	..	0	..	0	..
	23.1 to 27.0	4	4	8	8	0	..	12	12
	Total ..	20	4	18	8	7	0	45	12

23.0 cm., twelve specimens were examined; only two of these had clear rings in the scales. What may be described as false rings were occasionally noticed in all sizes but could be

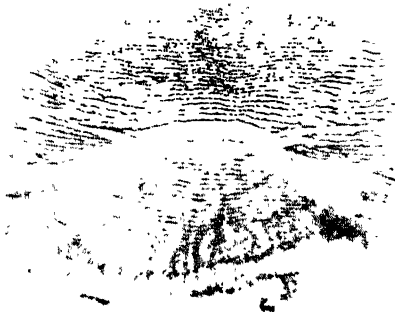

PHOTOMICROGRAPH 2. A scale of *Kastrelliger canagurta* (Male, 20.7 cm, dated 20-11-1957).  $\times 14.5$ , easily distinguished from the usual rings, the number of scales difficult to interpret being small. One is confronted here with a case of regular ring formation only in the larger sizes, the smaller sizes not showing rings although both groups have clearly passed through at least one monsoon. The rings are thus not comparable to the monsoon rings of *Cynoglossus semifasciatus*.<sup>2-4</sup>

Practically all the individuals with clear rings in the scales in the present work were adults in Stage I (or near Stage I) of maturity resting or recovering after a spawning. According to Pradhan<sup>10</sup> and the observations of other workers on the North Kanara coast (unpublished work at the Karwar Unit of the

Central Marine Fisheries Research Station), the spawning season for the mackerel of that coast is generally from June to September; Pradhan<sup>10</sup> also states that the size of the mackerel at first maturity is 22.4 cm. Considering the above distribution of the scale rings in the different sizes in the light of these facts it seems very likely that the rings reported here are spawning marks occurring as a rule in the older individuals and may prove useful not only in age and maturity studies but also in raciation studies in view of the reported variation in the size-distribution and spawning period of the species in different parts of Indian coast.

Central Marine Fisheries Research Station,  
Mandapam Camp, February 27, 1958.

G. SESHAPPA.

\* Published with the permission of the Chief Research Officer, C.M.F.R.S., Mandapam Camp.

\* Three specimens measuring 25.0, 25.4 and 25.7 cm. had two rings in the scales near the margins in December but such cases are still to be studied in detail and are not classified here separately.

1. Nair, R. V., *Curr. Sci.*, 1949, **18**, 9.
2. Seshappa, G. and Bhimachar, B. S., *Ibid.*, 1951, **20**, 260-62.
3. —, *Ind. J. Fish.*, 1954, **1**, 145-62.
4. —, *Ibid.*, 1955, **2**, 180-230.
5. Pillay, T. V. R., *Proc. Nat. Inst. Sci. India*, 1954, **20**, 187-217.
6. Radhakrishnan, N., *Curr. Sci.*, 1954, **23**, 6, 196-97.
7. —, *Ind. J. Fish.*, 1957, **4**, 2.
8. Sarojini, K. K., *Ibid.*, 1957, **4**, 1, 160-207.
9. Jhingran, V. G., *Nature*, London, 1957, **179**, 4557.
10. Pradhan, I. B., *Ind. J. Fish.*, 1956, **3**, 1, 141-82.

### THE SECOND INSTAR LARVAL CUTICLE OF *ATTACUS RICINI*

DURING the last two decades work on the insect cuticle has been carried out by several workers like Wigglesworth,<sup>1,2</sup> Wolfe<sup>3,4</sup> and others. It is now generally recognised that the insect cuticle consists of two fundamentally different layers, the epicuticle and the endocuticle. Histologically it appears as a uniform layer. However, recent histochemical methods show that it may consist of upto four definitive layers, an outer thin cement layer, a wax layer, a polyphenol layer and an inner cuticulin layer. All these four layers, however, may not be present in all the insects.

The present work was carried out on *Attacus ricini* (Lepidoptera). The histochemical tests described below were performed to determine the nature of the epicuticle. For histological investigations serial sections were taken from the time the larvæ hatched out of the egg. The sections were stained in Heidenhain's Azan, Mayer's Hæmalum and Eosin. Azan gave the best possible results. The larvæ were reared at 30° C. and 100% R.H.

#### HISTOCHEMICAL TESTS

The method followed was mainly devised by Wigglesworth (1948). The different processes in succession were: (a) killing the larvæ in ammonia vapour, (b) treating the larvæ for 1 hr. in cold chloroform, (c) boiling the larva in chloroform for 1 hr., and (d) immersing the larva treated under (b) and (c) in ammoniacal silver nitrate solution. A control test was run.

To determine the presence of cuticulin layer the tergum was boiled in 10% potassium hydroxide solution to dissolve the endocuticle and polyphenol layers.

#### RESULTS OF HISTOCHEMICAL TESTS

Larvæ, whether treated in cold or boiling chloroform, gave Argentaffin reaction on treatment with ammoniacal silver nitrate solution. This clearly showed that the outermost cement layer is absent. The darkening is due to the presence of a polyphenol layer. The control test larva failed to show any darkening of the surface. We can thus infer from it that the outermost layer of the epicuticle is the wax layer. The caustic potash test showed the presence of cuticulin layer as the innermost layer of the epicuticle. Thus the epicuticle of the second instar larva of *Attacus ricini* is composed of the wax layer, the polyphenol layer and the cuticulin layer. The cement layer is absent.

#### RESULTS OF HISTOLOGICAL OBSERVATIONS

The epidermis separated from the first instar larval cuticle on the seventh day showed in the intervening period intense activity which was characterised by the epidermis becoming elongated and granular (Text-Fig. 1). At this stage

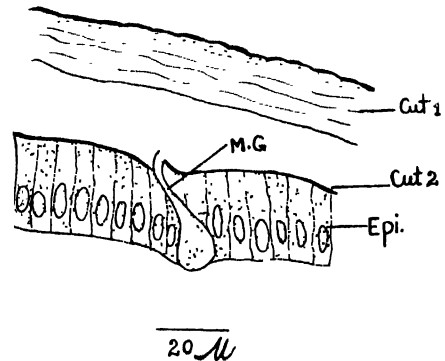

TEXT-FIG. 1. Camera lucida drawing of the epidermis on seventh day stage.

Cut. 1. Cuticle of the first instar; Cut. 2. Cuticle of the second instar; Epi. Epidermis, M.G. Moulting gland

moulting glands were observed. Multicellular trichogen cells and œnocytes were also observed at places. Besides these, pore canals were observed extending upto the epicuticle. On the ninth day most of the endocuticle of the larval cuticle was found to have been digested and the moulting of the first larval cuticle took place. By this time the second larval cuticle was not completely formed. By the eleventh day the second cuticle attained its maximum size and on the twelfth day the condition was similar to the eleventh day stage. On the thirteenth day the epidermis separated from the second instar cuticle and a new cuticle was deposited in its place. The second instar larval cuticle has an exocuticle which appears dark brown with Azan, the endocuticle, on the other hand, appears blue with this stain.

Further investigation is in progress and a detailed paper is expected to be published shortly by us.

Dept. of Zoology,  
Science College,  
Patna, March 14, 1958.

R. K. SHARAN.  
S. L. SAHNI.

1. Wigglesworth, V. B., *Q.J.M.S.*, 1948, **89**, 197.
2. —, *Proc. Roy. Soc.*, 1947, **134 B**, 163.
3. Wolfe, L. S., *Q.J.M.S.*, 1954, **95**, 67.
4. —, *Ibid.*, 1955, **96**, 181.

**OCCURRENCE OF ANCHOVIELLA  
INSULARIS HARDENBERG OFF  
WALTAIR COAST**

HARDENBERG<sup>1</sup> first reported *Stolephorus (Anchoviella) insularis* from the Indonesian waters. His identification is based on vertebral counts, the length at which maturity is first reached, and on investigations of planktonic eggs by Delsman.<sup>2</sup> Later, Fowler<sup>3</sup> described the same species as *A. bataviensis*. Hardenberg divided the species into four subspecies based on vertebral counts and other external characters.

In our studies on *Anchoviella* spp. of the Waltair coast, we have come across, in addition to *A. heterolobus*, *A. indica* and *A. commersonii*, a large number of forms which fit into the description of *A. insularis* given by Hardenberg and Fowler.

The following are the characters of the species under study:

1. There are three main groups with regard to the number of vertebræ. Of the 416 specimens examined from 10 samples, the distribution was as follows:

No. of vertebræ	No. of specimens
38	19
39	180
40	65
41	148
42	4

Our observations show that the two small groups with 38 and 42 vertebræ occur especially when the forms with 39 and 41 vertebræ are predominant in the catches, and hence are to be included among them respectively.

*A. commersonii*

- Two pigment lines on the back from head to dorsal fin.
- No dense pigmentation on the upper half of eye.
- The mean of the number of rays in the left pectoral fin is 14.24.
- The number of gill rakers ranges from 22-24.
- Anal fin starts below about the posterior  $\frac{1}{3}$  of dorsal fin.
- The ovarian eggs are shorter and wider with a prominent knob.

*A. tri*

- Presence of pigment lines from head to caudal fin.
- The oval eggs are not knobbed.
- The anal fin starts below posterior  $\frac{1}{4}$  of dorsal fin.
- The number of vertebræ is 38.<sup>1</sup>

2. A count of rays in the left pectoral fin of 331 specimens gave the following results:—

No. of Pectoral fin rays	No. of specimens
11	27
12	110
13	140
14	52
15	2

3. An examination of 261 specimens for the number of gill rakers on the longer arm of the first gill arch of the left side, shows the distribution as follows:

No. of gill rakers	No. of specimens
19	34
20	89
21	85
22	45
23	8

4. The ovarian eggs are oval with a knob at one end, resembling those of *Stolephorus (Anchoviella) insularis*, described by Delsman.<sup>2</sup>

5. Dense pigmentation on the head and upper half of eyes, especially in the larger forms, but without any definite pigment lines on the back.

The only other species of *Anchoviella* which could be confused with *A. insularis* are *A. commersonii* and *A. tri*. But the characters of the species obtained by us do not agree with those of the latter two species as given by Hardenberg<sup>1</sup> and by Nair.<sup>4</sup>

1. Characters in which *A. insularis* differs from *A. commersonii*:

*A. insularis*

- Absence of these pigment lines.  
Dense pigmentation on the upper half of eye.  
The mean of number of rays in the left pectoral fin is 12.67.  
The number of gill rakers ranges from 19-23.  
The anal fin starts below the middle of dorsal fin.  
The ovarian eggs are longer and narrower with a less prominent knob.

*A. insularis*

- Absence of these pigment lines.  
The oval eggs are knobbed.  
The anal fin starts approximately below half the dorsal.  
The number of vertebræ is more than 38.



This is the first report of the occurrence of this species in Indian waters. Present data indicate the presence of at least two subspecies. Further work is in progress, and details will be published elsewhere.

Dept. of Zoology,  
Andhra University,  
Waltair, February 14, 1958.

S. DUTT.  
M. BABU RAO.

1. Hardenberg, J. D. F., *Treubia*, 1932-34, 14.
2. Delsman, H. C., *Ibid.*, 1931, 13.
3. Fowler, H. W., *U.S. Nat. Mus. Bull.*, 1941, 13, 100.
4. Nair, R. V., *Jour. Zool. Sec. India*, 1953, 5 (1).

#### NOTE ON THE PROTEINS FROM THE SEEDS OF *SESBANIA GRANDIFLORA*

THIS note deals with protein adhesives made from the seeds of *Sesbania grandiflora* which have been reported rich in proteins (Subrahmanyam *et al.*, 1952).

The seeds, obtained from the Director of Agriculture, Madras, had the following proximate composition: moisture 6.5%, nitrogen 6.9%, fat 7.6% and ash 4.3%. Extraction with various solvents resulted in the following percentages of the total nitrogen being removed:

(Narayanamurti and Kartar Singh, 1942). Ply-wood made with such glues gave, on testing, the following results (Table I).

The defatted flour when used as a filler in casein glues (2:3) using the lime fluoride formula (Narayanamurti *et al.*, 1943) gave the following results.

TABLE II

Glue adhesion			
Dry		Hot wet 70° C.	
F.L. Kg.	G.F. %	F.L. Kg.	G.F.
100.24	40	43.54	100

Forest Research Inst.,  
Dehra Dun,  
March 26, 1958.

D. NARAYANAMURTI.  
R. C. KOHLI.

1. Narayanamurti, D. and Kartar Singh, *Ind. For. Leaflet*, 1942, No. 15.
2. Narayanamurti, D., *et al.*, *For. Bulletin*, 1943, No. 116.
3. Subrahmanyam, V., *et al.*, *Curr. Sci.*, 1952.

TABLE I

Glue Adhesion strength								
Formaldehyde				Furfural				
Dry		Hot wet 100° C.		Dry		Hot wet 100° C.		
F.L. <sup>+</sup> Kg.	G.F.* %	F.L. Kg.	G.F. %	F.L. Kg.	G.F. %	F.L. Kg.	G.F. %	
Protein from whole meal	.. 127.00	50	79.83	100	128.82	80	53.54	100
Protein from defatted meal	.. 81.64	100	48.99	100	128.82	70	61.69	100

+ F.L. = Failing load.

\* G.F. = Glue failure.

water 46.9, 4.0% sodium chloride solution. 55.4, 80% alcohol 9.0, 0.4% sodium hydroxide 82.6 and 0.4% sodium sulphite 78.0.

For the preparation of the protein, 20 g. of the defatted meal were extracted thrice with sodium sulphite, centrifuged and the protein precipitated from the clear extract with acetic acid. The yield was 32% with sodium sulphite and slightly higher at 35% with sodium hydroxide. The defatted protein gave: moisture 7.2%, nitrogen 13.85% and ash 7.6%. Washing reduced the ash content to 3.2%.

Adhesives were made from this protein using borax formaldehyde or furfural formulations.

#### A CHEMICAL EXAMINATION OF *EMBLICA OFFICINALIS*, GAERTN

The fruit of *Emblca officinalis*, Gaertn, formerly *Phyllanthus emblica*, Willd (*Hindi and Bengali*: Amla, *Malayalam and Tamil*: Nellikai) is one of the most used and reputed drugs in indigenous Indian medicine. It is refrigerant, diuretic, laxative, alterative, rejuvenant and good for diabetes.<sup>1,2</sup>

It is one of the richest and cheapest sources for vitamin C, the quantity of which does not appreciably diminish when stored dry.<sup>3-6</sup> Recently Dhar *et al.*<sup>7</sup> made a paper chromatographic study of its extracts.

## RESULTS OBTAINED

The dry powdered pericarp of *Amla* contains fatty matter (about 6%), gallic acid (5%), a new crystalline acid phyllemblic acid,  $C_{16}H_{28}O_{17}$  (COOH)<sub>8</sub>, m.p. 222-24° C. (6.3%), a new crystalline phenolic product, emblicol,  $C_{20}H_{30}O_{19}$  (OCH<sub>3</sub>)<sub>6</sub>, m.p. 191-94° C., ellagic acid and other products. Some appear to be products of hydrolytic fission as the juice of the fresh fruit contains much less gallic acid.

## MEANS AND METHODS

The pericarp was first dried in the sun and then at 50° C. and 100 mm. pressure. Only two out of several methods tried are described in this paper.

*Extraction I.*—The powdered pericarp (100 g.) was extracted with water (1½ litres), pressed in a linen bag, filtered and the brown filtrate (900 ml.) extracted for 18 hr. with ether in a liquid-liquid extractor. The crystalline ethereal residue (5 g.) on purification gave gallic acid, m.p. 250-53° C., identified by analysis and mixed melting point.

*A New Acid Phyllemblic Acid (6.3%).*—After extraction with water the press-cake was extracted with caustic soda to pH 8 (2%, 350 ml.), the slimy product pressed through linen and centrifuged. The clear brown liquid (342 ml.) was acidified (HCl, 20% to Congo-red), cooled, filtered, the residue washed and dried; (micro-crystalline powder, 6.3 g.), m.p. 219-22° C. This new acid was insoluble in all common solvents and was purified by repeated crystallisation of the ammonium salt from aqueous ammonia (charcoal), or by treatment with a solution of sodium bicarbonate, when the acid dissolves and the sparingly soluble sodium salt crystallises out, the acid being regained by acidification. Two such treatments gave a pure ash-free product, white rectangular plates, m.p. 222-24° C. There was no loss in weight when dried at 110° C. *in vacuo* over P<sub>2</sub>O<sub>5</sub>. It gave no coloration with ferric chloride. Found: C, 33.78, 34.25; H, 4.58, 5.19%; Eq. wt. 106.9 (NaOH), 105.55 (Ag salt).  $C_{16}H_{28}O_{17}$  (COOH)<sub>8</sub> requires: C, 33.80; H, 4.23; minimum mol. wt. 852, i.e., (106.5 × 8).

Phyllemblic acid has first the sour-bitter and then the sweet astringent taste associated with *Amla*.

*Extraction II.*—The powdered pericarp (1,828 g.) was Soxhleted, first with dry ether for 20 hr. (150 g. fatty and other matter) and then with (frequent changes of) methanol for four months. Thick brown easily soluble products were obtained in the first three days,

after which almost insoluble solids (A) began to separate. The solids A (68.9 g., 3.8%) were filtered off, concentration of the mother liquors gave soluble crystalline material B (125 g., 6.8%), softening from 170° C. and melting before 184° C.

*Insoluble Product A.*—The insoluble product A (0.8 g., ash 9%) was subjected to chromatography by the method of 'divided columns'.<sup>8</sup> Mercks alumina (40 g., 45 cm. high) was used, the substance was eluted with pure methanol, then with methanol containing 1% acetic acid, and later with methanol containing 1% HCl. Twenty fractions (50 ml. each) were collected. The second eluant gave a microcrystalline powder which does not melt up to 400° C. and the third eluant gave pale yellow crystals of ellagic acid (0.1 g.).

*Emblicol, a Phenolic Substance (Ca 4.5%).*—The soluble solids B gave by repeated crystallisation from methanol, a more soluble phenolic acid and a less soluble phenol, emblicol, crystallisable from methanol or ethanol, thin rectangular plates, m.p. 191-94° C. It is insoluble in ether and benzene, fairly soluble in water and the simple alcohols, does not give carboxylic reactions and gives a faint blue colour with ferric chloride.

Found: C, 40.78; H, 6.22; (OCH<sub>3</sub>) 23.7, 25.3%.  $C_{20}H_{30}O_{19}$  (OCH<sub>3</sub>)<sub>6</sub> requires: C, 41.06; H, 6.32; (OCH<sub>3</sub>)<sub>6</sub>, 24.47%.

Emblicol has the lingering sweet astringent taste of the drug.

## ACKNOWLEDGEMENT

The analyses were kindly carried out in the National Chemical Laboratories, Poona. One of us (K. M. I.) thanks the Government of India for a Senior Research Scholarship.

Applied Chemistry Dept., P. P. PILLAY.

University of Kerala, K. MAHADEVA IYER.

February 21, 1958.

1. Nadkarni, A. K., *Indian Materia Medica*, 1, 3rd Edition, p. 481.
2. —. *Ibid.*, 2, p. 467.
3. Damodaran, M. and Srinivasan, M., *Curr. Sci.*, 1935, 3, 553.
4. — and Nair, K. R., *Biochem. J.*, 1936, 30, 1014.
5. Giri, K. V. and Doctor, N. S., *Ind. J. Med. Res.*, 1938, 26, 165.
6. Giri, K. V., *Ibid.*, 1939, 27, 429.
7. Dhar, D. C., Shrivatsava, D. L. and Sreerivasaya, M., *J. Sci. Ind. Res. (Delhi)*, 1956, 15C, 205.
8. Pillay, P. P., Rao, D. S., Nair, C. P. N. and Varkey, E. T., *J. Chem. Ind.*, London, 1958, No. 9, 258.

### CYTOPLASMIC MALE STERILITY IN PSYLLIUM (*PLANTAGO OVATA* FORSK.)

CYTOPLASMIC male sterility has been reported<sup>1</sup> in flax, onions, carrots, sugar beets, corn, and sorghum, and a few other plants used mainly for genetic investigation, such as *Epilobium* and *Oenothera*. Very little is known about the occurrence of cytoplasmic male sterility in the lesser important economic crops and non-commercial plants. This type of male sterility is a valuable tool in the hands of plant breeders and hybrid seed producers, since a normal plant can be made male sterile by crossing with the cytoplasmically male sterile plants as the recurrent female parent.

*Plantago ovata* Forsk. is the source of Psyllium or Isabgol seeds and is cultivated extensively in northern parts of Bombay State and is a major article of export to the United States.<sup>2</sup> During the course of a study of the mucilaginous seeds it was found that a fair proportion of the plants of *P. ovata*, both under cultivation and in the wild state, showed a male sterile condition. Such plants could be readily differentiated from the normal plants by the shrivelled appearance of their anthers as compared to the membranous, well developed anthers of the normal plants. On microscopical examination, the shrivelled anthers were found to contain no pollen grains in the pollen sacs. However, no difference in the seed setting quality of both normal and male sterile plants could be observed, both being freely wind-pollinated and perfectly female fertile.

In order to determine the type of male sterility the seeds were collected separately from six normal and six male sterile plants. Their progeny was followed for three generations and the results are discussed below.

1. All normal plants, whether selfed or cross-pollinated, gave normal plants at each successive generation. The only exception was the occurrence of a few partially sterile plants when grown under greenhouse conditions. Jones and Mangelsdorf<sup>3</sup> observed a similar appearance of male sterility in normal corn plants grown in the greenhouse and attributed it to the effect of a higher temperature at the seedling stage.

2. All male sterile plants used as female parent when crossed with male fertile plants gave male sterile plants. This purely maternal transference of male sterility appears, therefore, to be due to the effect of the cytoplasm. From the limited number of normal plants used in this study, there appeared to be no evidence of any fertility restorer genes.

It is of interest to mention here that male sterility has also been observed by the writer in the common weed, *Pantago lanceolata* L., growing at several different localities. No attempts have, however, been made to determine the type of sterility in this case. Further work is in progress.

My sincere thanks are due to Prof. P. N. Mehra for helpful suggestions.

Dept. of Pharmacognosy,  
Panjab University,  
Amritsar, March 14, 1958.

C. K. ATAL.

1. Edwardson, J. R., *Bot. Rev.*, 1956, **22**, 696.

2. Shirname, T. G., *Marketing of Isabgol (Paylum Seed) in India*. Govt. of India, Ministry of Agriculture, New Delhi, 1949.

3. Jones, D. F. and Mangelsdorf, P. C., *The Connecticut Agriculture Experiment Station Bull.*, 1951, 550, New Haven.

### MICROTRON

**A** MACHINE of novel type for the acceleration of electrons to high energies has been completed and brought into use at University College, London, by Dr. Aitken and Dr. R. E. Jennings. It overcomes in an unusual way a difficulty in design caused by the increase in mass of the electrons as the speed of light is approached.

The trick used in the University College machine is to arrange that the extra energy given to the electrons at each circuit is such that their mass is increased in steps, each equal to the mass of an electron when at rest. Under these conditions the times taken in successive circuits increase progressively, but are in all cases an exact multiple of the time taken for

the first circuit. The electrical pulse that provide acceleration can therefore be applied at regular intervals and, although some pulses will be missed, there will always be a pulse when it is wanted.

The principle of this type of accelerator was originated by three Canadians—Dr. J. T. Henderson, P. A. Redhead, and H. Le Caine—working for the Canadian National Research Council. It is called the "Microtron" because the electrical pulses used in acceleration are got from a pulsed microwave oscillator.

The University College machine accelerates electrons to an energy of 29 million electron volts and is the largest yet built.

---

---

## REVIEWS

---

---

**Fundamental Constants of Physics.** By E. R. Cohen, K. M. Crowe and J. W. M. Dumond. (*Interscience Monographs*. Vol. I), 1957. Pp. xi + 287. Price \$7.50.

The last twenty-five years have contributed greatly to the improvement of our knowledge of the constants of physics, through the use of new precision techniques and methods of measurements, combined with advances in our understanding of atomic and nuclear physics. This book is a competent survey of this development in our knowledge of the fundamental constants and conversion factors of the physical sciences. Most of the earlier and less precise experiments have been reviewed rather briefly, one of the authors' objective being, "to present an account of the evolution of our knowledge of this subject through various degrees of experimental precision and theoretical sophistication in sufficient detail to permit the reader to appreciate the breadth and firmness of the entire experimental foundation". This objective has been substantially achieved.

After one introductory chapter, there is one chapter devoted to arbitrarily defined physical units and standards like those of length, mass, volume, time, temperature and electrical units and another chapter devoted to classical measured constants and units like universal gravitation constant, gas constant, Joule equivalent, etc. Coming to recent developments, there is one chapter on masses of atoms and mesons, masses and properties of light mesons, K-mesons and of hyperons. One wonders, at this stage, why experiments on the properties of other fundamental particles like the positron and the neutrino have not been included in the subject-matter of the book. One chapter deals with the history of atomic constants like velocity of light, electronic charge  $e$ , the X-unit, Avogadro's number and Planck's constant. Another chapter describes the post-war high-precision measurements of constants like gyromagnetic ratio of the proton, ratio of electron magnetic moment to proton magnetic moment and hyperfine structure shift in hydrogen. There are two very useful chapters on the method of least squares and its application in the determination of atomic constants.

The book is undoubtedly a very helpful re-

ference work for physics students and for teachers and research workers in physics.

B. V. THOSAR.

**High Energy Nuclear Physics.** (*Proceedings of the Seventh Annual Rochester Conference*, April 15-19, 1957.) Compiled and edited by G. Ascoli, G. Feldman, L. J. Koester, Jr., R. Newton, W. Riesenfeld, M. Ross, R. G. Sachs. Distributed by Interscience Publishers, Inc., 250, Fifth Avenue, New York City Pp. ix + 473. Price \$4.50.

This volume is a report of the Proceedings of the Seventh Annual Conference on High Energy Nuclear Physics that was held at the University of Rochester on April 15-19, 1957. The purpose of the Annual Rochester Conference, to quote from the Foreword of the book, "is to bring together a representative group of active workers from high energy physics laboratories throughout the world for an informal complete discussion of the experimental and theoretical developments of the previous year". That this object has been fulfilled admirably is apparent even from a casual look at the contents of the papers submitted during the Conference and from the names of the participants who represent the most active workers in the subject at the present moment.

The Conference was divided into eleven sessions, each devoted to discussion on a special aspect of nuclear physics. The report of each session starts with an introductory survey by a moving speaker and is followed by the presentation of papers by other workers in the field, with discussions interspersed between them which are both informal as well as highly technical. The opening session bears the title, "Structure of Nucleons" and in it we find a survey of the two regions into which it has now become customary to divide the nucleus, namely the outer part where the  $\pi$  mesons predominate and for which the Yukawa picture gives a good basis, and the "inner core" where, it is believed that our present notions of space and time break down.

Session II (or Chapter II) deals with pion reactions. The third session devoted to "Nucleon-nucleon interaction" contains an interesting account of the nature of nuclear

potentials and a number of papers on the scattering of nucleons by nucleons and polarization experiments. In his introductory survey, Professor Marshak shows that a potential which is a mixture of central, tensor and spin orbit forces gives a good fit of the experimental data on two nucleon interaction upto an energy range of 150 Mev.

The most spectacular development in elementary particle physics during the last year is the fall of the conservation law of parity, and the Proceedings of the Session entitled, "Weak Interactions" with C. N. Yang as the Chairman and Professor Lee as the moving speaker should therefore prove to be particularly pleasing and interesting. In this chapter we have a review of the two component theory of neutrino and the conservation laws of physics in general, and surveys on the classical experiments like the beta decay of polarized  $\text{Co}^{60}$  nuclei, which demonstrated conclusively the non-conservation of parity in weak interactions.

Another important development of recent years relates to the discovery of anti-proton and the chapter entitled "Antibaryon Phenomena" gives an account of the production of these particles, the nature of their interactions and experiments relating to their scattering cross-section. Besides, the volume contains reports of several sessions on strange particles and their interactions, and a chapter in theoretical physics in which is presented amongst other papers a review by Schwinger on the structure of Green's functions.

The volume records every remark made by the participants of the Conference and this conversational style gives one the feeling of living through the Conference. The book will undoubtedly be welcome to all workers in field theories and to experimental physicists working in nuclear or cosmic ray physics.

K. S. V.

**Safety Techniques for Radioactive Tracers.** By J. C. Bournell. (Cambridge University Press), 1958. Pp. xi + 68. Price 7 sh. 6 d.

With the increasing application of tracer techniques in the field of experimental biology, medicine and chemistry, a handy publication, dealing with safety and precautionary measures to be followed in handling radioactive isotopes, is a welcome one and the book under review is such a publication that has been brought out by the Cambridge University Press.

A hot laboratory is a place where an active consignment is dealt with and disposed off for

subsequent use, in a cold laboratory, and therefore the contamination and health hazard is more serious in the former than in the latter. A very brief summary of the types of radiations and their harmful effects, and the routine precautions such as wearing film badges and the periodic blood check-ups are set out in the earlier part. Under contamination and cleanliness, very useful tips, and methods to be followed in the 'hot' as well as 'cold' laboratories are fully dealt with, including a small section on disposal of waste.

The most useful part of the book is to be found at the end where summary of recommendations, maximum permissible levels for contamination in laboratory handling, classification of radioactive isotopes by toxicity, a few laboratory ware and dose levels are set out in a highly condensed form. A bibliography is also appended at the end where references to other publications and original papers dealing with the subject of tracer methods and radiation hazards are presented. This book should be possessed and carried by all workers who are dealing with radioactive material.

**The Measurement of Colour.** Second Edition. By W. D. Wright. (Hilger & Watts, Ltd., London), 1958. Pp. ix + 263. Price 52 sh.

As one of the earliest authoritative treatises on the principles, methods and applications of the trichromatic system of colour measurement, the first edition of this book has occupied a very well-defined place on the bookshelf of every serious student of optics. The present volume is, accordingly, a timely revision of what has long been considered a standard text-book on this subject.

The opening chapters of the book are of an introductory nature and deal with radiation in the visible spectrum—its emission, absorption and reflection, and its reception by the eye. They are followed by what is virtually the core of the book, which has now been rewritten in the form of two chapters. The first deals with the principles of photometry and the theoretical and experimental basis of trichromatic colorimetry, while the second deals in more detail with the C.I.E. system of colour measurement. This chapter includes sections on the definition of the standard observer and the standard reference stimuli, as well as a description of the procedure followed in computing tristimulus co-ordinates from spectrophotometric data. Reference is also made to the specification of colours in terms of dominant

wavelength and purity, a system which has advantages for some applications.

The next two chapters are devoted to descriptions of some of the better known types of colorimeters and spectrophotometers, and a discussion of the problems of subjective judgments of colour differences and the construction of a suitable atlas of colours. The Munsell system, in particular, is dealt with in some detail. This is followed by a new chapter dealing with the application of colour mixture data to three colour reproduction, with particular reference to colour television and colour photography. This appears an opportune addition, in view of the attention which is now being bestowed on these subjects.

The concluding chapter of the book is an outline of some of the applications of colour measurements. It includes sections on the analysis of interference and polarization colours, the apparent colours of objects seen at great distances and the phenomenon of dichroism, as well as on the use of colour measurements in such obvious fields as the quality control of signal glasses, paints and dyes, and in some other, not so obvious, fields as agriculture, food packing and the paper industry.

The general standard of production of this volume is quite high and it is profusely illustrated. Other features are comprehensive references, a full index and four appendices which include several useful tables. With the increasing use of the trichromatic system of colour measurement in science and industry, this volume is certain to prove an invaluable reference work to a large circle of readers.

P. HARIHARAN.

**Encyclopedia of Chemical Technology—First Supplement Volume.** Edited by Raymond E. Kirk and Donald F. Othmer, Assistant Editor: Anthony Standen. (Interscience Publishers, Inc. Agents in India: Asia Publishing House, Bombay-1), 1957. Pp. xviii + 974. Price \$ 25.00.

No less than fifteen volumes have appeared under the above title, comprising of a comprehensive summary of industrial knowledge on materials, methods, processes and equipment for the chemist and the chemical engineer, contributed by more than 1,000 experts. In an ever-expanding age of technology new materials, new methods, and new processes are continuously pouring in and the publisher is therefore faced with the problem of bringing such publications up to date.

The matter under review is the first supplement volume that has been got up by the publishers to include articles on subjects of wider interest, to add some more individual substances that have commercially become important in recent years and to discuss certain reactions and unit operations such as cyano-ethylation, fluidization, etc.

The application of servomechanism principles to chemical processing can result in automatic process control, while the application of operation research methods will result in optimum production scheduling. This combined application is called automation or systems of engineering. Under automation certain basic conceptions are discussed. Computers which are finding increased industrial applications in recent years are briefly treated.

Quite fittingly in this volume under nuclear reactors, a fairly detailed account of the several types of reactors currently in use and the engineering problems arising out of the specialised nature of reactor technology are presented. An article on solid state describes recent advances in this field such as semiconductivity, imperfections in solid state, sintering processes and solid state reactions all of which are greatly significant and are already beginning to bear fruit in improved chemical technology. Certain other subjects dealt with, *viz.*, photovoltaic solar converters, solar energy, water demineralisation are of immense interest and promise great future possibilities.

The fifty-one articles appearing in this supplement volume are arranged alphabetically and contain cross-references to the original volumes as well as to this volume. The volume is beautifully got up in art paper as its predecessors and bears the stamp of top-class production.

It is highly regrettable to hear that Dr. Kirk, the Senior Editor, passed away in February 1957, who until shortly before his last illness was concerning himself with this volume. The sixteen volumes are a tribute to his genius as the editor, which capacity he shared with D. F. Othmer.

A. J.

**Carnegie Institution of Washington, 1956-57.**

The Year-Book under review presents the excellent work turned out by the chain of laboratories of Carnegie Institution of Washington, during the year 1956-57. Research in these laboratories is mainly carried out in branches like Radio Astronomy, Terrestrial Magnetism,

Geophysics, Plant Biology, Embryology, Genetics and Archæology. Diversity of approach is the very life-blood of the scientific effort. Carnegie Institution rightly enlists men of most unlike temperaments and talents. These, and many other circumstances and the fact that the whole of the Institution's work is pointed towards the end of uncommitted research, fit it peculiarly to assist in the major task of scientific synthesis.

The Institution has been keeping in pace with the rapid advances made in science. Analysis of fine structure of solar radio emission, study of Jupiter as a source of radio noise, to obtain a detailed knowledge of the nature of radio sources, and the actual construction of a radio telescope to be equipped with a 60-foot dish, have been some of the interesting programmes undertaken by Mount Wilson and Palomar Observatories and in the Department of Terrestrial Magnetism. The problem of the determination of the age of the rocks has engaged the attention of several earth scientists since last few years. In the geophysical laboratories of the Institution, particular emphasis has been given to the means made available by the natural radioactive decay of potassium to argon; and of rubidium to strontium. A striking specific finding in the past year in this area of research has been the establishment; by concordant rubidium-strontium and potassium-argon datings, of an age of about 340 million years for the micas in a number of granitic rocks. Phase equilibrium relations among the major rock-forming mineral groups, study of the kinds of patterns that might be obtained in various types of order-disorder in crystals, methods of absolute counting of  $\beta$  radioactivity continue to be some of the major investigations in the geophysical laboratory.

The Carnegie Institution is further interested in fundamentals of biology. Synthesis of amino acids from simpler components under conditions simulating those believed to have obtained on the earth in the remote geological periods has been their pioneering work. Perhaps the most dramatic findings of the biophysics group for the year has been the demonstration that under appropriate conditions rather large particles containing nucleic acids, proteins and lipids can be made to form 'spontaneously' from disintegrated cellular material. The Department of Plant Biology has long maintained a central concern with the nature of the photosynthetic pigment chlorophyll as it occurs in the living plant. Laboratory analysis and studies of the Department of Archæology

have revealed significant facts of the Maya culture.

The creation of an environment to conduct researches in fundamental sciences is the task to which the Carnegie Institution is dedicated; and for which it is unusually equipped. The Institution has already accomplished much in the direction of progress of science, and its task in the future will be yet greater.

S. BALAKRISHNA.

---

**Antibiotic Annual, 1957-58.** Edited by Henry Welsh and Felix Marti-Ibanez. (Medical Encyclopedia, Inc., New York, N.Y.) (Distributors outside U.S.A.: Interscience Publishers, Inc., New York; India: Asia Publishing House, Bombay), 1958. Pp. xvii + 1070. Price \$12.00.

The Antibiotic Symposium in Washington has become an annual feature and the present volume is a record of the Fifth Symposium held on October 2, '3 and 4, 1957. It represents what the people assembled there "have thought, and done and what they contemplate doing further in the antibiotic field"—in short, the way in which the wind blows in this extensive field of antibiotic medicine. There are 161 papers besides 3 panel discussions, a large percentage of which emanating from the U.S.A. The studies presented relate to novobiocin, vancomycin, amphotericin B, tetracycline phosphate, antibiotic combinations (with oleandomycin being the interested partner), use of penicillinase for treatment of toxic reactions due to penicillin, a national survey of toxic reactions due to antibiotics (this article being since reproduced in *Antibiotic Medicine*), use of gamma globulin with antibiotics, etc. The new antibiotics reported are: ristocetin, quinocycline complex, telomycin, pimarin, sulfocidin and three antifungus polyene antibiotics. The Randall Lecture of Dr. Jawetz is on "Patient, Doctor, Drug and Bug" the "four main participants in the daily drama" involving infectious diseases and their treatment. In this, we learn that our flesh is heir to 2,936 reported illnesses and complaints and that antibiotic administration was warranted for less than half of these. The reviewer agrees with and underlines the conclusion that "all conceivably available fixed contractions of antibiotics, whatever their claims and purported benefits, have far more disadvantages than merits". Some papers in this volume also will bear this out. There are reports on three panel discussions on "Rheumatic fever prophylaxis", "Host resistance and

chemotherapy" and "Antibiotics as antitumour and antiviral substances". We have yet to discover antibiotics of definite value against the virus infections and cancer. The tremendous amount of work going on in this direction could be realized from the fact that the screening programme costing 3 to 3.5 million dollars and involving about 2 million mice, evaluates 30,000 beers per year. It is reported that about 10% of these show some activity. We hope something will come out of this colossal programme of work. Antibiotic research seems to be a never-ending affair. As Marti-Ibanez says, "our problem is to develop fresh weapons for combating diseases in general and infectious diseases in particular. This is a scientific problem. We want also to render these weapons into instruments that will help us to understand the actual history of a disease and the biological cycle of its causal germs. This is a historical problem for it affects the knowledge and advance of our time". We have to do quite a lot of work to do justice to this great programme of work.

K. GANAPATHI.

*The Invertebrata*. Third Edition. By L. A. Borradaile, F. A. Potts, L. E. S. Estham and J. T. Saunders. Revised by Dr. G. A. Kerkut. (Cambridge University Press), 1958. Pp. vii + 795. Price 55 sh. net.

We welcome the third edition of *The Invertebrata*, revised by Dr. Kerkut, a text-book which has been holding sway for over a quarter century. Undoubtedly the book under review is a comprehensive treatise, bringing under its purview an organized account of an array on invertebrate phyla. Aimed at providing an advanced account of anatomy and physiology of invertebrate animals at the University level, the book naturally does not deal in detail with the types described in elementary text-books.

Certain innovations have been resorted to. The acoelomate group comprehends phyla like Nemertea, Nematoda, Nematomorpha, Acanthocephala, Rotifera, Gastrotricha, Kinorhyncha, Priapulida and Endoprocta. Ectoproct polyzoa are treated under minor coelomata along with Brachiopoda, Chaetognatha and Phoronidea. The Protochordata include the Graptolita as these appear to show greater affinities with them. Onychophora and Trilobita are treated together as classes in Chapter X. There is a chapter added in this edition; it deals with relevant literature to which the student is initiated, should he desire additional information. A

few of the more important scientific journals are also listed.

We are sure that the new edition of *The Invertebrata* with some chapters rewritten (Insecta) or expanded so as to include recent findings in the various invertebrate phyla will be as popular as before. As the book is a mine of information, we have no hesitation in recommending the addition of the same to all zoological libraries. The college student cannot find a more useful and authoritative text-book than the one under review. We should, however, point out that for the Indian student, the book is priced rather high.

L. S. R.

*The Mulching of Vegetables*. By Patricia Rowe-Dutton. (Technical Communication No. 24, Commonwealth Bureau of Horticulture and Plantation Crops, East Malling, Kent), 1957. Pp. xiv + 169. Price \$2.80.

This is a sequel to an earlier publication of 1955 on effect of mulching on soil properties and stubble mulch farming. The range of mulching material discussed in the book extends from natural substances such as plant residues, peat manure, stones, etc., to manufactured materials including asphalt, paper, glass wool, aluminium foil, bituminous emulsion and polyethylene plastic. In an introductory chapter the purposes and effects of mulching on moisture conservation, weed control, temperature regulation, winter protection, etc., are discussed. According to the author the publication lays stress as much as possible on practical aspects and on any general trends of horticultural significance that have emerged.

The following eleven chapters deal individually with various vegetable crops such as Asparagus, Brassicas, Cucurbits, Onions, Peas and Beans, Potatoes, Egg plant (Ehinja), Tomatoes, etc. The special feature of the book is that each chapter after discussing the results of mulching experiments finishes with a summary and the economics of mulching. Though the data discussed in the book mostly refer to experiments in centres where market gardening is very highly developed, there is useful information available to vegetable growers in underdeveloped countries of Asia, particularly those who deal with onion, potato and tomato. It may be mentioned in this connection that growing of onions with a rice straw mulch is an established practice in parts of the Philippines. Straw mulching is also extensively



practised by vegetable growers near about Bangkok in Thailand.

K. R.

**Looking at Chromosomes.** By John McLeish and Brian Snoad. (Macmillan & Co., Ltd., London), 1958. Pp. 88. Pl. 48. Price 16 sh.

This is a delightful pictographic account of chromosome behaviour during cell division and germ cell formation in *Lilium regale* intended to stimulate the interest of beginners in biology. Short crisp descriptions introduce the reader to the beautiful photographs illustrating the various stages.

In an objective presentation, the dogma: "All the cells of an individual contain identical complements of chromosomes and therefore of genes" (p. 3), should have been avoided. We warmly recommend the book to the novice in spite of its high cost.

M. K. SUBRAMANIAM.

#### Books Received

- Three Steps to Victory.** By Sir Robert Watson Watt. (Odhams Press, Asia Publishing House, Bombay-1), 1958. Pp. 480. Price 30 sh.
- Monographs on Mechanics and Applied Mathematics—An Introduction to Fourier Analysis and Generalised Functions.** By M. J. Light-hill. (Cambridge University Press, London N.W. 1), 1958. Pp. viii + 79. Price 17 sh. 6 d.
- Monographs on Physics—Mass Spectroscopy.** By H. E. Duckworth. (Cambridge University Press, London N.W. 1), 1958. Pp. xvi + 206. Price 35 sh.
- Microchemical Journal**, Vol. I, Issue 2. Edited by Nicholas D. Cheronis and others. (Interscience Publishers, New York), 1957. Pp. 167-324. Price \$ 9.60 per year.
- Memoirs of the Indian Animal Types. I. Dasyatis.** (The String Ray.) By Mary Chandy. (Maxwell Company, 66, Gautam Budh Marg, Lucknow), 1958. Pp. vi + 123. Price Rs. 5.

---



---

## SCIENCE NOTES AND NEWS

---



---

### How are Temperatures of Million Degrees Measured?

Obviously ordinary thermometers which depend on physical changes in material cannot be used. All substances vaporise at temperatures far below those needed for thermonuclear reactions.

The method used at Harwell and Aldermaston for measuring temperature is by means of a spectroscope. The basis of this method is, that it measures the speed of the nuclei which are contained in the hot gas.

It is possible to measure the speed of the atomic nuclei because they emit light of a definite frequency under high temperature. This light can be seen as a bright blue glow in the torus, and can be analysed by means of a spectroscope. The frequency of the light depends on the speed of the source, just as the frequency or pitch of the whistle of a passing train depends on its speed. This phenomenon, known as the Doppler effect, is made use of in the measurement of temperature.

In the case of the moving nuclei the result of the Doppler effect is to make light which would otherwise be of a single frequency, and which would therefore appear as a single line

on a photographic plate, spread over a range of frequencies and appear as a fuzzy line.

By measuring the width or 'fuzziness' of the lines on the photographic plate, a direct estimate of the temperature of the nuclei can be obtained.

### A New Spot Test for Nitrate Ion

The well-known diphenylamine and brucine tests for nitrate while sensitive, are lacking in specificity. Other oxidizing agents, such as chlorates and nitrites, give the same colour reaction as nitrate. In both tests the reagent is dissolved in concentrated sulphuric acid and this prevents their use for the detection of nitrate on substrates which might be charred by the strong acid, e.g., on paper chromatograms.

A new spot test for nitrate ion is described. The identification is based on the yellow-coloured product formed when diphenylamine and nitrate, spotted on filter-paper, are exposed to short-wave ultraviolet radiations. The yellow colour is probably due to products formed during the photochemical reaction. The reaction appears specific and relatively sensitive making it possible to detect 1 g. of  $\text{NO}_3^-$  in 0.01 ml. of solution.

### World Meteorological Organization to Study Tidal Waves

A worldwide study of tidal waves aimed at setting up an international warning system was agreed upon at the recent meeting in Geneva of the Executive Committee of the World Meteorological Organization.

Tidal waves are caused by underwater earth tremors, tropical storms and other geophysical phenomena, and often cause enormous destruction and loss of life in coastal areas. For this reason, the Committee considered that international investigations are necessary regarding the formation of tidal waves, and that results of research should be exchanged between all nations. This would eventually lead to the planning of an International Warning Service.

The International Union for Geodesy and Geophysics was invited to deal with oceanographical and seismological aspects of the problem.—UNESCO.

### X-Ray Image Intensifier

Image intensification presents two possibilities: (1) Greater brightness, the normal examination method being largely retained, but without any great dose reduction. (2) Greatest possible dose limitation, necessitating certain concessions as regards method of examination. The superiority of the image intensifier is manifested in fluoroscopy, especially in the case of great contrasts. Serial exposures are possible just as before. "Aimed" exposures in body areas that were formerly less accessible to X-ray examination (petrous bone, etc.) can easily be effected. Special apparatus for the resetting of fractures, heart catheterization and television are described.

Instead of direct observation, the fluorescent image can be photographed or filmed. For single exposures the procedure is of limited value. On the other hand, cineradiography has found great application, particularly in examinations of the digestive tract. A special image intensifier with an 11-inch (28 cm.) diameter screen has been developed for cineradiography of the entire heart.

The advantages of an X-ray cine-film lies in the possibility it offers of studying not only movement but also a very large number of individual images.

Cineradiography will win for itself a permanent place among routine methods of examination. It is not unlikely that the future will see the conventional fluorescent screen permanently replaced by the image intensifier.

The limitation of the X-ray dose received by both patient and operator will continue to be an urgent duty.

### Albomycin and Grisein

The first account of a new Russian antibiotic, albomycin, in the English language was a paper by G. F. Gause in *British Medical Journal*, 1955, 2, 1177. Very remarkable properties were claimed for this substance, including an activity against staphylococci ten times more powerful than that of penicillin.

These authors have shown that albomycin is closely related to, if not identical with grisein. Both are amorphous red substances containing iron and amino-acids, and both are separable into four active constituents. Their chemical and physical properties are as nearly indistinguishable as would be expected of two samples of the same substance having different degrees of purity: their antibacterial spectrum is the same, and organisms resistant to each are also resistant to the other. Grisein was discovered by Waksman and his colleagues eleven years ago.

### Pyrethrum

An age-old natural insecticide harmless to humans and animals is coming back in the news following the increase in resistance to synthetic insecticides and the recognition of possible hazards to public health of toxic residues left by the latter on foodstuffs. It is the daisy-like flower, Pyrethrum. Development of new compounds which have made Pyrethrum considerably more effective and yet cheaper, and the influence of the "Push-button aerosols" for which Pyrethrum is admirably suited, form the basis of the post-war story of this insecticide.

The widespread use of the synthetic insecticides on a scale never envisaged in pre-war days, focussed attention on the problem of toxic residues on foodstuffs constituting a menace to public health.

African Pyrethrum formulated with modern synergists, such as piperonyl butoxide, was found to be an ideal substance, as it is well known that Pyrethrum is rapidly destroyed in the human body and that it has no cumulative effect.

### Plant Growth Regulating Activity of IMSA

Although it was suggested as early as 1938 that an indole derivative, to be effective as a plant growth regulator, should possess a terminal carboxyl group in the side chain, or a

group readily convertible to a carboxyl group, it has become increasingly evident in recent years that some derivatives of indole which are effective as plant growth regulators do not meet this requirement.

3-Indolemethanesulfonic acid (IMSA) was found to be an active plant growth regulator in a wide variety of growth regulant assays. The compound induced leaf modification, stem curvature, and proliferation of intact tomato and bean seedlings, promoted growth of *Avena* first internode sections, induced curvature of slit pea sections, and suppressed the elongation of roots of cucumber seedlings. In preliminary weed control experiments, IMSA at 5 and 10 lb. per acre applied as a pre-emergence herbicide controlled both grass and broad-leaved weeds in broccoli, mustard, radish, and cabbage plantings with no injury to radish and slight injury to the remaining crops. Applied as a post-emergence herbicide, IMSA at 10 and 20 lb. per acre controlled broad-leaved and grass weeds in soyabean, corn and oat crops with no injury to oats, slight injury to corn, and severe damage to soyabeans. (Cont. Boyce Thomson Institute, Vol. 19, March 1958.)

#### Antibiotics in the Whaling Industry

A new chemical product was introduced into the whaling industry quite recently. Whaling men were shown how an antibiotic could be used to prevent decay and so save them the loss of a large part of their catch.

After the kill, carcasses are flaged and left floating in the water. For some of them, however, it may be several days before they reach land or a ship; and as a result, due to bacterial decay accelerated by the heat retained in the whale's body, anything up to half the value of the carcass may be lost.

Some while ago, in the far north of Norway, a demonstration was given of how to retard the progress of this decay and get the whales cut up before spoilage cost the whaling companies a large part of their profits. The carcasses were injected with a special whaling formulation of the antibiotic oxytetracycline ('Biostat') before being towed away. The preparation spread quickly from the point where it was injected through the whole of the whale's body. On arrival at the flensing station much of the carcass which would ordinarily have been lost through 'spoilage' was found to have been successfully preserved.

Preservation with an antibiotic can therefore be expected to play an important part in the future progress of the industry.

#### Salk's Contribution to Cancer Research

While looking for improved methods of producing his polio vaccine, Dr. J. E. Salk, of Pittsburgh, Pennsylvania, has made an important contribution to cancer research. He seems to be on the way to success in preparing a serum which will attack tumour cells.

The Salk polio vaccine is made by growing the virus in cells from monkey kidneys which are kept alive in special nutrients.

Salk's experiment consisted in injecting millions of the cancer-like cells into monkeys. In most cases nothing at all happened; but in some of the animals tumours started to grow and then disappeared again. The monkeys were able to fight the invading cells successfully.

As a rider to this experiment Salk tested the blood serum from these monkeys to see what effect it had on the proliferating cancer-like cells. It immediately killed them, but did not affect healthy kidney cells.

Here then is the basis for a cancer vaccine which will act specifically against cancer cells. Unfortunately, there is one snag which prevents the method being developed for treating humans. Unless the cancer cells are injected into the same animal (in this first case a monkey) as that from which they were originally obtained, the serum obtained kills both normal and cancer cells. But Dr. Salk indicates several possible solutions to the problem and there can be little doubt that an antiserum which acts only against certain cancer cells will be available in due course. (*The New Scientist*, Jan. 1958.)

#### Gibberellic Acid and Plant Growth

Gibberellic acid is a white crystalline solid of total formula  $C_{19}H_{32}O_6$ , and melting point 223-35°C. It is soluble in water to the extent of 5 g. per litre to give an aqueous solution of pH 3-4. It is stable when dry but unstable in aqueous and aqueous/alcoholic solutions.

One unique property of gibberellic acid, that of increasing the growth of plants by greatly elongating the cells, was first discovered by the Japanese pathologist, Kurosawa, in 1926.

Studying the symptoms of the *bakanæ* or 'foolish seedling' disease of rice Kurosawa observed that the casual pathogen was a soil-borne fungus, *Gibberella fujikuroi* which caused infected seedlings to grow very much taller than healthy ones. The culture filtrate when sprayed had the same effect. Other Japanese biologist showed that the filtrate would induce excessive growth in many other plants as well

as rice. These discoveries attracted very little attention until a few years ago it was taken up at the Akers Research Laboratories of Imperial Chemical Industries. The research workers at I.C.I. succeeded in preparing a highly active growth-promoting substance from a culture of *Gibberella fujikuroi*.

The biological activity of the chemical has been widely investigated in Japan, Great Britain and the United States. Studies are continuing in the United States, the United Kingdom and in many other countries on a very wide variety of crops. These studies are both fundamental and applied, and should lead to a much more complete understanding of the properties and possible uses of gibberellic acid.

#### Radio Isotopes Training Course

As a United Nations Regional Technical Assistance Project, a specialized training course in "Radio-isotopes" will be held in Tokyo (Japan) from 23rd August-19th September 1958. The UNESCO South-East Asia Science Co-operation Office in Djakarta and the Government of Japan are sharing responsibility for organizing this course. Governments of the region are being approached concerning their interest in participating in this training course.

#### International Congress of Industrial Chemistry

The Thirty-First International Congress of Industrial Chemistry will be held from September 7th to 20th, 1958, at LIEGE, an industrial city situated 100 km. from Brussels and possessing numerous and important installations of the Belgian Chemical Industry.

Organised with the collaboration of the *Federation des Industries Chimiques de Belgique* (Federation of Belgian Chemical Industries) this Congress will once again enable fertile contacts to be formed, or renewed, between those engaged in the scientific, technical, and industrial development of Applied Chemistry.

The following Groups and Sections have been formed: Group I: General Technical Problems of the Chemical Industry; Group II: Fuels; Group III: Nuclear Sciences; Group IV: Metallurgy; Group V: Industrial Chemistry of Minerals; Group VI: Cements, Building Materials, Glass-making; Group VII: Organic Che-

mical Industries; Group VIII: Food and Agricultural Industries; Group IX: Colonial Problems; Group X: Industrial and Social Organization.

Further information can be had from the General Secretarial Office, 32, rue Joseph II, Brussels IV (Belgium).

#### Award of Research Degrees

Andhra University has awarded the D.Sc. Degree in Zoology to the following candidates for their theses indicated against each: Shri R. Nagabhusana Rao, "Studies on Marine Wood-Boring Mollusca of Visakhapatnam Harbour"; Shri K. Hanumantha Rao, "Studies on Parasitic Worms of Fishes and Piscivorous Hosts from Andhra Pradesh"; D.Sc. Degree in Botany to Shri R. L. N. Sastry for his thesis entitled "Floral Morphology and Embryology of Some Ranales"; and the D.Sc. Degree in Chemistry to Shri S. K. Pavanaram for his thesis entitled "Synthesis of Furanobensopyrones and Chemical Examination of Indian Heart-Woods".

The Annamalai University has awarded the Ph.D. Degree in Chemistry to the following candidates for their theses indicated against each: Mr. T. S. Govindarajan, "Ultraviolet Absorption Spectra of Thiophenols and Aryl Sulphides"; Mr. K. M. Somasundaram, "Dielectric Contribution to Liquid Miscibility".

The University of Poona has awarded the Ph.D. Degree in Chemistry to the following candidates for their theses mentioned against each: Shri A. K. Das Gupta, "Diffusion and Evaporation of Trace Impurities from the Matrix of a Host Lattice"; Shri K. G. Gore, "Experiments in Benzopyrones"; Shri V. G. Naik, "Synthesis of Nitroflavonols".

#### Corrigendum

The note entitled, "The Effect of Certain Insecticides on Larvæ of *Anomis sabulifera* Guenther", published in the May 1958 issue (Vol. 27, No. 5, pp. 179-80) and the paper No. 2 under reference are actually the work of Dr. N. Dutt and Shri R. N. Ganguli, reported to the Indian Science Congress (*Proc. Ind. Sci. Congr. III*, 387, 1956).

The authorship should, therefore, be read as N. Dutt and R. N. Ganguli.

---

717-58. Printed at The Bangalore Press, Bangalore City, by C. Vasudeva Rao, Superintendent, and Published by A. V. Telang, M.A., for the Current Science Association, Bangalore.

All material intended for publication and books for review should be addressed to the Editor, *Current Science*, Raman Research Institute, Bangalore-6.

Business correspondence, remittances, subscriptions, advertisements, exchange journals, etc., should be addressed to the Manager, Current Science Association, Raman Research Institute, Bangalore-6.

#### ANNUAL SUBSCRIPTION

India: Rs. 8-00. Foreign: £ 0-16-0. \$ 2.50.

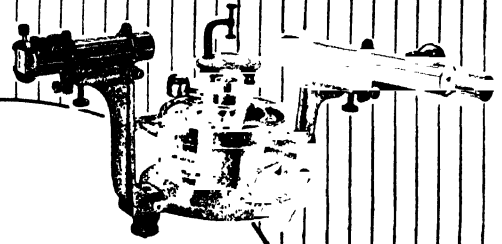
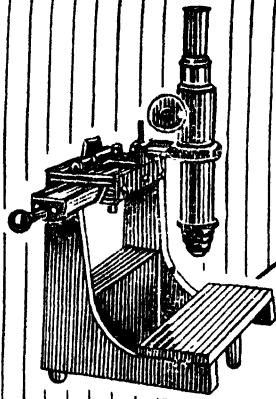

# KAYCEE

## SCIENTIFIC INSTRUMENTS

*for  
Accuracy*

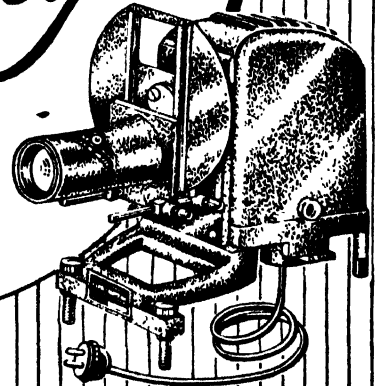
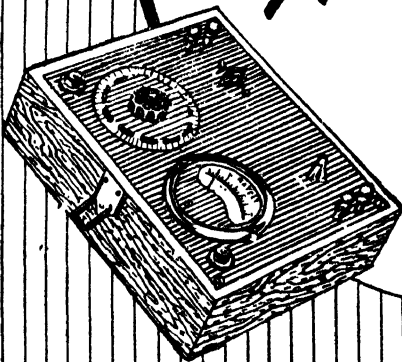

**RADIO LAMP WORKS LTD.**

BOMBAY · CALCUTTA · NEW DELHI · MADRAS · KANPUR · INDORE · WARDHA · GAUHATI

## COSMOLOGY\*

**T**HE universe in the large is an inevitable subject for scientific curiosity, but the most commonplace physics also leads us to study it. More generally, we conceive that the laws of physics and the actually existing physical universe must be interdependent, so that physics is bound to merge into cosmology. We may conveniently define cosmology to be the study of the astronomical universe as the system of the galaxies and any material in intergalactic space. The present time is suitable for taking stock of the subject because there seems to be a halt in its development, although much that is happening in physics and astronomy can be seen to have a bearing upon it.

The lines in the optical spectra of galaxies show a shift towards the red that increases with decreasing apparent brightness. The facts are consistent, to a good first approximation, with the interpretation that the galaxies are receding with speeds proportional to their distances. This interpretation received notable support when American observers recently found, in the few cases so far examined, that the 21 cm. line in the radio spectrum showed velocity shifts agreeing well with those in the optical spectrum. The constant of proportionality in the velocity law (Hubble's law) is written  $1/\tau$ ; it means that if the galaxies have always had their presently observed velocities they would all have coincided in space  $\tau$  years ago. The current estimate of  $\tau$ , based upon W. Baade's important revision of the distance-scale, is  $5.4 \times 10^9$  years.

The fact that so general a property as the motion of the galaxies is found to be the same for all directions, strongly indicates that the universe as a whole must be isotropic about our position. The homogeneity signifies that an observer in any other galaxy would get the same general picture of the universe as we do if the universe is in a steady state, or the same sequence of pictures if it is evolving. If valid, this is the most important thing we know about the universe, for, it means that we are in a position to know all that can be known about the astronomical universe, in the sense that we could learn nothing more about its large-scale behaviour by going anywhere else within it. If the universe is in a steady state, we could further learn no more by living at

another epoch, but this would not follow if the universe is evolving. It is in fact hard to see any justification for accepting the 'universality of physical law' unless there is also universality of physical background, i.e., homogeneity of the universe in the large. It is satisfactory to find evidence for the latter, at any rate as regards space; whether it applies also to time is one of the main points to be discussed.

The most obvious explanation of the apparent recession of the galaxies is that we are witnessing a one-way evolution of a universe whose contents are given once and for all. The mechanical behaviour of such a system is appropriately treated by Einstein's theory of general relativity. The equations obtained have a range of solutions. Those that come nearest to fitting the observations require the material to have been in a state of enormous density, infinite in the idealized model, rather less than  $\tau$  years ago. The production of this singular state is given no meaning in the theory; it must be regarded as the creation of the universe, and a unique 'age of the universe' must be dated from it.

On the other hand, the essentially simplest view is that we should suppose there to be nothing to distinguish our position in time from any other, just as we have already inferred that there is nothing to distinguish our position in space. Thus, we should suppose the universe to be in a steady state. This refers to the universe in the large or to the smoothed-out universe.

The steady-state theory of the expanding universe was propounded by H. Bondi and T. Gold and by F. Hoyle in 1948. According to the theory, existing galaxies are indeed dispersing, but, new matter is continually appearing throughout the universe and giving rise to new galaxies, thereby keeping the population distribution steady. Any large region contains galaxies of all ages, but with an average that works out at  $1/3 \tau$  years. The general merits of this theory are that we avoid (a) the dubious procedure of employing unchanging laws in a changing universe; (b) the paradox of finding objects such as stars that are older than the universe; (c) the dilemma of having everything dependent upon a creation process that nevertheless is outside the scope of the theory. However, it must be understood that discrimination between the different theories depend upon effect of second or higher order near the limits of instrumental performance.

---

\* Based upon an article by W. H. McCrea in *Endeavour* for January 1958.

Despite the superb work done by observers, it seems that all efforts to discriminate between the theories by means of large-scale features must still be inconclusive. This seems to apply not only to optical observations but also to radio surveys. At present therefore we must consider less direct evidence.

According to evolutionary theory, galaxies must have been formed from a space-filling gas at a definite stage in the expansion of the universe. But a satisfactory process has not so far been proposed.

The steady-state theory, however, by its very nature cannot pose the problem of an original formation of galaxies. D. W. Sciama has stressed that its problem is the self-perpetuation of the existing population with all its characteristics. He has outlined a remarkable solution of the problem which is as follows.

A galaxy is, in general, in motion through intergalactic gas by virtue of its random velocity. The gas that falls towards it as it passes, forms a wake behind the galaxy, as in the well-known theory of gravitational accretion. The wake material will tend to pull itself together by its self-gravitation and so forms a 'daughter' galaxy. There is a critical condition for the daughter to break away from her parent instead of remaining gravitationally bound. If they separate, the process will start again with each galaxy. If they remain together, the process will be repeated with the pair, and by the production of further offspring a cluster of galaxies of increasing population may result. But a cluster has an inherent tendency to lose members by 'evaporation'; this and other factors hinder its growth indefinitely. The galaxies that evaporate off maintain the distribution of random motions of the field galaxies. The characteristics of this self-perpetuating system depend ultimately upon the properties of the atomic hydrogen which constitutes the bulk of the intergalactic material postulated in the theory. The theory cannot yet be regarded as established but is attractive and has no arbitrary features.

Calculations imply that 90% of all matter is intergalactic and the mean density  $\rho$  according to original theory works out to  $3 \times 10^{-5}$  hydrogen atom cm.<sup>3</sup> According to the steady-state theory the existing matter moves out of any region as a result of cosmical expansion and is replaced by 'new' matter once in about  $2 \times 10^9$  years on the average. Thus there is a creation process which must be one involving fundamental particles and producing hydrogen. Consequently at some stage it must yield protons and electrons. Calculations reveal that over a big range of temperature there will be significant fractions of both neutral and ionized hydrogen.

The concept of continual creation has not proved repugnant to current physical theory. It has indeed provoked a further line of speculation. For, 'matter' constituted of positively charged nuclei and negative electrons, and 'anti-matter' constituted of negatively charged nuclei and positive electrons, are treated in symmetric fashion by current theory. In particular, both sorts have theoretically identical inertial and gravitational properties. On general grounds we might therefore expect any creation process to produce statistically equal amounts of matter and anti-matter and the universe in the large to be composed of equal amounts. On the other hand, any particular galaxy must be composed effectively entirely of one sort only. It has even been suggested that some very energetic collisions observed to be occurring in some parts of the universe are between galaxies of opposite compositions.

The steady-state theory has survived for nine years since its announcement. Despite its peculiar vulnerability, no observation has been found to refute it that is not itself of uncertain interpretation. The obstacle regarding nuclear synthesis has disappeared and with it one of the main arguments for the evolutionary theory. The solution of the problem of galaxy formation seems to be within reach of steady-state cosmology, while older theories have not shown much progress towards solving it.

---

#### HAFKINE INSTITUTE

**T**HE Haffkine Institute, Bombay-12, will be celebrating its Diamond Jubilee from 10th to 14th January 1959.

The celebrations are expected to be inaugurated by the President of the Republic of India. The programmes will include lectures and scientific seminars on topics such as plague, cholera, rabies, influenza, poliomyelitis,

snakes, venoms and insect resistance to insecticides. These will be on international level for participation.

All scientists, scientific organisations and learned societies are invited to attend or to send delegates so as to encourage free flow of research ideas and goodwill between Research Institutions in the world.

---

## NUCLEAR SPECTROSCOPY: STUDY OF ALLOWED AND FORBIDDEN BETA-SPECTRA

B. V. THOSAR

*Tata Institute of Fundamental Research, Bombay-1*

**P**RIOR to about 1950, nearly all the beta-decaying isotopes which were studied were found to give a continuous beta-spectrum conforming to the so-called 'allowed' shape, in accordance with the Fermi theory. During the last six or seven years, due mainly to the advent of atomic reactors, which could produce many artificial isotopes to high specific activity and also due to improvements in the design of beta-spectrometers, many instances of marked deviation from the 'allowed' shape have been revealed.

The shape of the beta-spectrum is one of the important criteria for deciding whether a beta-transition is allowed or forbidden under the selection rules.

The expression for energy spectrum according to Fermi theory is as follows:

$$N_{\pm}(W) dW \cdot \left(\frac{g^2}{2\pi^3}\right) F(\mp Z, W) \\ p.W. (W_0 - W)^2 S_n(W) dW.$$

$W$  = energy in units of  $mc^2$ ;  $Z$  = atomic number;  $p$  = momentum in units of  $mc$ ;  $g$  = constant of interaction.

Here,  $p.W.(W_0 - W)^2$  is the statistical factor obtained on the assumption that all modes of distribution of energy between the electron and the neutrino are equally probable. The term  $F(Z, W)$  is the correction term for the effect of the Coulomb field on the emitted electron and becomes important at lower energies and higher values of atomic number. Its effect is to increase the number of 'slow' electrons and to decrease the number of 'slow' positrons. The factor  $S_n(W)$  incorporates the specific nuclear properties relating to the initial and final states

$$\left[ (C_s^2 + C_t^2) |M_{\pm}|^2 + (C_1^2 + C_A^2) |M_{G-T}|^2 \right] \times \left( 1 \mp \frac{b}{W} \right)$$

of the nuclei. This shape factor may or may not be energy-dependent. It can be written as to take account of the Fermi and Gamow-Teller types of interactions. In the case of 'allowed' transitions this shape factor is independent of energy,  $b=0$ , and the spectrum shape is then the statistical shape, corrected for the coulomb field effect. The spectrum shape for allowed transitions is therefore not sensitive to the precise form of interaction involved in beta-decay.

The above expression for energy spectrum can be rewritten, for 'allowed' decays, as

$$\left[ \frac{N(W)}{F(Z, W) \cdot p.W.} \right]^2 = K (W_0 - W);$$

the quantity on the left plotted against energy  $W$  then gives a straight line, the Fermi-Kurie plot, with an intercept on the energy axis equal to  $W_0$ , the maximum beta-energy. The data on energy spectrum are presented in the form of a Kurie plot, which is a straight line for "allowed" decays, any true deviation from it being an indication that the transition in question is of the 'forbidden' type.

The selection rules governing beta-transitions are based on change in angular momentum,  $\Delta J$  and change in parity, between the initial and final states.

	$\Delta J$	Parity change
Allowed Transitions	0, $\pm 1$ ,	No
First forbidden Transitions	0, $+1, \pm 2$ ,	Yes
Second forbidden Transitions	$\pm 2, \pm 3$ ,	No

Thus,

While allowed transitions give a straight line Kurie plot, the converse is not true as most first forbidden transitions of the type ( $\Delta J=0, \pm 1$ , yes) also give the 'allowed' spectrum shape. The spectra of Radium E ( $Bi^{210}$ ) and  $Sb^{124}$  are, however, exceptions as they show a deviation from allowed shape. RaE spectrum is now explained as due to a combination of scalar and tensor interactions with  $\Delta J=1$ , yes and so also the spectrum of  $Sb^{124}$ . The explanation is

that there is an accidental cancellation of the usually dominant energy-independent terms in the spectrum shape correction factor so that the smaller energy-dependent terms begin to show up their influence.

Also, in decays where  $\beta - \gamma$  directional anisotropy exists, the spectrum shape, according to theory, must deviate from the 'allowed' shape, though the deviation may be small. For isotopes<sup>2</sup>,  $K^{42}$ ,  $As^{70}$ ,  $Rb^{86}$ ,  $I^{126}$ , such anisotropy exists, the transitions being of the type  $\Delta J=0$ ,



yes. No deviations from allowed shape have, however, been reported. For  $\text{Tm}^{170}$  and  $\text{Sb}^{124}$  ( $\Delta J = 1$ , yes),  $\beta - \gamma$  anisotropy and deviations from allowed shape have been found.

It would appear that beta-transitions of the first forbidden ( $\Delta J = 0, \pm 1$ , yes) type need to be more carefully studied. It has been surmised that deviations from allowed shape as predicted by theory would be more frequently revealed if experimental spectroscopy is made capable of detecting 3-5% deviations from the statistical shape.

Transitions of the type  $\Delta J = 2$ , yes, are in a special class, called 'first forbidden unique'. The unique shape factor,  $(W^2 - 1) + (W_0 - W)^2$ , gives an S-shaped uncorrected Kurie plot, with deviations from the allowed shape, both at low and high energies. Several examples of this type have been revealed in recent years, some of them being  $\text{Y}^{90}$ ,  $\text{Y}^{91}$ ,  $\text{Y}^{92}$ ,  $\text{Cs}^{137}$ ,  $\text{Tl}^{204}$ .

Second forbidden decays are not in general expected to conform to the allowed shape.

Comparative half-life 'ft' or half-life corrected for atomic number  $Z$  and maximum beta-energy,  $W_0$ , provides another criterion for deciding about the allowed or forbidden nature of a transition. Thus  $\log ft$  values seem to lie in the range 4.5 to 6 for normal allowed transitions for odd  $A$  (mass-number) nuclei and in the range 4 to 5.7 for even  $A$  nuclei.  $\log ft$  is around 3.5 for super-allowed decays, i.e., for neutron,  $\text{H}^3$  and the mirror-nuclei, and for first forbidden transitions it ranges from 6 to 8. The shape of the beta-spectrum, the  $\log ft$  value of the transition and considerations regarding the shell structure of nuclei are usually sufficient for determining the nature of the transition and the spins and parities of the initial and final nuclear states.

The deviations from allowed shape are significant at low energies, the curve bending upwards from the straight line Kurie plot. Experimental difficulties in working with beta-rays at these energies are considerable and a proper assessment of all possible sources of error is essential before reaching any definite conclusion about deviations from allowed shape. Some of these experimental considerations are as follows:

(1) Absorption in the window of the counter.

(2) Scattering of electrons in source material and from the source-backing.

(3) Spectrometer resolution correction, which can be tested by studying the shape of internal conversion lines in different regions of energy.

(4) Effect of the design of baffle-edges as penetration through the edges at high energies can affect the shape of the spectrum. A sharp-edged or sharp-cornered baffle in front of the detector can enhance the high energy portion ( $\sim 1.5$  Mev.) by several per cent.

(5) Stability of the detector.

(6) Remanence in the iron of spectrometer magnet, which may change its current-field characteristic.

Corrections for effects (1) and (2) above can best be assessed by a number of auxiliary experiments,<sup>3</sup> using different values of thickness for counter window and source-backing. A good experimental approach for eliminating several rather ill-defined errors is to use a method of comparison where the spectrum from a given source is compared, under identical conditions, with that of a source known definitely to give a straight-line Kurie plot. Greater confidence can then be placed even in small, observed deviations from the allowed shape.

In conclusion it may be said that the study of forbidden beta-transitions is essential as the expectations for such transitions are more sensitive to differences in the formulation of the theory than those for allowed decay. The recent discovery of non-conservation of parity in weak interactions has reopened the question of the type of interaction involved in beta-decay and has stimulated experimental investigation and re-examination of many problems<sup>4</sup> which were considered to have been settled.

1. *Beta and Gamma-Ray Spectroscopy*, Edited by K. Siegbahn, Articles by M. E. Bose, C. S. Wu and Konopinsky.

2. Porter, F. T., *et al.*, *Phys. Rev.*, 1957, **107**, 135 and *Ibid.*, 1956, **103**, 921.

3. Subba Rao, B. N., *et al.*, to be published.

4. Berestetsky *et al.*, *Nuc. Phys.*, 1958, **5**, 464.

## RECENT ADVANCES IN AIRPHOTO GEOLOGY

PETER E. WOLFE\*

**A**IRPHOTO Geology is a science dealing with the examination, interpretation and preparation of geologic maps from aerial photographs. The form, pattern, and broader relation of rock bodies can be studied more quickly and more effectively on photos than on the ground and in many instances features or relations which are absent to the observer in the field are readily apparent on photos. The aerial camera is an extremely efficient recorder of many of the important field data and provides a means literally of bringing the field into the laboratory. Airphotos likewise provide the most economic means of surveying and result in more detailed geologic maps at a fraction of the cost of older field surveying methods.

The geologic interpretation of aerial photographs requires a well rounded knowledge of general geology. Familiarity with geologic maps and with the solid geometry of rock bodies is important and field experience is invaluable as a background. Any type of airphoto may be used for geologic interpretation, the relative merits of each depending on the particular problem at hand. For reconnaissance work, oblique photographs and mosaics are advantageous for studying large-scale features and trends. Vertical photographs with stereoscope coverage are best for detailed work especially since they may be viewed in three dimensions and the relief or terrain features studied in conjunction with the rock outcrop and structural patterns.

Aerial photographs may be used for geologic mapping either in the office or in the field. Office mapping is obviously limited in scope and its success is dependent upon adequate exposures. Under favourable conditions, photos alone may supply a large part of the information needed in mapping, but they can never supply quite all the necessary data. Office mapping consists essentially in the systematic applications of the criteria for lithologic, structural and topographic interpretation of aerial photographs. In economic geology it is sometimes necessary to obtain, in a minimum amount of time, all possible information about areas which are not readily accessible from the ground, such as in rough mountainous re-

gions, jungle areas, etc. In such cases provisional maps may be prepared solely on the basis of aerial photos. The boundaries of rock types may or may not be shown. In some instances it may be sufficient to show only the general structural trends using appropriate symbols for faults, axial traces of anticlines and synclines, dip and strike of strata and outcrops of igneous rock bodies. The reliability of this type of mapping varies inversely with the complexity of structure. Although a thoroughly accurate map may be prepared under ideal conditions, there are many sources of error and the results are provisional until confirmed in the field.

In geologic field mapping, aerial photographs may be used both as guide maps in finding desired localities and outcrops and as base maps for recording geologic data. As guide maps they are unexcelled, providing a complete and detailed picture of roads, trails, clearings, streams, ridges and landmarks of all types, as well as showing the places where outcrops can be found. Generally it is possible to locate oneself very quickly by visual comparison with the ground features and the photographic detail. Using airphotos, it is possible at the beginning of each day's work to plan the traverses in considerable detail. Promising points for investigation are noted and the best routes between points are decided upon. In this way, small but important exposures which otherwise might be found only by chance, may be located and conversely, unpromising areas may be excluded from the traverse route. On the completion of a given unit of the field work, the photos provide a basis for interpolating boundaries between points visited, as well as integrating scattered observations on general geology and finalizing a detailed geologic map.

The basic phases of geologic interpretation from aerial photos include the identification and delimitation of rock structure and interpretation of landforms and drainage patterns. Structural interpretation is mainly a matter of determining the solid geometry of the rock bodies. Accurate differentiation and correlation of lithologic units constitutes the first step and is followed by a study of the distribution and attitude of the geologic formations and their relations to one another. Where the rocks involved in the structure are fully exposed, as in arid regions of some relief, their structural

\* The author is a Visiting Professor of Geology at the Osmania University under a grant from the United States Educational Foundation in India.

relations may be observed and mapped directly. Where the structures are not directly exposed, but the outcrop belts of certain distinctive rocks are traceable through the soil and vegetation, the type of structure may be deduced from the outcrop pattern and its relation to topography and vegetative cover. Stream drainage patterns likewise are valuable as indicators of general structural trends. Dendritic or tree-like patterns indicate areas of horizontal sedimentary or uniform igneous rocks. Trellis patterns indicate folded sedimentary rocks with anticlinal, synclinal and monoclinal structures; radial patterns show domal structures, etc. The approximate dip and strike of rocks can likewise be easily measured through stereoscopic or three-dimensional studies of vertical photographs. The geologic identification and delimitation of rock types and structure and the interpretation of drainage patterns and terrain are closely interrelated and together lead to more specialised phases such as its application to mining, petroleum and engineering geology and research problems in dynamic geology.

In the mining industry aerial photographs are widely used for the discovery and development of new mineral deposits and extension of old ore bodies. During the past 25 years large areas of the United States, Canada, Africa, South America, Australia and other countries have been photographed and air-borne magnetometer surveys made in order to discover new mineral deposits. These surveys were made partly for the purpose of providing base maps and partly to permit a direct search for such evidences of mineralization as might be shown on the photos. Insofar as primary ore deposits are concerned the latter is mainly a matter of lithologic and structural interpretation involving the recognition of actual outcrops of gossan, mineralized aureoles, veins or lodes, or of rock bodies or other geologic relations which might be expected to have mineral deposits associated with them. Careful study of the aerial appearance of known ore deposits provides a guide in the search for other deposits of a similar character in the general region. Thus, through a detailed examination of aerial photographs, areas which appear promising for ground prospecting are selected, and areas which appear to be unfavourable are eliminated.

In the detailed study of established mining districts, aerial photos are valuable for routine surface mapping of the geology. This involves the plotting of all outcropping veins or other

type of deposits, together with associated faults, folds, fractures and lithologic units which may have influenced the localization of the ore. Minor fractures, faults, and other features difficult to recognise on the ground are frequently shown very clearly on photos and when their relation to mineralization has been established may provide a clue to new ore bodies. Likewise the use of the air-borne magnetometer in conjunction with aerial surveys has been valuable in discovering new ore deposits. In the United States one of the large steel companies, which imports iron from mines more than a thousand miles away, carried out a magnetometer survey on land-holdings adjacent to their steel plant. Much to their surprise a large new magnetite iron ore body was discovered in their own backyard. The extension of large nickel deposits in Canada also were made using similar air-borne surveys.

The costs of aerial photo surveys in mining operations varies according to the size and shape of the area, scale of the maps, amount of existing ground control and detail required. For areas of 1,000 acres or larger, the air-borne method always costs less than ground surveys. For example, the mapping of a 7,000-acre coal mining area in the Central United State cost \$1.84 per acre whereas ground surveys for a nearby area of similar size with identical terrain cost \$2.92 per acre. Furthermore, much more detail was furnished in the aerial maps which was invaluable in planning the long-term mining operations.

The monetary savings in air-borne magnetometer surveys are even more striking. For example, in the Adirondack Mountain area of Upper New York State, a large magnetite iron ore deposit was located through air-borne surveys. During this aerial survey, a 4-man crew operating an aircraft made 11,300 miles of magnetic traverse lines spaced  $\frac{1}{4}$  mile apart. It was estimated that, under the rugged mountainous terrain present, a 4-man crew making a dip needle ground survey would have required 27 years of six-month field seasons or 80 times the period and have cost 17 times as much as the aerial surveys. The final results also would have been much less accurate and the development of the mining operations would have been delayed by many years.

In the petroleum industry the use of aerial photos both for geological and engineering purposes has become standard practice. Aerial photographs provide a rapid and economic means of preparing base maps of various types and scales, particularly in unmapped or

inadequately mapped territory, and thus aid in many phases of developmental work. Surface indications of petroleum such as oil seeps, anticlinal structures, and other types of potential structural traps are often shown with striking clarity on aerial photos. In undeveloped jungle country difficult of access, aerial photographs provide the only guide and efficient way

ocean platforms and continental shelves, aerial photographs provide the only means of accurately locating the subsurface structures. Extensive use of aerial photos in conjunction with 'shoram' and air-borne magnetometer surveys have been made in the West Indies and Gulf of Mexico in developing new oil-fields in submerged continental shelf areas.



FIG. 1. Oblique Aerial Photograph showing Planed-off Structural Dome in Mauritania, French West Africa

of locating either definite structures or places where there is some hope that such structures may be outlined by ground methods. They aid furthermore in appraising the regional geologic setting of individual areas and in selecting the best routes to places of seeing promise for ground study. In this way random traverses are avoided, much fatiguing and unprofitable travel is eliminated, the range of geologic exploration is greatly extended, and essential field work is held to a minimum. Again in the exploration for oil in offshore areas along the

In the field of Engineering Geology, air-photos find widespread application. They provide a base map for the preliminary surveys or mapping required for many types of engineering projects. Skilled geologic and physiographic interpretation of the photos may aid both in contributing to the economy and efficiency of purely routine geologic work, and in directing attention to such features as active faults, sinkholes, landslides, glacial deposits and ancient stream channels which might have an important bearing on the cost or success of

the project in question. In light of the information thus gained, boreholes, test pits, or trenches, or other types of subsurface exploration may be planned most effectively. In detailed geologic mapping of sites for tunnels, aqueducts, dams, reservoirs and other types of engineering projects, faults, fractures, and other sources of weakness in the rock are of particular concern and aerial photos might direct attention to minor but important structures, which might otherwise be overlooked. Ancient landslide masses frequently constitute obstacles to the building of dams and other structures and their recognition is of considerable importance. The presence of old slides, furthermore, might suggest the possibility of repeated sliding and the desirability of suitable precautionary measures. In cases where highways, railways, canals, and dams are damaged or obstructed by active landslides, aerial photographs provide the quickest way of obtaining a complete picture of the situation and the

remedial measures to be taken. Aerial photos are very helpful in studying the effects of the silting of reservoirs and the control of erosion and deposition along rivers and harbours. They also are invaluable for the development of new surface and subsurface water-supplies, dam, reservoir and irrigation projects.

In conclusion the descriptions given above indicate in a brief way the advances that have been made in air-photo geology and their economic applications. The author cannot recommend too highly the widespread use of air-photos for geologic work. Not only are aerial surveys less costly than ground surveys, but they add to greater detail and accuracy. Air-photo geologic surveys likewise can be carried out in a fraction of the time of ground surveys; sometimes advancing the development of a mineral prospect by many years. In advanced civilizations, time is an important element and air-photo geology is an important new scientific tool.

---

### ORTHO-PARA-CATALYSIS IN LIQUID-HYDROGEN PRODUCTION

FRESHLY liquefied hydrogen that has not been catalyzed consists of a 3-to-1 *ortho-para*-mixture. There is a slow but definite change in the mixture on standing, which complicates the problem of keeping the liquid for any great length of time. The exothermic heat of conversion of *ortho*- to *para*-hydrogen at 20° K. is about 254 calories per mole, whereas the endothermic heat of vaporization of liquid hydrogen is 216 calories per mole. As a result of this slow change, a thermally isolated tank of liquid hydrogen, prepared without conversion to the *para* form, will lose about 18% of its volume during the first day of storage. In the absence of this internal evolution of heat, the heat transfer to a well-insulated Dewar may result in a loss of less than 1% per day.

The obvious solution of the above difficulty is the conversion to the *para* form either in the gas phase before liquefaction or in the liquid phase immediately after liquefaction, but in any case before delivery to the storage Dewar.

Bonhoeffer and Harteck were the first to make use of heterogeneous catalysis to establish *ortho-para*-equilibrium. They used charcoal at liquid-air temperatures and were able to establish equilibrium quickly when normal hydrogen was passed over the catalyst. However, when *para*-hydrogen was passed over charcoal at room temperature, no conversion took place.

Taylor and collaborators studied the catalytic activity of the metallic oxides and found that the *para*-magnetic substances chromic oxide, cerium oxide, and neodymium oxide brought about rapid conversion, whereas zinc oxide, lanthanum oxide, and vanadium pentoxide, having low or negligible *para*-magnetism, showed low or negligible conversion efficiencies. They conclude that the magnetic character of the surface of the catalyst is a controlling factor and may account for their earlier success with metallic nickel, as well as for the results of Emmett and Harkness with Van der Waal's adsorption on iron synthetic ammonia catalysts.

A series of selected or specially prepared catalysts were studied for their ability to accelerate the *ortho*- to *para*-conversion of hydrogen. The results of this study are presented, and the performance of various catalysts are compared with that of chromic oxide on alumina pellets. An outstanding catalyst, unsupported hydrous ferric oxide granules, was selected for further study and used in the liquefiers of the National Bureau of Standards Cryogenic Engineering Laboratory. One and half litres of this catalyst has now been used to convert more than 100,000 litres of liquid hydrogen to 90-95% *para* at an average rate of about 235 litres of liquid per hour. There is to date no evidence of decrease in efficiency with continued use.

## STACKING FAULTS IN CLOSE-PACKED METALLIC LATTICES

### Part II. The Measurement of Faulting Parameters

T. R. ANANTHARAMAN

*Department of Metallurgy, Indian Institute of Science, Bangalore-3*

#### X-RAY DIFFRACTION FROM FAULTED CLOSE-PACKED LATTICES

**I**N Part I of this review<sup>1</sup> some general considerations were set forth and in this the quantitative estimation of stacking faults by X-ray methods will be dealt with. Detailed treatments for the X-ray diffraction effects of f.c.c. and h.c.p. lattices containing growth of deformation faults have been given by several authors.<sup>2-6</sup> A simple composite picture of the diffraction effects for the four different faulted lattices has not, however, been given so far.

The X-ray reflections from a structure which builds up in accordance with a space group can be represented in a reciprocal lattice where the lattice points, each representing a particular reflection, are similar, *i.e.*, identical except in intensity. In the case of f.c.c. and h.c.p. structures, it is possible to represent the corresponding reciprocal lattices in a common diagram with conventional hexagonal indices

(Fig. 1). The corresponding hexagonal indices

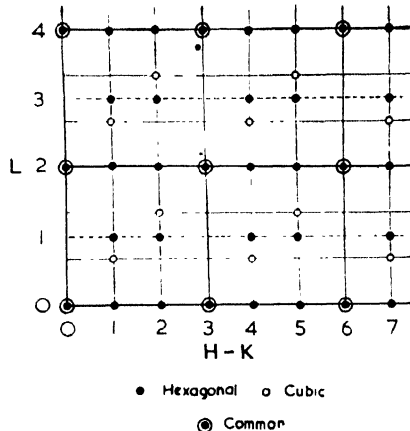

FIG. 1. Reciprocal lattice for close packed structures (Reflections from both h.c.p. and f.c.c. lattices are indicated.)

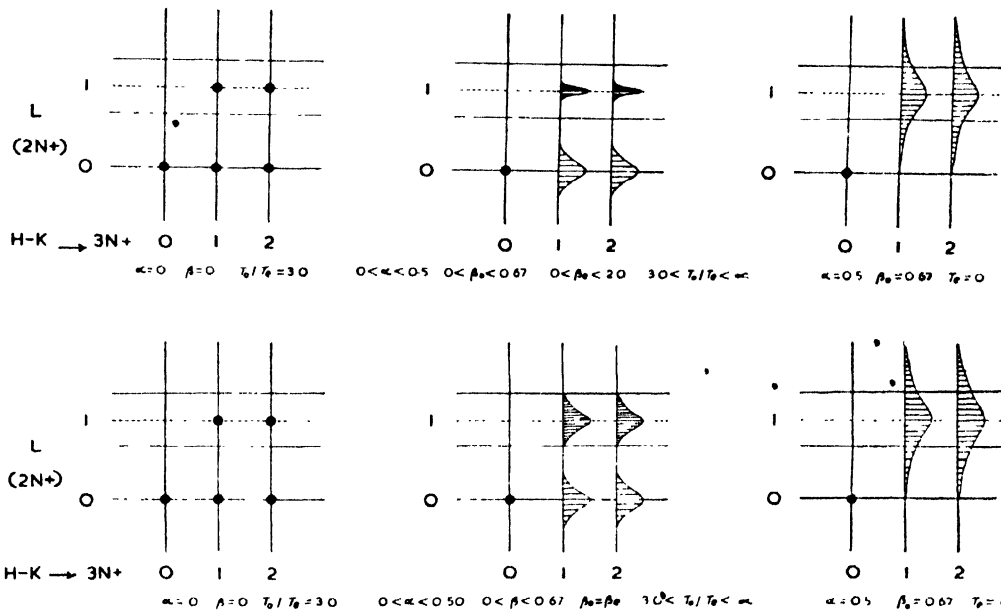

FIG. 2. Reciprocal lattice representation of X-ray diffraction effects of stacking faults in h.c.p. structures (The line profiles indicate distribution of intensity along the L-axis. Effects of growth and deformation faults are shown above and below respectively.)

HKH + KL) for f.c.c. reflections (*hkl*) can be computed from the simple relations:

$$H = \frac{(-h+k)}{2}; \quad K = \frac{(-k+l)}{2}; \quad L = \frac{(h+k+l)}{3}$$

The first few f.c.c. reflections, some of which actually represent a family of reflecting planes, can then be assigned the following hexagonal indices:

- (111) .. 2 parts (0002); 6 parts (10 $\bar{1}$ -2/3)  
 (200) .. All six parts (10 $\bar{1}$ -4/3)  
 (220) .. 6 parts (11 $\bar{2}$ 0); 6 parts (10 $\bar{1}$ -8/3)  
 (311) .. 12 parts (11 $\bar{2}$ 2); 6 parts (10 $\bar{1}$ -10/3);  
           6 parts (20 $\bar{2}$ -2/3);  
 (222) .. 2 parts (0004); 6 parts (20 $\bar{2}$ -4/3)  
 (400) .. All parts (20 $\bar{2}$ -8/3).

The similarity of points in such a lattice is affected by the introduction of stacking faults in either the ABCABC— or the ABABAB— sequence. The reflections with  $H - K = 3N$  ( $N$  being an integer or zero) and  $L$  even are not affected in any way by faulting; they are sharp and have the same intensity as in the perfect lattice. But all other reflections broaden out along the  $L$ -axis and in some cases also decrease or increase in intensity. These effects due to faulting are indicated diagrammatically in Figs. 2 and 3 and are described in the following section.

#### RESULTS FOR DIFFERENT TYPES OF FAULTING

(a) *Hexagonal Growth Faulting* (Fig. 2).—For reflections with  $H - K = 3N \pm 1$  and  $L$  even:

$$\text{Integrated Intensity} \quad \dots = K \left\{ \frac{1}{2} + \frac{(1-a)}{2\sqrt{4-8a+a^2}} \right\}$$

$$\text{Integral Breadth} \quad \dots \quad \beta_l = \left\{ \frac{4-4a-2\sqrt{4-8a+a^2}}{a} \right\}$$

where  $K = a$ , constant;  $a =$  frequency of faulting and  $\beta =$  integral breadth obtained by dividing total intensity ( $T$ ) integrated between  $(L+1)$  and  $(L-1)$  by the maximum intensity.

For reflections with  $H - K = 3N \pm 1$  and  $L$  odd:

$$\text{Integrated Intensity} \quad \dots \quad T_o = K \left\{ \frac{1}{2} + \frac{(1-a)}{2\sqrt{4-8a+a^2}} \right\}$$

$$\text{Integral Breadth} \quad \dots \quad \beta_o = \left\{ \frac{4-4a-2\sqrt{4-8a+a^2}}{3a} \right\}$$

Accordingly, all reflections with  $H - K = 3N \pm 1$  and  $L$  odd or even, broaden out in the  $L$  direction when growth faults are gradually

introduced into the lattice. The reflections with  $L$  even broaden out exactly *three* times as much as those with  $L$  odd. They also gradually lose their intensity in favour of the latter. At  $a = 0.5$ , the reflections with  $L$  even disappear and those with  $L$  odd increase in intensity by a third of their original values and attain their maximum breadth of 0.67 (in terms of  $L$ ). When  $a$  exceeds 0.5, the structure enters the f.c.c. region and can be considered a heavily growth-faulted f.c.c. structure.

Table I gives the integral breadths ( $\beta_o$  and  $\beta_e$ ) for reflections with  $H - K = 3N \pm 1$  and  $L$  odd or even, the ratios ( $T_o/T_e$ ) between the integrated intensities of reflections with  $L$  odd and even and the increase in intensity ( $\Delta T$ ) of the lines with  $L$  odd, for various values of the faulting parameter ( $a$ ).

TABLE I  
X-ray diffraction effects of stacking faults in h.c.p. structures

$a$	$\beta_o$	$\beta_e$	$T_o/T_e$	$\Delta T_o$
(a) Effects of Growth Faults				
0.0	0.00	0.00	3.00	0.0%
0.1	0.06	0.17	3.02	0.2%
0.2	0.13	0.38	3.10	0.8%
0.3	0.22	0.67	3.33	2.6%
0.4	0.37	1.10	4.16	7.5%
0.5	0.67	..	$\infty$	33.3%
(b) Effects of Deformation Faults				
0.0	0.00	0.00	3.00	0.0%
0.1	0.16	0.16	3.82	5.7%
0.2	0.32	0.32	5.52	12.9%
0.3	0.49	0.49	10.23	21.5%
0.4	0.62	0.62	35.25	22.7%
0.5	0.67	0.67	$\infty$	33.3%

(b) *Cubic Growth Faulting* (Fig. 3).—The reflections with  $H - K = 3N \pm 1$  and  $L = 2M + 2/3$  or  $4/3$  (where  $M$  is an integer or zero) are affected in a complex way by the introduction of growth faults. As soon as one growth fault is introduced, each reflection splits up into two, corresponding to the alter-

native twinned arrangements of the f.c.c. lattice. As  $a$  increases from zero, the sharp twin reflections broaden out *asymmetrically* with

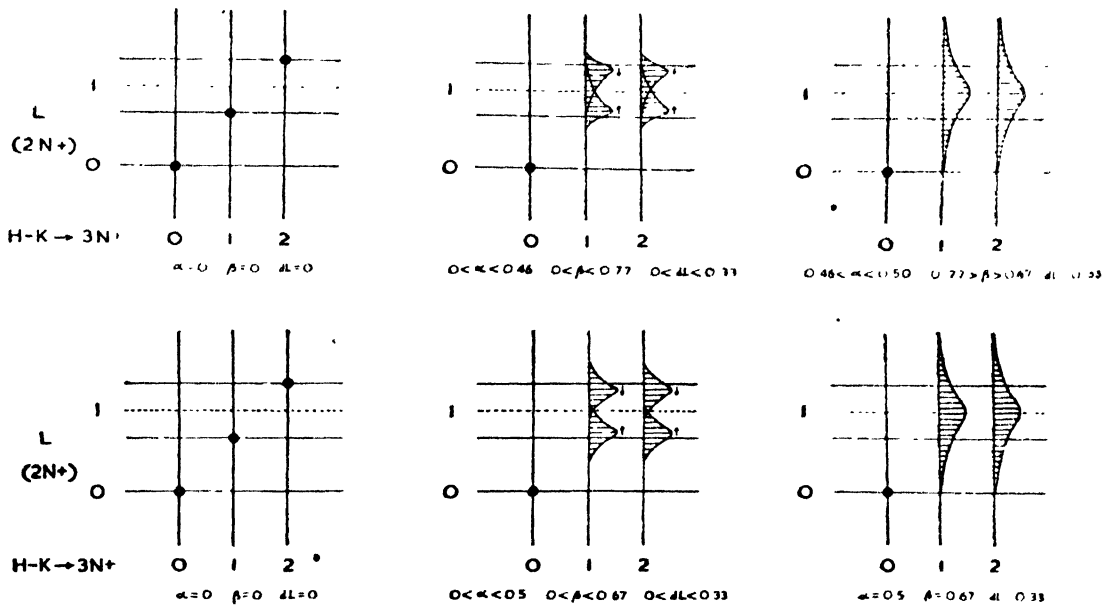

FIG. 3. Reciprocal lattice representation of X-ray diffraction effects of stacking faults in f.c.c. structures (The line profiles indicate distribution of intensity along the L-axis. Effects of growth and deformation faults are shown above and below respectively.)

their peaks moving towards each other. The intensity distribution of each asymmetrical component falls off more rapidly in the direction leading to  $L = 2M + 1$ . At  $\alpha = 2\sqrt{3} - 3$ , these two components coalesce into a single broad symmetrical line with the peak exactly at  $L = 2M + 1$ . The integral breadth given by  $\beta = 2(1 - \alpha)/3\alpha$  for the range  $\alpha = (2\sqrt{3} - 3)$  to  $1/2$  has the maximum value of 0.77 for  $\alpha = 2\sqrt{3} - 3$ . In the region  $(2\sqrt{3} - 3) < \alpha < 1/2$ , the breadths of these reflections start decreasing according to the above expression for  $\beta$  and reach the value of 0.67 for  $\alpha = 0.5$ . When  $\alpha$  exceeds 0.5, the structure enters the h.c.p. region.

The integral breadths as well as shifts in peaks for the range  $0 < \alpha < (2\sqrt{3} - 3)$  cannot be easily evaluated.

(c) Hexagonal Deformation Faulting (Fig. 2).—For reflections with  $H - K = 3N \pm 1$  and  $L$  odd or even.

Integrated Intensity ..

$$T_e = K \left\{ \frac{1}{2} - \frac{1}{4\sqrt{1-3\alpha+3\alpha^2}} \right\}$$

$$T_o = K \left\{ \frac{1}{2} + \frac{1}{4\sqrt{1-3\alpha+3\alpha^2}} \right\}$$

Integral Breadth ..

$$\rho_e = \rho_o = 2 \cdot \frac{1 - \sqrt{1-3\alpha+3\alpha^2}}{1 + \sqrt{1-3\alpha+3\alpha^2}}$$

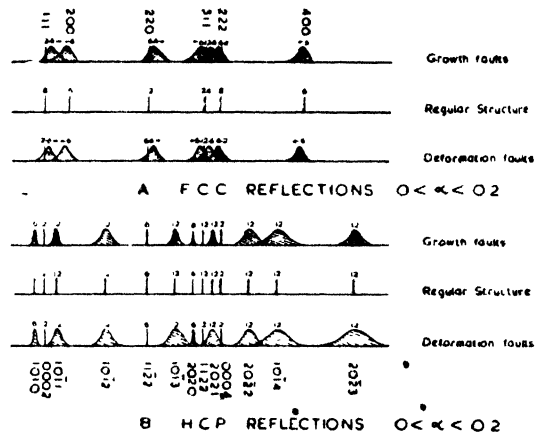

FIG. 4. Influence of stacking faults on X-ray powder photographs of close packed structures. (The small numbers refer to multiplicity factors of the reflections. The arrows refer to the direction of shift of the peaks.)

With the introduction of deformation faults



in the lattice, all reflections with  $H - K = 3N \pm 1$  and  $L$  odd or even, broaden out in the  $L$  direction. The lines with  $L$  odd or even broaden out to the same extent, however, unlike in the case of growth faulting. The reflections with  $L$  even start losing their intensity in favour of those with  $L$  odd, the change in intensity being far more rapid than in growth faulting. At  $\alpha = 0.5$ , the reflections with  $L$  even disappear and those with  $L$  odd increase in intensity by a third of their original values and attain the maximum breadth of 0.67. When  $\alpha$  exceeds 0.5, the process is just reversed and all reflections become sharp again at  $\alpha = 1.0$ . Table I b gives values of integral breadths, intensity ratios, etc., for various values of  $\alpha$ .

(d) *Cubic Deformation Faulting* (Fig. 3).—All reflections with  $H - K = 3N \pm 1$  and  $L = 2M + 2/3$  or  $4/3$  split up into pairs and broaden out in the  $L$  direction on the introduction of deformation faults also, but the components are *symmetrical* now with their maxima moving towards  $L = 2M + 1$ .

$$\text{Integral Breadth} \quad \dots \quad \beta = 2 \cdot \frac{1 - \sqrt{1 - 3\alpha + 3\alpha^2}}{1 + \sqrt{1 - 3\alpha + 3\alpha^2}}$$

$$\text{Shift in Maximum} \quad \dots \quad dL = \pm \left\{ \frac{1}{3} - \frac{1}{\pi} \arctan \sqrt{3 \cdot (1 - 2\alpha)} \right\}$$

At  $\alpha = 0.5$ , the peaks are at  $L = 2M + 1$  for the single lines and the maximum breadth of 0.67 is reached. Further increase in  $\alpha$  results in a reversal of the process with regard to integral breadths and a continuation in the movement of the peaks. At  $\alpha = 1.0$ , sharp reflections occur at  $L = 2M + 4/3$  or  $2/3$  as for the perfect twin of the original crystal.

Table II gives the values of integral breadths ( $\beta$ ) and shifts in peaks ( $dL$ ) for different values of  $\alpha$ .

TABLE II  
X-ray diffraction effects of deformation faults  
in f.c.c. structures

$\alpha$	$\beta$	$dL$
0.0	0.00	0.00
0.1	0.16	0.03
0.2	0.32	0.08
0.3	0.49	0.14
0.4	0.62	0.23
0.5	0.67	0.33

#### APPLICATION OF RESULTS TO POWDER PHOTOGRAPHS

The preceding results can be used to detect and evaluate stacking faults in close-packed structures from their Laue, Oscillation or

Debye-Scherrer photographs. The Laue and Oscillation photographs reveal streaks as predicted by theory and can be used to identify the type of faulting. They are unsuitable, however, for quantitative work. The frequency of faults is therefore invariably determined from powder photographs.

The general effects of different types of stacking faults in close-packed lattices on Debye-Scherrer reflections are indicated in Fig. 4 for small values of  $\alpha$  as are normally encountered in practice. Most powder reflections from f.c.c. lattices are made up of a number of X-ray reflections and the contribution of each of the latter has to be taken into account in determining the integral breadth or shift in peak for a particular line in the X-ray photograph. This is easily done by calculating and examining the hexagonal indices of each component of a cubic ( $hkl$ ) family.

Another important effect brought out in Fig. 4 is the relatively greater broadening shown for the same faulting frequency by lines with

higher  $L$  values in a family of reflections having same  $H$  and  $K$  values. This is because the spread of deviation angle for a small variation in  $L$  is greater in powder photographs for higher numerical values of  $L$  when  $H$  and  $K$  are the same. This effect can be taken into account by differentiating with respect to  $L$ :

$$\sin^2 \theta = \lambda^2 \cdot \left\{ \frac{H^2 + HK + K^2}{3a^2} + \frac{L^2}{4c^2} \right\}$$

the equation connecting the Bragg angle ( $\theta$ ), wavelength of the X-radiation ( $\lambda$ ), hexagonal lattice parameters ( $a$  and  $c$ ) and the indices of reflection ( $HK\bar{H} + KL$ ). The differentiation leads to:

$$d\theta = \frac{\lambda^2 \cdot L \cdot dL}{2c^2 \cdot \sin 2\theta}$$

Since  $2d\theta$  represents the measurable angular breadth ( $\beta_\theta$ ) due to diffraction for a powder line and  $dL$  represents the integral breadth in reciprocal space ( $\beta$ ) which is needed for the evaluation of  $\alpha$ , the above equation can be written as:

$$\beta = \frac{c^2 \cdot \beta_\theta \cdot \sin 2\theta}{\lambda^2 \cdot L}$$

$\alpha$  is normally evaluated from graphs connecting  $\alpha$  and  $\beta$ .

## MEASUREMENT OF FAULTING PARAMETER

The values of  $\alpha$  can be obtained from any of the following data available from powder photographs:

- (a) Shifts in intensity maxima (for f.c.c. structures only).
- (b) Integral breadths due to diffraction alone.
- (c) Integrated intensities (for h.c.p. structures only).
- (d) Line shapes.

The observed line-broadening is due in many cases both to stacking faults and deformation of the lattice. The separation of these two effects is very difficult. In such instances, method (a), applicable only to f.c.c. materials, is eminently suitable, as broadening due to internal strains does not result in a shift of the peak position. The location of the  $K\alpha_1$  peak of a composite broadened line may be measured accurately by a graphical<sup>7</sup> or an analytical<sup>8</sup> method. It is not satisfactory to compare the peak position with the predicted position because of the systematic errors which influence the apparent peak position in all powder photographs. Instead, the measured separation of adjacent lines may be compared with the corresponding separation in annealed (unfaulted) materials photographed under the same conditions. Reasonable confidence in the interpretation of results is obtained only if several such separations are measured on one film and give the same value of  $\alpha$ .

There is no movement of peak positions in the case of reflections from faulted h.c.p. structures and hence method (a) is not suitable for hexagonal materials. Method (b) is the most usual for these structures and gives reliable results if the line profiles are determined accurately by careful photometering or by Geiger counter methods. Suitable corrections have to be applied, however, for geometrical broadening<sup>9</sup> and for intensity lost in photometering.<sup>2,9</sup> In cases where internal strains also contribute to line-broadening, the systematic variation in integral breadths of lines not affected by faulting must be taken into consideration. The results may again be regarded as satisfactory only if the values of  $\alpha$  obtained from a number of different lines are in reasonable agreement. A further check is obtained if the same specimen is photographed with several different

radiations, so that the geometrical conditions for a given reflection are varied. This check will establish whether or not true diffraction broadening is measured.

Measurement of integrated intensity of a line is necessary in order to obtain its breadth. Its use in determining  $\alpha$  (Method c) is however purely subsidiary, since measurements of breadth are much more accurate than those of intensity. Moreover, the rate of change of intensity with  $\alpha$  is usually too small for the values of  $\alpha$  encountered in practice.

Method (d), in which the line shape is expressed as a Fourier series,<sup>10</sup> is probably the best way of obtaining the maximum information from any one line. Internal strain and faulting effects can be separated in this method from the relation between successive Fourier coefficients.<sup>9,11,12</sup> Its use becomes very tedious, however, when a number of specimens have to be examined to find the effect of external variables on the amount of faulting. For ordinary work, the measurement of shifts in line peaks and integral breadths seems to be almost as accurate and definitely more convenient, provided all the precautions detailed above are taken.

## CONCLUSION

Interest in the detection and accurate measurement of stacking faults in close-packed metallic lattices has been increasing steadily in recent years as evidenced by the number of papers published on this subject. The importance of work in this fascinating field of research is bound to grow in coming years as the study of stacking faults seems to be closely bound with the development of the theory of dislocations as well as theories of work-hardening.

1. Anantharaman, T. R., *Curr. Sci.*, 1958, **27**, 238.
2. Wilson, A. J. C., *Proc. Roy. Soc.*, 1942, **180 A**, 277.
3. Jagodzinski, H., *Acta Cryst.*, 1940, **2**, 201.
4. Paterson, M. S., *J. Appl. Phys.*, 1952, **23**, 805.
5. Gevers, R., *Natuurwet. Tijdschr.*, 1953, **35**, 25.
6. Christian, J. W., *Acta Cryst.*, 1954, **7**, 415.
7. Rächinger, W. A., *J. Sci. Inst.*, 1948, **25**, 254.
8. Anantharaman, T. R. and Christian, J. W., *Brit. J. Appl. Phys.*, 1953, **4**, 155.
9. — and —, *Acta Cryst.*, 1956, **9**, 479.
10. Stokes, A. R., *Proc. Phys. Soc.*, 1948, **61**, 382.
11. Warren, B. E. and Averbach, B. L., *J. Appl. Phys.*, 1952, **23**, 497.
12. Williamson, G. K. and Smallman, R. E., *Acta Cryst.*, 1954, **7**, 574.

**THE PHOTOLYSIS OF URANYL OXALATE AND THE PREPARATION OF  
URANIUM (IV) OXYOXALATE AND OXALATE**

D. PATNAIK AND B. SAHOO

*Department of Chemistry, Ravenshaw College, Cuttack-3*

**T**HE photolysis of uranyl oxalate, on account of its application in actinometry, has been extensively investigated.<sup>1-3</sup> The uranyl ion  $UO_2^{2+}$  is reduced to the uranium (IV) state with simultaneous oxidation of oxalic acid to  $CO_2$ ,  $CO_2$  and  $H_2O$ . Both the ionic species  $U^{4+}$  and  $UO_2^{2+}$  represent the uranium (IV) state and it is obvious that the former would give the oxalate  $U(C_2O_4)_2$  and the latter the oxyoxalate  $UO(C_2O_4)$ . Thus the formation of the oxalate or the oxyoxalate depends on the conditions of photolysis in which the uranyl ion either reduces to  $U^{4+}$  or  $UO_2^{2+}$  ionic state. Uranium (IV) oxalate is obtained as a dark green precipitate when a solution of uranyl salt with oxalic acid is exposed to sunlight.<sup>4</sup> The method of preparation of Marchi<sup>5</sup> of this compound involves the reduction of  $UO_2^{2+}$  in hot HCl solution by solid sodium thiosulphate. The preparation of uranium (IV) oxyoxalate has not hitherto been reported. Though Büchi<sup>6</sup> found formic acid as one of the products of photolysis of uranyl oxalate, yet no importance was attached to this observation so far as the role of formate ion in the photolysis is concerned. When we exposed a mixture of saturated solution of uranyl formate and oxalic acid in the ratio of 1 : 6 to

sunlight for 8-10 hours, a dirty green precipitate was obtained. After filtration, the precipitate was washed several times with distilled-water and dried in a desiccator for 15-20 hours at the room temperature. The analysis of this compound was carried out as described below and the analytical data recorded in Tables I and II show that the compound is hydrated uranium (IV) oxyoxalate having the formula  $UO(C_2O_4)_2 \cdot 6H_2O$ .

The molecular weight was determined from the oxide  $U_3O_8$  obtained by heating weighed quantity of the compound in platinum crucible. It was also determined from the total oxidisable content, U(IV) and oxalate ions, which was estimated by titrating solutions of the weighed amounts of the substance in 6N.  $H_2SO_4$  against standard  $KMnO_4$  solution. That part by weight which would require 4 litres of N.  $KMnO_4$  solution would represent the molecular weight of the compound. Separate determinations of uranium and oxalate contents were also done; the former by Jones reductor method<sup>7</sup> and the latter by titrating the acidified filtrate, obtained after hydrolysis of the compound in sodium hydroxide, against standard permanganate solution. The analytical data recorded in

TABLE I  
*Mol. wt. (theoretical)—450*  
*Mol. formula:  $UO(C_2O_4)_2 \cdot 6H_2O$*

Compound taken	$U_3O_8$ found	Mol wt. computed	Compound taken	Vol. of N/10 $KMnO_4$ required	Mol. wt. computed
0.1166	0.0730	448.3	0.1130	10.15	445.6
0.1027	0.0643	448.0	0.1017	9.05	449.6
0.1297	0.0804	453.3	0.1270	11.25	452.4
0.1044	0.0647	452.6	0.1420	12.55	453.6

TABLE II  
*Separate estimations of uranium and oxalate contents*

Compound taken	U. by J. reductor		Compound taken	Oxalate by $KMnO_4$	
	Calculated	Found		Calculated	Found
0.0932	0.0492	0.0498	0.1005	0.0197	0.0201
0.1510	0.0798	0.0800	0.1058	0.0207	0.0212
0.1682	0.0889	0.0890	0.1066	0.0208	0.0212
0.1746	0.0923	0.0928	0.1477	0.0289	0.0282

Tables I and II refer to the compound obtained from two preparations and each determination being carried out in duplicate.

When the oxyoxalate was obtained in place of the oxalate  $U(C_2O_4)_2$  as described above, it was evident that the formate ion does play an important role in the mechanism of the photolysis of uranyl oxalate. Our next attempt was to obtain the oxalate by the photolysis of the

the advantage of being used in this laboratory for the separation of uranium in the pure state.

The isolation of these two compounds in the final products of the photolysis of uranyl oxalate in the presence of the formate ion, in our opinion, would be of importance in elucidating the mechanism of the photolysis and in satisfactorily explaining the varying quantum yield

TABLE III  
Mol. wt. (theoretical)—522  
Mol. formula:  $U(C_2O_4)_2 \cdot 6H_2O$

Compound taken	$U_3O_8$ found	Mol. wt. computed	Compound taken	Vol. of $N/10$ $KMnO_4$ required	Mol. wt. computed
0.1844	0.0985	523.0	0.2512	28.80	523.4
0.1353	0.0729	521.0	0.2198	24.95	528.0
0.1754	0.0944	521.5	0.1188	13.60	524.1
0.1224	0.0660	520.0	0.1073	12.20	527.7

TABLE IV  
Separate estimations of uranium and oxalate contents

Compound taken	U. by J. reductor		Compound taken	Oxalate by $KMnO_4$	
	Calculated	Found		Calculated	Found
0.1736	0.0791	0.0793	0.1673	0.0564	0.0560
0.1620	0.0738	0.0735	0.1556	0.0524	0.0522
0.1633	0.0749	0.0744	0.1150	0.0387	0.0386
0.1212	0.0553	0.0558	0.0883	0.0298	0.0299

same mixture. This was achieved by exposing the mixture to sunlight with equal volume of rectified spirit, when the desired  $U(C_2O_4)_2$  settled down as bright green precipitate. The precipitate was filtered, washed several times with rectified spirit and dried in a vacuum desiccator for 2-3 hours at the room temperature. The analysis of the compound was carried out exactly as described before except that the part by weight which would require 6 litres of  $N.KMnO_4$  solution would represent the molecular weight of the compound. The data recorded in Tables III and IV would show that the compound is  $U(C_2O_4)_2 \cdot 6H_2O$ . The preparation of the oxalate and the oxyoxalate of uranium (IV) by the method described has

which are still in the speculative stage. Further work in the line is proceeding.

1. Leighton, W. G. and Forbes, G. S., *J. Amer. Chem. Soc.*, 1930, **52**, 3139.
2. Pitzer, E. C., Gordon, N. E. and Wilson, D. A., *Ibid.*, 1936, **58**, 67.
3. McBrady, John, J., Livingston and Robert, *J. Phys. Chem.*, 1946, **50**, 176.
4. Sidgwick, N. V., *The Chemical Elements and Their Compounds*, 2nd Edition, Clarendon Press, Oxford, 1950, **2**, 1084.
5. Marchi, Louis, E., *Chem. Abstract (American)*, 1955, **49**, 5186 C.
6. Buchi, P. F., *Z. Physik. Chem.*, 1924, **111**, 262.
7. Vogel, A. I., *A Text-Book of Quantitative Inorganic Analysis*, 1951, 2nd Edition, 318.

## EIGHTH ANNUAL HIGH ENERGY PHYSICS CONFERENCE AT CERN

**T**HE Eighth High Energy Physics Conference was held this year under the auspices of CERN European Organization for Nuclear Research at Geneva from June 30 to July 5, 1958. This is the first time the Conference was held outside Rochester (U.S.A.) and the 300 and odd participants who attended by invitation represented a truly international gathering.

The Conference held nine sessions which fell into three categories: (1) Nucleon structure and interaction of nucleons with photons, pions, nucleons and anti-nucleons, (2) production and interactions of strange particles, (3) weak interactions including  $\beta$ -decay,  $\pi$ -decay and leptonic decay of strange particles. Very few individual papers were presented and instead rapporteurs were assigned for each subject whose task was to present a summary of all the papers falling under the same title submitted to the Conference. This procedure was very successful leaving ample time for discussion.

Dr. M. Goldhaber of Brookhaven presented an excellent summary on the experimental situation of weak interactions. Following the prediction and verification of non-conservation of parity in  $\beta$ -decay, experimenters have been actively engaged in this field and the summary covered the work done by over 70 workers from forty laboratories. As a result of intensive investigations it has now been established that  $\beta$ -interaction is Vector for Fermi transitions, and Axial Vector for Gamow-Teller transitions. The phase difference between V and A is  $180^\circ \pm 30^\circ$  hence interaction is  $(V - A)$ . The ratio of  $|C_{GT}|^2$  to  $|C_F|^2$  is  $(1.55 \pm .08)$ . Electron and neutrino (conventionally defined as particles) have negative helicity while positron and anti-neutrino have positive helicity (anti-particles). The results are in agreement with two-component neutrino theory. Time reversal invariance appears to be valid to an accuracy of 10%. Thus some fifty years of experimental research in  $\beta$ -decay has been brought to a conclusion. The theorists have to find answers to these observations, and in particular explain the absence of the  $\beta$ -decay of pion,  $\pi \rightarrow e + \nu$ , as also find some reason for the existence of the  $\mu$ -meson. Some speculations on these problems were presented by Feynman in which one tries to assume that the mass of the electron is all electromagnetic.

Panofsky, Drell and Chew discussed nucleon structure. A great deal of experimental work

has been done in this field in the last few years, particularly at Stanford. The results of these experiments have been analysed to determine the lower limit to the radius outside which conventional quantum electrodynamics is valid. The limit on the radius has been estimated to be  $1/\Lambda \sim 0.3 \times 10^{-13}$  cm. and  $1/\Lambda_0 \sim 0.5 \times 10^{-13}$  cm. for the photon and the electron propagators, respectively. Electron-scattering experiments of Hofstadter give for the proton charge and anomalous magnetic moment r.m.s. radii equal values of  $(0.8 \pm 0.1) \times 10^{-13}$  cm. while for the neutron, they give  $(0 \pm .006) \times 10^{-13}$  cm. for the core or charge radius and for its anomalous moment a radius  $(0.6 \pm .15) \times 10^{-13}$  cm. All the experiments are consistent with a point neutron and a spread out proton charge; this poses difficulties to theorists with regard to charge symmetry in nucleon forces.

Sternberger, Glaser and Kaplon reported on strange particles. Bubble chamber as the detector has been intensively used in the field of high energy particle physics in recent years. The cross-section for  $\Lambda$ -production is  $\pi - P$  collision has been measured from 0.91 to 1.4 BeV/c. Two cases of artificially produced  $\Xi$  have been found by Wilson-Powells' group in Berkeley indicating a 1 or 2 microbarns cross-section for 5.3 BeV.  $\pi$ -mesons. Some cases of anti-hyperon production have been reported. A number of tests of parity non-conservation in production and decay processes involving  $\Lambda^0$ ,  $\Sigma^0_{\pm}$  and  $\Sigma^0$  have been carried out by Berkeley and Columbia groups. While parity is found to be conserved in production processes, the  $\Lambda^0$ -hyperon being polarized perpendicular to the production plane, it is not conserved in decay processes. Spins of  $\Lambda$  and  $\Sigma$  are found to be  $\frac{1}{2}$  and accurate measurements of their lifetime and Q-values have been made. Cloud chamber events by the M.I.T. group show clearly the  $K_2^0 \rightarrow K_1^0$  transformation, and these are expected to give a measure of  $K_1^0$ ,  $K_2^0$  mass difference.

Preliminary results in star production on nuclear emulsion with the Russian phasotron operating with a beam of 9 BeV. protons were presented by Russian scientists.

In pion scattering, accurate measurements were reported at 91 MeV. by Liverpool, 24.8 MeV. by Rochester and 270-300 MeV. by Russian laboratories, respectively. The signs of  $a_{31}$  and  $a_{13}$  phase shifts are definitely negative. Pro-

Professor Puppi remarked that further accurate measurements were needed on ( $\pi^-$ , P) scattering in 100-150 MeV. region to test the validity of dispersion relations. Using  $\pi^+$  dispersion relations and low energy photo-production data, the pion nucleon coupling constant is found to be  $f^2 = 0.08 \pm 0.01$ , same as that given last year. Single pion photo-production measurements have been extended upto 900 MeV. photon energy at Cornell and Caltech. The  $\pi^+$  and  $\pi^0$  cross-sections show a second pronounced maximum at 700 MeV. This has been interpreted by R. R. Wilson of Cornell to indicate a resonant isobaric state with  $T = \frac{1}{2}$ ,  $J = 3/2$ . The discrepancy between  $\pi^+/\pi^-$  ratio in photo-production from  $D_2$  and the Panofsky ratio still remains, and no evidence for pseudo-scalar, isotopic spin zero  $\pi^0$ -meson, proposed by Baldin to explain this discrepancy, has been found.

Search is continuing for 500  $m_\mu$  particle, reported by Alikhanian two years ago, by six different laboratories using counter, cloud chamber and emulsion techniques. As yet no such particle has been seen in 5,000  $\mu$ -mesons. This would indicate that the frequency given by the Alikhanian experiment is too high by a factor of 20.

Theoretically very little progress was reported and certainly one is waiting for some new idea to get us out of the difficulties of divergent field theories or of the mathematical difficulties of analytic continuation of dispersion integrals. Attempts to approach the problem differently were reported by Heisenberg, A. Bohr, Schwinger and others.

Tata Institute of  
Fundamental Research,  
Bombay.

G. B. YODH.

---

## OBITUARY

### PROFESSOR K. V. GIRI

THE sudden demise of Dr. Giri on July 17, 1958, at Madras, took away from our midst a distinguished biochemist of our country.

Kramadhathi Venkata Giri was born near Madanapalle in 1907. Graduated from the St. Joseph's College, Trichinopoly, he took the M.Sc. Degree of the Calcutta University and then joined the Department of Biochemistry, Indian Institute of Science, Bangalore, in 1929. His early work on "Investigations on Enzymes" gained for him the Degree of Doctor of Science of the Calcutta University in 1938. After two years of service as Enzyme Chemist at the Nutritional Research Laboratories, Coonoor (1939-40) and three years as Gowthami Lecturer and later Reader in Biochemistry at the Andhra University, he returned to the Institute at Bangalore, to become Lecturer in Biochemistry in 1943. He was elevated in 1950 to the Professorial chair in Biochemistry, a post he held till the end. During 1949-50, he was associated with Prof. H. von. Euler, at the University of Stockholm, Sweden, and visited Norway,

Denmark and England. He presided over a section of the International Symposium on Enzyme Chemistry held at Tokyo in the fall of 1957.

Dr. Giri's main interest in research was plant biochemistry, particularly the mechanism of synthesis of oligosaccharides and starch in cereals and plants, a field to which he made several notable contributions. However, he was deeply interested in the spread of biochemical education, if only for the study of our abundant vegetable and animal resources. He held the firm conviction that to achieve this end, economical and highly simplified biochemical techniques are necessary prerequisites and he turned, in his characteristic way, his unstinted attention to the introduction of such of his modified techniques as circular paper chromatography and agar electrophoresis. He spared no pains to popularise them through his writings, lectures, radio-talks and visual demonstrations by charts and cine-films.

## LETTERS TO THE EDITOR

## FADING OF RADIO WAVES

WORKING in the Ionospheric Laboratories of the Physics Department of Sri Venkateswara University, Tirupati, the problem of the fading of radio waves was studied, choosing medium wave radio transmissions from Madras (distance = 110 Km.), Tiruchirapalli (distance = 320 Km.) and Delhi (distance = 1,700 Km.). Observations were taken employing a specially designed sensitive R-F amplifier-detector unit. The voltage developed across a resistor placed in the anode circuit of the detector is fed to a sensitive, low period mirror galvanometer. The deflections of the galvanometer are then proportional to the amplitude of the down-coming wave. Galvanometer deflections were noted at intervals of every three seconds for a period of 10 minutes at different times between 19.00 and 23.00 hrs. every day. The variations of galvanometer deflections with time were represented graphically. From such graphs the amplitude

distribution curves were drawn in the usual way<sup>1</sup> for the three stations mentioned above. Following Khastagir and Ray<sup>2</sup> the Rayleigh formula was employed to draw the theoretical distribution curves. The probability  $P(r)dr$  of the amplitude lying between  $r$  and  $(r + dr)$  is given by

$$P(r) dr = \frac{r}{r_m^2} \exp\left(-\frac{r}{r_m}\right) dr,$$

where  $r_m$  is the most probable amplitude as found from the time-intensity graphs. The three theoretical and experimental curves for the three stations are shown in Fig. 1.

From the figure it is clear that there is a very close agreement between the experimental curves and theoretical distributions for the two near stations (Madras and Tiruchirapalli). This confirms the earlier findings of Pawsey<sup>1</sup> and Khastagir and Ray.<sup>2</sup> For the distant station (Delhi) the experimental curve shows two maxima indicating considerable departure from theoretical expectations. These deviations are being studied and details will be published in due course.

The authors record their sincere thanks to Dr. J. Bhimasenachar, Reader in Physics, for his encouragement and the interest he has been taking in this work.

Physics Department,  
Sri Venkateswara

P. VENKATESWARLU.  
R. SATYANARAYANA.

University,  
Tirupati, April 10, 1958.

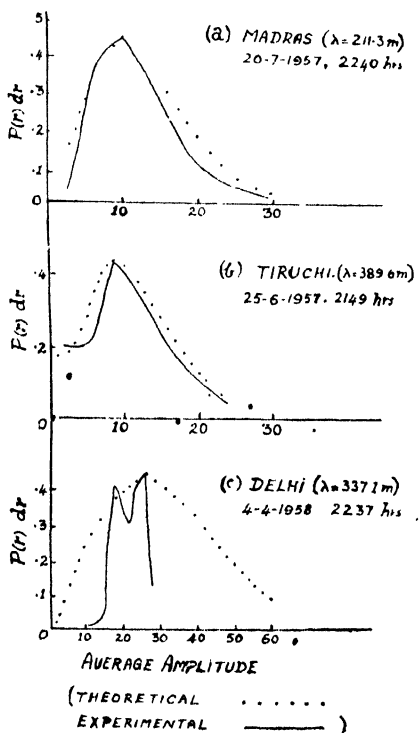

FIG. 1. Amplitude distribution curves.

1. Pawsey, J. L., *Proc. Camb. Phil. Soc.*, 1935, **31**, 125.
2. Khastagir, S. R. and Ray, A. K., *Ind. Jour. Phys.*, 1940, **14**, 283.

#### MAGNETISM AND MOLECULAR STRUCTURE: PROXIMITY EFFECT IN ORTHO-SUBSTITUTED BENZOIC ACIDS

FLÜRSCHHEIM<sup>1</sup> first pointed out that all ortho-substituents, even electropositive methyl group, increased the strength of benzoic acid. It has been observed by a number of workers that the properties of substituents attached to the benzene ring are anomalously influenced by ortho-substitution. According to Baddeley<sup>2</sup> many anomalies associated with ortho-substituents can be explained on the basis of steric

hindrance of resonance. Dippy and co-workers<sup>3</sup> have discussed the ortho effect in relation to the strengths of substituted benzoic acids. In the present investigation molar diamagnetic susceptibilities of a few ortho-substituted benzoic acids were measured to see whether it would help to understand the nature of the ortho or the proximity effect.

The apparatus and the method of measurement of magnetic susceptibilities were the same as those described by Angus and co-workers.<sup>4</sup> The results are presented in Table I. All the susceptibility values are expressed in terms of  $-1 \times 10^{-6}$  c.g.s. units. The error of measurement of specific susceptibility ( $\chi$ ) was in no case greater than  $\pm 0.001$ .

TABLE I

Compound	$\chi$	$\chi_M$	$(\chi_{COOH} - \chi_H)$
O-nitrobenzoic acid ..	0.440	73.53	11.72
Nitrobenzene ..	..	61.81 <sup>5</sup>	..
O-chlorobenzoic acid ..	0.534 <sup>6</sup>	83.56	12.56
Chlorobenzene ..	..	71.00 <sup>6</sup>	..
O-aminobenzoic acid ..	0.563	77.18	14.81
Aniline ..	..	62.37 <sup>5</sup>	..
O-hydroxy benzoic acid	0.546	75.41	14.51
Phenol ..	..	60.90 <sup>6</sup>	..
O-toluic acid ..	0.594	80.83	15.00
Toluene ..	..	65.83 <sup>7</sup>	..
Phthalic acid ..	0.496	82.39	12.12
Benzoic acid ..	0.576	70.27	15.51
Benzene ..	0.702	54.76	..

Considering that the magnitude of values of  $(\chi_{COOH} - \chi_H)$  in substituted benzoic acids will be influenced by the presence of the ortho-substituents, the extent of departure of this value from that obtained for benzoic acid may be taken as a measure of this influence. Values of  $(\chi_{COOH} - \chi_H)$  were obtained by subtracting molar susceptibility of the appropriate mono-substituted benzene derivative from that of the substituted benzoic acid. These are given in column 4 of Table I. The data on molar susceptibilities of mono-substituted derivatives of benzene required for the purpose were taken from the literature.

The diminishing order of the influence of the groups  $NO_2 > COOH > Cl > OH > NH_2 > CH_3$  is in agreement with the decreasing order of their electronegativities or the inductive effect. This observation suggests that inductive effect is of greater importance than the resonance effect while considering the effects of substituents at short range. It is likely that this may be due to steric inhibition of resonance brought about by destruction of coplanarity. Some kind of suppression of the resonance effect is also

indicated by the fact that contrary to expectation electron-releasing groups like the methyl group which according to Pauling<sup>7</sup> owe their electron-releasing property to the predominance of the resonance effect over the inductive effect, cause a decrease in the value of  $(\chi_{COOH} - \chi_H)$  in the same manner as a strongly electron-attracting group like the nitro-group.

On the basis of the Langevin expression for molar diamagnetic susceptibility, the observed reduction in the value of  $(\chi_{COOH} - \chi_H)$  on introducing an ortho-substituent group in unsubstituted benzoic acid may be attributed to a decrease in electron density around the carboxyl group resulting from the withdrawal of electrons by the ortho-substituents through the inductive mechanism. This is borne out by the fact that the  $(\chi_{COOH} - \chi_H)$  value decreases with an increase in the electronegativities of the ortho-substituents. It may be concluded, therefore, that the existence of the ortho or the proximity effect which was discovered while studying esterification of benzoic acids and their dissociation constants, is also supported by the diamagnetic behaviour of ortho-substituted benzoic acids.

The work described in this article was carried out by the author during the tenure of a Government of India scholarship at the University College of North Wales under the direction of Dr. W. R. Angus.

Chemistry Department, D. D. KHANOLKAR,  
Institute of Science,  
Bombay-1, April 1, 1958.

1. Flürscheim, *J. Chem. Soc.*, 1909, **95**, 722.
2. Beddeley, *Nature*, 1939, **144**, 444.
3. Dippy and co-workers, *Chem. Rev.*, 1939, **25**, 151.
4. Angus and co-workers, *Trans. Faraday Soc.*, 1943, **39**, 185; 1947, **43**, 235.
5. Baddar and Sugden, *J. Chem. Soc.*, 1950, 308.
6. French, *Trans. Faraday Soc.*, 1945, **41**, 676.
7. Pauling, *The Nature of the Chemical Bond*, Oxford University Press, 2nd Edition, 1952, p. 150.

#### A METHOD OF ELECTROLYTIC ETCHING OF TANTALUM FOR CAPACITOR USE

THE idea of using tantalum for electrolytic capacitors is not new, but the greatest developments in this field have occurred only recently. Although tantalum is much more costly than aluminium, the dielectric constant of its anodic layer is also about 50% higher than that of aluminium. Further economies can be effected by evolving a suitable etching technique which would increase the surface and thereby the



capacitance. Various attempts, mostly under patents, had been made to evolve a satisfactory technique of etching tantalum but due to its marked inert nature and resistance to corrosion none had been completely successful in finding a simple technique. It is attacked only by concentrated boiling caustic alkalies or by hydro-fluoric acid but both these treatments often embrittle the tantalum foil or wire. A fresh attempt was, therefore, made.

Some initial experiments were made for evolving a suitable electrolytic etching method. Use of organo-halogen compounds was considered most hopeful due to the powerful action of the nascent halogen atoms produced *in situ* during the electrolysis. Various combinations and baths such as aqueous and non-aqueous solutions of bromo-acetic acid, bromine, chlorine, etc., were tried and although under suitable electrolytic conditions, a certain amount of etching could be observed, the results were never very satisfactory as either the magnification was very low or the etch pattern was very irregular and concentrated on some weak points leading to small holes in the foil. However, the use of trichloroacetic acid and methanol as the basic components of the bath gave better results. Another necessary requirement about the bath being insensitive to the presence of small quantities of water and not requiring special purification of the components was also fulfilled. With the use of trichloroacetic acid, it was found that technical methanol could be easily used and that the presence of 0-10% water did not tremendously change the effectiveness of the treatment. However, it was found that even a 5% solution of trichloroacetic acid in methanol did not pass much current during the initial stages of the electrolysis although the bath resistance gradually decreased and the current increased as the etching progressed. In order to avoid this, a small amount of sodium hydroxide was added, forming sodium trichloroacetate *in situ* in the solution. This considerably improved the conductivity of the solution. Satisfactory etching could be obtained in 3-30 minutes in such a bath at a current density of 20-70 mA/cm.<sup>2</sup> of the tantalum foil, the actual values of current density and time depending on the bath composition, the type of etch required and the thickness of tantalum foil used. The temperature used was usually between 20-40° C. Tantalum anodes thus etched showed a regular etch pattern, increasing the surface by as much as 500% or so. Such anodes were then anodised and formed in suitable glyco-borate baths, and assembled when their capaci-

ties showed an effective increase of 300-400%, depending upon the voltage of forming. For example, a tantalum foil, 50  $\mu$  thick, when etched for 15 minutes at 40 mA/cm.<sup>2</sup> and 35° C. in a bath consisting of trichloroacetic acid 5 g., sodium trichloroacetate 1 g. and methanol 100 g. and later formed to 65 V, showed a capacity magnification of 3.8 times over a similar unetched foil. Similarly, as high a capacity rating as 1 Mfd./cm. could be achieved by etching a 1 mm. diameter tantalum wire and forming at 12 V.

A British patent is being obtained and the author has assigned the world rights for the exploitation of this invention to Messrs. British Dielectric Research Limited, London.

April 11, 1958.

INDRA SANGHI.\*

\* Present Address: Senior Scientific Officer, Central Electrochemical Research Institute, Karaikudi.

#### PHOTOCHEMICAL PROPERTIES OF NICKEL COMPOUNDS

WHILE nickel compounds are not known to exhibit any marked photochemical properties comparable to compounds of iron, records of a few observations of such activity are to be found in literature. For example, Plotnikov<sup>1</sup> reported that the green surface of nickel hydroxide darkened on exposure to light. Baly and co-workers<sup>2</sup> noticed that the green surface of nickel carbonate turned black on prolonged exposure to sunlight. These workers did not, however, attempt to find out the nature of the chemical change involved in this darkening. In the course of a systematic study of the action of sunlight and light from mercury arc, on solutions of nickel nitrate, the present author found that this compound decomposes yielding nickel nitrite, some oxygen and a black solid corresponding to Ni<sub>2</sub>O<sub>3</sub>. The course of the reaction was followed by estimating the nitrite content of the exposed solutions. The photolysis of nickel nitrate, therefore, resembles the photolysis of alkali nitrates,<sup>3</sup> chlorates<sup>4</sup> or perchlorates,<sup>5</sup> which form lower compounds and evolve oxygen. It was further observed that the addition of an acid like acetic acid retarded while addition of some sodium hydroxide accelerated photolysis. Besides, green nickelous oxide formed by the addition of sodium hydroxide to nickel nitrate turned black quickly on exposure to sunlight, or ultraviolet light.

Exposure of nickel hydroxide and nickel carbonate precipitated from solutions of sulphate or chloride, in fact from solutions other than nitrate, chlorate or perchlorate, did not

turn dark on exposure to sunlight. Such precipitates on being mixed with small quantities of nitrate, chlorate or perchlorate, however, turned dark by photo action. It is significant that Baly's experiments were conducted with nickel carbonate precipitated from nickel nitrate. It would thus appear that the darkening of the solids observed by the previous workers was due to the presence of traces of nitrate adhering to the solid particles.

The photolysis of nitrate ion to yield nitrite ion and atomic oxygen, and the combination of atomic oxygen with nickelous oxide to yield nickelic oxide would be the explanation of the phenomena observed in the cases cited.

The full details of this work will be given in a later communication.

The work described in this paper was carried out by the author in the Chemistry Department of Osmania University in 1946, under the guidance of late Dr. M. Qureshi, and formed part of the thesis submitted for the Ph.D. Degree of the University.

Photochemical Laboratory, K. VEERIAH.  
Cambridge Research Centre,  
Boston, Massachusetts,  
U.S.A., April 7, 1958.

1. Plontonikov, 'Allgemeine Photochemie,' *Zweite Auflage*, 1936, 427.
2. Baly and co workers, *Photosynthesis*, 1940, 96.
3. Warburg, *Sitzb. Preuss. Akad. Wiss.*, 1918, 1228.
4. Dhar and Sanyal, *J. Phys. Chem.*, 1925, **29**, 926.
5. Mathews and Curtis, *Ibid.*, 1914, **18**, 641.

#### DOUBLE BOND REACTIVITY OF UNSATURATED FATTY ACIDS IN MINERAL FLOTATION

SOAP flotation of non-sulphide minerals has been the subject of study by many workers and the present work is an attempt to find the relative collecting power of some unsaturated fatty acids for the flotation of calcite. The effect of the flotation variables such as the nature of the collector, concentration of the collector and the pH of the medium, on the contact angle of calcite was studied with a view to correlate the collecting power of fatty acids with their degree of unsaturation. The apparatus used for the measurement of contact angles was similar to those employed by Taggart, Taylor and Ince<sup>1</sup> and del Giudice,<sup>2</sup> with some modifications for easier working. Contact angle measurements were made on highly polished calcite crystals (99.7% CaCO<sub>3</sub>) collected from a mine near Bhadravati, Mysore State.

Stearic acid, a saturated 18 carbon fatty acid

and three unsaturated 18 carbon fatty acids, namely, oleic, linoleic and linolenic acids containing respectively one, two and three double-bonds in their molecule, were used as collectors, in the form of solutions of their sodium soaps. With each collector, in the concentration range of 5-500 mg. per litre, contact angle was found to increase with increase in concentration, up to a maximum equilibrium value of 60° and thereafter it remained constant. In dilute solutions (5-150 mg. per litre), for the same concentration, linoleic acid gave a larger contact angle than oleic acid and hence the minimum concentration of collector required to give the equilibrium contact angle of 60° was less in the case of linoleic acid than with oleic acid. Linolenic acid gave the same contact angle as linoleic acid. Stearic acid was found to be a poor collector for calcite, inasmuch as it was very difficult to get it adsorbed on the mineral surface to produce a definite contact angle. Hence unsaturated fatty acids are better collectors than saturated ones. Linolenic acid, though having one more double-bond than linoleic acid did not give a higher contact angle than linoleic acid of the same concentration. Hence, as a collector, linolenic acid behaves just like linoleic acid and is in no way better.

Contact angle was found to increase with time until the final equilibrium value was reached. Equilibrium angle was obtained sooner or later depending upon the pH of the collector medium. Hence with a particular collector concentration sufficient to give the maximum contact angle of 60°, the time of attainment of equilibrium was determined at various pH values. This time was found to increase with increase in the pH of the collector. Under identical conditions of collector concentration, pH and temperature, equilibrium was attained quicker in the case of linoleic acid than with oleic acid, the difference being pronounced at higher pH values. In this respect, the behaviour of linolenic acid was the same as that of linoleic acid. Hukki and Vartiainen<sup>3</sup> by vacuumatic cylinder flotation tests on ilmenite, have made certain observations and concluded that the collecting power of fatty acids used in flotation increases with increasing unsaturation of the hydrocarbon chain. This conclusion, however, is not supported by their tests with linolenic acid and this has been attributed to the fact that the linolenic acid used by them was only a 65% concentrate. In the present investigation, a concentrate containing 85% linolenic acid, the rest being mostly

linoleic acid, has been used. Taking into account the percentage purity of the linolenic acid sample used, the collecting power of a solution of pure linoleic acid (sodium soap) was compared with that of a solution of this linolenic acid but of a higher concentration so that the two solutions contained the same number of molecules of linoleic and linolenic acids respectively. Still the collecting action was the same in both the cases. •

Recently Sun and others<sup>1</sup> in an investigation on the flotation characteristics of a leached zone aluminiferous phosphate ore, have observed that the collecting power of fatty acids increases with increase in unsaturation of the collector molecule, up to two double bonds only and further increase in the number of double-bonds has no effect. The results of the present investigation lead to the same conclusions as those of Sun and others.

#### ACKNOWLEDGEMENT

The authors are very thankful to Prof. A. A. Krishnan, Head of the Department of Metallurgy, Indian Institute of Science, for his keen interest in this investigation.

Dept. of Metallurgy, R. MALLIKARJUNAN,  
Indian Inst. of Science, V. RAMACHANDRAN,  
Bangalore, April 3, 1958.

1. Taggart, Taylor and Ince, *Amer. Inst. Mining Met. Engrs., Tech. Pub.*, **204**, 1929.
2. del Giudice, *Eng. Mining J.*, 1936, **137**, 291.
3. Hukki and Vartiainen, *Mining Engrs.*, 1953, **5**, 818.
4. Sun *et al.*, *Ibid.*, 1957, **9**, 70.

### GEOLOGY OF ADIKMET AREA, HYDERABAD

PRELIMINARY investigations of the Adikmet area indicate that there are two distinct varieties of granites, showing differences in colour, mineral composition, texture and degree of deformation. Megascopically these can be classified into the pink and the gray granites. Considerable variation in grain-size is noticed in both the granites. Pink granites are mostly coarse and porphyritic while among the gray granites the darker rocks are medium- to fine-grained and the paler rocks are coarse and porphyritic. The darker rocks are gneissose in appearance. Small pegmatitic and aplitic veins are numerous. A few basic dykes intrude into these granites. Dark basic inclusions (probably xenoliths) are found both in the pink and the gray types but appear to be more abundant in the gray granites. The distribution of the granites

along with later intrusives is shown in the map (Fig. 1).

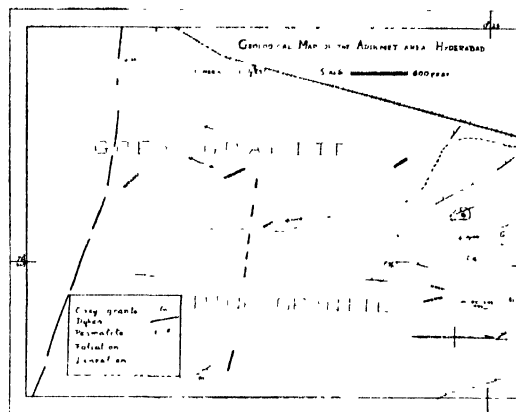

FIG. 1

The boundary between the pink and the gray granites is not very distinct. A few gradational contacts and still fewer sharp contacts have however been observed. At places an intermixture of the two (probably a hybrid type) is seen.

Some of the prominent structural features studied in the area are shown in Fig. 1. A critical study of joint pattern shows that major joints strike in east-west direction. A study of the elasticity and petrofabrics reveals that the gray granites are more deformed than the pink variety. It is interesting to note that the lineation and foliation directions are more or less parallel to the trend of the outcrops.

Further critical studies will be carried out of the larger area in order to bring out the tectonic history of the region.

Osmania University, DR. S. BALAKRISHNA,  
Hyderabad, PROF. PETER E. WOLFE,  
April 4, 1958. N. RAJA.

### EFFECT OF BLANCHING ON ENZYMIC BROWNING IN GREEN AMARI APPLE

ENZYMIC browning in fruits and vegetables has been studied by numerous workers and has been reviewed by Joslyn and Ponting.<sup>1</sup> In the case of apples of the Green Amari variety, which are used in this country for making preserve, it was of interest to study the rate of destruction of the browning enzymes during blanching prior to treatment with sugar syrup. Apples of this variety were peeled, placed in 2% salt solution and then blanched in boiling water for

2-15 minutes, cooled quickly in cold water and examined for any browning. On cutting the apple into halves either transversely or longitudinally, it was observed that there was a circular crescent-like brown ring demarcating the fruit tissue into two sections in the case of blanching upto 6 minutes, and the area of the brown surface around the pit of the apple decreased with increase in the duration of blanching in the case of 7, 8 and 10 minutes blanch. There was, however, no ring or brown centre in the case of the 15-minutes' blanch thereby indicating complete destruction of the browning enzymes (Fig. 1).

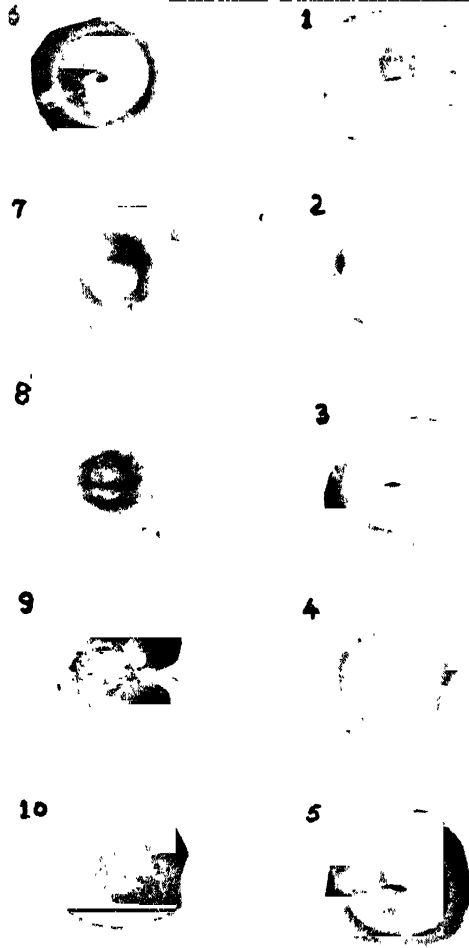

FIG. 1

FIG. 1. Progress of brown ring formation with blanching time in Green Amari apple. Numbers 1-10 represent blanching period of 0, 2, 3, 4, 5, 6, 7, 8, 10 and 15 mins.

In another set of experiments, where peeled whole apple and quarter slices cut transversely, were blanched for 10 minutes, it was observed

that while the slices had not turned brown at all, the whole apple had a markedly brown centre (Fig. 2). There was no further change

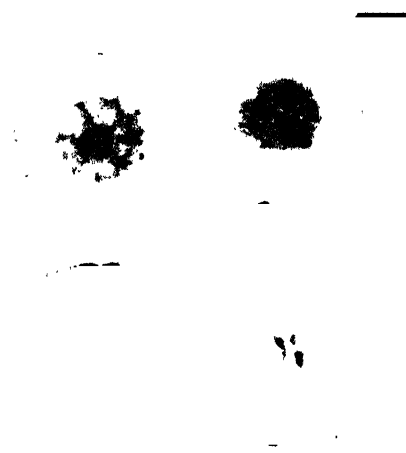

FIG. 2. Browning in whole apple and in cut slices (Blanching time 10 mins.). Top: Slices cut from blanched whole apple; Bottom: Blanched slices.

in the position or area of the brown surfaces in the different sets of blanched apples when they were kept for 12 hours at room temperature of 24-30° C., indicating thereby destruction of enzyme activity. The enzyme is destroyed gradually from the outer periphery towards the centre of the apple with increasing blanching time. The intense browning inside the whole apple may be attributed to the increased and prolonged activity of the enzymes in the partially injured tissue in that region as a result of mild heating, which has been sufficient to injure the cells, but not to inactivate the enzyme system. In the case of the cut slices, however, the heat transfer being over a comparatively much larger area, the enzyme system is quickly inactivated. In the case of peaches, Cruess, Quin and Mrak<sup>2</sup> have stressed the importance of completely heating the fruit to inactivate the enzymes in the interior. Joslyn and Hohl<sup>3</sup> have observed that in scalded fruit browning will occur in the unheated or partially heated areas.

As regards varietal differences, the browning reaction is most marked in Green Amari apple and faint in Golden Delicious, Lal Amari and Kesari varieties. Adequate blanching is essential to prevent any discolouration in sections of the fruit in the final apple preserve.

ACKNOWLEDGEMENT

The authors are grateful to Dr. V. Subrahmanyam, Director, and Dr. Girdhari Lal,

Assistant Director, for their keen interest in this work.

Central Food Tech.                      G. S. SIDDAPPA.  
Research Institute,                      B. S. BHATIA.  
Mysore, April 19, 1958.

1. Joslyn, M. A. and Ponting, J. D., *Enzyme Catalyzed Oxidative Browning of Fruit Products*, *Advances in Food Research*, Academic Press, Inc., Publishers, New York, 1951, **3**, 1-37.
2. Cruess, W. V., Quin, J. P. and Mark, E. M., *Fruit Products J.*, 1932, **12**, 38-40.
3. Joslyn, M. A. and Hohl, L. A., *Calif. Agr. Expt. Sta. Bull.*, 1948, **703**, 1-108; Seen in *Advances in Food Research*, 1951, **3**, 29-30.

### MOSAIC DISEASE OF BRINJAL : A CORRECTION

RAYCHAUDHURI described a mosaic disease of *brinjal* (*Solanum melongena* Linn.) of widespread occurrence at Delhi and transmissible through grafts and by *Empoasca devastans* Dist.<sup>1</sup> The symptoms described are no doubt of very common occurrence on *Brinjal* at Poona during winter and *Empoasca devastans* is also found in abundance on these plants. But in carefully planned tests in the glass-house at Poona, large population of the jassid liberated on healthy *brinjal* seedlings according to the methods described by Raychaudhuri<sup>1</sup> failed to transmit the disease to any of the 21 plants inoculated nor was the disease transmitted to tomato. Since *E. devastans* has not been reported to be a vector of any plant virus disease, Raychaudhuri's<sup>1</sup> findings aroused a doubt about *E. devastans* being a vector of *brinjal* mosaic. The transmission of *brinjal* mosaic disease by *E. devastans* was, therefore, reinvestigated both at Poona and Delhi.

A *brinjal* plant showing typical symptoms of the disease was brought from Delhi to Poona and used for inoculating healthy *brinjal* seedlings through *Empoasca devastans* from colonies of the jassid<sup>1</sup> on American cotton and *brinjal* plants. The insects were fed on the source of inoculum for 24 to 72 hours and liberated on healthy test plants for several days. The test plants were afterwards sprayed with Folidol at weekly intervals to prevent building up of jassid populations through the hatching of eggs. The number of jassids liberated on each test plant varied from 20 to 50. Fifty plants were tested in this manner but the disease was not transmitted to any of them. Similar attempts to transmit the disease from mosaic affected *brinjal* plant to healthy *brinjal* seed-

lings through *Empoasca devastans* at Delhi also proved unsuccessful.

These results clearly indicate that the disease described by Raychaudhuri<sup>1</sup> is not transmitted by *Empoasca devastans*.

The note is being published to prevent continued mention in literature of *Empoasca devastans* as a vector of mosaic disease of *brinjal*.

The authors are indebted to Dr. R. S. Vasudeva for suggesting this item of work and for critical scrutiny of the tests.

Division of Mycology &                      P. M. VARMA.  
Plant Pathology,                              T. K. NARIANI.  
Indian Agric. Res. Inst.,  
New Delhi, January 18, 1958.

1. Raychaudhuri, S. P., *Curr. Sci.*, 1947, **16**, 149-50.

### A NOTE ON THE ORGANIC PRODUCTION IN THE INSHORE WATERS OF THE GULF OF MANNAR\*

ALTHOUGH considerable data are available on the standing crop of plankton, practically no information is available on the daily production of organic matter in our waters and therefore investigations were started in 1957, with a view to measuring the magnitude of production of organic matter by the plankton algae and its fluctuations. Productivity has been defined by Wood<sup>1</sup> as "light energy transformed by photosynthesis into energy-containing plant material, and this rendered available for further biological use". The technique employed in the present investigation for measuring the primary production is the well-known dark- and clear-bottle experiments. The authors are fully aware of the limitations of this technique but due to lack of facilities for employing the much more sensitive method of using <sup>14</sup>C and also due to the fact that the investigations are conducted in an area where the depth does not exceed 6 metres, the present technique was employed. After a series of preliminary trials the duration of the experiment was fixed at 48 hours and routine measurements were made once a week.

Based on the data available from the experiments conducted so far, the production of organic matter in this area has been calculated and it is found to vary from 0.335 to 1.216 g. C./m.<sup>3</sup> per day. The rate of production appears to be high but it does not seem to be unusual for such areas as the present one because Steemann Nielson and Jensen<sup>2</sup> found during the *Galathea*

TABLE I

Locality	Production	Method employed	Author
Bay of Bengal	0.12 to 0.24 g. C./m. <sup>2</sup> /day	<sup>14</sup> C technique	Steemann Nielsen and Jensen <sup>2</sup>
10 stations in the shallow depth in the Indo-Malayan waters	0.24 to 1.08 g. C./m. <sup>2</sup> /day	do.	do.
Equatorial part of Indian Ocean (Mombasa to Ceylon)	0.13 to 0.47 g. C./m. <sup>2</sup> /day	do.	do.
Sargasso Sea	0.03 g. C./m. <sup>3</sup> /day	O <sub>2</sub> technique	Riley <sup>3</sup>
do.	0.00017 g. C./m. <sup>3</sup> /day (0.043 to 0.058 g. C./m. <sup>2</sup> /day)	<sup>14</sup> C technique	Steemann Nielsen <sup>4</sup>
Long Island Sound	0.04 to 0.25 g. C./m. <sup>3</sup> /day	O <sub>2</sub> technique	Riley <sup>5</sup>
Georges Bank	0.014 to 0.395 g. C./m. <sup>3</sup> /day	do.	do.

Expedition that the rate of organic production anywhere in the tropics in shallow waters is practically high. For comparison the rate of production of organic matter recorded by some of the earlier workers for a few selected areas is given in Table I. The available data further indicate that in the area under investigation, production is usually higher at the lower temperature and salinity ranges.

Concurrent with these experiments, studies are also being made of the standing crop of phytoplankton in terms of chlorophyll, rate of production of diatoms, standing crop of zooplankton and its relation to primary production, rate of grazing, total organic nitrogen and protein nitrogen of the standing crop of plankton. The detailed results of these investigations will be published in due course.

The authors wish to thank Dr. N. K. Panikkar and Dr. S. Jones for encouragement and criticisms.

R. RAGHU PRASAD.  
V. KRISHNA PILLAI.  
P. V. RAMACHANDRAN NAIR.

Central Marine Fisheries  
Research Station,  
Mandapam Camp, April 8, 1958.

\* Published with the permission of the Chief Research Officer, Central Marine Fisheries Research Station, Mandapam Camp, South India.

1. Wood, F. J. F., *Journ. du Cons.*, 1956, **21**, 280-83.
2. Steemann Nielsen, E. and Jensen, E. A., *Galathea Rept.*, 1957, **1**, 49-136.
3. Riley, G. A., *Jour. Mar. Res.*, 1939, **2**, 145-62.
4. Steemann Nielsen, E., *Jour. du Cons.*, 1954, **19**, 309-28.
5. Riley, G. A., *Bull. Bingham Ocean. Coll.*, 1941, **7**, 1-93.

### THE KINETOCHORE PROBLEM IN HEMIPTERA

EXAMINATION of the chromosomes of *Orycaenus* sp. (Hemiptera: Heteroptera: Lygaeidae) shows that the kinetochore is localized in this form. Earlier accounts (Menon<sup>1</sup>) of the cytology of this genus mention 17 as the diploid chromosome number in the male, with X<sub>1</sub>X<sub>2</sub>Y sex chromosome mechanism. My observations agree with those of Menon regarding the chromosome number (Fig. 1) as also the occa-

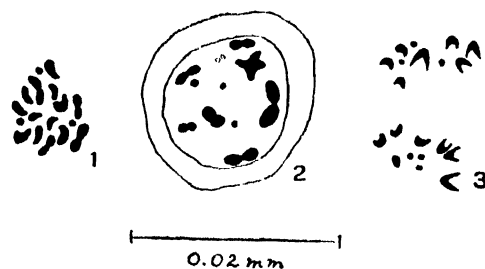

FIG. 1. Spermatogonial metaphase showing 17 chromosomes. Most of them show a primary constriction. The three dot-like bodies represent X<sub>1</sub>X<sub>2</sub>Y.

FIG. 2. Nucleus in Diakinesis showing two *m*-chromosomes (shown in outline). The three dot-like bodies represent X<sub>1</sub>X<sub>2</sub>Y.

FIG. 3. Anaphase I with the characteristic 'V'-shaped chromosomes seen clearly.

sional presence of two *m*-chromosomes (Fig. 2). But since no information is available in regard to the kinetochore, the present finding of localized kinetochore in the chromosomes of *Orycaenus* is of special interest.

Spermatogonial chromosomes at metaphase show a distinct primary constriction. In anaphase I also this is noticed, especially clearly in the largest chromosomes which are meta-centric (Fig. 3).

Localized kinetochores have been reported in a few other Hemiptera (Pyrrhocoridae: Mendes<sup>2</sup>; Pentatomidae: Dutt<sup>3</sup>; Eurybrachidae: Rao<sup>4</sup>) but this is the first report on a Lygaeid. In view of Piza's<sup>5</sup> observations that the Hemipteran chromosome is dicentric, and the concept of "diffuse centromere" developed by Schrader,<sup>6</sup> Hughes-Schrader<sup>7</sup> and Hughes-Schrader and Ris<sup>8</sup> in this order, it seems possible that more than one condition of the kinetochore exists in this versatile group.

My thanks are due to Prof. B. R. Seshachar for his criticism and encouragement.

Dept. of Zoology, S. R. VENKATASUBBA RAO.  
Central College, (N.I.S. Junior Research Fellow)  
Bangalore, March 25, 1958.

1. Menon, P. S., *Experientia*, 1955, **11**, 483.
2. Mendes, L. O. T., *Bragantia*, 1949, **9**, 53.
3. Dutt, M. K., *Experientia*, 1955, **11**, 233.
4. Rao, S. R. V., *Gentua Iberica*, 1957, **9**, 283.
5. Piza, S., *An. Fac. Sup. Agr.*, "Luz de Queiroz," 1953, **10**, 156.
6. Schrader, F., *Cytologia*, 1935, **6**, 422.
7. Hughes-Schrader, S., *Adv. Genet.*, 1948, **2**, 127.
8. — and Ris, H., *J. Exp. Zool.*, 1941, **87**, 429.

#### STEM-CANKER, A SCLEROTIAL DISEASE OF HOLLYHOCK (*ALTHAEA ROSEA* CAV.) FROM INDIA

A DISEASE of hollyhock, in which the shoot withered from the apex, was observed in some plants of the Departmental Garden in the first week of January 1951, after a first shower of winter rains. In a number of cases the occurrence of the isolated dried regions in the affected plants was also noted. As the disease spread, nearly 12% of the plants were affected (Fig 1). On survey the disease was also noticed in several plants growing in other gardens of Lucknow. A number of isolations made from the diseased plants indicated that a strain of *Sclerotinia sclerotiorum* (Lib) de Bary is associated with the disease, which has only been recorded earlier from America. However, this is a new record for India.

The general symptoms of the disease as observed here agree in main with those described by Young.<sup>1</sup> The epidermis of the dried region shows general browning with some scattered pinkish brown, nearly concentric rings of irregular margins (Fig. 2). The small isolated and raised white pimple-like structures consisting of hyphal tangle and the epidermal cells are developed on the upper layer. The dried parts of the plant, when broken, always separated into fibres. The black rounded or

slender and elongate sclerotia (ranging from 1 or 2 mm to about  $\frac{3}{4}$ " in length) were abundantly found associated with profuse white fluffy mycelium in the central pith cavity of the affected stem which develops due to the decomposition of the pith cells (Fig. 3). The



FIGS. 1-3. Fig 1. Healthy and diseased plants. Fig. 2. Cankered area showing irregular concentric zonation.  $\times 4$ . Fig. 3. Sclerotia in the pith cavity,  $\times 4$ . region of the pith, in some cases, may also show distinct chambers. The formation of the sclerotia above the epidermis of the cankered region, a feature recorded by Young,<sup>1</sup> has, however, not been observed here even in the advanced stages of the diseased specimens.

The disease appears in 2½-3 months-old plants and occurs isolated rather than in an epidemic form. With the advance of the disease, the leaves, flowers, twigs, and ultimately the entire shoot dries up characteristically. The disease does not manifest itself at the base of the shoot. In those cases where the infection starts in the middle of the plants, the portion above the cankered region dries up after a few days. The roots do not show any disease symptom even in the heavily diseased hollyhock plants.

Forty-five % infection has been achieved, when 3-months-old hollyhock plants specially raised for the purpose in the pots, were experimentally inoculated by putting the blocks of agar bearing the pathogen in the wounds on the stem after proper surface sterilisation and covering it by a piece of cotton wool, periodically moistened with sterile distilled-water for

a few days in the beginning to avoid drying of the inoculum.

The author is thankful to Prof. S. N. Das-Gupta, for kindly suggesting the problem to investigate and critically going through the paper.

Botany Department, B. B. SHARMA.  
Lucknow University.  
Lucknow, February 22, 1958.

I. Young Paul, A., *Phytopathology*, 1934, 24, 538-43.

### VARIATION IN THE PROVENTRICULAR STRUCTURE IN THE COCKROACH *PERIPLANETA AMERICANA* (LINN.)

THE proventriculus of the Blattidæ is normally short and divisible into a 'proventriculus anterior' armed internally with chitinous plates and a 'proventriculus posterior' containing a circle of six soft, cushion-like lobes with spines and hairs directed backwards. Snodgrass<sup>1</sup> has given a brief description of the proventriculus of the cockroach. Sanford<sup>2</sup> and Eidmann<sup>3</sup> have given detailed account of the proventriculus of Blattidæ.

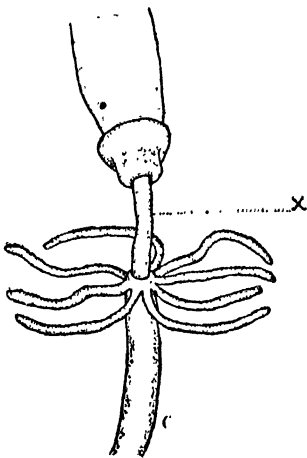

FIG. 1

X indicates the elongated part of proventriculus in the figure. Magnification,  $\times 5$ .

In a fairly appreciable number of specimens of *Periplaneta americana* examined by me, the length of the proventriculus showed considerable variation attaining a length of about 10 mm. in some specimens. This elongation is entirely in the 'proventriculus posterior', i.e., between the 'proventriculus anterior' and the



FIG. 2

oesophageal invagination or the so-called stomodæal valve. Transverse sections of the elongated portion show the presence of the circle of cushion-like lobes throughout the entire length.

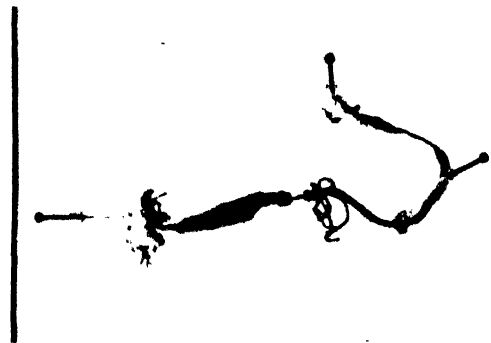

FIG. 3

The proventriculus shows all degrees of development in the various orders and families of insects, but the variation recorded in the present note is interesting as it is confined to a single species. My thanks are due to Prof. R. V. Seshaiya for his help in the preparation of this note.

Dept. of Zoology,  
Annamalai University,  
Annamalainagar,  
April 7, 1958.

N. P. KALYANAM.

1. Snodgrass, R. E., *Principles of Insect Morphology*, 1935, McGraw-Hill Book Company, New York.
2. Sanford, E. W., *Jour. Exp. Zool.*, 1918, 25, 355-411.
3. Eidmann, H., *Zool. Anz.*, 1925, 62, 49-54.



### DEVELOPMENT OF BHC RESISTANCE IN *MUSCA NEBULO* UNDER FIELD CONDITIONS

THERE is no record relating to the development of insecticide resistance in the Indian housefly, *Musca nebulosa* under field conditions. As pointed out by Pal *et al.*,<sup>2</sup> this may be due to the fact that DDT spraying is usually carried out during the malaria transmission season which does not last for more than 3-6 months, so that if some resistance is developed in this period, it is lost during the rest of the year. Abedi<sup>1</sup> also failed to find any insecticide resistance in flies collected from various localities which had been previously sprayed with DDT for fly control.

A few months back, the authors were informed by public health authorities that flies in some hostels of the University were not killed by routine insecticidal treatments and this led to the observations presented in this paper.

Flies were collected from one of the dining halls of the University where a number of chlorinated insecticides have been sprayed since the last several years. The flies thus collected were reared in the laboratory at 28°C. and four-days-old flies obtained from this parental stock were topically tested with Riscella-oil solutions of Lindane. The size of droplet applied was kept constant while the concentration was varied.

TABLE I

Resistance of *Musca nebulosa* to Lindane

Dose	Sex	% Mortality	
		Field collected flies	Laboratory reared normal flies
0.001%	Male ..	70.58	97.36
	* Female ..	82.14	86.11
	Average ..	76.36	91.74
0.01%	Male ..	74.60	100
	Female ..	67.69	100
	Average ..	71.15	100

The results obtained (Table I) indicates that *Musca nebulosa* has developed insecticide resistance under field conditions. A significant conclusion which can be drawn from these observations is the support to the earlier idea of Pal and his associates<sup>2</sup> that field-resistant strains of *Musca nebulosa* are not common because insecticidal operations are usually carried out during malaria transmission season only. In the present case insecticides were regularly

used for fly control during all seasons of the year and thus resistance developed.

Muslim University,  
Aligarh, U.P.,  
March 22, 1958.

Z. H. ABEDI.  
N. H. KHAN.

1. Abedi, Z. H., Resistance of *Musca nebulosa* to Insecticides. *Ph.D. Thesis*, 1957, M.U., Aligarh (unpublished).
2. Pal, R., Sharma, M. I. D. and Krishnamurthy, B. S., *Ind. Jour. Mal.*, 1952, 6, 303-16.

### THE EFFECT OF MOLYBDENUM ON THE RATE OF GROWTH AND NITRATE ABSORPTION BY *CYLINDRO- SPERMUM SPHAERICA*

EVER since Steinberg<sup>6</sup> showed the important role of molybdenum in the nitrogen metabolism of *Aspergillus*, it has been found that traces of molybdenum are very essential for the maximum growth in a medium containing nitrate as the source of nitrogen.<sup>2,5,7</sup> In the green algae like *Scenedesmus*<sup>1</sup> molybdenum has been found to be indispensable for the assimilation of the nitrate nitrogen. Fogg showed that molybdenum was essential for the nitrogen fixation by *Anabaena cylindrica*, since only very little growth occurred in the absence of supplied molybdenum and a higher concentration of molybdenum was required for the maximum growth on molecular nitrogen than on nitrate nitrogen.

A species of *Cylindrospermum* (*C. sphaerica*) was isolated from some cultivated soils and was found to be capable of fixing nitrogen (Venkataraman *et al.*, unpublished). The role of molybdenum on the rate of growth and nitrogen assimilation in terms of the residual nitrogen in the medium, by this alga, was studied and the results are plotted in Graph I.

The material was grown in Fogg's medium<sup>8</sup> provided with 25 mg. nitrate nitrogen per 100 ml. of the culture solution. To one set was added 0.4 mg. sodium molybdate per litre of the solution and in another set, the molybdenum salt was completely excluded. Both the rate of growth in terms of dry weight, and the nitrogen absorption in terms of the residual nitrogen in the medium were estimated at an interval of four days. The results are the averages of triplicates. All the cultures were kept under constant illumination provided by a 200 watts filament lamp placed at a distance of about 3'. The nitrogen estimations were done by the conventional micro-kjeldahl method.

It is observed that in the medium without any added molybdenum there was practically no growth, and after eight days the material got bleached. In the medium with higher concentration of molybdenum (0.4 mg./l.) there was a steady increase in the rate of growth while, in the molybdenum-deficient medium (0.1 mg./l.) the growth was not only poor as compared with the other set, but also showed a decrease after 16 days. Besides, the molybdenum deficient material assumed a pale yellow green colour. This 'yellowing' may, probably, be due to the reduction in the phyco-cyanin pigment.<sup>4</sup> The complete failure in growth without any added molybdenum shows the importance of this element. 0.1 mg. of molybdenum salt was found to be sufficient up to the sixteenth day, but proved to be a limiting factor for growth afterwards. 0.4 mg. was fully adequate for efficient growth throughout the experimental period.

The nitrate assimilation, on the other hand, does not seem to be markedly affected by molybdenum concentrations within the limits examined. In both deficient and high molybdenum cultures, there is a gradual uptake of nitrate as the alga grows, as seen by the decreasing concentration of the nitrogen in the medium (Graph I, curves B, B'), although the

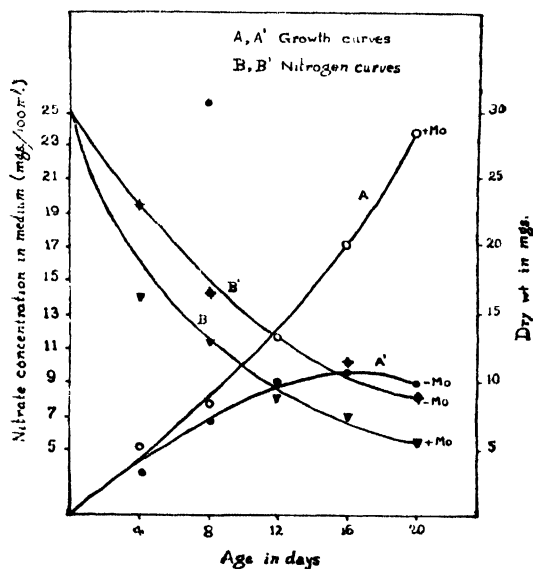

GRAPH I

rate of absorption seems to be more in the high molybdenum cultures which is accountable by the increased growth of the alga in the medium. Similar results have been obtained in *Anabaena cylindrica* also, where the

growth and uptake of nitrate were followed in normal and molybdenum-deficient cultures.<sup>7</sup> In the green alga, it has been found that the function of molybdenum is confined to nitrate reduction.<sup>1</sup> There is no conclusive evidence that the fixation of molecular nitrogen by the Blue-green alga involves the formation and subsequent reduction of nitrate.<sup>10</sup> It is seen that addition of molybdenum to the molybdenum deficient cultures provided with nitrate, enhanced the nitrate absorption, a probable consequence of the increased growth of the alga stimulated by molybdenum.

From the above study it appears that molybdenum, within the limits investigated, does not seem to affect appreciably the rate of nitrate absorption by the alga inasmuch as it affects its rate of growth. This is in conformity with the observations in the higher plants,<sup>6</sup> yeast,<sup>9</sup> and *Anabaena cylindrica*.<sup>2</sup>

I am thankful to Dr. M. S. Randhawa and Dr. B. P. Pal for their keen interest and encouragements. I am highly grateful to Dr. S. M. Sikka for his valuable suggestions during the investigation. My thanks are also due to the authorities of the Chemistry Division, I.A.R.I., for facilities to carry out the chemical part of the work.

Algal Lab., G. S. VENKATARAMAN.  
Botany Division,  
I.A.R.I., New Delhi-12,  
March 24, 1958.

1. Arnon, D. I., et al., *Physiol. Plant*, 1955, **8**, 538.
2. Fogg, G. E. and Wolfe, M., *4th Symp. Soc. Gen. Microbiol.*, 1954, pp. 99.
3. Fogg, G. E., *Ann. Bot. Lond.*, N.S., 1949, **13**, 241.
4. —, *Proc. Roy. Soc.*, 1952, **139B**, 372.
5. Hewitt, E. J., *Ann. Rev. Plant Physiol.*, 1951, **2**, 25.
6. — and James, E. W., *J. Pomol.*, 1947, **23**, 254.
7. Mulder, E. G., *Plant and Soil*, 1948, **1**, 94.
8. Steinberg, R. A., *J. Agri. Res.*, 1937, **55**, 891.
9. Sakamura, T. and Maeda, K., *J. Fac. Sci. Hokkaido Univ.*, 1950, ser. v, **7**, 79.
10. Wilson, P. W. and Burris, R. H., *Bacter. Rev.*, 1947, **11**, 41.

#### ON THE RED ALGA *CORYNOMORPHA PRISMATICA*

THE genus *Corynomorpha* was established by J. G. Agardh<sup>1</sup> in 1872 with two species, *C. prismatica* (J.Ag.) J.Ag. (the type) and *C. clavata* (Harvey) J.Ag., both of which had been previously included under the genus *Acrotylus* J.Ag. *C. prismatica* was based on a specimen collected by Wight from the Indian coast. The alga occurs in abundance at Cape Comorin, S. India,<sup>2</sup> and is also known from Ceylon,<sup>3</sup> E. Africa and Indonesia.<sup>4</sup> Its vegetative organisation has been

well described by Boergesen,<sup>2</sup> but details of reproduction are not fully known. According to the original description, the cystocarps are small and sunken in the spongy, swollen, nemathecoid tips. Tetrasporangia and spermatangia have not so far been observed. Fertile material of the alga was collected by Prof. M. O. P. Lyengar in March 1954, and again by the writer in October 1957. A study of the material revealed a number of interesting features regarding its reproductive structures. A brief outline of these is given here.

The sexual and asexual reproductive structures are borne in nemathecia developed in the younger portions a little below the tip. The nemathecium cover the entire circumference of the fertile regions, which as a result appear swollen. The sexual plants are dioecious.

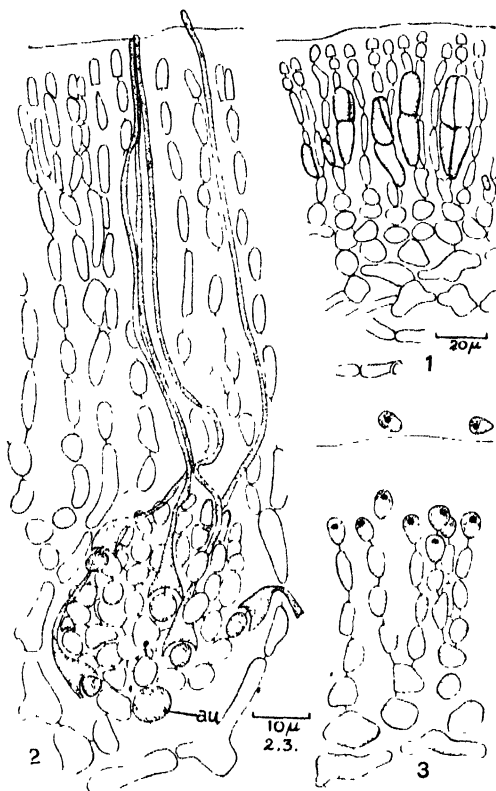

FIGS. 1-3

A section of the male nemathecium shows that the spermatangial mother-cells are terminal on short unbranched nemathecium filaments. The spermatangia are cut off in basipetal succession from the tips of the spermatangial mother-cells and are catenate, as many as four often being found\* in a chain (Fig. 3).

The fertile tips of female plants are much more swollen than those of the male plants. The carpogonia are formed in ampullary clusters which are developed laterally from the nemathecium filaments. Each ampullary cluster contains an intercalary auxiliary cell (Fig. 2, *au*) and a number of two-celled carpogonial branches.

The gonimoblast initial is cut off from the auxiliary cell towards the outside. The numerous small cystocarps are totally immersed in the much swollen nemathecium tips.

The tetrasporangial nemathecium first occur similarly a little below the tips, but later on cover a larger area than do the sexual nemathecium. The tetrasporangia are short, one-celled lateral branches of the nemathecium filaments, and are in general cruciately divided (Fig. 1), though variations from typically cruciate to more or less zonate conditions are also seen.

The alga is at present included in the Cryptonemiaceae. But, it shows several features which are definitely at variance with what is known regarding reproductive structures in the Cryptonemiaceae.<sup>7-13</sup> In the Cryptonemiaceae so far investigated only tetrasporangial nemathecium are known; in *Corynomorpha* all reproductive structures are borne in nemathecium. Again, in the Cryptonemiaceae, carpogonial and auxiliary ampullae are separate and the carpogonial ampullae are unicarpogonial; in *Corynomorpha*, the carpogonia and auxiliary cells are borne together in the same ampullary cluster, and the ampullary clusters are polycarpogonial. Catenate spermatangia as observed now in *Corynomorpha* have not been reported in other Cryptonemiaceae so far investigated.

On account of these differences, it is difficult to retain the genus *Corynomorpha* in the family Cryptonemiaceae. It is, therefore, transferred to a new family, Corynomorphaceae, within the order Cryptonemiales.

*Corynomorphaceae* Fam. nov.—Thallus multi-axial; reproductive structures in nemathecium; ampullary clusters polycarpogonial with an intercalary auxiliary cell; gonimoblast cut off from the auxiliary cell to the outside; spermatangia catenate; tetrasporangia cruciately or sometimes irregularly divided.

With the single genus: *Corynomorpha* J. G. Agardh (type species: *C. prismatica*).

It may perhaps be mentioned that the new family Corynomorphaceae resembles the Endocladaceae in some of its features. But, the thallus in *Corynomorpha* is multi-axial, whereas in the Endocladaceae it is uni-axial.

The second species of *Corynomorpha*, *C. clavata*, has not so far been investigated in any detail. It has been reported only from Florida.<sup>14</sup>

The writer is highly indebted to Prof. M. O. P. Iyengar and Prof. T. S. Sadasivan for encouragement and to Dr. T. V. Desikachary for helpful and critical discussion.

University Botany Lab., M. S. BALAKRISHNAN.  
 Madras-5, April 1958.

1. Agardh, J. G., *Acta Univ. Lund.*, 1872, **8**, 3.
2. Boergesen, F., *J. Indian bot. Soc.*, 1937, **16**, 323.
3. De Toni, J. B., *Syllage algarum*, 1924, **6**, 550.
4. Weber van Bosse, A., *Liste des Algues du Siboga*, 1921, **2**, 240.
5. Balakrishnan, M. S., *J. Indian bot. Soc.*, 1949, **31**, 205.
6. Dawson, E. Y., *Allan Hancock Pacif. Expedn.*, 1954, **17**, 243.
7. Fritsch, F. E., *Structure and Reproduction of the Algae*, Cambridge, 1945, **2**, 635.
8. Kawabata, S., *Bull. Jap. Soc. Phycology*, 1954, **2**, 29.
9. —, *Ibid.*, 1954, **2**, 67.
10. —, *Ibid.*, 1955, **3**, 6.
11. —, *Ibid.*, 1956, **4**, 8.
12. —, *Ibid.*, 1957, **5**, 8.
13. Kylin, H., *Die Gattungen der Rhodophyceen*, Lund, 1956, 214.
14. Harvey, W. H., *Nereis boreali-americana*, 1853, **2**, 196.

### INSECT INCIDENCE AND BRANCHING IN RICE

In rice, normally each culm bears a single ear-head and branching at nodes is exceptional. Some deep-water rices have the characteristic predisposition to produce stems at higher nodes, which may be rightly called branching rather than tillering.<sup>1</sup> Tillers usually spring up from higher nodes also, when the age of the seedlings for transplanting is advanced or when the crop lodges.<sup>2</sup> In some Palmæ, branching is known to occur when the central shoot is killed by borer-beetles or damaged otherwise. In sugarcane, axillary shoots develop into branches when the main shoot dies due to borer damage.

The gall-fly, *Pachydiplosis oryzæ* (W. M.) Mani, causes extensive damage to rice as the tillers attacked by gall-fly turn into long hollow tubular outgrowths known as silver shoots. The attacked tillers eventually die but subsidiary tillers spring up from the basal node of the seedling near the surface of the soil, which is the tillering zone.

In a large number of investigations at Cuttack, it has been observed that the percentage incidence of gall-fly is more in the 90-days-old crop than in the 60-days-old crop and the peak

of infestation fluctuates between the end of August to the end of November.<sup>3</sup> Hence certain early-maturing varieties (*Beali*) grown in June to September are generally found to escape infestation by this pest. But, in some late-maturing varieties, especially GEB 24 and Jelly 175, when the crop is about 120 days old, many tillers possess branches, arising from the third or fourth node, from the bottom. In all such cases, the main tiller is found to have formed into a silver shoot and the axillary bud, usually from the node just below the silver shoot in that tiller, develops into a branch giving the appearance of the main tiller in effect. This branched tiller develops normally, producing an earhead (Fig. 1). It has also been observed

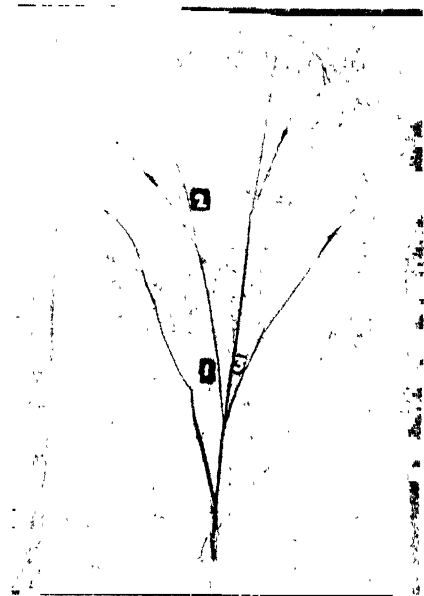

FIG. 1

1. Main tiller formed into a silver shoot due to gall-fly attack, 2. Silver shoot, 3. Branched tiller producing a grain-bearing earhead.

in some cases that the branched tiller is again attacked by gall-fly resulting in another silver shoot and the axillary bud on the main shoot from the node just below the silver shoot develops to form a branch. Very rarely, the axillary buds in two successive nodes below the main silver shoot develop into two branches, even when the first-branched tiller is not attacked by gall-fly.

Similar type of branching is also observed to occur at the shot-blade stage due to the damage caused by stem-borer, *Schænobius incertulas* Walk. The attacked tillers produce chaffy

grains and are known as white earheads. Stem-borer larva gains entry into the stem by cutting a hole just above or below the second node from the top. If the hole through which the larva enters is just above the second node from the top, the axillary bud in the second node develops into a branch. But should the hole be just below the second node, the axillary bud from the third node from the top develops into a branch. In this case also, the branch produces an earhead but it usually remains green and unset at the time of harvest (Fig. 2).

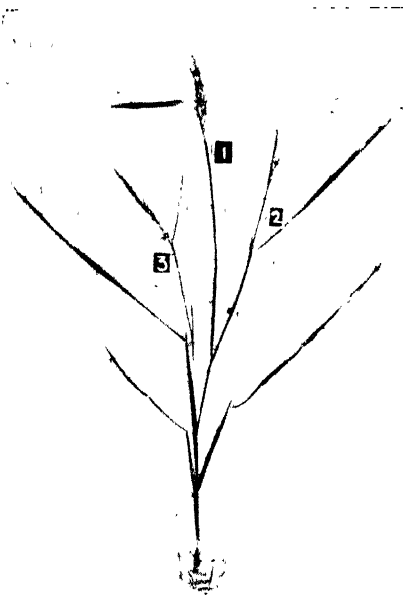

FIG. 2

1. Main tiller with a white earhead due to stem-borer attack; 2-3. Branched tillers bearing earheads with unset grains.

due to gall-fly incidence. Some of these were later attacked by stem-borer on account of which the earheads of the branched tillers became chaffy. In this case also a branch was noticed to arise from the node just below the stem-borer hole resulting in an earhead. These observations are of importance in assessing the loss caused by the two pests, gall-fly and stem-borers.

In order to estimate the extent of compensation in yield, as contributed by the earheads of branched tillers, differences in the earhead length and the number of sound grains between the normal earheads and earheads of the branched tillers due to gall-fly, were examined in a large number of samples and the data is given in Table I.

It can be seen from the table that the earheads produced by branched tillers are smaller in length with fewer sound grains. The mean weight of grains is significantly more in earheads of branched tillers, probably because the number of sound grains being fewer, they are heavier. It is clear that the branched earheads do compensate loss in yield and in the above case, this compensation is found to be 63.7%. In estimating the loss due to gall-fly, it is important to take this fact into consideration.

The authors' grateful thanks are due to Dr. N. Parthasarathy, for the interest taken in the work.

Central Rice Res. Inst.,  
Cuttack,

P. ISRAEL.

G. VEDA MOORTHY.

January 31, 1958.

TABLE I

	Mean earhead length in cm.	Mean No. of sound grains per earhead	Percentage unfilled grains per earhead	Mean wt. of sound grains per earhead in gm.	Mean wt. of 125 grains in gm.
Normal tiller ..	27.78*	136.24*	13.07	2.48*	2.251
Branched tiller ..	23.28	84.48	13.21	1.58	2.347*
Standard Error of difference	0.8765	11.61	2.094	0.217	0.00902

\* Significant at 1% level.

In the main crop season in 1955 (June-December), both gall-fly and stem-borers were prevalent during the middle of October when the following interesting phenomenon was observed. In the varieties GEB 24 and Jelly 175, branching as described above, was observed

1. Jones, J. W., "Branching of Rice Plants", *J. Amer. Soc. Argon.*, 1925, 17, 619-23.
2. Ramiah, K., *Rice Breeding and Genetics, Scientific Monograph No. 19*, 1950, Indian Council of Agricultural Research, New Delhi.
3. Central Rice Research Institute, *Annual Reports*, 1948-55.

**CHROMOSOMES OF THREE SPECIES  
OF SOUTH INDIAN PULMONATE  
SNAILS OF THE GENUS *CRYPTOZOONA*  
MORCH.**

THE number of Molluscs whose chromosomes have been studied is about 135. Of these, 89 are Pulmonates, which do not include any of the Indian species. I have been investigating the chromosomes of South Indian Pulmonates, and the present note relates to the chromosomes of the three species of common garden snails.

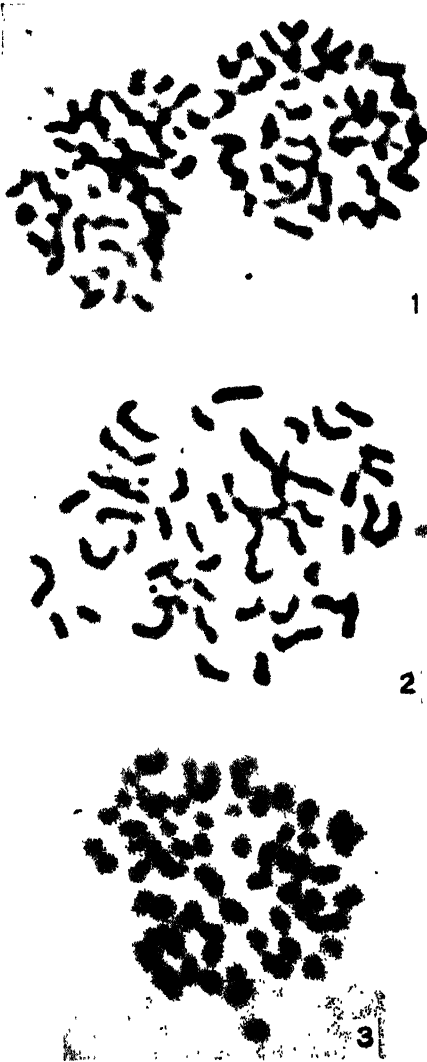

FIG. 1. Polar views of two spermatogonial metaphase plates—photomicrograph—acetocarmine squash—*Cryptozona bistrialis*,  $\times$  ca 4,000. FIG. 2. Photomicrograph of pro-metaphase stage of *Cryptozona semirugata*—acetocarmine squash,  $\times$  ca 4,000. FIG. 3. Photomicrograph of spermatogonial metaphase plate of *Cryptozona ligulata*—polar view—acetocarmine squash,  $\times$  ca 4,000.

*Cryptozona (Xestina) bistrialis* Beck., *Cryptozona (Nilgiria) semirugata* Beck. and *Cryptozona ligulata* Fer., formerly known as *Ariophanta bistrialis* Beck., *Ariophanta semirugata* Beck., and *Ariophanta ligulata* Fer. respectively. The chromosomes were studied mainly from acetocarmine and Feulgen squashes.

*Cryptozona bistrialis*.—The number of chromosomes as determined from a study of a number of spermatogonial metaphase plates is  $2n = 54$ . A polar view of two such plates is shown in Fig. 1. All the 54 chromosomes are metacentrics and appear distinctly two-armed, with median centromeres. Six chromosomes are larger in size while the rest are uniform in size and shape.

*Cryptozona semirugata*.—The diploid chromosome number of this form is 56 and a clear preparation of a prometaphase stage is shown in Fig. 2. All the chromosomes are metacentrics and can be grouped serially in pairs in order of their size as follows:—

- (i) One pair of large chromosomes with submedian centromeres.
- (ii) Three pairs of large chromosomes with median centromeres, and
- (iii) Twenty-four pairs of small chromosomes, uniform in size, with median centromeres.

*Cryptozona ligulata*.—A polar view of the spermatogonial metaphase plate (Fig. 3) shows 64 chromosomes—all metacentrics. They resolve into 32 homologous pairs, of which 4 pairs are large and the rest are smaller and uniform in size and shape. Of the four larger pairs, two pairs of chromosomes possess submedian centromeres. The other two larger pairs and also the 28 pairs of small chromosomes have median centromeres.

Table I shows the chief differences between the chromosomes of the three species.

TABLE I

No.	Name of species	Diploid chromosome number	Big chromosomes		Small chromosomes
			Submedian centromere	Median centromere	Median centromere
1	<i>Cryptozona bistrialis</i>	54	6	..	48
2	<i>Cryptozona semirugata</i>	56	6	2	48
3	<i>Cryptozona ligulata</i>	64	4	4	56

Forty-eight, fifty-four, fifty-six and fifty-eight are the commonly occurring diploid

chromosome numbers in Helicidae and the highest number reported so far in Pulmonates is 62, in *Polygyra appressa* by Pennypacker (1930) (cited by Makino<sup>1</sup>) and in *Tridopsis fraudulentata* by Husted and Burch<sup>2</sup> (1946). In the present study, it has been found that *Cryptozona ligulata* has  $2n = 64$  the highest number to be recorded so far.

I have great pleasure in expressing my sincere thanks to Professor R. V. Seshaiya, Head of the Department of Zoology, Annamalai University, for suggesting the problem and also for guidance and help. To the Ministry of Education, Government of India, my thanks are due for the award of a Senior Scholarship.

Department of Zoology, R. NATARAJAN,  
Annamalai University,  
Annamalainagar P.O., April 9, 1958.

1. Makino, S., *An Atlas of Chromosome Numbers in Animals*, Iowa State College Press, Ames, Iowa, 1951.
2. Husted, L. and Burch, P. R., *Amer. Nat.* 1946, **80**, 410-29.

#### CYCADOPTERIS sp. FROM THE RAJMAHAL HILLS, BIHAR

THE first report, from India, of *Cycadopteris* sp. was made by Bose (1957) from Bansa, South Rewa Gondwana Basin. Two more fragmentary specimens of *Cycadopteris* have now been noticed by the author in a collection of fossil plants made by Dr. S. C. D. Sah in 1955, near the village Chunakhal (25° 13' 30" N; 87° 79' 52"), Rajmahal Hills, Bihar. Both the specimens are in the form of impressions and are too incomplete to have a specific name. So they are described as *Cycadopteris* sp.

*Cycadopteris* sp. (Fig. 1).—Leaf incomplete, pinnate about 1 cm. broad. Pinnæ attached to a fairly thick rachis, closely set and not over-



FIG. 1. *Cycadopteris* sp., no. 29733, × 2.

lapping; obovate: apex rounded; base truncate; margin revolute. Median vein faintly marked, secondary veins also visible.

Locality: Chunakhal.

Age and Horizon: Jurassic, Rajmahal series.

Collection: Specimen No. 29733 of Birbal Sahni Institute of Palaeobotany Museum.

The present specimens differ from *Cycadopteris* sp. described by Bose (1957) in having shorter and broader pinnæ attached to a fairly thick rachis; here both median and secondary veins are present, whereas, in the latter the rachis is slender and the median vein alone is visible. Like *C. anglica* Gothan (1914) and *C. zeilleri* Antevs (1915), the present species do not have the turned-under flange over the midrib and the secondary vein. The shape of the pinnæ is different in our specimen.

Birbal Sahni Institute of M. N. BOSE.

Palaeobotany,  
Lucknow, April 11, 1958.

1. Antevs, F., *Geol. Förm. Stockholm Förhandl.* 1915, 37.

2. Bose, M. N., *Palaeobot.* 1957, **6**, 2

3. Gothan, W., *Abh. Naturhist. Ges. Nürnberg*, 1914, **19**, 4

#### CYTOLOGICAL STUDIES IN *FISSIDENS* *ELIMBATUS*, BROTH, A LOCAL MOSS

CYTOLOGICAL investigations in Bryophytes have received much less attention than those on the higher plants. This group, therefore, remains an almost unexplored source of research materials<sup>1</sup> This is especially true with regard to Indian Mosses in which hardly one or two papers worth the name have appeared of late.<sup>2</sup> Besides other reasons, the difficulties in getting good cytological preparations in this group of plants appear to be the chief obstacle in the progress of cytological research. However, efforts are being made in this laboratory to undertake cytological studies of the local mosses with a view to throw light on the cyto-taxonomical aspect of different genera. A preliminary account of the cytological work done in one of the local moss species, *Fissidens elimbatus*, is being reported here.

This moss *F. elimbatus* appears on the bank of the Ganges in the months of October-December. The capsules appear in November-December. For cytological studies, patches of plants were brought to the laboratory and capsules were squashed in propionic orcein which gave much better results than other stains of this group. Division stages were found in the morning between 10-12 A.M. Studies were made from temporary slides and their microphotographs.

The chromosome number of the species as determined in meiotic stages was  $2n = 12$ . Mitotic plates obtained from the wall cells of the capsule also showed 12 chromosomes (Fig. 1) at the metaphase plates. The chromo-



FIG. 1. *F. limbatum*, microphotograph showing 12 chromosomes at mitotic metaphase  $\times 1,900$ . Some are extremely minute defying detailed analysis. They appear to have median or submedian centromeres.

Meiotic prophases in mosses are unfavourable for study at present. The same was found true with the Liverworts.<sup>3</sup> Prophase stages earlier or later than pachytene have rarely been observed, which is suggestive of the shortness of these stages. A typical diakinesis has not been found. The earliest prophase is the centrally located nucleus which later becomes vacuolated making ring-like appearance.

At the first metaphase (Figs. 2 and 3), the



FIG. 2. *F. limbatum*, microphotograph showing bivalents at I meiotic metaphase,  $\times 2,800$ .

six bivalents are oriented at the centre of the spindle. One of the bivalent is suggestive of



FIG. 3. *F. limbatum*, camera-lucida diagram of the plate, in fig. 2,  $\times 2,800$

sex chromosomes, being feebly stained and larger in size. The anaphase I is quite normal (Fig. 4). At anaphase, the chromatids of biva-



FIG. 4. *F. limbatum*, camera-lucida diagram of the I meiotic anaphase,  $\times 2,000$ .

lents do not seem to separate from each other. The separation of chromatids at II anaphase with rigidly elongated structure is characteristic.

Cytokinesis leading to tetrad formation takes place only after the completion of the second meiotic division.

The chromosome numbers of some of the species of *Fissidens*, which have been reported before, show variation; namely, *F. limbatum*,  $n = 5$ , and *F. pauperculus*,  $n = 12^4$ ; *F. cristatus*,  $n = 16$ , *F. cristatus* var. *minor*,  $n = 16$ , and *F. japonicus*,  $n = 16^5$ .

In the case of *F. limbatum* it is  $n = 6$ . If 5 is the basic chromosome number as reported



in the case of *F. limbatus*, the genus *Fissidens* appears to show a polyploid range. We propose to give a more detailed account of the karyotype study of the different local species later.

Botany Dept., R. P. ROY.  
Patna University, M. K. JAIPURIAR.  
Patna, March 18, 1958.

1. Vaarama, A., *Congr. Intern. de Botanique*, Paris, Sections 9 et 10, 1954, **10**, 89-90.
2. Pandć, S. K. and Chopra, N., *Jour. Ind bot. Soc.*, 1957, **36** (3), 241-47.
3. Lorbeer, G., *Jahrb. f. wiss. Bot.*, 1934, **80**, 565-817.
4. Steere, C. W., VIII' *Congr. Intern. de Botanique*, Paris, 1954.
5. Yano, Koji, *Bot Mag. Tokyo*, 1951, **64** (761-62), 234-37.

#### CYTOPLASMIC MALE STERILITY IN JOWAR (*SORGHUM VULGARE PERS.*)

In the *jowar* (*Sorghum vulgare Pers.*) culture, I.C. 2360, grown in this Division in 1955, a sterile-looking plant was located. The single ear produced by this plant bore only a few grains; microscopic test for pollen fertility, using the stain acetocarmine, revealed that the pollen was totally sterile. The plant was sibbed, using pollen from a normal, fertile plant belonging to the same culture. The progeny, raised in 1956 from this sibbed seed, was found to be completely male-sterile. These male-sterile plants were again sibbed, using pollen from fertile plants of the parent culture (I.C. 2360); all the 25 plants, grown from this seed in 1957, were again completely male-sterile. This indicated that the male-sterility exhibited by this line was cytoplasmic. The line is now being crossed with a number of distinct genotypes with a view to locating those which would restore fertility as well as those which, like I.C. 2360, would perpetuate sterility.

Stephens and Holland (1954) reported from Texas (U.S.A.) cytoplasmic male-sterility in *jowar*; this type of sterility is conditioned by

the interaction between nuclear and cytoplasmic factors. The American male-sterile line, together with its fertile counterpart, is being maintained in this Division and has been utilised in crossing with a number of Indian forms, including I.C. 2360. The results obtained so far suggest that the male-sterility observed in I.C. 2360 is of the nature of cytoplasmic-nuclear gene interaction as reported by Stephens and Holland (*loc. cit.*).

From the view-point of utilisation in hybrid seed production in India, the present male-sterile line appears to be of direct advantage as compared to the one from the U.S.A. In this country, *jowar* is grown for fodder and also for grain which is used as human food. Consequently, tall plant habit, compact heads, and bold, white pearly grains are among the most desired characters. The American male-sterile line (Texas Blackhull Kafir) is dwarf and possesses semi-loose heads with small, dirty-white soft grains. As such it would require a lengthy backcross programme to be used for hybrid seed production. The present male-sterile line, on the other hand, can be utilised directly as it possesses almost all the desired features.

Male-sterility conditioned entirely by nuclear genes has been reported in *jowar* both in the U.S.A. (Stephens, 1937) and in India (Ayyangar and Ponnaiya, 1936; Kajjari and Chavan, 1953). It is, however, not so feasible to use such male-steriles for hybrid seed production for which cytoplasmic male-sterility is the best answer. The present report constitutes the first record of cytoplasmic male-sterility in *jowar* in India.

Division of Botany, S. P. MITAL.  
Indian Agric. Res. Inst., VISHNU SWARUP.  
New Delhi, April 21, 1958. A. B. JOSHI.

1. Ayyangar, G. N. R. and Ponnaiya, B. W. X., *Curr. Sci.*, 1936, **5**, 390.
2. Kajjari, N. B. and Chavan, V. M., *Indian J. Genet. Pl. Breed.*, 1953, **13**, 48.
3. Stephens, J. C., *J. Amer. Soc. Agron.*, 1937, **26**, 690.
4. — and Holland, R. H., *Agron. J.*, 1954, **46**, 20.

#### BORON ROCKET FUELS

UNIVERSITY of Michigan chemists have been working since 1952 on the "ground rules" for the development of the new high energy boron rocket fuels.

Boron fuels have recently been identified as one of this country's major new rocket propellants. Boron compounds are made up of relatively light elements which release far more

energy than conventional petroleum fuels when they burn, providing as much as one and one-half or two times as much thrust per pound. Many of the boron-hydrogen compounds are unstable materials which have had to be "tamed" before they could be put to work as practical fuels.

---

---

## REVIEWS

---

---

**Statistics for the Social Sciences.** (*An Introduction to Statistics for the Social Sciences.*) Second Edition. Enlarged by T. G. Connolly and W. Sluckin. (Cleaver-Hume Press Ltd., London.) Pp. viii + 166. Price 16 sh. net.

"The book is written for those students who have to satisfy examiners in statistics and also need for their studies a degree of statistical insight, yet have no knowledge of Mathematics beyond simple Arithmetic"—(from the author's preface). To achieve this object, the authors restrict the scope of the book, perhaps justifiably, to elementary statistical methods essential for summarising observational data and present full details of the computations involved. Descriptive statistics dealing with frequency distributions, measures of central tendency and variability, ogive, the normal distribution curve and correlation is covered in the first five chapters and partially in Chapters IX and X. The inference part of statistics of arguing from a sample is treated in the other chapters. The ideas of sampling, reliability of estimates and testing of hypotheses have been explained in a simple manner and the beginner may not have much difficulty in following them. The last chapter (XI) on the analysis of variance is a welcome addition in the second edition of the book. The detailed computational layouts for evaluating the statistical measures will be very useful to statistical computerers.

A few comments by way of criticism are called for. No warning is given, anywhere, about the pitfalls in the application of statistical methods to sociological and psychological data. This could have been done by proper choice of examples and explanations as to the suitability of particular methods employed. There is some confusion caused by the use of the same notation for sample estimates as well as for the population constants. The reference to  $t$  table in setting up the confidence limits to  $\sigma$ , the population standard deviation as indicated on page 96 is not a correct procedure. The chi-square test for goodness of fit of a normal distribution discussed on pages 116-17 is different from the one generally used. Perhaps the usual method of comparing the observed frequencies with the expected instead of the ordinates is more appropriate.

C. R. RAO.

**Structure Reports.** Vol. XV. Editor: A. J. C. Wilson; Section Editors: N. C. Baenziger, J. Wyart, J. M. Robertson. (Published by the International Union' of Crystallography by N. V. Oosthock's Uitgeners, MIJ, Domstraat 1-3, UTRECHT), 1951. Pp. viii + 588. Price \$ 29.00.

This volume of structure reports is divided into three sections, namely, Metals, Inorganic Compounds and Organic Compounds. In Metals Section, the arrangement is alphabetical, while in the other two Sections, it is according to the increasing complexity of composition; related substances and related structures have however been kept together as far as possible.

The increasing interest in the properties of metals and alloys in recent years have resulted in a phenomenal growth of the subject from the structural point of view. Transformation in metals, of Martensitic as well as diffusion induced slow type, order-disorder phenomena and precipitation hardening in alloys and their relationships to their thermal history composition, etc., and interesting magnetic properties of certain alloys have led to the search for their ultimate cause which in turn is intimately connected with their structure.

Section I is one of the most interesting part containing valuable data and discussions for over one hundred and eighty metals and alloys.

Section II devoted to Inorganic Compounds abounds in the wealth of material presented. Particular mention may be made of oxides and double-oxides, which include substances exhibiting very interesting properties such as spinels, some titanates and niobates noted for their magnetic and ferroelectric properties respectively. A vast number of mineral structures of varying complexity have been reported, and among them particular mention may be made of tourmalines. A large number of examples of the phenomenon known as epitaxy, that is, the crystal overgrowth on crystals have been presented. Electron diffraction studies have been particularly helpful in the study of overgrowths.

The versatility of carbon in its power to combine readily with itself and with other elements and groups has resulted in millions of compounds being synthesised and identified in nature. Crystallographers have taken to these compounds in spite of their complexity, and we

find today that increasing number of them turning their attention to the solution of organic structure of extreme complexity such as proteins and other biological products. As a result of these investigations in this field, diffraction by helical structures and cylindrical lattices have been developed.

Section III reflects the popularity of organic compounds among crystallographers and contains valuable data for a vast number of organic compounds, from simple aliphatic, aromatic cyclic, and heterocyclic compounds to complex proteins.

The volume is an invaluable reference book, not only to workers who are directly concerned with structure analysis and physical metallurgists, but also to physicists and chemists. The volume has abstracted profusely papers that have appeared in journals of other languages such as the Russian journals, and this is certainly a most useful aspect.

A. J.

---

**Radiation Effects in Solids.** By G. J. Dienes and G. H. Vineyard. (Interscience Publishers, New York; India: Asia Publishing House, Bombay-1), 1957. Pp. viii + 226. Price \$ 6.50.

The recent failure due to radiation damage of one of the atomic power stations in Britain has focussed the attention of physicists on the all-important problem of radiation effects on solids. The fact that energetic neutrons and fission fragments would have the ability to displace atoms from their equilibrium positions, which might lead to serious changes in the physical properties of a solid was realised as early as 1942 by E. P. Wigner but most of the work done since then (both technological and basic) has been under classified material till the Geneva Conference in 1955. Studies on this subject are proceeding more intensely than ever and this subject is expected to make great strides in the next few years. In view of the accumulating literature it has become imperative that an attempt be made to survey the present state of knowledge setting forth the basic aspects of the theoretical and experimental advances. Such an attempt has been made with success by the authors, of the book under review. The authors have mostly confined themselves to present the physics of the effects of energetic radiation on solids.

The present interpretation of the changes in the properties of solids brought about by high energy radiation, centres round the production of interstitial and impurity atoms. The

process of their formation and statistical enumeration and the dynamics of their movement at different temperature forms the major part of the book. After defining clearly the above-mentioned three entities as also the replacement collision, thermal and displacement spikes (Chapter I), the thesis of displacement production and the basic experiments designed to test the major aspects of the theory are given (Chapters II and III). Point defects and cluster defects and the changes associated with the physical properties such as electrical conductivity, thermal conductivity, elasticity, optical and magnetic properties have been treated. A brief reference is made to the use of X-ray diffraction techniques to observe some types of lattice imperfections. Chapter V deals with the question of the mobility of crystalline defects and the annealing of radiation defects by recombination processes or their disappearance due to diffusion. Chapter VI deals rather too briefly on such varied topics as mechanical properties of metals, changes in the dimensions of uranium on irradiation, radiation growth, phase transformation, precipitation from solid solution, chemical effects, etc.

The authors have concentrated mainly on fundamentals of the processes and do not attempt to give too many details of engineering interest, although most of the striking effects of radiation, affecting technology have been surveyed. The subject-matter has been presented in an attractive and understandable manner and the book can be most warmly recommended, for any one interested in gaining a good grounding of these fascinating subjects.

S. R.

---

**Three Steps to Victory.** By Sir Robert Watson-Watt. (Odhams Press, Ltd., Long Acre, London), 1958. Pp 480. Price 30 sh. net.

The title of this book might perhaps induce the readers to believe that they have stumbled upon a trail leading to success in life, and that in just three steps. And if they do turn the pages of this book with any such delectable visions, they will not be utterly disillusioned. For, 'Three Steps to Victory' relates what the enthusiastic, tireless and sustained efforts of the intellect of man could accomplish. It combines in itself an autobiography and a biography—the autobiography of Sir Robert Watson-Watt who, for his pioneering work in the field of radar, has been honoured with the paternity of this conception of human ingenuity and skill, and the biography of the radar, its origin and

development through the various stages to its present state of perfection.

Though the radar is equally useful in other fields like meteorology and navigation, its importance has been impressively demonstrated in its application to warfare, especially aerial warfare and defence against aerial attack. The introduction of aircraft with all its destructive propensity into the warfare set the warring nations of the world on a race to devise technological ways and means of locating aircraft while air-borne. Radio direction and range-finding or 'radar' for short—from the I.F.F. (Identification, Friend or Foe) to the Oboe which permits the most accurate bombing run, from Gee to the most portable of all radar systems, 'Rebecca-Eureka'—is the operational-technical system brought forth by technologists to fulfil this imperative need. This radar system applicable to naval operations, anti-aircraft gunnery and all other radar-aided military operations—dropping of troops, agents and supplies from air, etc.—was used in the air defence of Great Britain, and in the initial stages of the anti-U-boat war and was responsible for Britain's victory in the Battle of Britain, the Night Battle of the British Cities and the First Battle of Atlantic.

Sir Robert Watson-Watt recounts in this book the birth of the idea of the radar, the early difficulties and failures he encountered on the technical side as well as in the training of personnel required to man the system and the race against time to put Britain under a 'radar cover' before Hitler struck in Europe. What make the reading all the more interesting are the back-stage anecdotes told with a touch of humour and the part played by the Governmental machinery in the birth of a technological system destined to play a very vital role in the history of our times. M. S. S.

---

**Magnetism.** (The Indian Association for the Cultivation of Science, Jadavpur, Calcutta). 1957. Pp. 232. Price Rs. 7.

This book is a collection of twenty-three papers presented at the Symposium on Magnetism held in 1954 under the joint auspices of the National Institute of Sciences of India and the Indian Association for the Cultivation of Science. They can be roughly grouped under four headings, namely, (1) Discussions on diamagnetic and para-magnetic properties, (2) Magneto-chemical applications, (3) Nuclear magnetic resonance, particularly nuclear induction, and (4) Ferro-magnetic materials. The Inaugural

Address by the late Professor M. N. Saha is immediately followed by two papers on the measurement of magnetic fields.

In spite of its delayed appearance, the book would interest magneto-chemists and workers in the field of modern magnetism and particularly those who are concerned with the nuclear magnetic resonance.

---

**Advances in Enzymology.** Vol. XIX. Edited by F. F. Nord. (Interscience Publishers, Inc., New York; India: Asia Publishing House, Bombay-1.) Pp. v + 457. Price \$9.85.

The present volume, the nineteenth in the series of the *Advances in Enzymology*, contains five essays written by well-known biochemists and enzymologists. Editor Nord has, of late, been concentrating on less and less number of topics in each volume giving thereby greater attention to a detailed and exhaustive survey in selected fields of enzyme research. Thus in the volume under review, W. Vishniac, B. L. Horecker and S. Ochoa have written jointly the first essay on 'Enzymic Aspects of Photosynthesis'. Therein, they have discussed general patterns of carbohydrate metabolism, carbon dioxide fixation reactions as well as reactions which are light dependent and have very ably reviewed the recent advances in this field. In the second article on 'Mechanism of Oxygen Metabolism', H. S. Mason has dealt with the enzymes, which catalyze the reactions of molecular oxygen under the following three broad divisions: (i) the oxygen transferases, (ii) the mixed function oxidases, and (iii) the electron transfer oxidases. The author observes that with the exception of lipoxidase, the oxygen transferases contain heavy metal which appears to be active in reduced form, while the mixed function oxidases transfer only one atom of the oxygen molecule to substrates. The electron transfer oxidases, on the other hand, catalyze two electron transfer to oxygen only or to oxygen and other acceptors. A distinguishing feature of this article by Mason is the compilation in one tabulated statement of all that is known about metabolic hydroxylation of over a hundred different drugs and other organic substances.

Similarly, the third article on 'Aktivierung von Aminosäuren' written in German by T. Wieland and G. Pfeleiderer and the fifth article in French on 'Les Voies Principales de L'assimilation et dissimulation De L'Azote chez Les animaux' by A. E. Braunstein of Moscow are both comprehensive and lucid in their scope and treatment of the subject. The fourth one

on the "Properties of Papain" by J. R. Kimmell and E. L. Smith is perhaps an article on a rather restricted field of study. Nevertheless, the conclusions drawn have a great bearing on the nature of the mechanism of enzyme action. Thus, the earlier vague and indefinite views with regard to the formation of enzyme substrate complexes have been replaced by chemical formulations, which emphasize compound formation. Further, this study of the properties of papain has shown the important role of thiol groups as well as the significance of 'side chain specificity' in enzyme catalysis. We have yet to know why and how two thiol enzymes such as urease and papain act differently.

The get-up of the book is excellent and there is a cumulative index of Volumes I to XIX towards the end of the book in addition to the usual author and subject index found in every volume of this series. This volume of the *Advances* should, in the reviewer's opinion, prove as invaluable as the earlier ones to all those interested in enzymes and related subjects in biochemistry.

P. S. SARMA.

---

**Advances in Protein Chemistry.** Vol. XI. Editors: M. L. Anson, K. Bailey and J. T. Edsall. (Academic Press, Inc., New York), 1956. Pp. x + 665. Price \$12.00.

The eleventh volume of *Advances in Protein Chemistry* is similar to its predecessors in that recent developments are reviewed and discussed by people active in and familiar with specific areas of the field of protein chemistry. The first review in this issue is by C. B. Anfinsen and R. R. Redfield and covers Protein Structure in relation to Function and Synthesis. The authors succeed in their stated purpose of reviewing the major recent developments in the study of amino acid sequence in proteins, including a consideration of some basic methodology. Information about the correlation of covalent and non-covalent structure with the physical and functional properties of proteins is also dealt with in this article. Closely allied to this subject is the review article on Column Chromatography of Peptides and Proteins by S. Moore and W. H. Stein. This review is a wealth of information on the methods of separating peptides and proteins by different materials, especially on ion-exchange resins. Specific proteins are discussed in detail under the section on the chromatography of proteins. Choh Hao Li has summarised the work done on the growth hormone (somatotropin) and adrenocorticotrophic hormone (ACTH and corticotro-

pins) in his review on Hormones of the Anterior Pituitary Gland, Part I. The author, in his concluding remarks, poses some legitimate questions about the *actual* nature of protein or peptide hormones, as they occur in the body in the role of physiologically active catalysts. *Counter-current Distribution in Protein Chemistry* (translated from German) as covered by P. von Tavel and R. Singer deals with a technique familiar in organic chemistry but unfortunately so little used in biochemistry. This review includes a discussion of the basic principles, technical aspects and applications of counter-current distribution. The authors have presented useful information on the conditions under which counter-current distribution can be successfully applied in protein chemistry. F. R. N. Gurd and P. E. Wilcox have an exhaustive review on Complex Formation between Metallic Cations and Proteins, Peptides and Amino Acids. Metal-protein complexes have recently emerged as a central problem of biochemistry, especially of enzymology. This review concerns itself mainly with those metal-protein complexes which are reversible and which can be characterised in terms of chemical equilibria. Pertinent high points in the chemistry of simple metal complexes are also reviewed. Measurement and Interpretation of Diffusion Coefficients of Proteins, as the title indicates, will be of great interest to the physical chemist but should interest biochemists also, as some of the applications of this phenomenon to biological systems are given. Since the mechanism of certain drugs is explained solely on the basis of their diffusion, the review may be perused with profit by the pharmacologist also.

This volume, as the others in the series, is an excellent source of concisely stated information and of references to the literature on the particular subjects covered.

T. RAMAKRISHNAN.

---

**The Chemistry and Biology of Yeasts.** Edited by A. H. Cook. (Academic Press, Inc., New York), 1958. Pp. 246. Price 25 guilders.

There has been an acceleration of the tempo of investigations on yeast during the past few years. The rapid progress in the different directions, as a consequence, has made it increasingly difficult for investigators in one discipline to keep track of the significant discoveries in the others. This volume, written by a panel of specialists, attempts to integrate the recent advances.

A varied fare is offered to the reader. The chapters on classification, ecology, life-history, cytology and genetics are followed by those on chemical composition, fermentation and respiration, cellular carbohydrates and nitrogen metabolism. Problems relating to yeast technology, pathogenic yeasts, food spoilage by yeasts and flocculation of yeasts are considered in the concluding chapters.

Researches in some directions have been in progress for the past one hundred years and modern concepts are only an integration of the past and present data. "It should be kept in mind, however, that even the latest concepts may have to be reinterpreted and extended as additional evidence arises" (Nord and Weiss, p. 323). In general, the reviews are objective as the following excerpts would show. "For example, the question arose whether such a series of reactions obtained from cell-free extracts or artificial enzyme systems constituted a mirror-image of the exact steps occurring within the living cell. Furthermore, did it represent the only metabolic pathway which the micro-organism could efficiently utilize for catabolic purposes, or were there other metabolic routes by which dissimilation of the same substrate could occur?" (Nord and Weiss, p. 324.)

Objective presentation was apparently not easy, for, Treveleyan remarks "that many authors have burdened their papers with discussions of almost theological subtlety in an effort to fit fact to theory" (p. 420). This is too true with regard to the review on Yeast Cytology (Winge and Roberts, pp 109-19) in this volume itself. The problems are not viewed from a historical perspective. The discovery of the nucleus in living yeast cells dates back to 1844. That it is a vesicle with a nuclear membrane was shown from living as well as stained preparations as far back as 1896. Guilliermond (1902-20) reported as identical structure for the nucleus in stained preparations. In fact, he discussed binucleate stages using the nuclear membrane as a marker.

But none of the above details are found in the review. On the other hand, it is stated: "It is clear that this wide divergency of opinion makes it at present very difficult, if not impossible, to form a clear generally acceptable picture of the structure of the nucleus of a yeast cell and the identity and function of the other intracellular structures" (p. 110). "The basis for this lack of agreement is first to be found in the fact that the yeast nucleus is extremely small (the diameter of the stained chromatin in a resulting nucleus

is only about  $0.5-1.5 \mu$ ) and also because it is a most difficult task to elucidate the actual structure of the nucleus" (p. 109). One is left wondering whether the chromatin occupies the whole of the resting nucleus or only a portion of it. There is no reference to the nuclear membrane described by the earlier investigators.

The review concludes: "Even though many investigators claim to have demonstrated the existence of polyploidy in yeasts, it should be remembered that so-called polyploid segregation may be explicable on the basis of supernumerary mitoses, and binucleate spores" (p. 119). The review on Yeast Cytology recalls to one's mind the following comment of Prof. MacBride, on the impact of Genetics on Cytology, made several years ago. "It was the function of the cytologist to provide the material phenomena upon which the geneticist could build his theories. As genetical research continued to find peculiar and exceptional phenomena necessitating modifications and additions to previous theories, so cytologists attempted to find their equivalents in cell structure and behaviour. Thus arose a peculiar position in which genetic theory outran cytological observations even to the limit of the resolving power of the microscope".

The volume, however, is a mine of information and is worth careful perusal by biologists and biochemists alike.

M. K. SUBRAMANIAM.

**The Grassland and Fodder Resources of India.** (*Scientific Monograph No. 22.*) By R. O. Whyte. (Indian Council of Agricultural Research, Queen Victoria Road, New Delhi), 1958. Pp. iii + 437. Price Rs. 16.

This monograph deals with the review of past and present knowledge and experience on the nature and utilization of the grazing and fodder resources as a whole and to relate this information to other branches of land utilization, agriculture, animal husbandry and forestry in India.

Chapter I is introductory; Chapters II, III and IV deal with livestock problems including Indian resources of feed stuffs, their demand and supply and their quality. The prevailing malnutrition of cattle is explained and the need for proper feeding, which is estimated to step up milk production by 100% is stressed. Emphasis is laid on grassland management to increase fodder production. Statistics are given to show that the feed stuffs and fodder available at

present are highly inadequate and serious quantitative deficiencies are noticed and that their quality is also very poor.

Chapters V and VI deal with the ecology of our grasslands, which are a result of biotic climax. The grassland types in India, in the different agricultural zones, their predominant grass species and their progressive and regressive succession is given. This information will offer a basis for the evaluation of the status of grasslands and facilitates their further improvement.

Chapter VII deals with the present position and possible extension of fodder production in India. Methods are suggested for increasing the production and/or use of improved varieties of crops, which provide the major source of roughage for cattle: exploiting forest trees as a source of fodder under a planned programme; growing of fodder trees along with others in plantations; prohibiting the use of edible oil-cakes as manures.

In Chapter IX, the possibilities of improvement of the village grazing lands are reviewed. The major distribution of cattle is in villages and they depend largely on village grazing lands for fodder. The grazing lands are poor in carrying capacity and almost devoid of any vegetation due to over-grazing. Western methods of raising pastures are not practicable, owing to competition by food and cash crops, so the only practical way is to improve the grasslands on an ecological basis. For this, the ecological status of our grassland is to be determined first, by studying the stage of succession, and then the biotic factors acting on the grasslands should be controlled. The chief factor being the grazing, controlled and rotational grazing and reduction in the intensity of grazing are suggested. The practice common in many areas of having wide bunds, placed frequently in fields, which provide grazing for cattle and controls erosion also, is however not mentioned.

Chapters XI and XII deal with forest grazing, its importance and compatibility between forestry and grazing. The advantages of controlled grazing, the disadvantages of indiscriminate and over-grazing are described. Considering the good and bad of forest grazing, certain recommendations have been made which are useful for proper management of forest grasslands such as adopting rotational and controlled grazing.

In Chapter XIII, the soils of the country, their deficiencies and need for fertilising grasslands and legumes are discussed. A good deal

of useful factual data is furnished. The cropping systems for important crops are described and the need for introducing a dual purpose legume fodder/green manure, in the rotation system is stressed both for increased production of fodder and maintenance of soil fertility.

Mixed farming and its significance so far as our country is concerned is also discussed and ley farming is suggested to be tested in India.

Breeding work on legumes and grasses to evolve a high-yielding vigorous grass which can withstand grazing conditions and to evolve a legume of short duration which can conveniently fit into the cropping system under progress in several Research Stations, is referred to in Chapter XIV.

The agrarian structure of the country is described and the low average holding is stated to be one of the reasons for poor maintenance of livestock.

In the last chapter a description of the important exotic and indigenous grasses and legumes, their utility, suitability and distribution is furnished.

The noteworthy feature of the monograph is the abundant factual data presented to substantiate the statements. The monograph will be a very useful reference book for the agrostologist, forester, animal husbandry man and the agronomist. The book will be a useful base of reference in any future planning of the development of fodder resources of India.

K. S. KRISHNA SASTRY.

#### Books Received

*Utilization of Primary Energy in India.* (Occasional Papers, No. 3.) (National Council of Applied Economic Research, New Delhi.) (Asia Publishing House, Bombay-1), 1958. Pp. 70. Price Rs. 5.75.

*How Television Works.* By W. A. Holm. [Philips Technical Library, Eindhoven, Netherlands; India: Philips (India), Ltd., 221, D. N. Road, Bombay-1]. 1958. Pp. xv + 318. Price Rs. 18-94.

*An Atlas of Air-Borne Pollen Grains.* By H. A. Hyde and K. F. Adams. (Macmillan & Co., St. Martin's Street, London, W.C. 2), 1958. Pp. xvi + 111. Price 36 sh.

*The Strategy of the Chemotherapy* (The Eighth Symposium of the Society for General Microbiology.) Edited by S. T. Cowan and E. Rowatt. (Cambridge University Press, London, N.W. 1), 1958. Pp. viii + 360. Price 35 sh.

---

---

**SCIENCE NOTES AND NEWS**

---

---

**Direct Observation of Weiss Domains**

By cooling a nearly eutectic melt, large plate-like single crystals of the hexagonal compound  $\text{BaFe}_{12}\text{O}_{19}$ , the main constituent of ferroxdure, can be obtained. In this process, now in use for some years in the Philips Research Laboratories, extremely thin crystal plates may be obtained under certain conditions. Their thickness is less than a micron and their surface area of the order of one square millimetre. X-ray diffraction photographs of these tiny platelets have shown that they too are single crystals of  $\text{BaFe}_{12}\text{O}_{19}$ , with the hexagonal axis perpendicular to the flat surface.

The special interest of these platelets is that they are reasonably transparent to red light. The transparency of the platelets opens up an elegant method for the direct observation of the Weiss domains in  $\text{BaFe}_{12}\text{O}_{19}$ . The platelet is observed in a polarising microscope with nearly-crossed nicols.

In each Weiss domain in a ferromagnetic material, the magnetic moments of the atoms or ions are aligned parallel, so that in each domain the saturation magnetization exists. The direction of magnetization, which depends on the crystal-shape or stress-anisotropy, differs from one Weiss domain to another. In  $\text{BaFe}_{12}\text{O}_{19}$ , the direction of the magnetization is entirely determined by the very large crystal anisotropy; the preferred direction of magnetization is here the hexagonal axis (*c*-axis). In the crystal platelets, therefore, the magnetization of all Weiss domains is perpendicular to the flat surface, in spite of the high demagnetization factor of the plate form. The Weiss domains are thus magnetized, with the domain walls all perpendicular to the flat surface. Because the magnetization is so strongly bound to the hexagonal axis in  $\text{BaFe}_{12}\text{O}_{19}$ , no "closing" domains occur at the surface (i.e., Weiss domains with magnetization parallel to the surface), in contrast with the usual situation in other materials.

If a beam of plane-polarized light is now projected parallel to the hexagonal axis on to such a platelet, a Faraday rotation occurs, of magnitude and sign dependent on the magnetization. Suppose that for one domain, the plane of polarization undergoes a rotation described by a right-handed screw; the light passing through an adjacent domain, owing to the oppo-

sitely-directed magnetization, will then undergo an equal rotation of its plane of polarization in the opposite direction, i.e., corresponding to a left-handed screw. An analysing nicol is placed in the emerging beam. By placing this not exactly perpendicular to the plane of polarization of the incident beam, the intensity of the rays passing through adjacent, oppositely-magnetized domains will differ slightly; in this way the whole domain pattern becomes visible.

**A Transistor Thyatron**

An important new device recently made available by the General Electric Company of America is the silicon 'Unijunction' transistor, which is a semi-conductor equivalent of the controlled grid thyatron. It is a three-terminal device, hermetically sealed, with a stable *n*-type negative resistance characteristic over a wide range of temperature. The *n*-type silicon bar is mounted between two ohmic base contacts with a *p*-type emitter near the second base contact. The high peak-current rating makes the device useful in medium power switching and oscillator applications, where it can serve the purpose of two conventional silicon transistors. Some of the applications for which the 'Unijunction' transistor is particularly recommended are saw-tooth generators, pulse generators, pulse-rate modulators, pulse amplifiers, multivibrators, flip-flops and time-delay circuits.

**Cleaning of Glass by Ionic Bombardment**

It has been found repeatedly that a glass surface facing a pure aluminium cathode gradually develops a hard and optically absorbing deposit on its exposed surface as the bombardment progresses. The rate of formation of the discoloured layer is greatest when the glass is within the cathode dark space. Glasses immersed in a glow discharge with the cathode electrode shielded from the glass surface, may be cleaned without developing a light-absorbing coating.

Further experiments have established that clean glass surfaces may be produced if the electrons leaving the cathode are made to travel in directions which avoid collision with the work surface while the positive ions are scattered by gas molecules and strike the work. Using this system, clean glass surfaces have



been produced in both argon and air, suggesting that a mechanical rather than a chemical process is responsible for cleaning.

It is concluded that electrons formed in a glow discharge decompose hydrocarbon molecules absorbed on surfaces which they strike, whereas positive-ion bombardment removes surface contaminants from glass and at high current-densities may remove components from the glass. Furthermore, clean surface may be prepared in the presence of hydrocarbons providing the electron bombardment is reduced in preference to ion bombardment.

### Krypton-85 and Diagnosis of Heart Disease

Research at the Public Health Service's National Institutes of Health has shown that krypton-85, a radioactive form of a harmless inert gas, can be used to detect abnormal openings in the wall of muscle dividing the right and left chambers of the heart. Left to right "shunts" of blood which result from defects in the partition of the heart are the commonest form of congenital heart disease. Accurate knowledge of the presence and location of these defects is essential for corrective surgery.

The new diagnostic technique was developed by Research Surgeon Richard Sanders, a staff member of the Clinic of Surgery of the National Heart Institute. The discovery was announced in the January issue of the *Proceedings of the Society for Experimental Biology and Medicine*.

### Safety in Radiology

Radiation will reduce the life-span of experimental animals, though there is no evidence that doses comparable to those used in diagnostic radiology have any such influence. Radiation can cause leukæmia in animals, and evidence from several sources—a study of the causes of death of American radiologists, and follow-up of Japanese survivors of atomic bombing and of patients given radiotherapy for ankylosing spondylitis—leaves little doubt that irradiation is a cause of leukæmia in man.

Apart from accidents resulting in gross over-exposure, the most important potential danger of diagnostic X-rays is the production of mutations. X-rays are known to cause mutations in experimental animals and in plants, and there is little doubt that they can cause them in man. Future generations may therefore be affected by mutations induced by irradiation of patient's gonads.

Precautions should be combined with the use of filters, the fastest films and intensifying

screens, and the highest kilovoltage that will yield films of adequate quality for that particular examination. If possible the gonads should be directly protected by lead, in the male whenever they might be in the direct beam of radiation or when they are close to the edge of the primary beam. Protection of the ovaries when they are in the direct beam is rarely possible. It is of the utmost importance to keep the edge of the beam as far away from the testes or ovaries as possible; the dose falls off considerably with every inch of increased distance between them and the edge of the beam.—(*British Medical Journal*, No. 5082, May 31, 1958.)

### Wear

The new international journal, *Wear*, has now been appearing for almost a full year. It is published bi-monthly under the trilingual editorship of Dr. G. Salomon, of Delft (subscription price: 107 sh. 6d.; \$15; 57 Dutch florins per volume, comprising six issues) (approximately 500 pages). (Amsterdam: Elsevier Publishing Co., 1957.) *Wear* is nominally devoted to "fundamentals of friction, lubrication, wear and their control in industry". It is naturally difficult to prevent such a publication becoming narrow and over-specialized and (for a periodical dealing with themes so close to practical affairs) overburdened with technological details. The Journal has successfully avoided this tendency, and the articles are of wide interest and of sober scientific value. Two features of particular value are the participation of Russian scientists, and a systematic abstract of current literature at the end of each issue together with details of current international conferences.

### Bonding of Bone Fracture with Plastics

Ethoxyline resins have been used successfully in bonding fractured bones in live sheep. These adhesives have proved non-toxic, and microscopically new bone has grown freely through and around the plastic. The affected animals have been able to run about within 2 days, and the fractured limbs have clinically united within 10 days without any plaster casts or supports.

### Nomenclature of Cell Strains

At the International Tissue Culture Meeting, held in Glasgow, Scotland, last summer, the subject of the nomenclature of cell-strains used in tissue culture was considered and a Study Committee was appointed that made various recommendations. It was suggested that the

following information be given when first mention of a cell strain is given in a publication: (i) whether the tissue of origin was normal or neoplastic and, if neoplastic, whether benign or malignant; (ii) whether the tissue was adult or embryonic; (iii) animal species of origin; (iv) organ of origin; (v) the cell type (if known); (vi) the designation of the strain; (vii) whether the strain has been cloned and, if so, the clone number; and (viii) the reference to the original article in which the strain was described. It was further suggested that the designation of the strain should consist of a series of not more than four letters indicating the laboratory of origin, followed by a series of numbers indicating the strain.

### Carmine

This compound, which was first described as a reagent for the detection of boron by Zorkin in 1936, has recently been recommended for the absorptiometric determination of small amounts of boron. It has been found that it is in many ways more satisfactory for this purpose than some of the better known reagents.

Carmine is a calcium-aluminium compound of carminic acid, obtained from cochineal. Carminic acid is the effective reactant with borate but carmine is used in preference to the free acid because it is cheaper and does not deliquesce.

The reagent is a bright red powder soluble in water, alcohol, sulphuric acid and sodium hydroxide solution. An aqueous solution of carminic acid is yellow at pH 4.8 and magenta at pH 6.2, but with carmine the colour change is not so well marked.

The reaction of boric acid with carmine, as with other anthra-quinone-based dyes, takes place only in concentrated sulphuric acid solution. A solution of carmine in sulphuric acid changes from orange-red to violet on the addition of boric acid.

### Symposium on Cottonseeds and Its By-Products

The Regional Research Laboratory, Hyderabad, is organising a Symposium on "Cottonseed and Its By-products" from December 5-7, 1958. The following topics will be discussed: Processing and storage of seed and oil, Agriculture, Agricultural studies in cottonseed, Refining of cottonseed oil, Hydrogenation, Solvent extraction, Fundamental studies, By-products, Standards, Statistics and Marketing data, etc.

Information and details can be had from the Director, Regional Laboratories, Hyderabad-9.

### Symposium on Fungus Diseases in India

It is proposed to hold a "Symposium on Fungus Diseases in India" under the auspices of the School of Tropical Medicine, Calcutta, in the third week of December 1958. The symposium will be divided into the following sections:

Internal Medicine; Paediatrics; Gynaecology and Obstetrics; Dermatology; Surgery; and Medical Mycology.

Papers are invited for the presentation at the Symposium. An abstract of the paper (in duplicate) not exceeding 300 words, should be sent to the Director, School of Tropical Medicine, Calcutta, not later than September 15, 1958, and the full paper (in duplicate) should be sent by November 15, 1958. For any further information and details regarding the Symposium, kindly write to the Director.

### Geological Society of India

A new All-India Scientific Society under the name "Geological Society of India" has been formed with its Headquarters at Bangalore. The Society will devote itself principally to promote the cause of advanced study and research in all branches of Geology, with special reference to India. Among its avowed aims and objects, the publication of a Journal embodying results of outstanding research work done in the country, in the field of geology, will be an important one.

Further particulars regarding the membership of the Society, etc., can be had from the office at "Mines House", Malleswaram, Bangalore-3.

### Geological, Mining and Metallurgical Society of India

A Branch of the above Society was inaugurated at Dehra Dun on 8th May 1958, by Hon. Shri K. D. Malaviya, Minister of Mines and Oil of the Government of India.

Shri A. M. N. Ghosh, Technical Member of the Oil and Natural Gas Commission, is the President and Shri P. V. Dehadrai, Senior Petrologist of the Oil and Natural Gas Commission, is the local Secretary.

### Award of Research Degree

Utkal University has awarded the Ph.D. Degree in Chemistry to the following candidates for their theses indicated against each: Shri Gokulananda Mahapatra, "Chemical and Biological Investigations of Some Thiazole Derivatives"; Shri Shiba N. Mahapatra, "Synthetic Investigations on Terpenes".

# INJECTABLES — Safe and Dependable



A wide range of parenteral preparations for meeting the growing requirements of the Medical Profession are now being processed in our Laboratories. They are made from Standard Chemicals employing double distilled and PYROGEN FREE water. Their containers (Ampoules) undergo rigid neutrality tests before they are selected for use. These Injectables are therefore guaranteed to be absolutely safe and dependable.

*The following are but a few of our well-known Injectables :*

- RETICULIN .. .. . A Potent extract of Liver
- HEXOPURIN .. .. . An urinary Antiseptic
- CALCITOL .. .. . Injectable Calcium Gluconate
- BEVITAMIN .. .. . „ Vitamin B<sub>1</sub>
- CEVITAMIN .. .. . „ Vitamin C
- GLUCOSE SOLN. .. .. . „ Pure Dextrose

**The Mysore Industrial & Testing Laboratory Ltd.**

Malleswaram P.O., Bangalore 3

## Bengal Chemical and Pharmaceutical Works, Ltd.

The Largest Chemical Works in India

*Manufacturers of* Pharmaceutical Drugs, Indigenous Medicines, Perfumery, Toilet and Medicinal Soaps, Surgical Dressings, Sera and Vaccines, Disinfectants, Tar Products, Road Dressing Materials, etc.

Ether, Mineral Acids, Ammonia, Alum, Ferro-Alum, Aluminium Sulphate, Sulphate of Magnesium, Ferri Sulph., Caffeine and various other Pharmaceutical and Research Chemicals.

Surgical sterilizers, Distilled Water Stills, Operation Tables, Instrument Cabinets and other Hospital Accessories.

Chemical Balance, Scientific Apparatus for Laboratories and Schools and Colleges, Gas and Water Cocks for Laboratory use. Gas Plants, Laboratory Furniture and Fittings.

Fire Extinguishers, Printing Inks.

Office: **6, GANESH CHUNDER AVENUE, CALCUTTA-13**

Factories: **CALCUTTA - BOMBAY - KANPUR**

## THE NEW ATLAS OF THE SKIES

**I**n observatories all over the world astronomers are examining excitedly the "pages" of a new sky atlas such as the world has never seen before—a superb map of the heavens which is already revealing secrets of the universe. Undertaken by the National Geographic Society (U.S.A.) and the California Institute of Technology which operates the Mount Palomar Observatory, the atlas is the first section of a giant map of the universe, the result of some seven years of intensive work.

Intriguingly, the results of this intensive study are already posing new queries, while the answers to others seem tantalisingly close.

One special piece of optical equipment—the "Big Schmidt" telescope—has brought reality to the astronomers' dreams by making it possible to photograph the heavens to a hitherto unprecedented depth in space—600 million light years. In reality Big Schmidt is a huge camera, named after its designer Dr. Bernhard Schmidt, a German optical specialist. It has a wide aperture lens measuring 48" across and a reflecting mirror of 72". It is a superb camera, penetrating with high fidelity ten times deeper into the heavens and covering a space volume a thousand times greater than any previous attempts, to chart the skies photographically. These qualities enable it to take pictures of hitherto unknown sharpness and clarity at enormous distances. A "light-year" is the distance light travels in one year—roughly six million million miles. The Big Schmidt can

Originally, this telescope was not designed specifically as a "camera" but rather as a "scouting instrument" for the 200" Hale telescope at Palomar Observatory. But in the Sky Survey it was soon found that the 48" Big Schmidt was of paramount importance. With its wide angle reflector, its telescope "eye" recorded on supersensitive film all visible objects in great cone-shaped slices of space, reaching out to an average distance of 2,000 billion billion miles. It accomplished in a few years a task for which the 200" Hale telescope would have needed 10,000 years or so, though the latter "sees" about three times as far.

### EXPLODING STARS FAR BRIGHTER THAN THE SUN

Yet the Hale is vital too, for when the Big Schmidt discovers some unusual phenomena, they are studied intensively by the Hale telescope. The immense scope of the work may be better visualized when it is known that the new sky atlas will keep astronomers all over the world busy studying the results for an estimated period of 50 to 100 years.

When conditions are suitable, the Big Schmidt goes into action, but even then it is possible to obtain (usually) only four matching pairs of red and blue photographic records a night.

Each section of the sky is photographed on 14-inch photographic plates, through red and blue filters. This "double" exposure reveals more clearly, the colour, temperature and brilliance of distant stars, and moreover will enable astronomers to learn more about the "novæ" and "supernovæ"—those stars that suddenly and inexplicably explode and swiftly burn themselves out, and a brightness estimated to be millions of times greater than that of the Sun.

In all, nearly three-quarters of the sky visible from Palomar have been photographed and recorded.

Almost from the beginning of the survey, astounding discoveries have been made. In 1950, for instance, the discovery of two new dwarf stellar systems in the Constellation of Leo was announced. Up to this time, the smallest known galaxies were estimated to possess a diameter of about 3,000 light years; the smallest among the newly discovered is estimated to have a diameter of only 1,500 light years, which suggests that perhaps even smaller stellar systems exist.

### GALAXIES TWO BILLION LIGHT YEARS AWAY

Then, in 1951, came the announcement of a much more startling discovery, namely, that

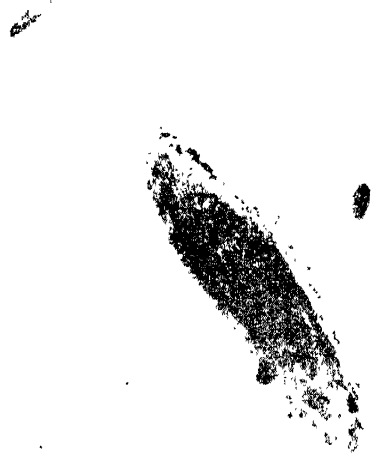

FIG. 1. Andromeda Nebula photographed with the Schmidt telescope. reach out some 600 million light years to obtain its pictures.

there are more than 1,000 clusters of nebulae in the heavens, as compared with the twenty known prior to the survey. These clusters are great masses of stars and gas, some as far as 350 million light years away.



FIG. 2. The 'Big Schmidt' telescope.

But the most revolutionary discovery of all was made by Dr. Walter Baade, early in 1953. Working at Palomar, Dr. Baade found that, contrary to scientific belief, all stellar systems beyond the earth's own galaxy (the Milky Way) are twice as far away as previously believed.

The most distant galaxies visible through the 200" Hale telescope, Dr. Baade discovered, are two billion light years away.

What is the significance of this discovery? The observable universe has a volume eight times as great as believed, while its age is put at four billion years.

Almost daily new aggregations of stars and systems of stars, nebulae like the Milky Way, are discovered. Of the Milky Way itself much new information has been added. In shape it is now seen as a great flat wheel of stars, slowly spinning in space, with "arms" of stars, gas and dust spiralling off its rim.

The foregoing is but a microscopic fragment of new knowledge about the universe which the sky atlas has already revealed. Equivalent in size to about 20 very fat volumes, the completed sky atlas will comprise 1,758 photomaps. The first section of the atlas is in the form of 14-inch unbound prints, totalling about 200 sky charts. Overall cost of one printing and handling only, and omitting all other expenses involved, will be about £ 712 (\$ 2,000) per copy. By 1959, it is planned, all sections of the atlas will have been printed and despatched to the hundred or so observatories which have ordered it.

With its aid, perhaps we shall learn how large creation really is. We may even learn whether the universe is of uniform structure, and whether it had a definite beginning in space and time? Perhaps, also, we may discover whether the universe will end one day, or simply go on extending outward endlessly into space.—UNESCO.

#### ARIZONA METEORITE CRATER

**D**URING the summer of 1956, the Smithsonian Astrophysical Observatory sent an expedition to investigate the distribution of pieces of meteoritic material that are scattered through the mantle of soil surrounding the Arizona Meteorite Crater, the object being to determine more accurately the mass of the meteorite that made the crater and also the direction of its flight.

Estimates of the total mass of finely divided meteoritic material around the crater suggested that this is about 12,000 tons, but this figure is subject to some uncertainty. It is believed that about one-fourth of this mass may be terrestrial oxygen that combined with the meteoric iron after its encounter with the earth. In addition, there does not appear to be any way for ascertaining accurately the amount of con-

taminating material present. After taking into consideration a number of uncertain factors, it is believed that the computed mass of 12,000 tons may have to be reduced by about 10-20%.

It is suggested that the meteorite approached the earth from a south-westerly direction, and after the collision threw forward large quantities of meteoritic material to the position where it now rests. As no piece more massive than 2,000 lb. has ever been found, while thousands of pieces weighing a few ounces or less have been recovered, it is believed that the meteorite was shattered into fragments when it struck the earth, melting and evaporation accompanying this disintegration. The results so far provide no indication as to whether a large mass of meteoritic material lies buried in the crater.

## RELATIVITY AND SPACE-TRAVEL

V. R. TIRUVENKATACHAR

*Defence Science Laboratory, New Delhi*

CAN one keep young by merely taking a round trip to outer space—say, to one of the fixed stars—and back? In other words, can interstellar travel be a recipe for perpetual youth? Fanciful as this question may appear at first sight, it has nevertheless been the object of protracted controversy in the recent scientific literature, owing largely perhaps to the increased interest in space-travel stimulated by progress in rocket—and missile—techniques, which has resulted in the successful launching of artificial earth satellites. While the connection between progress in propulsion techniques and the problem of space-travel is obvious, the effect of space-travel on the age of space-travellers may not be so apparent. The basis for expecting the existence of such an effect is provided by the theory of relativity according to which a moving clock goes slower, in comparison to a fixed one, at a definite rate, depending on its speed (“Einstein time-dilatation”). Thus if, of two otherwise identical observers A and B (“twins”) originally at rest relative to each other, B begins to move away from A at a certain velocity on a spatial voyage and later returns home at the same velocity, his elapsed time as measured by his watch will be less than the elapsed time recorded by A who stayed at home. The returning astronaut would find that his stay-at-home brother had aged faster than himself. The matter was presented in a striking and entertaining way by Gamow.<sup>1</sup> Imagine a trip by B to Sirius and back in a rocket-ship travelling at nearly the speed of light. Assuming that Sirius is about seven light-years distant from the solar system, let us suppose that one fine morning B starts just at 6 A.M. in his rocket-ship and accelerates very rapidly (i.e., in a very short time) to a speed of, say, 99.9999995% of the speed of light. At this speed, reckoned by A’s time, it will take B slightly more than seven years to reach Sirius and A will grow older by fourteen years while he awaits the return of his adventurous brother. Let us call the time required for B to reach Sirius exactly 60,000 hours. Now at the speed we have given B, the Einstein time-dilatation factor (see below) will be very nearly 10,000, so that 10,000 hours of A’s time will correspond to 1 hour of B’s time. According to B’s reckoning, therefore, he will take only 6 hours to reach Sirius, arriving there exactly at

noon. He then swings round and heads back for earth. We shall assume that this acceleration also consumes a negligibly short period of time. The return trip of 60,000 hours will again be recorded as 6 hours by B’s sluggish clock so that in his view, he has returned home at 6 P.M. (again neglecting the final, very short period of deceleration) on the same day. But in the same period (*viz.*, the period of B’s absence from home) A has aged 14 years!

This conclusion of the comparative youth of returning space-travellers was also stated and discussed by Sir George Thomson in his recent book<sup>2</sup>; and it has given rise to a prolonged controversy as to whether or not the existence of such an asymmetry in age between the twins is a legitimate deduction from the postulates of relativity.<sup>3</sup> We are confronted here with a matter of basic principles, quite apart from any possible consequences thereof for homesick astronauts. The difficulty—an old one known as “*the clock paradox*”—will become apparent if we observe that, according to the relativity postulate, B is equally justified in considering himself to be the stay-at-home and A the roving astronaut, so that now A could claim with equal justice that he was the one who should be younger. Who is right? How to decide who travelled and who stayed home? As long as A and B remain in relative motion at a distance apart and do not meet, there is no way of deciding who is right; the question has then no physical content. But if the twins having been originally together, separate and subsequently meet again, the situation is different because ages can be compared directly when the two meet again and the question can be settled without ambiguity. It can, however be shown that there is really no paradox and that, whatever the view-point adopted, the stay-at-home, earth-bound twin will age at a more rapid rate than his wandering twin brother. In the next section we shall summarise the arguments leading to the stated result; in the third section we shall discuss the possible experimental verifications of the result; and in the final section we shall consider the practical implications for space-travel. (See also Macmillan.<sup>4</sup>)

Suppose that A is at rest at the origin of an inertial frame S, while B has the same relation to another inertial frame S’ and that the two

inertial systems S and S' are in relative motion with velocity  $V$  parallel to the  $x$ -axis (in S). We take the  $x'$ -axis in S' parallel to the  $x$ -axis. Let us further suppose that the clocks of A and B are set so that they each read zero when the two origins coincide, which defines the epoch of the beginning of the trip. The coordinates and the times in the two systems are then related by the Lorentz transformation:

$$x' = \beta (x - vt)$$

$$t' = \beta \left( t - \frac{vx}{c^2} \right)$$

where

$$\beta = \left( 1 - \frac{v^2}{c^2} \right)^{-1/2}$$

Suppose that at a certain instant a clock at  $x = 0$  in S indicates a time  $t$ . Then a clock in S' at A's location (i.e., a clock which coincided with A's clock at the instant in question) will indicate a time

$$t' = \beta t.$$

Reciprocally, if a clock in S' at B's location ( $x' = 0$ ) indicates a reading  $t'$  then a clock in S at the same location  $x = 0$  will indicate a time

$$t = \beta t'.$$

This is of course "the Einstein time-dilatation"; relative to either system (regarded as "at rest"), clocks in the other system (regarded as "moving") will go slow. Returning to our problem of the twins, let us suppose that B moves with uniform velocity  $V$  relative to A except at the beginning, middle and end of the journey, when he is either accelerated or decelerated. We further suppose that the time-interval  $T$  (by A's clock) during which B is moving with uniform velocity is so large that the periods of acceleration and decelerations are negligible in comparison. The total time  $\Delta T_A$  for the complete trip will be, according to A,  $2T$ . On the other hand, according to B (who considers himself to be at rest and A to be in motion) the time occupied is by the above formula

$$\frac{2T}{\beta} = \frac{1}{\beta} \Delta T_A$$

which is less than  $\Delta T_A$ . There will thus be an unambiguous difference between the two results. Objection has been taken to this conclusion on the ground that this is incompatible with the relativity of all motion which, it is claimed, demands complete symmetry between the experiences of A and B. This cannot be admitted; for, as pointed out by McCrea,<sup>5</sup> the world-line of the observer on

the earth is a geodesic while that of the traveller is not a geodesic (though it can be made up of parts of four different geodesics). This distinction between the two observers is an absolute distinction. (See also Eddington.<sup>6</sup> Eddington points out that the physical disturbance experienced by B is not uniquely related to the co-ordinate acceleration, which is purely relative.) This absolute distinction results in a distinction between the ways in which the two observers describe the relative journey. Moreover, when we take into account the accelerations which are necessary if the twins are to start and end with no separation in space and no relative velocity, we must take into consideration not only the relative motion of the twins but also of the rest of the universe. If B is to stand still and the earth, Sirius and the rest of the universe are to be accelerated to such a speed that for seven years Sirius is approaching B and the earth is receding, followed by the opposite motion of the universe during the next seven years, then the problem should properly be treated on the basis of the general theory of relativity. It is then found that on either point of view, the twin A who remains at home will age at the usual rate, while B will age at the less rapid rate as given above. This was pointed out many years ago by Tolman,<sup>7</sup> who gave a complete solution of the problem. We reproduce here the substance of Tolman's derivation. (See also Frye and Brigham.<sup>8</sup>) Suppose B is considered to be at rest while A and the rest of the universe are supposed to have the sequence of motions exactly opposite to that of B in A's description. In order to arrive at a description which shall be valid from either point of view, we may assume that changes in the relative motion of A and B are brought about by the temporary introduction of homogeneous gravitational fields which are allowed to act on A in such a way as to produce the desired changes in velocity. For the two time-periods  $\Delta t_A$ ,  $\Delta t_B$  as given by A and B, we may write

$$\Delta t_A = t_A + t_A' + t_A'' + t_A'''$$

$$\Delta t_B = t_B + t_B' + t_B'' + t_B'''$$

where  $t_A$ ,  $t_B$  are the time-intervals (according to A and B) during which A is now regarded as having a uniform velocity  $v$ , and  $t_A'$ ,  $t_A''$ ,  $t_A'''$  and  $t_B'$ ,  $t_B''$ ,  $t_B'''$  are the times needed for the three changes in velocity of A which are brought about in the beginning, middle and end of the journey by the temporary introduction of gravitational fields. As mentioned earlier, we can take these latter intervals to be

very short, compared with the time-interval during which A is in uniform motion. We further suppose that  $v \ll c$ . Since the clock A is the one now in motion, we have in the first place

$$t_A \approx t_n \left( 1 - \frac{1}{2} \frac{v^2}{c^2} + \dots \right)$$

When the gravitational fields are introduced at the beginning and end, the two observers are at practically the same potential, so that

$$t_A' \approx t_n', \quad t_A''' \approx t_n''''.$$

On the other hand, when the gravitational field is introduced at the middle of the journey to produce the necessary reversal of A's motion, the two observers will be at a great distance from each other and in this case, on account of the difference in gravitational potential ( $\Delta\psi$ ), we must write

$$t_A'' = t_n'' \left( 1 + \frac{\Delta\psi}{c^2} \right).$$

Here  $\Delta\psi = gh$ , where  $h$  is the distance between A and B; further,

$$g \approx \frac{2v}{t_n''}$$

and

$$h \approx \frac{1}{2} vt_n''$$

so that

$$t_A'' = t_n'' + t_n'' \cdot \frac{v^2}{c^2}.$$

Thus finally

$$\begin{aligned} \Delta t_A &= t_n \left( 1 - \frac{1}{2} \frac{v^2}{c^2} + \dots \right) \\ &\quad + t_n' + t_n'' + t_n \cdot \frac{v^2}{c^2} + t_n'''' \\ &= t_n \left( 1 + \frac{1}{2} \frac{v^2}{c^2} + \dots \right) + t_n' + t_n'' + t_n'''' \\ &\quad \Delta t_n + t_n \cdot \frac{v^2}{2c^2} + \dots \\ &\approx \Delta t_n \left( 1 + \frac{v^2}{2c^2} + \dots \right) - (t_n' + t_n'' + t_n''') \\ &\quad \times \left( \frac{v^2}{2c^2} + \dots \right). \end{aligned}$$

On account of the assumed smallness of  $t_n'$ , etc., we may neglect the last term and get the end result

$$\begin{aligned} \Delta t_A &= \Delta t_n \left( 1 + \frac{v^2}{2c^2} + \dots \right) \approx \frac{\Delta t_n}{\sqrt{1 - v^2/c^2}} \\ &= \beta \Delta t_n \end{aligned}$$

which is exactly the result obtained previously by direct application of the special theory of relativity (from A's point of view).

We now turn to possible experimental verifications of the results discussed in the previous paragraph. So far as the Einstein time-dilatation is concerned, this was verified by H. E. Ives<sup>9</sup> in the laboratory by observations on

canal rays. (See also Ives.<sup>10</sup>) More recently, F. S. Crawford<sup>11</sup> has pointed out that measurements on the decay times of decelerated  $\mu$ -mesons can be interpreted as providing proof of the asymmetrical ageing of the twins (here  $\mu$ -mesons). Another test has been proposed by G. R. Isaak<sup>12</sup> using  $\pi$ -mesons describing a circular path in a magnetic field. Isaak points out that if  $N_0$  and  $N_1$  are the numbers of  $\pi$ -mesons at the same point (in the laboratory frame) but separated by one revolution, then  $N_1/N_0$  should have different values according as to whether the time-dilatation is or is not effective and shows that at available energies, fields and radii of orbits, the difference between the two is appreciable, thus verifying the existence of asymmetry.

The discussion in the last paragraphs having demonstrated the factual correctness of the asymmetry in age between the stay-at-home and the returned traveller, we may now ask: how significant is this conclusion from the practical standpoint, especially in view of recent successes in launching earth satellites, which imply the attainment of high velocities? However, even at one quarter of the velocity of light, the change in time-scale is only about 3% and in a round trip to the periphery of the solar system (say, the planet Pluto) which would occupy about 44 hours, the time gained would only be about 80 minutes. The gain would be far less at the more modest speeds attainable now or in the near future. Relativistic time modifications are thus negligible for travel within the solar system. It seems therefore that we have no choice but to concur with Sir George Thomson's conclusion that "whatever the attractions of interstellar travel, perpetual youth is hardly likely to be an important one".

1. Gamow, G., *One, Two, Three... Infinity*, New York, 1947.
2. Thomson, Sir George, *The Foreseeable Future*, Cambridge, 1935.
3. See a series of articles by H. Dingle, W. H. McCrea, F. S. Crawford and others in *Nature* (London), **167**, 177-80.
4. McMillan, E. M., *Science*, 1957, **126** (1270).
5. McCrea, W. H., *Nature* (London), **1956**, **177**.
6. Eddington, A. S., *Mathematical Theory of Relativity*, Cambridge, 1930; Supplementary Note No. 1.
7. Tolman, R. C., *Relativity, Thermodynamics and Cosmology*, Oxford, 1934, 197.
8. Frye, R. M. and Brigham, Virginia, M., *Amer. J. Phys.*, 1957, **25** (8).
9. Ives, H. E., *J. Opt. Soc. Am.*, 1938, **29**.
10. —, *Nature* (London), 1951, **168**.
11. Crawford, F. S., *Ibid.*, 1957, **179**.
12. Isaak, G. R., *Australian J. Phys.*, 1957, **10** (1).



THE SECTOR-VISUAL METHOD OF ELECTRON DIFFRACTION: THE  
MOLECULAR STRUCTURE OF TETRACHLOROETHENE

C. N. RAMACHANDRA RAO\* AND R. L. LIVINGSTON

(Contribution from the Richard B. Wetherill Laboratory of Chemistry, Purdue University)

West Lafayette, Indiana, U.S.A.

RECENTLY, in this laboratory,<sup>1</sup> a comparative study has been made of various methods of electron diffraction for molecular structure determinations. The potentialities of the visual method using sectored patterns have also been studied with several molecules.<sup>2</sup> We have now investigated the molecular structure of tetrachloroethene by the sector-visual method. Since the molecular structure of this molecule has been studied independently by the visual method using non-sectored patterns<sup>3</sup> and by the sector-microphotometer method,<sup>4</sup> it seemed interesting to be able to compare the results of the sector-visual method with those by the other two methods. Of further interest was the carbon-chlorine distance in this molecule in order to test Pauling's proposal<sup>5</sup> regarding the double-bond character of the C-Cl bonds in the chloroethenes.

Tetrachloroethene, obtained by Matheson and Company, was purified by fractional distillation under vacuum before use. Electron diffraction patterns were taken using an  $r^3$ -rotating sector in the new Purdue apparatus.<sup>6</sup> Electrons of wavelength 0.05452 Å were used with Kodak Lantern Slide Medium plates. The photographs were taken at camera distances of 10.19 and 25.04 cm.

A visual intensity curve was obtained, making use of six patterns, three taken at the long camera distance and three at the short camera distance. These sector-visual data extended from  $q = 15$  to  $q = 87$ .

A radial distribution curve was calculated by equation<sup>7</sup>

$$r D(r) \approx \sum_{q=1, 2, 3, \dots}^{q_{\max}} I_m(q) \exp(-bq^2) \frac{\sin \pi qr}{10}$$

using I.B.M. punched cards. The value of  $b$  was chosen so that  $\exp(-bq^2) = 0.1$  at  $q = 90$ . The data for the range  $q = 0$  to  $q = 14$  were supplied from a theoretical curve. The radial distribution curve thus obtained is shown in Fig. 1.

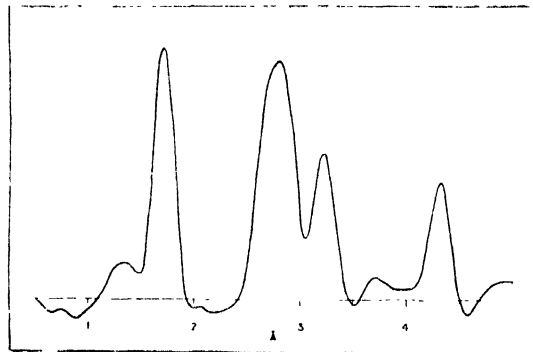

FIG. 1. Radial Distribution Curve for Tetrachloroethene.

The peak positions and the areas of each peak are listed in Table I. Also listed are the approxi-

TABLE I  
Radial distribution results

Distance	Peak Position, Å	$\bar{\Delta} r_{ij}$	Area	$nZ_i Z_j / r_{ij}$
C-C	1.33 <sub>0</sub>	..	17.4	11.4
C-Cl	1.72 <sub>4</sub>	0.05	100	100
C-Cl	2.82	..	159.9	148.9
Cl-Cl (short)		..		
Cl-Cl (intermediate)	3.22 <sub>3</sub>	0.10	64.7	75.9
Cl-Cl (long)	4.32	0.06 <sub>5</sub>	47	56.5

mate mean amplitudes of vibration,  $\bar{\Delta} r_{ij}$ , for some of the peaks; these were obtained using the Karles' method.<sup>8,9</sup> The radial distribution curve shows some negative areas and other extraneous features. No attempt was made to improve the radial distribution curve by performing Fourier inversions on the extraneous features.<sup>2</sup> Experience has indicated that such an improvement would have no appreciable effect on the interatomic distances, but would improve the general appearance of the radial distribution curve.<sup>1,2</sup> There is, however, reasonable agreement of the peak areas with calculated values of  $nZ_i Z_j / r_{ij}$ . No attempt was made to decompose the third peak in the radial

\* Purdue Research Foundation Fellow in Chemistry, 1956-57. Standard Oil Foundation Research Fellow in Chemistry, 1957-58.

distribution curve which is due to a combination of the C-Cl and Cl-Cl (short) distances. The Cl-Cl angle and the C-C distance calculated from the C-Cl, the Cl-Cl (intermediate) and the Cl-Cl (long) distances are  $113^\circ 18'$  and  $1.327 \text{ \AA}$  respectively. This calculated value for the C-C distance does not agree with the position of the C-C peak in the radial distribution curve, because of the small contribution of the carbon atoms to the scattering. The final parameters by the sector-visual radial distribution curve are compared with the results of Lipscomb<sup>1</sup> and Karle and Karle<sup>4</sup> in Table II. The

TABLE II

*Final parameters of tetrachloroethene by the different methods*

Parameter	Visual*	Sector-Visual†	Sector-Micro-photometer‡
C—C ..	$1.34 \pm 0.05 \text{ \AA}$	$1.327 \text{ \AA}$	$1.30 \pm 0.03 \text{ \AA}$
C—Cl ..	$1.71 \pm 0.02 \text{ \AA}$	$1.724 \text{ \AA}$	$1.72 \pm 0.01 \text{ \AA}$
$\angle \text{Cl-Cl}$ ..	$115^\circ 36'$	$113^\circ 18'$	$113^\circ \pm 1.5^\circ$

\* Lipscomb, W. N.<sup>3</sup>

† This research.

‡ Karle, I. L. and Karle, J.<sup>4</sup>

C-Cl distance and the Cl-Cl angle from this investigation agree closely with Karle's results by the sector-microphotometer method and the C-C distance is within the limits of error reported by them.

From Table I it is seen that the mean amplitude of vibration of the *cis* Cl-Cl atom pair is much larger than that of the *trans*-Cl-Cl atom pair. This is probably because the contribution from the modes associated with bending of the

$\angle \text{Cl-Cl}$  is quite appreciable. This is consistent with the spectroscopic information and the earlier observations.<sup>4</sup>

The results of this investigation together with the other results on the chloroethenes<sup>3,10,11</sup> indicate no regular trend in the C-Cl and C-C distances and dispute Pauling's proposal that there is an increase in the C-Cl distances in the chloroethenes as the number of chlorine atoms adjacent to the double-bond is increased.

Work on this and similar compounds indicates that the visual interpretation of sector-diffraction patterns gives results which are considerably more reliable than those obtained by the visual interpretation of non-sector-diffraction plates and only slightly less accurate than can be obtained by the sector-microphotometer method.

- Livingston, R. L., Rac, C. N. R., Kaplan, L. H. and Rocks, L., *Abstracts of the 133rd Meeting, American Chemical Society, San Francisco, California, April 1958.*
- and —, To be published.
- Lipscomb, W. N., as listed by Allen, P. W. and Sutton, L. P., *Acta Cryst.*, 1950, **3**, 46.
- Karle, I. L. and Karle, J., *J. Chem. Phys.*, 1952, **20**, 63.
- Pauling, L., *The Nature of the Chemical Bond*, Cornell University Press, Ithaca, 1940.
- Kristoff, J. J., Jr., *Ph.D. Thesis*, Purdue University, 1958.
- Shaffer, P. A., Schomaker, V. and Pauling, L., *J. Chem. Phys.*, 1946, **14**, 659.
- Karle, J. and Karle, I. L., *Ibid.*, 1949, **17**, 1052.
- and —, *Ibid.*, 1950, **18**, 957.
- Hoffman, C. W. W. and Livingston, R. L., *Abstracts of the 132nd Meeting, American Chemical Society, New York*, September 1957.
- Kaplan, L. H., *Ph.D. Thesis*, Purdue University, 1958.

## ANOMALOUS TRANSMISSION OF X-RAYS BY SINGLE CRYSTAL GERMANIUM

THE anomalous transmission of X-rays through nearly perfect crystals was first observed by Borrmann and Campbell and has been discussed theoretically by Zachariasen, Hirsch and Von Laue. The effect has been measured in calcite by Schwartz and Rogosa and found to agree reasonably well with theory.

Since the anomalous transmission arises because the lattice planes of the crystal coincide with the nodal planes, of the X-ray standing wave field in the crystal, it is clear that any gross lattice imperfections will destroy the effect and even subtle crystal defects will seriously reduce the transmitted intensity. This suggests that the intensity of the anomalously transmitted beam should furnish a sensitive tool for the investigation of crystal perfection. In recent times it has been possible to grow

single crystals of germanium which exhibit a high degree of crystal perfection as indicated by ordinary standards. It was accordingly decided to investigate the anomalous transmission of X-rays by good single crystal germanium, both from the point of view of the effect itself and from the point of view of its use as a tool in the investigation of crystal perfection. In this paper results are given which show how details of the imaginary part of the atomic structure factor of germanium can be measured using essentially perfect germanium crystals and also how sensitive the anomalous transmission is to such crystal defects as dislocations and elastic strain.

(*Proc. Kon. Ned. Akad. Van. Wet. Series B*, Vol. LXI, p. 214.)

## ABNORMAL IONOSPHERIC BEHAVIOUR AT 10 METRES WAVELENGTH

M. KRISHNAMURTHI, G. SIVARAMA SASTRY AND T. SESHAGIRI RAO

*Physical Laboratories, Osmania University, Hyderabad*

**O**BSERVATIONS on the galactic radio radiation at a wavelength of 10 metres are being made in this laboratory (17° 26' N., 78° 27' E.) continuously for the past few months. The experimental set-up consists of a broad-side array of thirty full-wave dipoles connected to a Marconi CR 150/3 type communication receiver, the i.f. output of which is further amplified, rectified and fed to an Esterline Angus recording milliammeter through a d.c. amplifier. The aerial pattern has half power beam-width of about 8° in the east-west direction and about 11° in the north-south direction. At this wavelength, in the tropical regions, it is estimated that the influence of the ionosphere on the intensity of the received radiation will be considerable. Results of the detailed survey at different declinations, now being carried out, will be published elsewhere.

It is the purpose of the present communication to report a very interesting phenomenon observed on three different occasions. It was found that occasionally, for short periods of time, the received radiation intensity falls to zero, the record showing only the noise generated in the receiving circuits. The dates and times at which this phenomenon was observed are given in Table I. Photographs of the actual records are shown in Fig. 1.

TABLE I

No.	Date	Time of Occurrence I.S.T.	Fall Time in min.	Rise time in min.	Duration of minimum noise level in min.
1	28-1-1958	07-10-08-32	35	27	20
2	21-2-1958	06-28-08-05	26	11	60
3	2-3-1958	05-48-07-38	28	23	31

(The Indian Standard Time is 5 hr. 30 m. ahead of G.M.T.)

The main features of this phenomenon are as follows:

(a) It occurs in the early hours of the morning. The starting time seems to be related to the time of sunrise.

(b) The fall in intensity is gradual. The rise in intensity at the end of the phenomenon is uniformly rapid in all three cases. The duration for which the noise level is at a minimum is different on the three occasions.

(c) The minimum noise level in all cases corresponds to the internal noise generated in the receiving circuits.

It is obvious that this enormous decrease in received intensity must be due to total reflection of this radiation by the ionosphere. The occurrence of a solar flare would suggest itself as a possible cause for a violent disturbance in

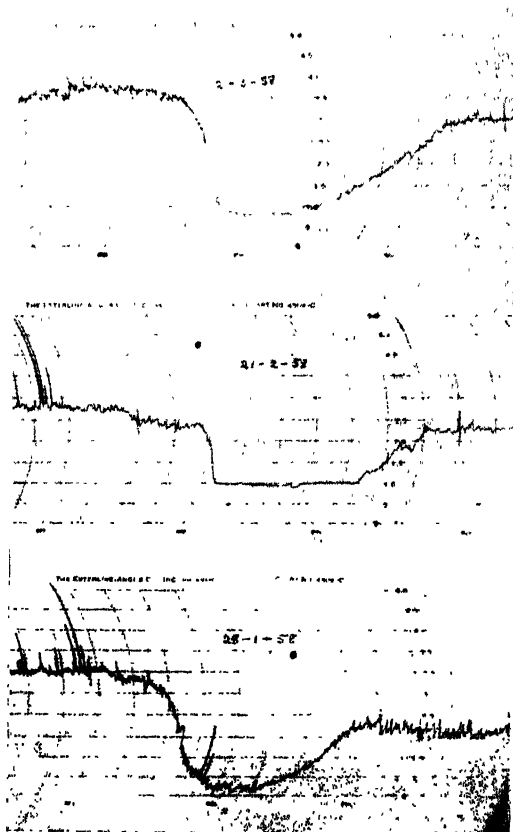

FIG. 1

the ionosphere resulting in the observed total reflection of radiation at this high frequency. A somewhat similar effect at 25 mc/s. was reported by Ramanathan and others (1956) from Ahmedabad at the time of the intense solar flare of February 23, 1956. But in all such effects of a solar flare the beginning is usually abrupt and the end is rather gradual. This is true of the records obtained by Ramanathan (*loc. cit.*). In the present case, however, the beginning is very much more gradual compared with the end of the phenomenon. Besides, neither the Nizamiah Observatory, Hyderabad, nor the Solar Observatory, Kodaikanal, have reported the occurrence of any solar flare about or near this time. So solar flares are

ruled out as the possible cause of this phenomenon observed by the authors. The fact that on all the three occasions, the beginning of the phenomenon is closely connected with the time of sunrise also suggests that it is not due to solar flares. Another point of difference between the Ahmedabad observations and the present work is also of interest. The Ahmedabad workers do not report complete extinction of the cosmic noise as has been observed in the present case.

A possible explanation of the phenomenon might be the presence of a small-scale irregularity in the upper ionospheric layers. Calculation of the electron density necessary to reflect radiation of this high frequency shows that it should be at least ten times more than the normal values for the  $F_2$  layer at this time of the day. If it is assumed that there is such a concentration of matter just before sunrise in these layers, then, as the sun rises above the horizon, the ionisation will gradually increase until the necessary density of electrons is produced to reflect back the cosmic radio waves. Meanwhile, the temperature of this region would be increasing setting up a process of diffusion resulting ultimately in a rapid disappearance of this conglomeration. The magnitude of the initial concentration of atoms and molecules determines the time for which this phenomenon is observed. Thus the density of matter must have been much higher on Febru-

ary 21, 1958, than on the other two occasions. This picture can also explain the reason for the occurrence of this phenomenon in the early hours after sunrise. During the day time, the possibility of finding high concentrations of molecules and atoms is remote. During the night, while such possibility exists, the necessary ionising radiation will not be available to provide the large electron density required.

The use of extra-terrestrial sources of radio radiation for the study of the ionosphere is now well established. But most of the work in this field is being done in temperate regions. The fact that no similar observation has been reported by these workers leads us to believe that this phenomenon may be peculiar to the tropical ionosphere.

#### SUMMARY

Cosmic radio noise observations at a wavelength of 10 metres reveal that ionospheric effects are considerable in the tropical regions even at this wavelength. On three different occasions, total reflection of the cosmic noise was observed, unrelated to any solar phenomenon, but closely connected with the time of sunrise. An explanation based on the assumption of a locally high concentration of matter in the upper ionospheric layers is given.

I. Ramanathan, K. R., Bhonsle, R. V., Kotadia, K. M., and Rastogi, R. G., *Proc. Ind. Acad. Sci.*, 1953, **43 A**, 306.

### LITHIUM DEVELOPMENTS

**A** CENTURY after Bunsen and Matthiessen first prepared lithium metal in sufficient quantity to permit its full examination, this alkali metal and its compounds have been promoted to a prominent place as regards applications in industry.

Lithium carbonate is now regarded as useful in enamels and glazes, as source of lithium chemicals; while the hydroxide is of widest use for conversion to lithium soaps for multi-purpose greases which resist water and weathering, for absorbing carbon dioxide in submarines and confined spaces since it is not deliquescent and does not form a cake of carbonate. In the alkaline storage battery, lithium hydroxide is included with potash to improve capacity. The hydroxide as monohydrate, the carbonate, the fluoride and even powdered lepidolite are all used in lithium glass production where decrease in coefficient of expansion and increase in strength are claims for this inclusion.

Yet lithium has gone much further than in the expansion of such applications first developed some years ago. In the intensive work on ramjet fuels, those hydroborons known as "H.E.F.s" or high-energy fuels, lithium and boron came under close examination in this new project begun a decade ago. Lithium was passed by at first, regarded as too rare for practical purposes; yet the use of lithium hydride for production of hydroborons by reaction with boron halides has brought back lithium into the ramjet field. Even if lithium metal, apart from de-gasification of copper has failed to find a useful role, this appreciation of the hydride, the possibilities of lithium for preparing tritium and of the isotope lithium 7 for control rods in fast reactors, all mark the attention being accorded Arfwedson's metal. Moreover, mere mention of lithium hydride brings up the increasing importance in organic synthesis, and that of lithium aluminium hydride, of lithium alkyls and aryls, of the metal itself in vitamin A synthesis.

## SOME APPLICATIONS OF OXYGEN IN STEEL-MAKING

R. MALLIKARJUNAN

*Indian Institute of Science, Bangalore*

THE detrimental effects of nitrogen on welding, cold-forming and aging of air-blown steel have been recognized in recent years. The pronounced effect of nitrogen on brittleness, particularly brittleness after cold work, has been shown by Work and Enzian.<sup>1</sup> The bessemer steels containing 0.012-0.018% nitrogen have become increasingly inadequate for meeting the more and more rigid specifications. The basic open hearth process can produce low nitrogen steels containing less than 0.005% nitrogen, but this process is not quite economical under the European conditions. It is interesting to note that only an increase of about 0.01% nitrogen in the bessemer steel over the basic open hearth steel necessitated the evolution of a new steel-making process for producing basic open hearth quality steels in Europe.

It had long been known that the steel bath in the converter remained low in nitrogen as long as the carbon content was above 0.5%. By stopping the air blast at some such carbon level and then blowing a mixture of pure oxygen with carbon dioxide or steam in the final step with additions of cold scrap or ore to control the temperature, European steel-makers have made considerable tonnage of low nitrogen Thomas converter steel in the past fifteen years.

The quality of a steel, however, is characterized not only by its nitrogen content but also by the total of other impurities—oxides, slag and gas inclusions. The development of Linde-Frankel process for the production of tonnage oxygen at reasonable cost stimulated the research of Austrian workers for the production of low nitrogen quality steels using pure oxygen for blowing. In 1953, plants were built at Linz and Donawitz in Austria based on the investigations of Rosner, Tenkler and others for making low nitrogen steel with oxygen blowing. This process was at once a success. At least fifteen plants employing this process are now under construction in eight different countries.

This process known as the L.D. Process (Linz-Donawitz process) consists in blowing oxygen at the top of the molten pig iron contained in tuyereless solid bottom converters similar in shape to the conventional converters through a retractable water-cooled copper-tipped lance at a high pressure (100-150 psi) to blow the slag aside and penetrate the metal

beneath. The oxidation of the impurities in the molten pig iron, being highly exothermic, generated very high temperature (2,000-2,500° C.) and is controlled with cold additions of scrap and ore. Unlike the basic bessemer, phosphorus is burned out simultaneously with carbon, and sulphur is reduced to one-third to one-half. Refractory consumption is much less than in bottom blown converters and open-hearth. The steel made contained 0.004% nitrogen with 99.5% pure oxygen blast. The capital cost of the L.D. plant is said to be much less than that of open hearth plant of similar capacity, provided sufficient blast furnace capacity is available.

At present, the L.D. Process produces low nitrogen steel with hot metal containing less than 0.25% phosphorus. In Sweden a rotating top-blown oxygen converter has been developed to produce open hearth quality steel from high phosphorus hot metal.<sup>2</sup> The rotation of the furnace body at a maximum speed of 40 r.p.m. served to bring about intimate mixing of slag and metal, resulting in efficient de-phosphorization. This has been called the Kal Do Process.

The steel experts of West Germany are perfecting yet another steel-producing technique so that up to 2% phosphorus can be removed substantially before the carbon is oxidized completely, thus eliminating the nitrogen pick up in the after-blow period of the basic bessemer.<sup>3</sup> In the Rotor process, as it is called, the hot metal is received in a rotating horizontal cylindrical vessel with a basic lining. The speed of rotation varies between 0.1 to 0.5 r.p.m. The oxygen is introduced in two separate streams—the primary oxygen is introduced beneath the surface of the metal bath through a water-cooled blow-pipe for oxidation of the impurities and stirring the bath, the secondary oxygen stream is directed over the surface of the bath for burning the carbon monoxide evolved during the refining process, resulting in better heat economy. The steel made contains 0.003-0.005% nitrogen and is comparable to open-hearth steel. It is said that the cost of erection of the rotor plant will be 60% of that of the open hearth of equivalent capacity and the cost of production is only 40% of that in open hearth.

It appears that India offers wide scope for the L.D. Process. We have plenty of good

grade ore but our fuel position is alarming. With the success of our five-year plans, our fuel position is likely to become acute in the foreseeable future. Also there is little scrap available in the country because of our low consumption of steel and distance prevents the return of scrap in large quantities to the steel-making centres. Under these circumstances, the L.D. Process is certainly a good competitor to the basic open-hearth process which has been dominating the steel-making show for a very long time. So any planning for increased steel production in our country should certainly

devote serious thought to the L.D. Process. It is reported that part of the steel to be made at Rourekela will be by the L.D. Process.

*Acknowledgement.*—The author is thankful to Prof. A. A. Krishnan, Head of the Department of Metallurgy, for his interest in the preparation of this article.

1. Work, H. K. and Eshian, G. H., *Trans. AIME*, 1945, **162**, 723.
2. Johanson, F., *J. of Metals*, 1957, **9** (7), 972.
3. Graef, R., Dick, W. and Von, L. Bogdandy, *Ibid.*, 1957, **9** (11), 1435.

### INDUSTRIAL RESEARCH AT GENERAL ELECTRIC\*

THE author, a historian, with a special interest in modern science and technology stemming from a war-time association, presents the story of the establishment and growth of the Research Laboratory of the General Electric Company. He employs "the institutional approach" in his study, calculated to arrive at a detailed picture of the organizational and administrative practices of the Laboratory and the pattern of its scientific pursuits and accomplishments. Quite naturally, in this approach, the environment and motivation for the scientific activity get more attention than the actual processes and individual achievements.

At the turn of the present century, the electrical industry as a whole was rapidly approaching the outer limits of its fundamental scientific knowledge. Elihu Thomson, Charles Steinmetz and E. W. Rice, all of the General Electric Company, were the founding fathers of the Research Laboratory, where a band of workers untrammelled by production worries, were to pursue fundamental experimental investigations, search out scientific principles and develop new applications of such principles. From its inception in 1901 to the present day, the Laboratory has been a leading example of the major role of organized industrial research in twentieth century society, and a substantial part of modern electrical technology is the direct outcome of the work of the Laboratory.

Dr. Birr uses his skill as a historian to summarize the many problems and achievements of the Laboratory in its different phases over five decades and a half. The initial fifteen years

were a period of spectacular activity, when under the inspiring leadership of its Director, Willis R. Whitney, a group of scientists, including William D. Coolidge, Irving Langmuir, A. W. Hill, Saul Dushman and W. C. White, made their brilliant contributions, both fundamental and applied, in the fields of incandescent lamps, radio and X-rays, and laid in a firm foundation for a venture in industrial research. After the interregnum of World War I, which diverted attention from the study of fundamental scientific phenomena to the development of anti-submarine devices, night-signalling lamps, detonators, smoke-screens and the like, the Laboratory picked up its main threads again. In this period, extending to the early thirties, the Laboratory, mature but no longer a unique institution and facing severe competition from many quarters, forged steadily ahead, and gave to technology many new ideas, techniques and products. Among such are the sodium vapour lamp, improved neon lamps and photocells, the screen-grid tube, the thyratron, the magnetron and the thoriated tungsten filament; the dynamic loudspeaker and the magnetic pick-up; X-ray tubes based on the cascade principle; high frequency induction heaters; improved types of magnetic sheet steel; new welding processes; new methods of stress analysis of fast-moving shafts and metal parts; new lubricants; the mercury vapour turbine; high temperature corrosion-resistant alloys; cemented tungsten carbide (carboly); and glyptal resins. Then came the depression decade during which the Laboratory, despite very trying conditions, carried on with its earlier interests and also formed new ones. It developed the Betatron, produced a new class of permanent magnet alloys, new organic insulating materials and silicon resins, oils and rubbers, and inves-

\* *Pioneering in Industrial Research—The Story of the General Electric Research Laboratory*, By Kendall Birr. Published by Public Affairs Press, Washington, D.C., 1957, p. 204. Price \$ 4.50.

tigated several problems in powder metallurgy, creep in metals and embrittlement of copper. In 1932, honour and prestige came to the Laboratory with the Nobel Prize awarded to Langmuir for his fundamental work in Surface Chemistry.

Drawn into the war effort during World War II, the Laboratory made a variety of contributions in the fields of electronics and radar, X-rays for metallurgical inspection, silicons, carbon brushes, rocket motors, precision castings, etc.

In the post-war era, to meet challenging conditions created by the problems of financing, personnel procurement, accommodation requirement and an increasingly complex patent situation, the Laboratory has had to reorganize itself in a major way. But the main objective has survived—research, much of it of a fundamental nature. Work in two new areas, experimental meteorology and atomic energy, was inspired by war-time developments. In the latter field, the Laboratory has helped to develop nuclear reactors to power submarines and for commercial atomic power. To aid in fundamental physical research and also for a variety of practical applications, the Laboratory has built Betatrons and Synchrotrons. There has been a massive revival of interest in electronic research, in keeping with the vastly important role of electronic processes in modern technology. Out of the Laboratory have come high frequency tubes, television tubes, ceramic metal seals that presage revolutionary changes in tube design and, above all, semi-conductors. The phenomenon of electro-luminescence has been studied, and light amplification has been achieved. There have been systematic investigations into the theory and practice of metallurgy, crystal growth and nucleation. High temperature alloys, improved ferromagnetic materials, rocket fuels and man-made diamonds

are among the newer products of the Laboratory.

The author points out that a cardinal factor in the growth and functioning of the Laboratory is its continued faith and interest in fundamental, exploratory research, based on a clear recognition of 'the cross-disciplinary nature' of modern scientific activity. According to C. G. Suits, its present Director, "From basic research we achieve what appears to be an answer to a problem; we then search through our complex technology for the problem." The main reasons for the continued success of the Laboratory are not far to seek. The top management of the parent Company genuinely believed in the importance of research. With its broad technical interests, the Company was a kind of a protective giant, using its engineering skill, financial resources and marketing competence to exploit commercially the Laboratory's discoveries. From within, the success was due to the quality of her research scientists, the comparative freedom in which they functioned, the *esprit de corps* and the enlightened leadership, especially in the formative years. The programme of work strove always to strike a balance between development work, some trouble-shooting and a fair amount of fundamental work.

The book is fascinating reading material for the technical as well as the non-technical reader with an interest in industrial research. The author's analysis of the phenomenal success of the Laboratory, in an overall assessment, and his description of the administrative and laboratory procedures and the effective way in which financing, personnel selection and related problems were faced from time to time, deserve the closest attention of those who are in charge of Industrial Research Planning in this country.

S. SAMPATH.

## DECORATION OF DISLOCATIONS

IT has been known for several years that dislocations can be "decorated" by impurity atoms. This is usually done by adding a predetermined quantity of impurities in solid solution, straining and then heat-treating. In metals, two processes are then possible: (i) The diffusion of impurity atoms to the dislocations, producing the so-called "atmospheres", and (ii) the nucleation of precipitates at dislocation sites. Through subsequent etching, the atmospheres

or the precipitates, and thereby the dislocations, can be revealed. This technique makes it possible to investigate dislocation patterns on the original surface as well as in the bulk of the metal, because layers of determined thickness may be removed at will by electrolytic polishing. Since the distance between dislocations may be as small as a few hundred angstroms it is advantageous—and for detailed conclusions even necessary—to examine the specimens with an electron microscope.

LETTERS TO THE EDITOR

SOLUTION STABILITY CONSTANTS OF SOME METAL CHELATES OF *o*-HYDROXY-ACETOPHENONE OXIME

THE values of log.K<sub>i</sub> (concentration constants) of the series of reactions

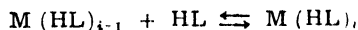

where M stands for a metal ion, HL for the ligand

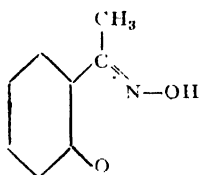

and *i* varies from 1 to 2 or 3 as the case may be, have been measured at 30° C. in a 75% dioxan-25% water medium, by the Calvin-Bjerrum-pH titration method as modified by Irving and Rossotti.<sup>1</sup> The experiments were carried out under an atmosphere of nitrogen using LN-pH Indicator No. 7666 and LN Std. 1199-30 (one black dot) glass electrode in com-

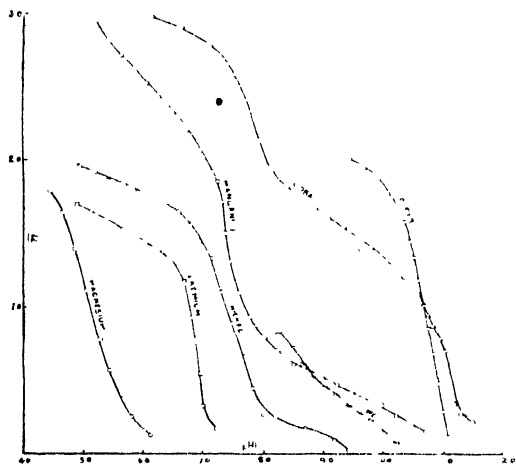

FIG. 1. Formation curves of the metal-ligand systems for metal chelates of *o*-hydroxyacetophenone oxime at 30° C.,  $\mu \sim 0.1$  M and in a medium of 75% dioxan - 25% water.

bination with LN Std. 1199-31 saturated calomel electrode. The concentrations of the metal salt and reagent in the titrated solutions were 0.0005 M and 0.002 M respectively. The solutions contained 0.02 M free HClO<sub>4</sub> and

0.1 M NaClO<sub>4</sub> also, the latter to maintain the ionic strength constant. Measurements were made with sulphates of Mn<sup>++</sup>, Co<sup>++</sup>, Ni<sup>++</sup>, Cd<sup>++</sup>, Zn<sup>++</sup>, Cu<sup>++</sup> and Mg<sup>++</sup>. The relevant formation curves and the log.K values are given in Fig. 1 and Table I respectively.

TABLE I

Metal	log.K <sub>1</sub>	log.K <sub>2</sub>	log.K <sub>3</sub>
Cu	10.15	11.23	..
Ni	7.55	7.25	..
Co	11.20	9.475	7.65
Mn	7.57	7.35	7.13
Zn	8.85	..	..
Cd	6.95	..	..
Mg	5.23	4.97	..

The log.K values show some interesting features. For Cu log.K<sub>2</sub> > log.K<sub>1</sub>. This result can be associated with the formation of the two hydrogen bonds in addition to the metal-electron donor bonds when the second molecule of the ligand is added to the 1:1 complex, if the structure of the final complex is

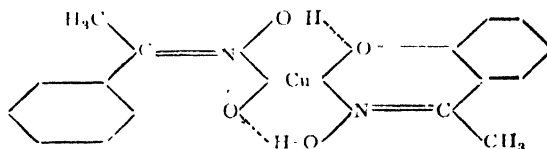

as can be inferred from the known structure of the corresponding copper derivative of salicylaldoxime.<sup>2</sup> The order of log.K<sub>1</sub> values is Co > Cu > Zn > Mn .. Ni > Cd > Mg. The order Cu > Ni > Cd > Mg is that followed by practically all log.K data reported for these metals with other ligands. However, considering only the transition elements studied here, it is seen that their log.K<sub>1</sub> values do not follow the Irving-Williams order.<sup>3</sup> Previous physicochemical investigations on metal chelates of salicylaldoxime lead one to believe that in the systems studied here, there are present some of the factors discussed by Irving and Williams<sup>3</sup> as responsible for the derangement of the order. Thus the possibility of orbital stabilisation, *i.e.*, the use of "inner" orbitals by the metal ions is indicated by the work of Ray and Sen,<sup>2</sup> Cox *et al.*,<sup>4</sup> Kozo Sone<sup>5</sup> and Fujii and Sumitani.<sup>6</sup> In



that case, as is well known, the cobaltous compound would be easily oxidised to the cobaltic state. That  $\bar{n}$  values greater than 2.00 are obtained in the Co titration lends support to this conclusion. Oxidation to the higher valence state and orbital stabilisation would hence explain the very high value of  $\log K_1$  in the case of Co. Similarly since  $\bar{n}$  values up to 3.0 are obtained in the case of Mn, this ion is also oxidised in solution to the manganic state, thus accounting for the relatively higher value of  $\log K_1$ .

The data obtained for Ni are also interesting. If Ni were using the "inner"  $d_{sp^2}$  orbitals to yield a planar chelate molecule,  $\log K_2$  would be expected to be greater than  $\log K_1$  as for Cu. This result is not obtained. Further the formation curve for Ni resembles that for Cd rather than that for Cu, and Cd, as is well known, cannot use any inner orbital in complex formation, it being a non-transition element. It might therefore be possible that Ni is not using the "inner" orbitals under the experimental conditions employed but rather yields a tetrahedral or octahedral complex using "outer" orbitals. Support for this belief arises from the magnetochemical investigations on Ni-bis-salicylaloxime in solvents capable of donating electrons readily such as pyridine.<sup>7</sup> And dioxan can also donate electrons through its two oxygen atoms.

Details of the experimental method and calculations and a fuller discussion of the data will be published elsewhere.

M. B. KABADI.

K. A. VENKATACHALAM.

Physical Chemistry Labs.,  
Institute of Science,  
Bombay-1, March 31, 1958.

1. Irving and Rossotti, *J.C.S.*, 1954, 2904.
2. Ray and Sen, *J.C.S.*, 1948, 25, 473.
3. Irving and Williams, *J.C.S.*, 1953, 3192.
4. Cox, Pinkard, Wardlaw and Webster, *Ibid.*, 1935, 459.
5. Kozo Sone, *J.A.C.S.*, 1953, 75, 5207.
6. Fujii and Sumitani, *C.A.*, 1955, 49, 312.
7. Willis and Mellor, *J.A.C.S.*, 1947, 69, 1237.

### SINTERING OF THORIA

HIGH density thoria bodies have been prepared either by hot pressing at temperatures over 1,700° C. or by cold compacting and sintering at about 1,500° C. with the help of additives. A summary of the results of previous workers is given in Table I.

TABLE I  
Density of sintered thorium oxide

Material	Sintering Temperature °C.	Density g./c.c.	Remarks
ThO <sub>2</sub> +0.5% CaF <sub>2</sub>	1,500	9.6 <sup>1</sup>	} Cold compacting
ThO <sub>2</sub> +0.5% CaO	1,700	9.8 <sup>2</sup>	
Pure ThO <sub>2</sub>	1,500	8.1 <sup>1</sup>	
Pure ThO <sub>2</sub>	1,650	9.0 <sup>3</sup>	} Hot pressing
Pure ThO <sub>2</sub> (from carbonate or oxalate)	1,450	9.0 <sup>3</sup>	

From the above table it will be seen that the maximum density of pure thoria obtained by cold compacting and sintering at 1,500° C. so far reported is only 8.1 g./c.c. (theoretical 10 g./c.c.) and this density can be increased to a figure of 9.6-9.8 with the help of additives. It has been known for sometime that calcining temperature of the oxide has a considerable effect on the characteristics of the powder produced and hence on the sintering behaviour and the object of the present investigation was to see whether it would be possible to get a higher density of the sintered oxide by controlling the calcining temperature.

The starting material was thorium nitrate and the thoria used for the sintering studies was made by (a) direct ignition of thorium nitrate, (b) decomposition of thorium hydroxide (precipitated from thorium nitrate with ammonia), (c) decomposition of thorium carbonate, and (d) decomposition of thorium oxalate.

It was found that the thoria prepared from oxalate gave a higher density than the one prepared from carbonate or the hydroxide (*vide* Table II). During the course of the investigation it was also apparent that the temperature of the precipitation of the oxalate had a significant effect on the properties of the oxide and Table III gives the density of the sintered oxide prepared from the oxalate precipitated under various conditions.

TABLE II  
Sintering of thoria prepared by different methods, calcining temperature 900° C.; compacting pressure 30 tons/sq. in., sintering temperature and time 1,500° C./1 hr.

Material (from which oxide is prepared)	Temperature of precipitation °C.	Density g./c.c.
Thorium hydroxide	30	7.86
Thorium carbonate	30	8.09
Thorium nitrate	..	8.20
Thorium oxalate	30	9.35

TABLE III

Sintering of thoria prepared from thorium oxalate; compacting pressure 30 tons/sq. in., sintering temperature and time 1,500° C./1 hr.

Precipitation temperature °C	Sintered density g./c.c.
10	9.43
20	9.47
30	9.35
35	9.26
40	9.19
50	8.85
60	8.67

Table IV gives the effect of calcining temperature of the oxalate precipitated at different temperatures, on the sintered density (30 tons/sq. in., 1,500° C./1 hr.).

TABLE IV

Density of thorium oxide prepared from thorium oxalate

Temperature of precipitation °C.	Temperature of calcination °C.	Density g./c.c.
20	800	9.11
	900	9.47
	1,000	9.20
30	800	9.26
	900	9.35
	1,000	9.30
35	800	8.95
	900	9.26
	1,000	9.07

From the above tables it will be seen that the oxide prepared from oxalate behaves differently from the other oxides and the maximum density is obtained at the calcination temperature of 900° C. In particular a high density of 9.47 g./c.c. at a sintering temperature of 1,500° C.—the highest recorded so far for pure thoria—was obtained when the oxalate was precipitated at 20° C. and calcined at 900° C. The characteristics of the oxide powders produced by various methods are being studied and the full results of the work will be published elsewhere.

Metallurgy Division, S. K. KANTAN.  
Atomic Energy Establishment, R. V. RAGHAVAN.  
Trombay, April 18, 1958. G. S. TENDOLKAR.

### ULTRASONIC ABSORPTION MEASUREMENTS IN $MgSO_4$ , $ZnSO_4$ , $CoSO_4$ AND $NiSO_4$ AT 3 Mc./Sec.

ACCORDING to classical theory of Stokes, sound waves in liquids suffer an energy loss because of shear forces which causes an absorption coefficient  $\alpha$  proportional to the square of frequency  $\nu$ . The constant ( $\alpha/\nu^2$ ) is given by the shear-viscosity of the liquid. Only few liquids such as mercury, conductivity play an important part in sound absorption. In nearly all liquids, the sound absorption considerably exceeds the classical value, thus indicating that there are some other energies which are causing this sound absorption. The energy losses may be caused by the retarded transition of energy between different degrees of freedom or chemical or structural arrangements of the molecules.

It is known from many measurements that aqueous solutions of many salts, especially 2-2 valent electrolytes, have noticeably higher absorption than pure water. Ultrasonic absorption measurements in electrolytic solutions have been made by a large number of workers. The work has been summarized by Sette.<sup>1</sup> Most of the investigators worked with  $MgSO_4$  because of its high absorption.

In the present investigation ultrasonic absorption in  $MgSO_4$ ,  $ZnSO_4$ ,  $CoSO_4$  and  $NiSO_4$  were made using diffraction method at 3 Mc./sec. at various concentrations. The results for  $MnSO_4$  solution is reported elsewhere.<sup>2,3</sup>

The absorptions are quite large at 3 Mc./sec. hence the measurements can be carried out through progressive wave technique. The optical method is chosen for absorption measurements. The absorption measurements are made using Debye and Scar's technique. Variation in the intensity of the light beam is recorded by means of a DuMont type 6291 photomultiplier tube. Suitable crystal-holders for working in electrolytes have been designed. The crystal-holder designed is long enough to move through long distances and thus very low absorption coefficient can be measured.

The results of the absorption measurements for  $MgSO_4$ ,  $ZnSO_4$ ,  $CoSO_4$  and  $NiSO_4$  at 3 Mc./sec. and 25° C. are as shown in Table I. Results for water is also given in the same table, to show the accuracy of the measurements. The results obtained by other investigators in case of water is shown in Table I for comparison of the results with the present investigations.

1. Arenberg, C. A., Rice, H. H., Schofield, H. Z. and Handwerk, J. H., *Amer. Ceram. Soc. Bull.*, 1957, **36**, 302.
2. Johnson, I. R. and Curtis, C. E., *J. Amer. Ceram. Soc.*, 1954, **37**, 611.
3. Murray, P., Rodgers, E. P. and Williams, A. E., *Trans. Brit. Ceram. Soc.* 1954, **53**, 474.

TABLE I  
( $a/\nu^2$ )  $\times 10^{17}$  sec.<sup>2</sup> cm.<sup>1</sup>

Conc.	0.05	0.1	0.2	0.4	0.6	0.8	1.00
MgSO <sub>4</sub> ..	40	60	100	170	245	280	320
ZnSO <sub>4</sub> ..	50	85	140	200	250	280	320
CoSO <sub>4</sub> ..	55	90	145	220	270	300	340
NiSO <sub>4</sub> ..	35	55	100	160	200	240	280
Water (Author)				..	28		
Water (Other investigators)				..	25-30		

## ACKNOWLEDGEMENT

The author would like to express his sincerest thanks to Dr. G. S. Verma under whose guidance the present investigations were carried out and to C.S.I.R. for the Research Grant. Dept. of Physics, SUSHIL KUMAR KOR. University of Allahabad, Allahabad (India), April 24, 1958.

1. Sette, D., *Nuovo Cimento*, 1949, **6**, 1.
2. Verma, G. S. and Kor, S. K., *Proc. of Physical Society* (London), 1958, **72**, 81.
3. — and —, *J. Chem. Phys.*, 1958, **29**, 9.

### THE RAMAN SPECTRUM OF PYRIDINE N-OXIDE

DURING our studies on molecular structure and chemical reactivity of heterocyclic N-oxides, we had occasion to obtain the Raman spectra of pyridine and substituted pyridine N-oxides. The Raman spectrum of pyridine N-oxide has been recorded for the first time. A Hilger Raman source and a Fuess glass spectrograph have been used.

The Raman frequencies of pyridine N-oxide are given below with the usual convention:

186(1 b), 232(1 b), 520(1), 553(1), 596(2), 624(1), 686(4), 730(1), 767(6), 841(1 b), 989(1), 1017(3), 1050(3), 1104(1), 1157(2 b), 1217(3), 1254  $\pm$  10(3 b), 1382(2), 1509(1), 1558(1) [C=N], 1613(8) [C=C], 1893(2 b), 2034(2), 2100(1), 2233(1), 2495(2), 2826(1), 2874(2), 2918(3), 2954(1), 3046(4), 3086(1).

The band observed in the spectrum of pyridine N-oxide at 1254  $\pm$  10 cm.<sup>-1</sup> is absent in that of pyridine. This band is assigned to the N  $\rightarrow$  O stretching vibration. This assignment is in conformity with the results obtained by Blasina and co-workers<sup>1</sup> [1242 cm.<sup>-1</sup>] and Wiley and Slaymaker<sup>2</sup> [1266 cm.<sup>-1</sup>] from infrared studies.

It is also observed that the double-bond frequencies that are characteristic of pyridine<sup>3</sup>

are altered considerably in pyridine N-oxide. These changes may be explained on the basis of different resonance forms that are possible for pyridine N-oxide.

Details of this investigation along with those relating to the substituted pyridine N-oxides will be published elsewhere.

Chemistry Dept., K. RAMIAH,  
Osmania University, V. R. SRINIVASAN,  
Hyderabad-7,  
April 22, 1958.

1. Blasina *et al.*, *Gazz. Chim. Ital.*, 1955, **85**, 1085.
2. Wiley and Slaymaker, *J.A.C.S.*, 1957, **79**, 2233.
3. Kline and Turkevich, *J. Chem. Phys.*, 1944, **12**, 300.

### RESORCINOL AS A REAGENT FOR THE SPECTROPHOTOMETRIC DETERMINATION OF URANIUM

IN recent years, a number of organic reagents such as dibenzoylmethane,<sup>1</sup> salicylic acid,<sup>2</sup> etc., have been proposed for the colorimetric determination of uranium. Earlier, it was observed by Sienssen<sup>3</sup> that resorcinol produces an orange-red colouration when treated with an uranyl salt. In view of its high solubility in water and easier availability, it was thought that resorcinol might prove as a useful reagent for uranium and an investigation of the system, uranyl acetate and resorcinol, has been made.

Aqueous solutions of uranyl acetate M/40, and resorcinol (M/20), when brought together to interact in different proportions red, to deep red-coloured solutions were obtained which showed appreciable absorption at 400-10 m $\mu$ , depending on the concentration of uranyl ion. There was little change in the optical density of the solutions even after 48 hours and also even after heating to about 60° C. The composition of the product was determined by Job's continuous variation method at 400 m $\mu$ , and was found to be 1:2 between UO<sub>2</sub><sup>+</sup> ion and the reagent. An attempt to determine the composition of the coloured product by conductivity and pH titration methods had failed possibly due to the fact that the compound formed is highly dissociated in solution and that one of the constituents of the product is a free acid:—

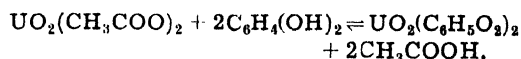

The system obeys Beer's law at the concentration of UO<sub>2</sub><sup>++</sup> ion between 0.125 M  $\times 10^{-3}$  and 1.25 M  $\times 10^{-3}$  and at higher concentrations.

However, there is a deviation at concentrations below  $1.25 M \times 10^{-3}$ . The sensitivity of the reagent is approximately up to  $M/32,000$  (7.43 p.p.m.) of  $UO_2^{+}$  ion, in excess of resorcinol. Most of the common cations and anions interfere with the determination but, a few ions like  $Cl^{-}$ ,  $SO_4^{-2}$ ,  $NO_3^{-}$ , do not interfere unless they are present in large quantities. Detailed results of this investigation will be published later elsewhere.

Our thanks are due to Prof. A. K. Bhattacharya, Head of the Department of Chemistry, for providing facilities for carrying out this work.

Dept. of Chemistry, P. C. JAIN.  
University of Saugar, G. S. RAO.  
April 2, 1958.

1. Yoe *et al.*, *Anal. Chem.*, 1953, **25**, 1200.
2. Muller, *Chem. Ztg.*, 1919, **43**, 739.
3. Sienssen, *Ibid.*, 1912, **36**, 353-54.

### INACTIVATION OF AZOTOBACTER BY HEAT

STUDIES of several workers on the fluctuation of soil nitrogen in different parts of India have shown that there is a well-defined seasonal fluctuation of the same.<sup>1,4,6,8,11</sup> These appear to indicate that there are periods within a year when the nitrogen fixation processes are active in the soil and there are periods when the processes leading to the loss of nitrogen are predominant. High increase in population of nitrogen-fixing microflora in the soil immediately after the soil is moistened by the first rains is one of the noticeable features of some of these studies.

Extreme desiccation of the surface soil and the prevailing high temperature of summer days in Northern India would make nitrogen-fixation by any non-spore-forming mesophil like *Azotobacter* difficult in summer, though recent studies indicate that *Azotobacter* may function in the more moist subsoil or the rhizosphere even under low oxygen pressures and at low organic matter levels.<sup>3,7</sup> Before investigating the effect of high temperatures on *Azotobacter* in soils, it was considered of interest to know the effect of submitting the strains of *Azotobacter* to varying temperatures in culture solutions. The present communication deals with results of some studies carried out on heat resistance of a few strains of *Azotobacter chroococcum* isolated from different Indian soils.

The nitrogen-fixing capacities were determined in Jensen's medium<sup>2</sup> the incubation being carried on for two weeks at 30° C. The results are summarised in Tables I, II and III. In

TABLE I  
*Nitrogen-fixation by Azotobacter chroococcum*  
(mg./g. sucrose) from cultures frozen for  
different days  
(Average of duplicate determinations)

Strain	Days of freezing					
	Initial	2	4	6	14	35
H.P. 1 (i)	11.4	9.2	9.6	8.6	14.0	13.2
H.P. 4 (i)	11.4	12.2	14.2	11.0	11.2	12.0
H.P. 7 (i)	15.0	12.6	14.0	13.4	11.4	14.0
H.P. 9 (i)	14.0	11.2	11.0	10.2	14.6	15.2
K. 13 (iv)	15.0	10.6	12.2	11.4	13.0	15.2
K. 2 (iv)	15.6	14.8	14.4	14.8	15.4	12.4

TABLE II  
*Nitrogen-fixation by Azotobacter chroococcum*  
(mg./g. sucrose) from cultures exposed to  
45° C. for different days  
(Average of duplicate determinations)

Strain	Exposure in days				
	Initial	2	4	6	14
H.P. 1 (i)	11.4	11.4	0.8	1.0	Nil
H.P. 4 (i)	11.4	14.2	11.8	11.6	Nil
H.P. 7 (i)	15.0	15.4	0.6	Nil	Nil
H.P. 9 (i)	14.0	14.0	15.6	Nil	Nil
K. 13 (iv)	15.0	17.4	16.6	14.8	Nil
K. 2 (iv)	15.6	17.0	14.4	12.6	Nil

TABLE III  
*Nitrogen-fixation by Azotobacter chroococcum*  
(mg./g. sucrose) in medium incubated under a  
diurnal variation of temperature at 25° C.  
(Average of duplicate determinations)

Strain	Initial at 30° C.	In cultures incubated at 45° C. for 5 hr. at 32° C. for 16 hr. and at 20° C. for 3 hr.	
		5 hr.	16 hr.
H.P. 1 (i)	11.4	9.2	9.2
H.P. 4 (i)	11.4	9.2	9.2
H.P. 7 (i)	15.0	10.8	9.2
H.P. 9 (i)	14.0	9.2	11.8
K. 13 (iv)	15.6	11.8	13.4
K. 2 (iv)	15.6	13.4	

In Table I are given the nitrogen-fixing capacities of the strains of *Azotobacter chroococcum* frozen for different periods. Table II shows their nitrogen-fixing capacities after they were exposed to 45° C. for different days. Their

nitrogen-fixing capacities in Jensen's medium incubated daily, at 45° C. for 5 hours, at 32° C. for 16 hours and at 20° C. for 3 hours for two weeks (simulating thus temperature conditions obtaining in summer in Northern India) are given in Table III.

The data in Tables I, II and III show that though there may be a temporary depression in the nitrogen-fixation, by *Azotobacter* subjected to freezing for a short period, the general tendency was one of improvement in nitrogen-fixing capacity, notably on prolonged freezing. Its nitrogen-fixing capacity was affected adversely on prolonged exposure to 45° C. and within about two weeks of exposure the organism completely lost its power to fix nitrogen. Microscopic observations showed that it had dissociated into a coccoid form, much diminished in size. It also failed to give raised, opaque and pigmented growth; it grew into a translucent to transparent tough and beaded mass. Different strains of the organism no doubt differed in their resistance to exposure to heat; whereas some strains lost their nitrogen-fixing capacity gradually with increase in exposure to heat in others the loss occurred abruptly. It was, however, interesting to observe that though nitrogen-fixation by the organism diminished when put under a wide diurnal variation in temperature as occurring during summer days in North Indian plains, complete inhibition of nitrogen-fixation did not occur.

The authors' grateful thanks are due to Dr. B. P. Pal, Director, Indian Agricultural Research Institute, for his keen interest in the work.

Indian Agric. Res. Inst.,  
New Delhi, April 21, 1958.

V. ISWAPAN.  
ABHISWAR SEN.

1. Bal, D. V., *Proc. Nat. Inst. Sci. Ind.*, 1937, **3**, 155-61.
2. Datta, S. C. and Dasgupta, B. K., *Proc. 37th Ind. Sci. Cong.*, 1950, 85.
3. Garbosky, A. I., *Proc. 6th Int. Cong. Soil Sci.*, 1956, **3**, 453-60.
4. Iyer, K. R. N., *Proc. 16th Ind. Sci. Cong.*, 1929, 30-31.
5. Jensen, H. I., *Annul. Appld. Biol.*, 1951, **14**, 89-94.
6. Lander, P. F. and Ali, B., *Mem. Dept. Agric. Ind., Bact. Sci.*, 1925, **2**, 1-28.
7. Manteifel, A. Ya and Kozlova, E. I., *Mikrobiologiya*, 1955, **24**, 36-42.
8. Sahasrabudhe, D. I. and Daji, J. A., *Mem. Dept. Agric. Ind. Chem. Sci.*, 1925, **8**, 5.
9. — and Kanitkar, N. V., *Ind. Jour. Agric. Sci.*, 1932, **2**, 455-83.
10. Shah, C. C., Patel, B. M. and Patel, U. R., *Proc. 37th Ind. Sci. Cong.*, 1950, 83.
11. Walton, J. H., *Mem. Dept. Agri. Ind. Bact. Sci.*, 1915, **1**, 97-112.

### A SYNTHESIS OF ISOCHROMENE

ATTEMPTS to prepare isochromene (1H-2-benzopyran) have been so far unsuccessful.<sup>1</sup> It transpired that the compound should be obtainable from isocoumarin according to the scheme given below and this has been carried through.

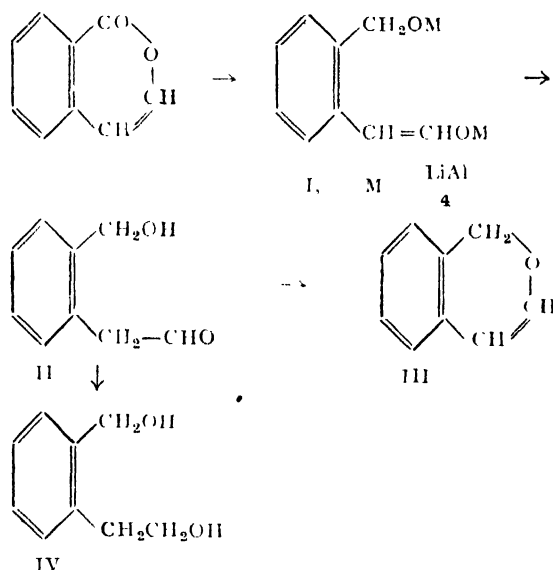

Lithium aluminium hydride (or lithium borohydride) reacts with isocoumarin in ether giving the complex (I) which was hydrolysed to *o*-hydroxymethylphenylacetaldehyde (II, m.p. 76°; 2:4-dinitrophenylhydrazone, m.p. 160°). On further reduction with lithium aluminium hydride, (II) gave the glycol (IV, di-3:5-dinitrobenzoate, m.p. 180°). On treatment with sodium acetate-acetic anhydride, (II) gave isochromene (III, b.p. 140°/115 mm.; m.p. 21.5°;  $n_D^{20}$  1.5818; picrate, orange red needles, m.p. 85°) in good yield. On catalytic reduction this gave isochroman in quantitative yield. Similarly 6:7-dimethoxyisocoumarin<sup>2</sup> has been converted into 6:7-dimethoxyisochromene (m.p. 64°; picrate, chocolate shining needles, m.p. 103°).

The isochromenes deteriorate quickly on keeping.

Science College,

J. N. CHATTERJEA.

Patna-5, April 21, 1958.

1. Maitte, P., *Ann. Chim. (Paris)*, 1954, **9**, 431.
2. Robertson, A., *et al.*, *J. Chem. Soc.*, 1950, 3378

**INFESTATION OF LEATHER  
CRUPPERS BY THE TOBACCO BEETLE  
*LASIODERMA SERRICORNE* FABR.**

AN unusual case of infestation by the tobacco beetle *Lasioderma serricorne* Fabr. of a leather store known as cruppers has been observed. The cruppers (Fig. 1) forms a part of mule

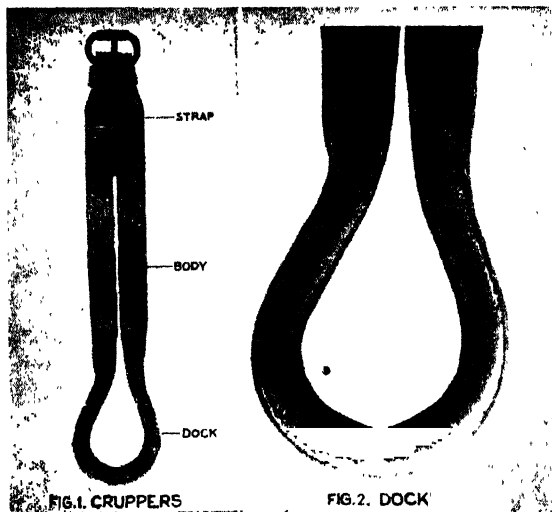

FIG. 1.

FIG. 2.

harness. It consists of a leather body, a strap and a dock. While in use the dock rests underneath the tail of the mule. In order that it remains supple and not cause irritation and injury to the mule, it is stuffed with linseed.

An examination of the infested cruppers revealed that the dock (Fig. 2) had been bored at several places by insects. Inside most of the docks were larvæ, pupæ and adults of *L. serricorne* and the linseed was found in a state of considerable damage. In others, the linseed was additionally infested with the flour beetle, *Tribolium castaneum* H., the *Khapra* beetle, *Trogoderma granarium* Everts., and the carpet beetle, *Attagenus* sp. In both the above types of infestation, it was observed that the inner surface of the docks had been burrowed at several places and in some of the burrows were present either pupæ or full-grown larvæ of *L. serricorne*. It was evident that larvæ of *L. serricorne* were responsible for the damage caused to the cruppers.

Bodkin<sup>1</sup> recorded for the first time the damage of leather by this insect. In the present case it appears that the linseed stuffed in the docks was initially infested with *L. serricorne* and the damage to the docks resulted from the holes made by the larvæ. Inciden-

tally, this appears the first record of linseed being attacked by *L. serricorne*.

It has been found that the treatment of linseed with 5.0% BHC (0.65%  $\gamma$ -BHC) dust at the rate of 2.5 g. per kg. (0.25 lb./100 lb.) of linseed prevents infestation by *L. serricorne*. It has also been ascertained that fumigation of infested cruppers with a mixture of 3 parts of ethylene dichloride and 1 part of carbon tetrachloride (EDCT) at the rate of 560 g. per cubic metre (35 lb./1,000 c.ft.) for a period of 7 days ensures complete disinfestation. Injection of lindane dissolved in rectified spirit into the infested docks did not lead to satisfactory results.

We are grateful to the Head of the Division of Entomology, Indian Agricultural Research Institute, New Delhi, for the identification of the insect as *Lasioderma serricorne* Fabr.

Technical Development	P. S. CHEEMA.
Establishment Labs.,	J. N. MISRA.
Kanpur,	S. I. PERTI.
March 28, 1958.	S. K. RANGANATHAN.

1. Bodkin, G. E., *Ent. Mon. Mag.*, 1919, 55, 264.

**ASCORBIC ACID IN GERMINATING  
SEEDS OF *SESBANIA GRANDIFLORA*  
PERS.**

It has long been known that legumes on germination give rise to vitamin C. On the other hand, cereals, although much richer in carbohydrates, show little evidence of ascorbic acid even after long periods of germination. The question that arises is what would be the ascorbic acid levels at different stages of germination of a protein-rich seed like that of *Sesbania grandiflora*, the protein content of which was reported<sup>1</sup> from these laboratories to be of the order of 70%. Such a question gains, in our opinion, further relevancy in view of our recent observation that the seed contains no starch (absence of colour with iodine), and, if at all, only chromatographically detectable quantities of free sugars. However, acid hydrolysis<sup>2</sup> of the material freed from husk and seed-coat resulted in about 10% reducing sugars. Starch, which is totally absent to start with in the seed, begins to form after 36-42 hours' germination even in the dark, as tested by the blue colour with iodine. With the formation of starch there was no parallel increase in free reducing sugars, but the clear, water extract contained a carbohydrate (presumably sucrose) which, on mild acid hydrolysis, gave rise to free reducing sugars.

We found that *Sesbania* seeds on germination give rise to ascorbic acid in appreciable amounts, as judged by the reduction of a solution of 2:6-dichlorophenolindophenol and further confirmed by identical values obtained for the total ascorbic acid.<sup>3</sup> Typical results for the ascorbic value of *Sesbania* seedlings and comparative values for other legumes are given in Tables I and II; the latter results are close to the values generally reported in the literature for legumes.

The synthesis takes place with equal facility in the dark, under which condition there was no evidence of chlorophyll formation.

Ascorbic acid was more in the radicle than in the cotyledon. This is similar to the results reported by Shaw and Pasco<sup>4</sup> for the broad bean, *Vicia faba*.

Lowered temperatures (ca. 5°) were found to hamper germination and *ergo* biogenesis of ascorbic acid, while both were accelerated at higher temperatures (ca. 37°). We also found

TABLE I  
Increase in ascorbic acid on germination of *Sesbania* seeds (in light)

Period of Germination Hb.	24	48	72	96	120	144	168	192
<i>Sesbania</i>	17.3	49.2	86.0	110.7	165.6	139.4	124.6	128.0
Bengalgram (for comparison)	29.2	43.2	49.9	58.4	75.5	92.3	94.7	115.5

TABLE II  
Ascorbic acid content of *Sesbania* seedlings in comparison with other legumes germinated for the same period

3 Sets of equal weights of seeds soaked for 12 hr. and couched in petri dishes over wet cotton wads and allowed to germinate, all in dark, at room temperature (ca. 25°) for 72 hr. At this stage there was no root hair, no chlorophyll in any of the materials. One set was used for determining dry weight and ascorbic acid estimated by Roe & Kuethers' method<sup>3</sup> in the other 2 sets.

Seed	mg. % ascorbic acid	
	On original seed weight	On dried seedling weight
(Average of closely agreeing duplicate values)		
Agati, <i>Sesbania grandiflora</i>	61.6	75.8
Bengalgram, <i>Cicer arietinum</i>	37.6	41.7
Blackgram, <i>Phaseolus mungo</i>	48.8	60.4
Cowgram, <i>Vigna radiata</i>	45.9	56.8
Field bean, <i>Dolichos lablab</i>	31.8	40.0
Greengram, <i>Phaseolus aureus</i>	64.7	82.4
Redgram, <i>Cajanus cajan</i>	42.7	48.2

Ascorbic acid in *Sesbania* seedlings at comparable ages is 40% more on the seed germinated without the husk and the seed-coat than on the whole seed. This is probably because the seed-coat is extremely hard and does not facilitate absorption of water. This result incidentally suggests that the husk and the seed-coat carbohydrates are not necessary here for the biosynthesis of ascorbic acid, which would appear to stem entirely from the seed proper.

in confirmation of previous reports that these temperature effects are reversed in the case of Bengalgram, *Cicer arietinum*. Sreenivasan and Wandrekar<sup>5</sup> observed complete inhibition of germination at 37° of greengram (*Phaseolus*) also, while pre-treatment in the cold and germination in the dark had beneficial influence on ascorbic acid biogenesis.

Of the effects studied of various additives to the culture medium on the synthesis of ascorbic acid with germination, seeds soaked in 0.05% citric acid solution for 12 hours and then germinated with water, gave a 40% increase in ascorbic acid, at corresponding periods, over the untreated control. Use of citric acid solution at double the concentration (0.1%) for preliminary soaking of the seed did not further increase the ascorbic acid content. Citric acid at either of the two concentrations did not affect the value in Bengalgram. The acquisition of vitamin C potency by certain seeds on soaking them for different periods in citric acid solutions has been reported by Luettmending.<sup>6</sup> We did not find any beneficial effects of Mn<sup>++</sup> (0.1%) on ascorbic acid synthesis in germinating *Sesbania* seeds.

It is significant that among the legumes comparatively studied, *Sesbania* seed with its low carbohydrates and high proteins shows evidence, at comparable periods of germination, of containing more ascorbic acid than any of the other legumes tried (all of them with an average carbohydrate content of 60%<sup>7</sup>), with the exception of greengram.

The ascorbic acid value (total) of *Sesbania* cotyledons or of the radicle immediately after





error limits of each other. But it is not so with respect to the remaining types. It may be concluded, as far as the present study discloses, that Nandi granites, despite their wide variation in lithology and texture, exhibit a general tendency for uniformity in the content of pale yellow and dark brown zircons. A similar line of approach on the study of zircons in other granite bodies in Mysore, understood to be similar in age to Nandi granites, may be of some importance in correlation and genetic studies.

The writer is grateful to Prof. M. R. Srinivasa Rao and Dr. C. Gundu Rao, Department of Geology, Central College, Bangalore, for their valuable suggestions and critical discussion throughout the preparation of this note.

Dept. of Geology, A. ACHUTHARAO,  
Central College,  
Bangalore, May 8, 1958.

1. Achutharao, A., *Curr. Sci.*, 1958, 3, 96.

2. Krumbein, W. C. and Pettijohn, F. J., *Manual of Sedim. Petrography*, p. 472.

### HEAVY MINERALS IN THE CAUVERY RIVER SANDS NEAR TALKAD, MYSORE

IN India, shore and dune sands have been studied in considerable detail, but work on river sands is meagre.<sup>1,2</sup> In this note a description and a quantitative estimation of the heavy minerals in the large sand body associated with Cauvery river (area about 5 sq. miles) near Talkad (Lat. 12° 11' N., Long. 77° 1' E.) are given.

This sand body is pear-shaped, situated in the loop formed by the deep bend of the river. It extends for about 2 miles in a north-south direction with a maximum width of a mile-and-a-half at right angles to it. The western portion close to the river is flat-lying and the eastern, undulating due to the presence of a large number of dunes suggesting that this face of the sand body has witnessed considerable shifting by strong winds. Altogether, 14 samples were collected and each sample sieved, 5 to 10 g of 0.25 mm. fraction passed through Bromoform; the residue quartered and mounted in Canada Balsam on glass slides to have on the average 400 to 800 grains. A microscopical examination of the slides revealed the following minerals: (1) Opaques (magnetite and ilmenite); (2) Hornblende (blue-green) (3) Chlorite; (4) Epidote; (5) Tremolite (6) Pyroxene; (7) Garnet; (8) Kyanite (9) Tourmaline; (10) Zircon; (11) Rutile (12) Sphene; and (13) Apatite. Three hundred grains from each sample were counted on a random basis and the frequency of the different minerals are shown in Table I.

From this table it may be seen that the sand body, despite its fairly large size and a portion of it subjected to shifting by strong winds, shows a remarkable uniformity in heavy mineral assemblage. The significance of this uniformity could only be assessed by the study of similar sands at various points in the up and down stream directions of the river.

Detailed investigations of the several river sands in Mysore, particularly with reference

TABLE I  
Frequency of the heavy minerals in the Cauvery river sands near Talkad

Sample Nos.	Hornblende	Chlorite	Garnet	Pyroxene	Kyanite	Tourmaline	Opaques	Tremolite	Apatite	Epidote	Rutile	Zircon	Sphene	Unknowns
3/A <sub>1</sub>	10	11	5	2	7	6	39	5	1	9	2	1	1	1
3/A <sub>2</sub>	13	11	7	4	5	8	28	10	11	1	1	1	1	2
3/A <sub>3</sub>	15	9	5	5	5	6	27	10	1	12	2	1	1	1
3/A <sub>4</sub>	10	8	10	10	8	5	24	12	2	6	2	1	1	2
3/B <sub>2</sub>	16	17	5	5	11	7	10	10	3	14	1	1	1	2
3/B <sub>3</sub>	19	15	6	6	10	7	19	6	2	7	2	1	1	1
3/B <sub>5</sub>	12	11	8	2	11	11	18	11	1	10	3	1	1	3
3/C <sub>1</sub>	21	12	8	6	7	6	22	5	2	11	1	1	1	1
3/C <sub>2</sub>	25	14	7	6	7	9	9	10	4	6	1	1	1	3
3/C <sub>3</sub>	16	10	4	5	4	7	23	13	1	13	2	1	1	1
3/C <sub>4</sub>	19	17	4	8	7	6	20	8	3	6	2	1	1	1
3/D <sub>1</sub>	22	13	7	5	7	7	14	10	2	9	1	1	1	2
3/D <sub>2</sub>	13	12	5	2	9	11	24	8	5	7	1	1	1	1
3/D <sub>3</sub>	17	14	6	7	7	7	19	9	2	11	1	1	1	1

to their various sedimentological and economic aspects are under progress.

I am indebted to Professor M. R. Srinivasa Rao and Dr. C. Gundu Rao for their guidance and helpful suggestions in the preparation of this note.

Dept. of Geology, C. PARAMASIVIAH.  
Central College,  
Bangalore, May 19, 1958.

- Misra, G. C. and Misra, M. L., "Mineralogical study of Indian River sands," *Q.J.M.U.I. of India*, 1955, 27, (2).
- Roy, A. K., "On the Heavy Mineral Assemblage of Damodar River Sands," *G.S.I. Record*, 1942 77, Professional Paper No. 6.

### OCCURRENCE OF MONAZITE IN THE CHARNOCKITES OF VISAKHAPATNAM

MONAZITE was reported in the beach sands of Visakhapatnam Coast by Mahadevan and Srinamadas<sup>1</sup> and the source for the monazite in the beach sands was traced to the alluvium in the streams flowing in towards the beach and thence to the pegmatites in the area by Mahadevan and Sathapathi.<sup>2</sup> In Padmanabham village, 25 miles north of this area, Srinivasa Sastry<sup>3</sup> reported the occurrence of monazite in the leptynites. The present work shows the existence of monazite not only in the pegmatites and leptynites but also in charnockites.



FIG. 1. Monazite (inside the circle) from Acid Charnockite. Magnification,  $\times 45$ .

The Visakhapatnam area located in between Lat.  $17^{\circ} 42'$  and  $17^{\circ} 45' N.$  and Long.  $83^{\circ} 17'$  and  $83^{\circ} 21' 15'' E.$  consists of khondalites, leptynites, charnockites, granites, pegmatites and quartz-

ites in the order of abundance. In the detailed study of thin sections, monazite was noticed in the acid charnockite, intermediate charnockite, leptynite and pegmatite. The acid charnockite consists of quartz, perthite, oligoclase, hypersthene, magnetite, zircon and monazite. Monazite in contact with magnetite is found as an inclusion in oligoclase. The monazite grain is oval in outline and has dark border due to high refractive index. The garnetiferous acid charnockite contains garnet in addition to the above constituents. The intermediate charnockite contains quartz, perthite, andesine, hypersthene, diopside, biotite, magnetite, apatite and monazite. The leptynite has quartz, perthite plagioclase, garnet and monazite as its constituents. The pegmatite consists of quartz, perthite, biotite, zircon and monazite.

The modal compositions of acid and intermediate charnockites and leptynite were determined and given in Table I.

TABLE I  
Modal composition

	I	II	III	IV	V
Quartz	27.84	26.71	39.86	6.50	40.94
Perthite	49.56	39.69	27.85	5.67	42.84
Oligoclase	12.08	21.15	19.16	39.73	11.31
Hypersthene	2.13	6.48	9.34	12.38	..
Diopside	..	..	..	27.15	..
Garnet	3.97	..	..	..	4.53
Biotite	..	..	..	1.78	0.05
Magnetite	3.60	5.71	3.66	6.59	0.28
Apatite	0.48	..	0.13	0.17	..
Zircon	0.53	0.18	..	..	..
Monazite	0.11	0.08	<0.05	<0.05	0.06

I—Garnetiferous acid charnockite from Visakhapatnam area (Lat.  $17^{\circ} 43' 15''$ —Long.  $83^{\circ} 20'$ ).

II—Acid charnockite from Visakhapatnam area (Lat.  $17^{\circ} 43' 15''$ —Long.  $83^{\circ} 20'$ ).

III—Fine-grained acid charnockite from Visakhapatnam area (Lat.  $17^{\circ} 44'$ —Long.  $83^{\circ} 19' 15''$ ).

IV—Intermediate charnockite from Visakhapatnam area (Lat.  $17^{\circ} 44'$ —Long.  $83^{\circ} 19' 15''$ ).

V—Leptynite from Visakhapatnam area (Lat.  $17^{\circ} 44'$ —Long.  $83^{\circ} 19' 15''$ ).

The modal analysis shows that the monazite is 0.08% in acid charnockite, 0.11% in garnetiferous acid charnockite and <0.05% in fine-grained acid and intermediate charnockites. Leptynite contains 0.05% of monazite. The grain size of the monazite in these rocks varies from 0.04 mm. to 0.21 mm.

Pyroxenes are separated from the other minerals of the charnockites by Frantz Isodynamic separator. They are examined under the microscope to see whether they are free from other minerals. The examination disclosed

monazite along with the pyroxene in the magnetic fraction.

Monazite is usually found in association with zircon. The oval shape, yellowish colour, shining dark borders, high interference colours and biaxial nature of monazite distinguished it from zircon which was found with prismatic faces or prism with pyramidal faces. Another important factor in distinguishing monazite from zircon is that monazite is paramagnetic whereas zircon is diamagnetic.

Among the 40 sections examined, monazite is found more in garnetiferous acid charnockite than the rest of the rocks. Monazite in the intermediate charnockite is less than in the acid charnockite. Monazite from leptynites and pegmatites is also less than in the acid charnockites.

Monazite is associated with quartz and perthite-rich rocks. Among the charnockites, perthitic felspar is abundant in the acid charnockite. In the intermediate charnockite, perthitic felspar is very much less as is the case with monazite. In the basic charnockite both perthite and monazite were not found. So the formation of monazite was facilitated more in the acid charnockites. This observation is supported by the geochemistry of thorium (Goldschmidt<sup>4</sup>).

The large ionic radius of thorium in monazite makes it unfit to enter many of the important orthosilicates or metasilicates of magnesium and divalent iron. So thorium is generally found concentrated in the residual magmas. In the present case the association of monazite with the acid charnockites agrees with this expectation of finding monazite in the residual magmas. Although it is seen in the intermediate charnockites, it is much less abundant showing that the acidity was not enough for the formation of more monazite at that stage.

The author is very much grateful to Dr. A. Sriramadas for his guidance and valuable suggestions, and to Prof. C. Mahadevan for his kind interest. The author also wishes to express his thanks to the Government of India for the award of scholarship.

Dept. of Geology,  
Andhra University,  
Waltair, May 28, 1958.

M. S. MURTY.

1. Mahadevan, C. and Sriramadas, A., *Proc. Ind. Acad. Sci.*, 1948, **27A** (4), 275-78.
2. — and Sathapathi, N., *Curr. Sci.*, 1948, **17**, 297.
3. Srinivasa Sas ry, C., *Ibid.*, 1954, **23**, 151-52.
4. Goldschmidt, V. M., *Geochemistry*, Oxford: at the Clarendon Press, 1954.

### ON A NEW SPECIES OF *PROCAMALLANUS* BAYLIS, 1923 (NEMATODA)

FIVE specimens of *Heteropneustes fossilis* (Day), obtained from local market and examined by me on 20th December, 1957, at Allahabad yielded from their alimentary canal 12 female and 4 male specimens of a new species of the genus *Procamallanus*. The new species is described here under the name *Procamallanus spiculogubernaculus*.

#### DESCRIPTION OF *Procamallanus spiculogubernaculus* n. sp.

(The measurements given are in millimetres.)

*Holotype Male*.—Body:  $3.68 \times 0.088$ , buccal capsule  $0.06 \times 0.036$ , anterior œsophagus  $0.24 \times 0.044$ , posterior œsophagus  $0.3 \times 0.036$ . Nerve ring at 0.12 from anterior end of the body. Tail blunt and conical. Caudal papillæ seven pairs: four pairs pre-cloacal and three pairs post-cloacal. Spicules two, the right long spicule 0.344 long, the left small spicule 0.05 long. Gubernaculum 0.05 long and incompletely fused with the right smaller spicule. Caudal alæ absent.

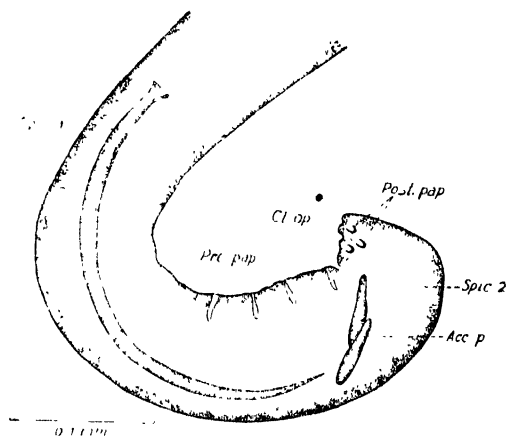

FIG. 1. *Procammallanus spiculogubernaculus*. Tail of male showing important characters. *Acc. p.*, accessory piece; *Cl. op.*, cloacal opening; *Pre. pap.*, pre-cloacal papillæ; *Post. pap.*, post-cloacal papillæ; *Spic. 1*, longer spicule; *Spic. 2*, smaller spicule.

*Holotype Female*.—Body  $4.84 \times 0.088$ , buccal capsule  $0.08 \times 0.048$ , anterior œsophagus  $0.32 \times 0.06$ , posterior œsophagus  $0.46 \times 0.048$ , rectum 0.05 long. Nerve ring at 0.142 and small excretory pore at 0.232 from anterior end of the body. Tail 0.1 long, tapering, pointed, bifid at the tip. Vulva post-equatorial, 2.64 from the anterior end of the body and forming a marked elevation of the body. Vagina 0.608 long.

**Important characters of *Procamallanus spiculogubernaculus*.**—Gubernaculum incompletely fused with the smaller spicule; caudal papillæ 4 + 3 = 7 pairs; vulva post-equatorial; female tail terminally bifid; buccal capsule chitinoid, elongated, barrel-shaped, smooth and undivided; rim of buccal capsule has three lip-like protuberances; caudal and cervical alæ absent; body-size small.

*P. spiculogubernaculus* differs from *P. glosogobii*<sup>4</sup> chiefly in the incomplete fusion of one spicule with the gubernaculum, the caudal papillæ and the position of vulva; from *P. bagarii*<sup>1</sup> chiefly in the fusion of one spicule with the gubernaculum and the structure of buccal capsule; from *P. fulvidraconis*<sup>3</sup> chiefly in the presence of gubernaculum and the structure of buccal capsule; from *P. cearensis*<sup>5</sup> chiefly in its unequal spicules and the structure of buccal capsule; from *P. gubernaculus*<sup>2</sup> chiefly in the number of spicules, the fusion of gubernaculum with one spicule, the number of caudal papillæ and the structure of buccal capsule. From other species of the genus the new species differs very widely, the unique character of the form being the incomplete fusion of right small spicule with gubernaculum.

I am grateful to Dr. S. Khera, D.S.B. Govt College, Naini Tal, for going through the manuscript.

Dept. of Zoology, S. C. AGARWAL.  
University of Allahabad,  
March 10, 1958.

1. Karve, J. N. and Naik, G. G., *J. Univ. Bombay*, 1951, **19 B** (5), 1.
2. Khera, S., *Anales de la Escuela Nacional de Ciencias Biológicas*, 1955, **8** (3-4), 243.
3. Li, H. C., *J. Parasit.*, 1935, **21** (2), 103.
4. Pearce, A. S., *J. Siam. Soc. Nat. Hist.*, 1933, Suppl. **9** (2), 179.
5. Pereira, C. M., Vianna, D. and Azevedo, P. de. *Arch. Inst. Biol.*, 1936, **7**, 209.

### DREDGING AND PHYTOPLANKTON PRODUCTION

It is well known from the investigations of various workers<sup>6-11</sup> that the bottom mud in the sea is rich in regenerated nutrients which are essential raw materials for phytoplankton production. The natural agencies concerned in bringing these nutrients to the surface waters, where photosynthesis takes place, are the different kinds of water movements such as turbulence, upwelling and so on. In fresh-water ponds, where piscicultural operations are carried out, it is a common practice to periodically rake the bottom mud to stimulate plankton

production. In the present instance it is interesting that the churning up of the bottom muds is brought about through an artificial agency, namely, dredging.

While engaged in investigations on the phytoplankton production off Waltair Coast, in 1957, we observed some unusual pulses in the density of phytoplankton populations during periods when normally they are scarce. These pulses appeared sporadically and disappeared as suddenly as they appeared. Previous workers<sup>2,3</sup> from this department have established that off this coast there is a major phytoplankton peak in the March-April period and a minor peak in the months of October and November. The unusual pulses referred to were observed in the month of July when normally the phytoplankton numbers are very low as judged from the data for the previous years. It was also observed that these pulses immediately followed an extensive discolouration of the inshore waters owing to the discharge of large quantities of dredged material near the entrance channel of the Harbour.

The samples of water and plankton were collected from a fixed location in the Lawson's Bay, which is about 5 miles from the entrance channel of the Harbour. Standard techniques were adopted for the estimation of phosphates<sup>1,2</sup> and silicates.<sup>1,3</sup> The phytoplankton production was measured by adopting the pigment extraction method of Harvey<sup>5</sup> and also by measuring the photosynthetic activity using Gran's method.<sup>1</sup> The turbidity was measured with a Hellige Turbidometer. For comparison, the data for the same month in 1956 have also been given in the table as well as in the graph.

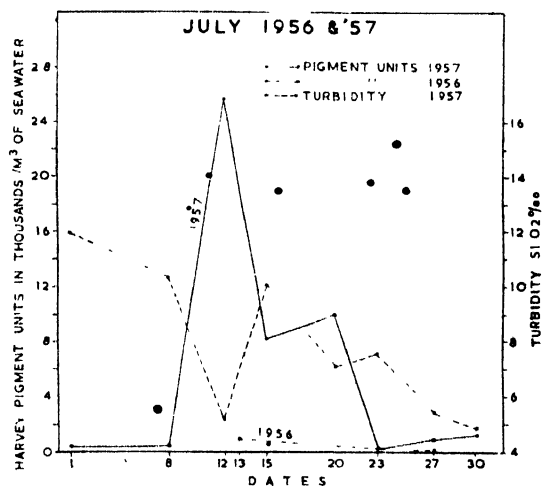

FIG. 1

TABLE I

July Dates	Turbidity SiO <sub>2</sub> $\frac{\mu\text{g}}{\text{L.}}$		Inorganic phosphates $\mu\text{g at/L.}$		Silicates $\mu\text{g. at/L.}$		Pigments H.U./M <sup>3</sup> S. W.		Photo synthesis O <sub>2</sub> ml./L./ 6 hrs. exposure 1957
	1957	1956	1957	1956	1957	1956	1957		
1	15.90	..	1.20	..	16.20	..	403.75	0.488	
5	..	0.87	..	12.8	..	..	..	..	
8	12.70	..	0.31	..	20.90	..	415.63	0.471	
12	2.35	..	0.63	..	20.31	..	2532.0	1.866	
13	..	..	..	..	..	975.0	..	..	
15	12.10	..	1.61	..	20.90	..	4156.25	0.586	
19	..	0.74	..	11.8	..	..	..	..	
20	6.20	..	1.73	..	23.70	..	10000.0	0.693	
23	7.10	0.75	1.78	12.4	15.90	178.75	195.50	0.441	
27	2.85	0.74	2.36	8.84	18.10	84.37	948.75	0.499	
30	1.70	0.73	0.40	12.3	7.50	..	1128.75	0.499	

\* Data on turbidity and photosynthesis are not available for July, 1956.

It will be seen from the data presented that the two steep rises in pigment values are on dates immediately following the days when the water was highly turbid. The turbidity in its turn was proportional to the amount of dredged material hopped into the sea. The photosynthetic activity as measured by oxygen production<sup>†</sup> had also a close correlation with the density of the phytoplankton.

Detailed investigations on the chemical composition of the dredged mud and its probable influence on the productivity of plankton are being continued.

It gives us great pleasure to extend our grateful thanks to Sri. P. V. Appa Rao, A.F.D., Vizag Port, and the officers of S.D. "Vizagapatnam" for evincing keen interest in the work and for affording facilities in collecting our data. One of us (D. V. S.) is also indebted to the C.S.I.R. for the award of a Research Fellowship during the tenure of which the present work was undertaken.

Dept. of Zoology, P. N. GANAPATI.  
Andhra University, D. V. SUBBA RAO.  
Waltair, March 14, 1958.

1. Borrard, T., *Proc. Internat. Assoc. Theo. and Appl. Limnol.*, 1955, **12**, 811-13.
2. Ganapati, P. N. and Murty, V. S. R., *Ind. Jour. Fish.*, 1955, **2** (1), 84-95.
3. — and Subba Rao, D. V., *Curr. Sci.*, 1957, **26**, 347-48.
4. Gran, H. H., *Jour. du Conn.*, 1932, **7** (3), 343-58.
5. Harvey, H. W., *Jour. Mar. Biol. Assoc. U.K.*, 1934, **19**, 761-73.
6. Moore, H. B., *Ibid.*, 1930, **16** (2), 595-607.
7. —, *Ibid.*, 1931, **17** (2), 325-58.
8. Mortimer, C. H., *Jour. Ecol.*, 1942, **29**, 147-201.
9. Rochford, D. J., *Aust. Jour. Mar. and Freshwater Res.*, 1951, **2** (1), 1-116.
10. Seshappa, G., *Nature*, 1953, **171**, 526-28.

11. Stephenson, W., *Jour. Mar. Biol. Assoc. U.K.*, 1949, **28** (2), 371-80.
12. Robinson, R. J. and Thompson, T. G., *Jour. Mar. Res.*, 1948, **7**, 33-39.
13. — and —, *Ibid.*, 1948, **7**, 49-55.
14. Sverdrup, H. U., Johnson, M. W. and Richard, H. Fleming, *The Oceans*. Prentice Hall, N.Y., 1942 1-1087.
15. Walton Smith, F. G., Williams, R. H. and Davis C. C., *Ecology*, 1950, **31** (1), 119-46.

### NEUROSECRETORY CELLS OF THE BRAIN OF THE LEECH *HIRUDINARIA GRANULOSA* (SAV.)

WHILE considerable information is available on the neurosecretory cells and their physiology in Arthropoda and Vertebrata, comparatively very little is known about those of Annelida. The few Annelidan forms that have been investigated are mainly Polychaeta<sup>1-3</sup>; so far only one work refers to the presence of neurosecretory cells in the leech *Hirudo medicinalis*.<sup>4</sup> The present investigation was started with a view to study the structure and functions of the neurosecretory cells of the Indian cattle leech *Hirudinaria granulosa* (Sav.).

Sections of the cerebral ganglia, stained in Gomori's chrome alum-haematoxylin-phloxine, reveal the presence of distinctive types of neurosecretory cells in the brain of the leech. Of these, a large number belongs to a type of cells characterised by the abundance of vacuoles in the cytoplasm and scattered clumps of colloids stained blue (Fig. 1). These cells lie on the dorsal surface of the cerebral ganglia and measure about 53.39  $\mu$  in diameter, with large nuclei measuring about 11.65  $\mu$  in diameter and strongly phloxinophilic nucleoli. These cells

may be compared to the large "C" type of cells described by Clark<sup>2</sup> in the Polychæte *Nephtys*.

A second type of fewer, comparatively smaller cells, measuring about  $30.98\mu$  in diameter, with the cytoplasm uniformly filled with blue granules and distinctive axonic pathways, are also seen on the dorsolateral borders of the brain. These cells show no vacuoles. Two or three cells laterally, however, show a phloxino-philic cytoplasm.

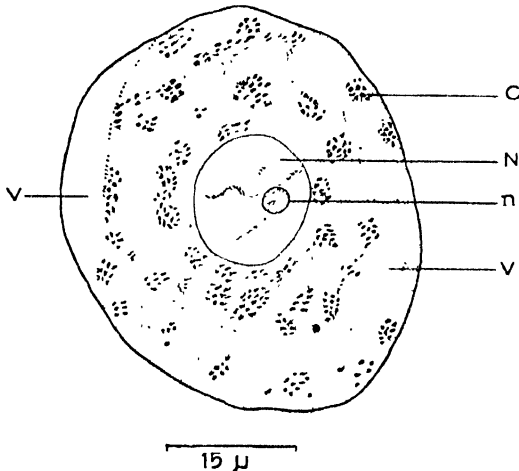

FIG. 1. Camera lucida drawing of a vacuolated type of neurosecretory cell from the brain of *Hirudinaria granulosa* (Sav.). Fixation: Bouin + Gomori's chrome alum-haematoxylin-phloxine. C = colloids; N = nucleus; n = nucleolus; V = vacuole.

An accumulation of blue colloids and granules is seen on the dorsal, outer periphery of the brain, where the latter lies contiguous with the ventral hæmocœlomic channel investing the nerve ring. This abundance of stainable material suggests a possible release of the neurosecretory colloids into the hæmocœlomic fluid. Such a condition is especially well marked in leeches which have been starving for a few weeks.

Dept. of Zoology, P. N. NAMBU DIRI.  
Govt. Victoria College, K. P. VIJAYAKRISHNAN.  
Palghat, April 8, 1958.

### OCCURRENCE OF *PARAPENAEOPSIS CORNUTUS* KISHINOUE IN THE SEAS OF INDIA

In July 1957, while making a routine collection of *Metapenæus monoceros* from Mahim, Bombay, a few specimens of *P. cornutus* were found mixed with those of *P. maxillipedo* in the catch of a drag net. *P. cornutus* is very much allied to *P. maxillipedo* but differs from it, in the absence of a basal spine on the third pereopod of the female and in the possession of a typically boot-shaped endopodite on the second pleopod of the male.

The specimens range in size from 40-60 mm. The rostrum is sigmoid and dorsally armed with 6-7 teeth. Branchiocardiac sulcus present in both the sexes. Telson unarmed. Cardiac plate with 28-29 spinules. Zygocardiac ossicle with 5 teeth in the upper row, leading to a cluster of smaller teeth. The thelycum consists of a sub-rectangular anterior plate, covered with setæ on the distal half of the ventral surface and a posterior plate, which is bifid anteriorly. The distal projections of the petasma are long and slender. In male, the endopodite of the second pleopod is typically boot-shaped and is provided with a number of small setæ on the distal margin. In fresh condition, the body is faintly bluish with transverse brown straps on the abdomen. Uropods are purple red.

The species seems to be uncommon. The present description essentially agrees with the description of Dall (1957) and the important differences between the present description and the description of Kubo (1949) are of the gastric armature only.

Previously recorded in Australia (Dall), Japan (Kishinouye, Osada, Tanizaki and Nakazawa), Formosa (Maki, Tuchiya and Kubo), Java (De Man). This is the first record of the species in the Indian waters.

Dept. of Zoology, D. D. MEHENDALE.  
Institute of Science, V. B. TEMBE.  
Bombay-1, May 7, 1958.

1. Dall, *Aust. J. Mar. Freshw. Res.*, 1957, **8**, 215-17.
2. Kubo, *J. Tokyo Coll. Fish.*, 1949, **36**, 374-78.

### ASSEMBLAGE OF TEN SPECIES OF COCCINELLID BEETLES ON BANYAN TREES AT KUNDRI FOREST IN BIHAR

SEVERAL instances of mass assemblage of various Coccinellid beetles, either in hibernation or in æstivation, from various countries have been reported. In India, Kapur (1943, 1954) has recorded mass assemblage of *Thea bisoctonotata* Muls. at Lahore, and *Epilachna bisquadri-*

1. Scharrer, B., *The Hormones*, 1955, **3**, 57-95.
2. Clark, R. B., *Compt. rend. Acad. Sci. Paris*, 1955, **241**, 1171-73.
3. Herlant Meewis, H., *Ann. Des. Sci. Nat. Zool.*, 1956, **18**, 185-98.
4. Scharrer, B., *Naturwiss.*, 1937, **25**, 131-38.

*punctata* (Gyllenhal) in Chotanagpur. Mani (1954) observed *Coccinella septempunctata* L. at glacier beds of Lakka pass in Western Himalayas. Rao and others (1954) cite an instance of aestivation in large numbers of *Chilocorus nigritus* F. on Banyan (*Ficus bengalensis*) trees in Madras State.

The writers also observed a similar instance of an assemblage on a large scale of ten species of predaceous Coccinellid beetles on Banyan (*Ficus bengalensis*) trees at Kundri forest in Palamu Forest Division, Chotanagpur. This forest is almost a pure patch of naturally-occurring *palas* (*Butea monosperma*) trees numbering over forty thousand and is exploited for lac cultivation by the Indian Lac Research Institute. In addition to *palas* trees, a few other species of trees including some *Ficus* sp. also occur. The area is one of the hottest places in Bihar and the maximum temperature in summer goes up to 115-20° F.

Observations made between April and July in the years 1956 and 1957, indicated that this phenomenon was exhibited by 10 species of predaceous Coccinellid beetles and the beetles were invariably found on the Banyan trees on the under-surface of leaves and on the fruits. The Banyan trees were free from any kind of insect infestation and there was no food attraction for such an assemblage.

The species recorded in the order of abundance are the following:—

1. *Chilocorus nigritus* (F.).
2. *Cœlophora cardoni* Weise.
3. *Thea cincta* (F.).
4. *Pharoscyrnus flexibilis* Muls.
5. *Scymnus nubilus* Muls.
6. *Scymnus coccivora* Ramakrishna.
7. *Catana parcesetosa* Sicard.
8. *Menochilus sexmaculata* Fabr.
9. *Synia melanaria* var. *rougeti* Muls.
10. *Stethorous gilvifrons* Muls.

The first-mentioned species was the most abundant of all and was observed in many hundred clusters, each cluster containing from 15-40 beetles. With the advent of the monsoons the beetles disappeared from the Banyan trees.

Observations made in January-February 1958, showed that five of the ten species mentioned above had congregated on the Banyan trees. In this season, however, the clusters and individuals per cluster were comparatively fewer in number, as indicated below in the collections made from lower branches of nine Banyan trees present in the area.

1. *Chilocorus nigritus* (F.) (271).
2. *Cœlophora cardoni* Weise (76).

3. *Menochilus sexmaculata* F. (14).
4. *Thea cincta* (F.) (2).
5. *Synia melanaria* Muls. (1).

The number per cluster ranged between 2-16. It was also noted that there was a definite tendency on the part of the beetles to get under protected situations such as, in between two leaves webbed together by spiders or within curled leaves.

As an explanation of this phenomenon, various theories have been advanced such as lack of food, urge to seek more equitable temperature and changes of physiological origin, etc. The fact that more than one species of beetles were found attracted to the Banyan trees which offered comparatively cooler environment in summer and less cold environment in winter seems to support the theory of urge to seek more equitable temperature.

Of the ten species recorded in this note, all except *Chilocorus nigritus* F. have been observed for the first time in India to be exhibiting this phenomenon.

The writers are indebted to Dr. A. P. Kapur, Zoological Survey of India, for kindly identifying specimens of *Cœlophora cardoni* Weise.

Indian Lac. Res. Inst., C. P. MALHOTRA.  
Namkum, Ranchi, S. KRISHNASWAMI.  
Bihar, March 22, 1958.

1. Kapur, A. P., *Indian J. Ent.*, 1944, 5, 165.
2. —, *Curr. Sci.*, 1954, 23, 230-31.
3. Mani, M. S., *Agra Univ. J. Res. (Sci.)*, 1954, 3, 13.
4. Rao, V. T., David, A. L. and Mohan Rao, K. R., *Indian J. Ent.*, 1954, 16, 207.

#### RESPIRATORY SYSTEM OF THE QUEEN OF *FORMICA FUSCA* L.

THE queens of Formicoidea dispose of their wings and generally these deilated individuals use their fat body and the product of histolysis of the large wing muscles as food. The present note deals with the changes in the respiratory system as a consequence of the degeneration of flight muscles in *Formica fusca* L. The following interesting observations were made while engaged in the study of the respiratory system of Hymenoptera. It may be mentioned here that it takes over 2-3 weeks for the partial degeneration of the muscles. Briefly, the system of tracheæ and air-sacs in the thorax of the alated queen is as follows. The cervical tracheæ on entering the prothorax are connected by a transverse tracheal commissure. There are lateral air-sacs in the mesothorax. These extend dorsally in the meso-

scutellum forming paired mesoscutellar sacs. The paired mesoscutellar sacs proceed to the anterior side giving rise to the dorsal muscular sacs. In the propodeum (epinotum) the lateral sacs again extend dorsally and form a single dorsal propodeal sac. Ventrally there are ventro-lateral sacs in the thorax and paired ventral propodeal sacs in the propodeum. Short tracheæ connect the lateral sacs and dorsal propodeal sacs to the second thoracic and propodeal spiracles respectively (Fig. 1).

(epinotum). In the cephalic region the air-sacs are all more enlarged and more tubular connectives occur between the various relevant sacs. In the abdomen there are a few variations. The above findings clearly suggest some post-metamorphic changes in the tracheal system connected with the degeneration of thoracic musculature. Janet (1902, 1907) has noted a similar phenomenon in *Lasius niger* Linn.

A full account of these observations will be published elsewhere.

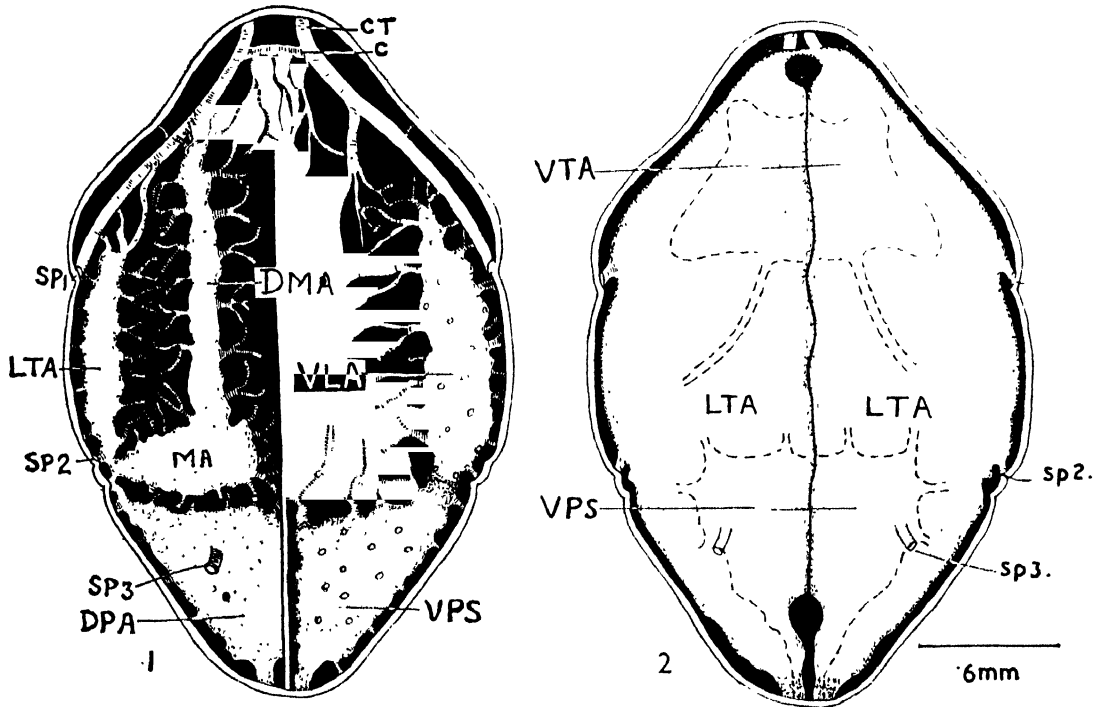

FIG. 1. Dorsal view of the air-sacs in the thorax of the winged queen of *Formica fusca* L. SP<sub>1</sub>-SP<sub>3</sub> = Spiracle and spiracular trachea; CT = Cervical trachea; C = Transverse Commissure; LTA = Lateral thoracic air-sac; DMA = Dorsal muscular air sac; MA = Mesoscutellar air-sac; DPA = Dorsal propodeal air-sac; VLA = Ventro-lateral air-sac.

FIG. 2. Dorsal view of the air-sacs in the thorax of the dealated queen of *Formica fusca* L. LTA = Lateral thoracic air sac; SP<sub>1</sub>-SP<sub>3</sub> = Spiracle and spiracular trachea; VTA = Ventral thoracic air-sac; VPS = Ventral propodeal air-sac.

But in the thorax of the dealated queens, there are only a few degenerated muscle fibres dorsally and ventrally and almost the entire space is occupied by two enormous sacs (Fig. 2). The two sacs are connected in the anterior part of the thorax. Spiracular tracheæ are very short. These two lateral thoracic sacs are connected with a median anterior ventral thoracic sac near the first phragma—as well as the ventral posterior thoracic sac in the propodeum

M.A.C.S. Laboratory,  
Law College Buildings,  
Poona-4, May 27, 1958.

G. T. TONAPI.

1. Janet, C., *Anatomie du gaster de la Myrmica rubra Paris*, 1902, pp 88.
2. —, "Anatomie du corset et histolyse des muscles vibrateurs, apres le vol nuptial, Chez La reine de la fourmi," *Limoges*, 1907, pp. 194.



VARIATION IN THE STAMEN  
NUMBER IN *ORYZA BRACHYANTHA*  
A. CHEVAL. ET ROEHR. AND THE  
FREQUENCY OF OCCURRENCE OF  
3-STYLED GYNAECEA IN *O. GRANDI-  
GLUMIS* PRODOEHL.

THE genus *Oryza* belongs to the tribe *Oryzæ* of the natural order Graminae. This genus according to Chatterjee (1948), is characterised by the possession of six stamens. Chatterjee loc. cit. has described 23 species of *Oryza*, but nowhere has he mentioned about the stamen number of any species being less than six. Hector (1936) describes the florets of *O. sativa* as possessing six stamens in two regular whorls, with central ovary smooth and surmounted by two long styles with plumose stigmas. At the Central Rice Research Institute, a number of species of *Oryza* are under study; examination of one of these species, viz., *Oryza brachyantha* A. Cheval. et. Roehr. (Fig. 1)



FIG. 1. *O. brachyantha* in flower.

showed the presence of a varying number of stamens, in different spikelets on the same panicle. The stamen number varied from 2-6 per spikelet, with 46.8% of the spikelets possessing 4 stamens each and 40.2% having 5 stamens each (Fig. 2). Two and three stamens per spikelet occurred occasionally, while six occurred rarely. Ten random panicles were examined; results are presented in Table I.

In plants, the presence of a large number of free stamens is considered a primitive character, while its reduction in number or uniting together is considered an advanced character. Thus the reduction in the number of stamens in *O. brachyantha* from the normal six to five

and less may be regarded as a step towards advancement in the process of evolution.

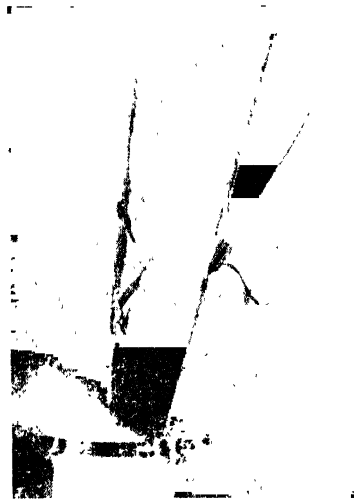

FIG. 2. Panicles of *O. brachyantha*.  
Left. Spikelet with four stamens.  
Right. Spikelet with five stamens—four visible, one covered up.

TABLE I  
Frequency of occurrence of different stamen  
numbers in the spikelets of  
*Oryza brachyantha*

Panicles No.	Stamens per spikelet					Total
	2	3	4	5	6	
1	1	1	1	..	..	3
2	..	1	2	..	..	3
3	..	2	1	4	..	7
4	1	..	5	3	1	10
5	1	1	1	1	..	4
6	..	1	4	6	..	11
7	..	..	5	5	..	10
8	..	..	4	5	..	9
9	..	..	6	3	..	9
10	..	..	7	4	..	11
Total ..	3	6	36	31	1	77
Percentage on Total	3.9	7.8	46.8	40.2	1.3	100.00

Occurrence of two and three styles in different spikelets of the panicle in *O. grandiglumis* Prodoehl., has been reported by Chandrasekharan et al. (1950), while that in *Oryza sativa* has been reported by Ray (1951) and Ghose and Butany (1952). Spikelets from several panicles of *O. grandiglumis* were examined and it was found that of the 907 spikelets examined, 596 (65.7%) had three-styled stigmas while 311 (34.3%) had two-styled stigmas.

Plants raised separately from three-styled and two-styled spikelets, did not breed true for the style number, but once again produced plants with two and three-styled spikelets in the same panicle.

Central Rice Res. Inst.,  
Cuttack, April 5, 1958.

W. T. BUTANY.

1. Chandrasekharan, S. N., Sundararaj, P. D. and Ramanathan, K., *Curr. Sci.*, 1950, **19** (19), 291.
2. Chatterjee, P., *Ind. J. Agric. Sci.*, 1948, **18** (3), 185.
3. Ghose, R. I. M. and Butany, W. T., *Ind. J. Genet. Pl. Breed.*, 1952, **12** (1), 25.
4. Hector, J. M., *Introduction to the Botany of Field Crops*, Central News Agency, Ltd., Johannesburg, 1936.
5. Ray, G. L., *Curr. Sci.*, 1951, **16**, 371.

**A NEW TERRESTRIAL SPECIES OF  
OEDOGONIUM (*Oe. RANDHAWÆ* SP.  
NOV.) FROM WEST BENGAL, INDIA**

THE genus *Oedogonium* was considered as aquatic till in 1939, Randhawa described a terrestrial species of *Oedogonium*, *Oe. terrestris* from Fyzabad District, Uttar Pradesh, India.<sup>1</sup> This was the first and only record of a terrestrial species of *Oedogonium*. In September 1957, the same author collected another terrestrial species of *Oedogonium* from the garden of Agri-Horticultural Society, Calcutta, and has kindly placed the material at my disposal.

The alga grows on wet soil in dark green circular patches. The filaments are long and unbranched. The vegetative cells are cylindrical and in the sub-aerial parts 14-16  $\mu$  broad and 28-40  $\mu$  long. The subterranean cells which serve the function of the rhizoids are hyaline, and elongated. The apical cell is obtuse.

This species is monœcious and the oogonium is usually single, intercalary and rarely terminal, subglobose to pyriform in shape (Figs. 3-6). Oogonia are 24-36  $\mu$  broad, 32-36  $\mu$  long, operculate and the opening is by means of a superior operculum. The oospores are globose, 28  $\mu$  in diameter, pale brown in colour, partially fill the oogonium, and the spore-wall is reticulate (Figs. 3 and 6). The antheridia are sub-epigynous as well as sub-hypogynous, 12-14  $\mu$  broad and 3.8-7.6  $\mu$  long, 1-4 in number, and each antheridium produces two sperms by a horizontal division (Figs. 3-5).

The only related species is *Oe. terrestris* Randh. which the present alga resembles in its monœcious nature and terrestrial habitat, but from which it differs in its reticulate spore-

wall and the antheridium producing two sperms. This species differs from the other known species of *Oedogonium* in its terrestrial habitat and reticulate spore-wall.

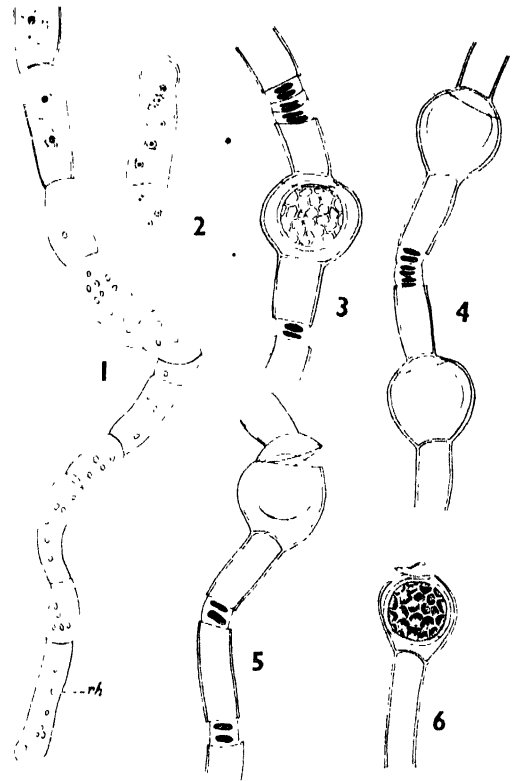

FIGS. 1-6. *Oedogonium randhawae* sp. nov. Fig. 1. Part of a filament showing sub-aerial and subterranean portions, Fig. 2. A terminal cell; Figs. 3-5. A filament showing oogonia and antheridia; Fig. 6. A terminal oogonium. (Note the opening by the lid in Figs. 5 and 6, and the reticulate spore-wall in Figs. 3 and 6. (Figs. 1-6,  $\times 860$ .) (*rh* = rhizoid.)

*Oedogonium randhawae* sp. nov.—Monoicum : terrestris ; oogoniis singulis, intercalaris (rarius terminalis), oogoniis subglobois vel pyriformibus, operculo apertis, circumscissione superiore ; oosporis globosis, oogonia non-complentibus, mesosporia reticulatus, pallide fusco ; antheridiis subepigynis vel subhypogynis, gametis masculis binis, divisione horizontali ortis, 1-3 continuis ; cellula terminali apice obtuse ; cellula basali forma, ut vulgo, elongata ; cellulis vegetativis 14-16  $\times$  28-40  $\mu$  ; oogoniis 24-36  $\times$  32-36  $\mu$  ; oosporis 28  $\mu$  latis ; antheridiis 12-14  $\times$  3.8-7.6  $\mu$ .

*Habitat*.—Growing on wet soil in the garden of Agri-Horticultural Society, Alipore Road, Calcutta, Bengal, India, September 20, 1957.

I am highly grateful to Dr. M. S. Randhawa

for his kindness in placing the material at my disposal. My sincere thanks are also due to Dr. B. P. Pal and Dr. S. M. Sikka for kindly providing the facilities for work.

Algal Laboratory, G. S. VENKATARAMAN,  
Division of Botany,  
I.A.R.I., New Delhi-12,  
April 30, 1958.

1. Randhawa, M. S., *Hedwigia*, 1939, **78**, 281-83.

### EFFECT OF PRE-SOAKING SEED TREATMENT WITH 2 METHYLBENZIMIDAZOLE ON RICE SEEDLINGS

BENZIMIDAZOLE has been recently reported to have growth inhibitory properties. Woolley<sup>1</sup> noted that benzimidazole inhibited the growth of several yeasts and bacteria. Klotz and Melody<sup>2</sup> reported inhibitory effect of the same on certain bacteria. Galston *et al.*<sup>3</sup> observed that benzimidazole caused an inhibition of cell elongation in pea plants. Rebstock *et al.*<sup>4</sup> demonstrated that several acid analogues of 2-mercaptobenzimidazole inhibited the growth of Cranberry bean plants and root formation in cucumber seeds. The present investigation has been designed to study the effect of 2-methylbenzimidazole<sup>5</sup> on rice seedlings.

Selected seeds of an early-maturing variety of rice, N.136, were soaked separately for 48 hr. with 10 c.c. of each of the four concentrations, 1, 10, 100, and 1,000 parts per million (p.p.m.) of 2-methylbenzimidazole. Another series soaked simply in distilled water was maintained as controls. The seeds were next thoroughly washed in running water and were sown in seed pots containing sawdust at the rate of 100 seeds per pot. Each treatment had three replications.

The results are presented in Table I and they bring out the following points.

1. The chemical induces a significant stimulating effect on the length of root and shoot as well as on their fresh weight at the two lower concentrations of 1 and 10 p.p.m. over those of the controls. The relative effectiveness of 1 and 10 p.p.m. appear almost to be the same.

2. On the other hand, just an opposite effect of inhibition which is statistically significant is observed in all these characteristics at the two higher concentrations of 100 and 1,000 p.p.m., more conspicuous effects being marked in the highest concentration. As between the effects

TABLE I

Effect of 2-methylbenzimidazole on length of root and shoot and number of roots

(Soaking date: 8-1-1958)

(Each figure is an average of 9 seedlings)

Days from soaking	Concentration in p.p.m.					S.E. Mean and C.D. at 5% for treatment concentration
	0	1	10	100	1000	
Total length of all roots per seedling in mm.						
7	12.1	13.0	10.8	8.2	7.0	..
12	30.0	38.2	34.7	22.2	18.0	1.62
16	59.3	50.2	55.4	25.0	18.9	3.33
20	89.7	82.6	81.6	62.1	23.1	..
25	93.6	95.5	100.0	78.1	28.5	..
Length of shoot per seedling in mm.						
7	15.1	18.7	17.3	12.6	6.0	..
12	42.7	50.8	47.2	41.0	38.3	1.03
16	69.6	63.7	61.8	46.6	42.9	2.92
20	84.7	98.0	95.8	79.1	72.9	..
25	112.3	116.5	113.3	89.8	87.2	..
Number of roots per seedling						
7	..	..	..	..	..	..
12	3.1	3.2	3.2	2.7	2.3	0.12
16	4.1	3.7	3.8	3.1	2.6	0.45
20	4.1	3.9	4.2	3.2	2.7	..
25	4.6	4.3	4.7	4.1	3.0	..

on root growth and shoot growth it is seen that there is not much difference at the concentration of 100 p.p.m. but at the highest concentration of 1,000 p.p.m. the inhibition in root growth is more pronounced than shoot growth.

Thus as has been observed in case of some auxins,<sup>7</sup> the growth responses to 2-methylbenzimidazole show a two-phase concentration curve with promotive effects at low concentrations and inhibitory effects at high concentrations.

We are thankful to Dr. M. K. Rout, Sri. B. K. Patnaik and to Sri. P. K. Misra of the Chemistry Department of this College, for kindly synthesizing and supplying us the chemical.

Department of Botany,  
Ravenshaw College,  
Cuttack-3, April 16, 1958.

G. MISRA.  
D. MISHRA.

1. Woolley, D. W., *J. Biol. Chem.*, 1944, **152**, 225.
2. Klotz, I. M. and Melody, M., *J. Bact.*, 1948, **56**, 253.
3. Galston, A. W., Baker, R. S. and King, J. W., *Physiol. Plantarum*, 1953, **6**, 863.
4. Rebstock, T. L., Ball, C. D., Hamner, C. I. and Sell, H. M., *Plant Physiol.*, 1955, **30**, 382.
5. —, —, — and —, *Ibid.*, 1957, **32**, 19.
6. Misra, P. K., *M.Sc. Thesis*, Utkal University, 1957.
7. Zeeuw, D. de and Leopold, A. C., *Amer. J. Bot.* 1956, **43**, 478.

CYTOLOGY OF TWO SPECIES OF  
SALVINIACEÆ

The present study reveals that the two genera *Salvinia* and *Azolla* possess  $n=9$  and 22 res-

In recent years the cytology of most of the homosporous fern genera has been studied. Although we know a fairly good deal regarding the morphology of the heterosporous members of the Filicales, practically nothing is known of their cytology, an aspect which may prove helpful in deducing the phyletic affinities of these ferns. In view of this, it was considered worthwhile to work out the available members of this group of plants.

Mehra and Loyal<sup>6</sup> reported the chromosome number of *Marsilea minuta* from Punjab plains. The present report intends to record the cytological observations on *Azolla pinnata* R. Brown and *Salvinia natans* All. following the usual acetocarmine squash technique. The course of meiosis is normal in both, resulting in the formation of seemingly viable mega- and microspores.

*Azolla pinnata* is widely distributed and according to Baker<sup>2</sup> the variety *africana* is known from tropical Africa, Asia, Japan and Madagascar. In the Punjab the species grows profusely in ponds and ditches as long as water is available. Generally the spore formation occurs from October to April. In a number of preparations 22 bivalents are counted at diakinesis within the microspore-mother-cells (Fig. 1 and Explanatory Fig. 2). Earlier Litarriere<sup>5</sup> reported  $2n=48$  in *Azolla carolineana* but his observations were based upon sectioned material which experience has shown may not be trustworthy. The size of the chromosomes in this species is very small, perhaps the smallest amongst the ferns.

*S. natans* was collected from Dal Lake and other streams in Srinagar (Kashmir) in September 1957, where it grows prolifically as a weed. Avanzie-D'Amato<sup>1</sup> reported  $2n=18$  in the material of *S. natans* collected from Pisa (Italy). Cytologically the Kashmir material resembles the Italian one and shows 9 bivalents in several spore mother-cells (Fig. 3). This number has been confirmed at  $A_1$  (Fig. 4). The somatic number determined from tapetal cells is clearly 18 (Fig. 5). The chromosomes are somewhat larger than those of *Azolla pinnata*.

Bower<sup>3</sup> and Copeland<sup>4</sup> suggested on morphological evidence that the family Salviniaceæ is related to Hymenophyllaceæ. Mehra and Singh<sup>7</sup> pointed out that the multiples of the number 9 are deep-seated in Hymenophyllaceæ, besides other numbers like 13 and 33. The latter number may be based on the number 11.

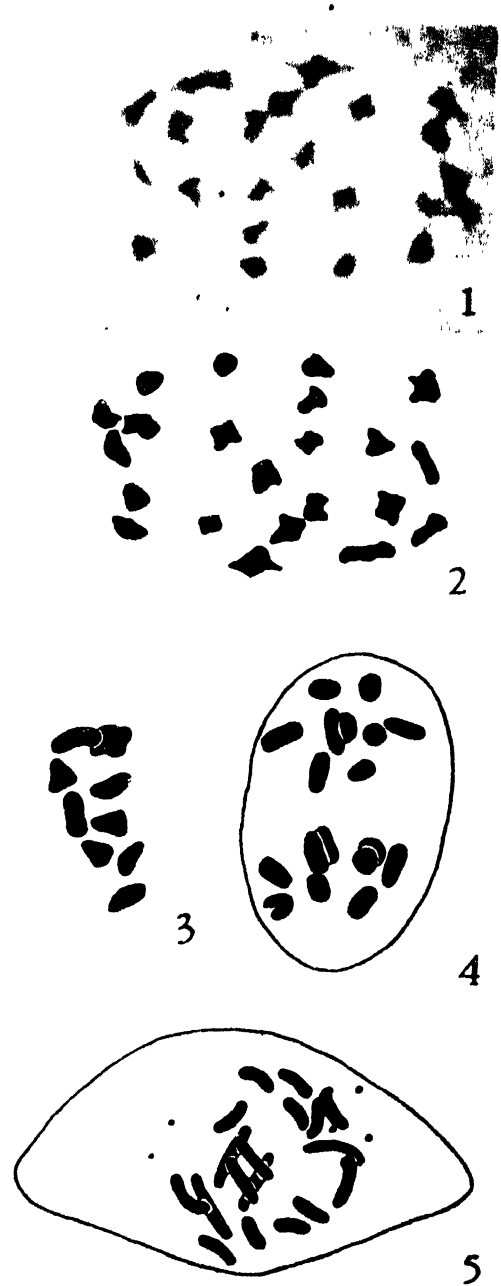

FIG. 1 and Explanatory Fig. 2. *Azolla pinnata*, Diakinesis  $n=22$ ,  $\times 3,600$ . Figs. 3-5. *Salvinia natans*. Fig. 3. Diakinesis  $n=9$ . Fig. 4. Anaphase 1, 9-9. Fig. 5. Tapetal cells with  $2n=18$ . All figs.,  $\times 2,640$ .

pectively. It is tempting to relegate the latter number also to the base number 11. There, thus seems to be good cytological evidence in

favour of the relationship of this family with Hymenophyllaceæ. But there is a remarkable difference in size of the chromosomes in the two families. In Hymenophyllaceæ they are the largest amongst ferns<sup>6</sup> while in *Azolla* they are perhaps the smallest. It is also important to record that  $n = 9$  is the lowest number yet recorded for a fern genus.

The writer wishes to express his gratitude to Prof. P. N. Mehra for valuable guidance and encouragement. Thanks are also due to Mr. R. S. Pathania for photomicrograph, and Mr. C. L. Khoshoo for the collection of *S. natans*.

Department of Botany, D. S. LOYAL,  
Panjab University,  
Amritsar, April 16, 1958.

1. Avanzio D'Amato, *Maria Graia*, 1957; *Caryologia*, 1957, **9**, 373-75.
2. Baker, J. G., *Handbook of the Fern Allies*, London, 1887.
3. Bower, F. O., *The Ferns*, Camb. Univ. Press, 1928, **3**.
4. Copeland, E. B., *Genera Filicum*, Chronica Botanica Co., Waltham, Mass., 1947.
5. Litardiere, R. de, *La cellule*, 1921, **31**, 255-74.
6. Manton, I., *Problems of Cytology and Evolution in the Pteridophyta*, C.U.P., London, 1950.
7. Mehra, P. N. and Singh Gurdip, *Jour. of Genet.*, 1956, **55**, 379-93.
8. — and Loyal, D. S., *Nature*, 1958, **181**, 577.

#### 'CHIMERA' IN TUR (*CAJANUS CAJAN* MILLSP.)

DURING the course of genetic studies in a cross between two mutants, a creeping and a round leaf type, at the Agricultural Research Station, Niphad, District Nasik, a plant numbering 239 in the  $F_2$  generation was observed during the season 1954-55, having very small leaves, few flowers and late in blooming. It has an abnormal structure 'distinctly different, as compared to either of the parental lines. Selfed seeds when sown during 1955-56 gave only two good plants, similar to the original in structure, but differing in flower and pod colour. Both plants were selfed and seeds obtained were sown in 1956-57. Two plants in the progeny gave rise to a branch having half small leaves and other half (apex side) with normal leaves, i.e., the normal leaf part differed in its phenotype from the rest of the same plant (Fig. 1).

On the close examination of the flowers from both parts, they were found normal. Selfed seeds from both the parts were collected and sown in 1957-58 season, the progenies of neither

were true breeding, i.e., they exhibited non-Mendelian inheritance. The somatic cells might have mutated and given rise to new tissues and



FIG. 1

hence it may be considered a case of *Chimera*. A few similar plants have been observed in the subsequent progenies of the same cross in 1957-58 season also.

This appears to be the first instance of a *Chimera* occurring in Tur (*Cajanus cajan* Millsp.).

We are highly obliged to Prof. V. M. Chavan and Dr. S. Soloman for going through the note and giving valuable suggestions.

Agric. Res. Station, J. A. PATIL,  
Niphad, Nasik, N. V. SANDBHOR,  
April 17, 1958.

#### CHROMOSOME NUMBERS OF SOME SOUTH INDIAN SPECIES OF *VITACEAE*

THE family *Vitaceae* comprises about 12 genera and over 500 species, mostly tropical and subtropical. Gamble (1918) has recorded seven genera and 41 species in "Flora of the Presidency of Madras". Chromosome numbers for 16 wild species belonging to 5 genera and also for the 2 cultivated species of *Vitis*, viz., *Vitis vinifera* L. and *V. labrusca* L., are presented in Table I.

TABLE I

Name of Species and Variety	Counts by the author		Previous counts		Author
	2n	n	2n	n	
1 <i>Vitis vinifera</i> L.					
(i) var. Green grape (Krishnagini type)	38	19	38	..	Krishnaswamy <i>et al.</i> (1954)
(ii) 'Kishmish' ('Sultana'—seedless) ..	38	19	38	..	do.
(iii) 'Red Prince' ..	38	19	..	..	
(iv) 'Black Prince' ..	38	..	..	..	
(v) 'Habshi' ..	38	..	..	..	
(vi) 'Anab-e-Shahi' ..	38	..	..	..	
2 <i>V. labrusca</i> L. var. 'Bangalore Blue' ..	38	19	..	..	
3 <i>Ampelocissus latifolia</i> Planch. ..	40	20	..	20	Syamal and Patel (1953)
4 <i>A. tomentosa</i> Planch. ..	40	20	..	..	
5 <i>Tetrastigma sulcatum</i> Gamble ..	22	11	22	..	Krishnaswamy <i>et al.</i> (1954)
6 <i>T. lanceolatum</i> Planch ..	44	..	44	..	
7 <i>Parthenocissus nitgherruensis</i> Planch. ..	40	..	..	..	do
8 <i>Cissus quadrangularis</i> L. ..	24	12	24	..	Sundara Raghavan (1957)
9 <i>C. pallida</i> Planch. ..	24	12	26	..	Krishnaswamy <i>et al.</i> (1954)
10 <i>C. glauca</i> Roxb. ..	24	12	24	..	do.
11 <i>C. discolor</i> Blume ..	24	12	24	..	do.
12 <i>C. heynana</i> Planch. ..	24	..	28	..	do.
13 <i>C. rotiginea</i> L. ..	26	13	..	..	
14 <i>C. adnata</i> Roxb. ..	48	..	..	..	
15 <i>C. setosa</i> Roxb. ..	22	11	..	..	
16 <i>Cayratia tenuifolia</i> Gagnep ..	30	15	..	..	
17 <i>C. pedata</i> Juss. ..	72	..	..	..	
18 <i>C. carnosia</i> Gagnep. ..	98	..	..	..	

The chromosome numbers reported herein form part of a thesis presented for the award of the M.Sc. degree of the Madras University, in January 1957.

Cytogenetics Laboratory, B. V. SHETTY.  
Agricultural Res. Institute,  
Coimbatore, May 13, 1958.

1. Gamble, J. S., *Flora of the Presidency of Madras*, 1918, 1, 226.
2. Krishnaswamy *et al.*, *Curr. Sci.*, 1954, 23, 61.
3. Sundara Raghavan, R., *Proc. Ind. Acad. Sci.*, 1957, 45 B, 294.
4. Syamal, N. B. and Patel, G. I., *Proc. Amer. Soc. Hort. Sci.*, 1953, 62, 223.

### OCCURRENCE OF CARAPA SPP. IN THE SO-CALLED PEAT BED NEAR CALCUTTA

FOR well over a century, tree trunks, roots and other isolated plant remains have been recovered from different strata of the peat beds of Calcutta and its neighbouring areas. Excavations as reported by Oldham,<sup>1</sup> Blanford<sup>2</sup> and Ghosh<sup>3</sup> have revealed the existence of a peaty layer at depths of 5.5-10.7 m. not only in and around Calcutta but also further north and eastwards upto Jessore and Khulna respec-

tively. The chief points of interest about this peaty layer are the presence of tree stumps and roots *in situ* indicating existence of a forest and the occurrence of *Heritiera* spp. as the predominant tree of this submerged forest. Lately, some specimens excavated by the Department of Archaeology, Government of India, from Barisa near Calcutta, have been pronounced by Ghosh as definitely *Heritiera* spp. based on modern methods of wood anatomy.<sup>4</sup>

Recently, however, while examining several lumps of carbonaceous material and buried woods sent by the Director, Geological Survey of India, we have come across one specimen which is entirely different from others so far reported from the peat bed, and is described below.

The material has been collected from a horizon of carbonaceous clay, from Narayanpur Colony (lat. 22° 8', long. 88° 27') near Dum Dum, West Bengal. It is almost black in colour due to ageing. However, when split, the inner portion of the wood shows deep wine-red colour. The wood is free from any attack by fungus or insect, and is rather compact in nature with abundant deposits. It is moderately heavy (specific gravity 0.71), rather interlocked-grained, and somewhat fine-textured. The anatomical structure is distinct only under the microscope. The wood is typically diffuse-

porous. *Growth rings* are noticeable under the microscope, and are delimited by narrow initial parenchyma bands (Fig. 1), 8-11 per cm.

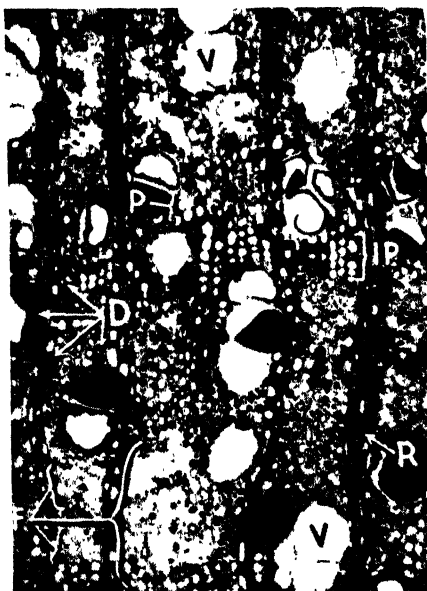

FIG. 1. Transverse section showing initial parenchyma (IP), vessels (V), rays (R), and paratracheal parenchyma (P). Note copious dark deposits (D) and deteriorated fibres (F). ( $\times 60$ ).

Vessels are small to medium-sized, 56-140  $\mu$  in diameter, usually solitary, occasionally in radial rows of 2-4, moderately numerous, 11-18 per mm<sup>2</sup>, round to oval in outline and frequently plugged with dark gummy deposits (Fig. 1). Parenchyma are of two types: (a) apotracheal in concentric rows, often 3-5 cells wide (initial), but sometimes may be more than 8 cells demarcating growth rings; occasionally also diffuse but rather inconspicuous within the fibrous tissue; (b) paratracheal parenchyma is noticeable as a narrow sheath round the vessels often containing abundant brownish gummy deposits (Fig. 1). Fibres are often degraded (Fig. 1), non-libriform to semi-libriform, sometimes septate and filled with dark contents. Rays are heterogeneous (Fig. 2) and of two types—broad and high, 1-5 cells (mostly 3-4) and 45-67  $\mu$  in width and upto 35 cells or 810  $\mu$  in height; low rays 1-2 or 3 seriate, 13-15 cells (majority 10-15) and upto 450  $\mu$  in height; deposits in ray cells copious (Fig. 1). Ripple marks not distinct, traceable to cambiform parenchyma, short rays and sometimes vessels.

The structure described above is in close agreement with that of existing genus *Carapa* and the specimen is accordingly identified as *Carapa* spp. At present the genus *Carapa* is

represented by about 12 species of evergreen trees and flourishing best in the tidal forests



FIG. 2. Tangential section cleared in Stockwell's solution to show vessel (V), fibre (F), septa (S) and ray (R). ( $\times 60$ ).

and mangrove swamps.<sup>5</sup> Throughout the Sunderbans, however, the predominant tree is sundri (*Heritiera* spp.), though it is associated usually with *Carapa*, *Avicennia*, *Sonneratia*, and others.<sup>6</sup> *Carapas* being one of the closest associates of sundri, their occurrence in the peat bed may not, therefore, be without any significance.

Full details along with the observation on the effect of age on various cell characteristics will be published elsewhere.

Our grateful acknowledgements are due to Dr. M. S. Krishnan, former Director, Geological Survey of India, Calcutta, for supplying this interesting material for study and also helpful discussions. Our thanks are also due to Shri Krishna Lal of Wood Anatomy Branch, for constant help in the laboratory.

Forest Res. Institute,

Dehra Dun,

November 20, 1957.

S. S. GHOSH.

B. S. NEGI.

1. Oldham, R. D., *A Manual of Geology of India*, 2nd edition, 1893.
2. Blanford, H. F., *Jour. Asiatic Soc. Beng.*, 1865, **33**, 154-58.
3. Ghosh, A. K., *Science and Culture*, 1941, **6**, 669-70.
4. Ghosh, S. S., *Jour. Timber Dryer and Preservers' Assoc.*, 1957, **3**, 12-15.
5. Pearson, R. S. and Brown, H. P., *Commercial Timbers of India*, 1932, **1**.
6. Prain, D., *Rec. Bot. Surv. India*, 1903, **2**, 231-370.

## REVIEWS

### Transactions of the Society of Rheology, Vol. I.

Edited by Bryce Maxwell and R. D. Andrews.  
(Interscience Publishers, Inc., New York),  
1957. Pp. 222. Price \$ 6.00.

Rheology is a border science in which many disciplines meet to advance polymer technology. In recent years a good deal of both theoretical and experimental work has been done in the relaxation of stress with time in amorphous and crystalline polymers and the visco-elastic behaviour of natural and synthetic rubber. It is, therefore, gratifying to see 15 original papers in the first volume of the *Transactions of the Society of Rheology*.

The first paper by J. J. Birkman is a study of the tackiness of Newtonian liquids. His experiments with 2 plates and parallel solid plates show that tackiness is governed by Stefan's equation, is determined by the rheology of the adhesive and is not affected by molecular adhesion. J. V. Robinson finds that the upper limit of volume concentration for a suspension is the reciprocal of the relative sediment volume. Papers by H. Morkovitz, R. B. Williamson and W. P. Philipps discuss the normal stress effect in polyisobutylene solutions contained in a cone and plate instrument. These results confirm Rivlin's theory of visco-elasticity and show relationship between the normal stress effect and the dynamic rigidity. Hooke's Law in shear is found to hold good upto about a shear of 20. Combined with the results of the co-axial cylinder, these may be used to classify rheological theories. S. Prager obtains stress-strain relations for a dilute suspension of dumbbells, for both uniform and non-uniform velocity gradients and discusses the normal stress effect for a parabolic flow between two plates.

M. Mooney uses the published experimental data to show that the molecular thermal vibrations may be treated, after Debye, as the sum of elastic ultra-high frequency vibrations. H. M. Burte finds that strain aging embrittlement in titanium alloys may be treated by a plastic deformation giving rise to microsegregation of dissolved hydrogen. B. D. Coleman gives the mechanical model for discussing the time dependence of the mechanical strength measurements of polymer fibres. William Prager treats a mixed boundary value problem of ideal locking materials with prescribed surface displacements and surface tractions. H. L. Toor

solves the energy equation for a compressible non-Newtonian liquid entering a tube at temperatures equal to the wall temperature, and shows how the distance required to closely approach the steady profile may be obtained.

E. T. Sever and J. M. Austin describe the thermal incline to measure viscosity of plastisols through a wide range of temperatures. J. P. Tordella gives the photographic study of the melt-fracture of polyethylene and finds that there is no shear fracture. Herbert Leaderman, Chairman of the Committee of Nomenclature for Linear Visco-elastic Behaviour, gives the findings of the Committee in defining the minimum number of quantities to promote uniform methods of reporting data. All workers in the field will do well to adopt the nomenclature given.

The volume is a refreshing reminder of the importance of the study of rheology to industry. In India it has been mostly studied as High Polymer Chemistry. It is time, scientists with other disciplines start paying attention to it. Chemists, physicists, applied mathematicians and mechanical engineers all will find something to interest them in these *Transactions*.

B. R. SETH.

### Pressure Measurement in Vacuum Systems.

By J. H. Leck. (Published by the Institute of Physics, London). 1957. Pp. 144. Price 30 sh.

The production and measurement of high vacua are now finding enormous applications in industry. Several recent publications on this topic have now made their appearance and to this list, the book under review is a welcome addition.

The contents of the book has been divided into six chapters. In the first five, the various methods of measurement of vacua have been given in the sequence-mechanical methods, thermal conductivity methods, ionisation methods, radiometer methods and lastly surface reaction methods. The sixth chapter deals with the topic of gauge calibration.

The mechanical methods include the various types of McLeod gauges, their construction and methods of use. Mention has also been made of their limitations and methods of overcoming them so as to obtain satisfactory results. This chapter also includes the topic of diaphragm



manometers, their special uses and constructional details together with electronic methods of measurements of diaphragm movements.

The chapter on thermal conductivity gauges includes, besides the usual details, the particulars to secure compensation for temperature and voltage fluctuations and also data regarding the material, dimensions, and the physical features of the gauge elements. Electronic methods are described for the various measurements. An appendix to this chapter covers valuable information on the effect of heat conduction along the wire and of ambient temperature on the gauge reading.

The special features on the topic of ionisation gauges include a treatment on the relative sensitivity for different gases, the calculation of gauge sensitivity, the constructional details, electronic control circuits, the cold cathode gauge and the alphasatron.

The theory of the radiometer gauge, its experimental verification and the practical developments of the Knudsen gauge by later workers are described on radiometer methods.

The chapter on surface reaction techniques and their application in the measurement of vacua is a good contribution to the subject especially when measurements of pressure below  $10^{-10}$  mm. have to be made. This topic is dealt with under three main sections, namely, (1) by observations on changes in the surface-work-function, (2) by measuring the quantity of gas removed by flashing a filament at fixed intervals, and (3) by point emission microscope studies.

The concluding chapter is on gauge calibration and is in two sections, one for the range  $10^{-10}$  to  $10^{-3}$  mm. and the other  $10^{-3}$  to  $10^{-6}$  mm. The methods adopted in the latter case are rather indirect.

The author contends that this work is solely intended to cover the topic of measurement of low pressure. One interested in these techniques would naturally feel that in a book of this type at least a few introductory pages dealing with the latest methods of production of high vacua would have been a very desirable feature.

The book is written to a high standard and contains, in addition to a theoretical background, the practical aspects of gauge design. A post-graduate engaged in the working of high vacuum plants will find ample and useful information in this field. The get-up is nice, quite a number of descriptive sketches are given and at the end, the book contains useful and recent references for the matter contained in each chapter.

S. HARTHARAN.

**Flame Photometry—A Manual of Methods and Applications.** By F. Barriol-Marti, J. Ramirez-Munoz (Elsevier Publishing Co., Cleaver-Hume Press, Ltd., 31, Wright's Lane, London W. 8), 1958. Pp. xii + 531. Price 65 sh.

Although flame test as a qualitative analytical tool has been known from the days of Bunsen and Kirchoff who first introduced it, its ascendancy to the status of a quantitative method is a recent development. The work of Lundegårdh has contributed greatly to the evolution of flame technique. Today, it is a very important tool enabling accurate and quick determinations of a large number of chemical elements although in the initial stages, the method was directed to estimations of alkali metals only.

Flame methods do not claim a superiority over other methods, such as spectral analysis with the arc or the sparc, but the method has certain inherent simplicity and advantages. The number of lines excited are fewer, results are highly reproducible and amongst all spectrum sources, the flame has got the greatest stability. Further, in certain estimations of a routine nature, very simple apparatus is only required and is thus a very inexpensive method compared to others. The preparation of the sample and the method of introduction of solution as a spray into the flame are the two vital aspects to the success of the method in accurate estimations.

The book under review deals with the flame method of analysis by direct photometry. The contents are presented under six parts, (1) Origin and Principles of Flame Photometry, (2) Analysis by Flame Photometry, (3) Instrumental Systems, (4) Extent and Limitations of Flame Photometry, (5) Experimental Method, and (6) Analytical Applications.

The book covers under the above five heading all aspects of Flame Photometry to the minutest detail, and, in the opinion of the reviewer, is a very authoritative and thorough treatment on the subject.

Since the range of application of Flame Photometry as an analytical tool extends over a wide field, viz., biological, industrial, pharmaceutical, clinical, soil and agricultural chemistry, this book would be found as an invaluable guide to all those who are already using or contemplate using this method.

A comprehensive bibliography is appended at the end, which includes as many as 909 references. The get-up of the book is excellent and, considering the usefulness of the same, the price of 65 sh. is quite moderate.

A. J.

**Introduction to Fourier Analysis and Generalised Functions.** By M. J. Lighthill. (Cambridge University Press), 1958. Pp. viii + 79. Price 17 sh. 6 d.

The subject of generalised functions, like that of Heaviside's operational calculus, is one in which the applications have preceded the development of a rigorous mathematical theory. The best known example of a generalised function is the  $\delta$ -function of Dirac,  $\delta(x)$ , which is defined as zero for all values of the argument  $x$  except  $x = 0$  where it becomes infinite in such a way that  $\int_{-\infty}^{\infty} \delta(x) dx = 1$ . Mathematically this definition is devoid of meaning in any sense an integral is understood. There was never any doubt, however, about the utility of the  $\delta$ -function (when used with caution) as it serves as the mathematical model for certain idealised physical concepts like a point-source, an impulse, etc. One could not, nevertheless, conceal the feeling of uneasiness in the use of this function as there was no way until recently of justifying the operations performed on this function. As rightly emphasised by Prof. Friedmann, it is, therefore, the mathematician's task to find a method by which the use of the  $\delta$ -function (and other generalised functions) could be justified.

There have appeared during the past decade or so several successful attempts to provide a basis for the justification. The most celebrated of these due to Laurent Schwartz regards the generalised functions (and their derivatives) as linear continuous functionals (called distributions) over the space of test functions having suitably chosen properties. The method adopted in this book is based on the representation of generalised functions (and their derivatives) by means of approximating sequences of regular functions and follows the exposition given by Temple elsewhere. The book gives a concise exposition of the theory of generalised functions, their properties, and their Fourier transforms. The representation of generalised functions by Fourier series is discussed in considerable detail with several special functions chosen for examples. This short Cambridge monograph (one of the series on Mechanics and Applied Mathematics) is primarily addressed to the mathematical reader but remains accessible to the theoretical physicist and engineer. The reviewer, however, feels that the size (and even the price) of the book leaves enough room for the inclusion of a chapter on the use of the generalised functions in the solution of physical problems.

B. S. RAMAKRISHNA.

**Tracer Applications for the Study of Organic Reactions.** By John G. Burr, Jr. (Interscience Publishers, New York), 1957. Pp. x + 291 (11 Tables). Price \$ 7.50.

Isotopic tracers, both stable and radioactive, have in recent years become a powerful research tool in biological problems, but their use in organic chemistry has been comparatively limited. However, with the growing realisation of their potentialities in the determination of reaction mechanisms, quantitative analysis and elucidation of structures where employment of other techniques fails to provide unambiguous answers, the tracers are beginning to find an important place in the repertoire of the organic chemist along with IR absorption and electron diffraction analysis, NMR and gas chromatography.

One of the reasons for the less widespread application of this technique is perhaps to be found in an exaggerated sense of hazard and difficulties encountered in the use of isotopes, another being the lack of good literature reviews and text-books on the subject exclusively for the use of organic chemists. John G. Burr (Jr.), author of the book under review, in meeting this need, has done an able and worthy job and has produced what has turned out to be more than a "reasonably comprehensive survey of tracer applications in organic chemistry". The book is however not for the uninitiated in the use of tracers, but is meant mainly for the organic chemist whose problem, as the author would have it, is an organic reaction rather than use of an isotope. However, this defect, if at all, has been largely mitigated by the well-chosen list of reading material, by way of text-books and review articles, contained in Appendix A which provides a good coverage of the nature, properties, handling and analysis of stable and radioactive isotopes. In addition, the opening chapter of the book deals exclusively with some general considerations regarding the function of tracers, the specific types of situations where isotopic methods are superior or indispensable and carries an excellent concluding section on the nature of the results obtained by isotopic methods and the factors affecting their validity. The latter clearly brings home to the young enthusiast that the tracer methods should not be used for trivial investigations, but confined only to those situations where an answer cannot be had conveniently or unambiguously by the application of orthodox techniques.

In the succeeding dozen chapters, "the isotope applications have been arranged according

to the reaction classifications most familiar to the organic chemist". In order to provide adequate coverage of background material for an intelligent appreciation of the discussion of isotopic applications to the various reactions treated in these chapters, the author has thoughtfully added at the end of the book (Appendix B) a list of the better known texts on organic reaction mechanisms which would be found extremely useful. Apart from the references given at the end of each chapter, there is an Appendix C with more references, classified according to each chapter heading, and these together bring the literature coverage upto early 1955.

The get-up of the book is in the tradition of Interscience Publishers and but for a rare misprint or two, the text is carefully edited. It is extremely informative and therefore deserves a place in an organic chemist's bookshelf.

R. K. M.

---

**The Strategy of Chemotherapy.** (The Eighth Symposium of the Society for General Microbiology, held at the Royal Institute, London.) (Cambridge University Press), 1958. Pp. vii + 360. Price 35 sh.

Symposia of this type are of interest to workers belonging to different disciplines. The success in chemotherapy, though phenomenal, has, so far been entirely due to accidental discoveries or empirical studies. The comparative failure of logical chemotherapy is due to the gaps in our knowledge of metabolism of both host and invaders and our neglect of the responses of the host.

Since chemotherapy is based on the interaction of chemical substances with biological systems, the introductory chapter by Woods and Tucker initiates the discussion by a presentation of the biochemical principles which could profitably be investigated for successful chemotherapy. The need for the discovery of new and effective antibiotics, the future potentialities of random methods and controlled biosynthesis techniques are discussed by Woodruff and McDaniel in the 'Antibiotic Approach to Chemotherapy'.

Selective inhibition of bacterial cell-wall synthesis, surface active bactericides, membrane penetration and therapeutic value of chemicals, inhibitors of energy supplying reactions, metal binding agents in chemotherapy, the designing of antimetabolites, lethal synthesis and specific inhibitors of protein synthesis, are the titles of some papers in the symposia. They present in

detail the possible methods by which the microbes in general may be attacked and offer the explanation for and prospects of their selective action against the microbe.

The remaining papers deal with particular problems of certain groups of micro-organisms and include the selective inhibition of viral multiplication, the chemotherapy of bacterial infections, fungal diseases, of some protozoal infections and of factors affecting the chemotherapy of amœbiasis.

Besides presenting a critical and exhaustive survey of the present-day chemotherapeutic approach, a significant feature of the symposia has been the emphasis laid on the need for accumulation of more fundamental data and the high optimism of the contributors in the future success of rationale approach to chemotherapy.

M. SIRSI.

---

**Yeasts.** Edited by W. Roman. (Dr. W. Junk, Publishers, Hague), 1957. Pp. 246. Price 25 Guilders.

*Yeasts* is the first volume of the series in *Biologia et Industria* planned with the laudable object of bridging the gulf between academic research and industrial practices. The biology, biochemistry and technology of Baker's, Brewer's, Wine, Sake, Food and Fodder Yeasts are given. The contributions, however, are not of the same standard. The classification into Brewer's and Baker's yeasts is arbitrary since they are only varieties of *Saccharomyces cerevisiae*. The treatment of the subject on the old empirical classification has led to repetitions in different sections.

The references given in most chapters end with the year 1954 though the book was published in 1957. The section on Cytology and Cytochemistry which may appear objective to a lay reader is vitiated by an incorrect appreciation of the earlier literature. The first report on the presence of a nucleus in yeast (Nageli, 1944), was from living cells. A vesicular nucleus with a nuclear membrane was described as far back as 1896 from living as well as stained cells. Confirmation of these discoveries have been published in 1956. And yet the suggestion is offered that like the naked chromosomes of bacteria, "the discrete granules revealed by ultraviolet microscopy may, in fact, represent the true condition of the nuclear apparatus of a yeast cell" (p. 43).

The get-up of the book is good but the large number of printer's devils and even displace-

ment of portions of sentences (pp. 107, 108, 109) may irritate a reader. The chapters on Wine, Sake, Food and Fodder Yeasts are claimed by the publishers to be the outstanding features of the book.

M. K. SUBRAMANIAM.

**Cosmetics : Science and Technology.** Edited by Edward Sagarin. (Contributions by sixty-one authors.) (Interscience Publishers, Inc., New York-1 ; 88/90, Chancery Lane, London, W.C. 2), 1957. Cloth bound, Royal 8vo. Pp. xix + 1433 including indices and bibliographies. Price \$25.00.

The last two decades have witnessed an ever-increasing number of authentic and original publications in English language dealing with almost every branch of advanced scientific and technological subjects. But the recorded literature in cosmetic science lags far behind its actual progress in research and technology. With the three notable exceptions by M. G. de Navarre and R. G. Harry, published in English in the early 1940's and followed later by two Cosmetic Compendia by E. G. Thomssen and S. P. Jannaway, the cosmetic chemists and the manufacturers had no other source to fill the serious gap of advanced scientific information on cosmetics. The latest publication of this heavy volume is, therefore, not only opportune, but also most welcome.

By contrast, the Editorial Board of this volume including, besides the celebrated author and executive, Edward Sagarin, three eminent cosmeticologists, viz., H. D. Goulden, E. G. Klarmann and Donald H. Powers, felt the need for a work of collective nature. In their preface to the volume, the learned editors have very aptly pointed out the limitations of some chemists who are well versed in certain types of cosmetics, but may possess comparatively little knowledge of others. Out of this realisation, by the Board of Editors, grew their determination to bring together a number of authorities each of whom has an established reputation for familiarity with some special phase of cosmetics, or of some related science or technique. Thus, has emerged the first collective volume in the history of cosmetic literature, compiled by the team contributions of fifty-three separate chapters by a galaxy of sixty-one men and women engaged in research and industry in the field of cosmetics. To add further to the thoroughness of the scientific and technical information contained in this volume, the Editorial Board deserves to be highly com-

plimented for having liberally drawn upon their resourcefulness in having several chapters reviewed by a large number of leading scientists and technologists in the field of cosmetology.

The volume is suitably divided into five main sections, viz., (i) three chapters dealing with the Scope of Cosmetics ; (ii) Toilet preparations described in thirty-five groups of different types of cosmetics ; (iii) Manufacture and technology covering six chapters ; (iv) Physiological considerations condensed into five chapters, and lastly (v) Legal considerations in four chapters. With such a vast and diverse scope and extent of its contents, this volume is, on the whole, an excellent addition to the rather scanty literature on cosmetics in English and is also very reasonably priced. Clear photographic illustrations, flawless printing and get-up and a strong binding have left nothing desired. A larger number of photographs and suitable flow-sheet diagrams of the chemical engineering operations could not perhaps be included due to the otherwise heavy bulk of the volume.

The three chapters in Part I on the Scope of Cosmetics are, on the whole, most thought-provoking and illuminating. Aptly sandwiched between a concise account of Definitions and Limitations by Hugo Mock and a masterly account of the Status and Structure of the Cosmetic Industry by Edward Sagarin, is a very fascinating historical account on the Origin and Development of Cosmetic Science and Technology by its erudite and learned writer, Miss Florence E. Wall. This chapter with its eighty-eight references gives a precise wealth of information on the early history of Cosmetics, and is the best that the reviewer has ever come across on the subject. References to early history of cosmetics in India are also aptly and intelligently included.

The individual Toilet Preparations described in detail in Part II of the volume, are impressive illustrations, not only of the magnitude of the cosmetic industry but also of the exacting task undertaken by their respective writers. Edward J. Master's contribution on Cleansing Creams and Lotions, spread over seventeen pages, gives a lot of useful information. Cold Creams have, in fact, been very well treated though, as it appears, at the cost of Lotions. Forty-seven pages have been ably contributed by Gabriel Barnett on the subject of Emollient Creams and Lotions, their formulation and manufacturing details. On the whole, this chapter makes a very informative reading. This is followed by an excellent chapter on Hand

Creams and Lotions by S. J. Strianse. In thirty-five pages of this chapter, the writer has classified the various ingredients used in the formulation of hand preparations according to its most specific feature and has offered very balanced and thoughtful comments. C. W. Ozier's short chapter on Skin Lighteners and Bleach Creams is as interesting as brief. Jean R. L. Martin's excellent account of Face Powders, colouring methods and colour shades in vogue for these items is disappointing in respect of information on perfuming of face powders. Lauffer on Lipsticks; Gershon and others on Dentifrices; Rosenthal on Mouthwashes; Powers on Shampoos; Guest on Shaving Soaps and Creams; Bell on Preshave and Aftershave Preparations; Barry on Depilatories; Lehne on Hair Grooming Preparations; Gershon and others on Permanent Waving, etc., have all contributed as entertaining and informative write-ups as one could desire. Miss Florence E. Wall has further contributed an able chapter on Bleaches, Hair Colorings and Dye Removers. Davenport's treatment of Bath Preparations is rather sketchy. Robert F. Schuler's chapter on Emulsified and Solid Fragrances is quite impressive. However, author's reference to glycerine as a solvent for perfume oils is rather intriguing as glycerine is an exceedingly poor solvent for most of the terpene oils and aromatics. Edward Sagarin's excellent chapter on Fragrance deals effectively with the raw materials, life of a fragrance, fixation, problems of formulation, etc. Sagarin, as usual, has displayed his excellent style and mastery of facts and problems in his write-up. The chapter on Aerosol Cosmetics by H. R. Shepherd is a novel and very useful feature of the book. Over fifty pages on this subject are very well written and cover almost all the features of Aerosols for the first time in the history of cosmetic literature. Barnett's treatment of Baby Toiletries is also full of useful information.

In Part III, ably written and thought-provoking chapters on Plant Layout and Equipment, Quality Control, Performance and Evaluation of Cosmetics, Preservation of Cosmetics and Color in Cosmetics have been contributed by leading experts in the respective fields. The two chapters on Quality Control by Martin A. Brumbaugh and his colleagues and on Performance and Evaluation of Cosmetics by Dean Foster and Noel Schwartz are the outshining contributions towards much desired standardisation of cosmetics, their performance, raw material specifications, testing, sampling, etc. The authors have much enhanced

the utility of the book by their valued and scientific write-ups. This part also contains a chapter of some thirty-five pages on Emulsification by William C. Griffin. The author has given some excellent photographs depicting viscosity changes and particle size and has made a bold attempt to explain almost every phase of this complex phenomenon. The overall impression left by the author is that the subject of emulsification has never received any scientific approach and that our present knowledge is only the result of rule-of-thumb methods. The classic work of Rideal, Schulman, etc., to which incidentally no reference has been made by the author, convincingly proves that this is not so.

Part IV on Physiological Considerations comprises well-written five chapters, ably handled and full of useful information to all Cosmetic Chemists.

The information given on Legal Considerations under the concluding Part V is concise though much of it is bound to be redundant even before the first revision of the book becomes feasible.

"Cosmetics: Science and Technology" is, on the whole, an admirable venture of its kind. The reviewer wishes it all success and hopes that, before long, its copies should be in possession of all research laboratories, cosmetic chemists and manufacturers.

SADGOPAL.

#### Books Received

*Infrared Absorption Spectra of Steroids—An Atlas*, Vol. II. By Glyn Roberts, Beatrice S. Gallagher and R. Norman Jones. (Interscience Publishers, New York-1, N.Y.), 1958. Pp. viii + 95. Price \$20.00.

*Antibiotics Annual*. Edited by Henry Welch and F. Marti-Ibenes. (Medical Encyclopedia, Inc., New York, N.Y.), 1958. Pp. xvii + 1070. Price \$12.00.

*Methods of Biochemical Analysis*, Vol. VI. Edited by David Glick. (Interscience Publishers, New York), 1958. Pp. ix + 358. Price \$8.50.

*Chemical Analysis—Colorimetric Determination of Non-Metals*, Vol. VIII. Edited by David F. Boltz. (Interscience Publishers, New York), 1958. Pp. xii + 372. Price \$8.50.

*The Chemistry and Biology of Yeasts*. Edited by A. H. Cook. (Academic Press, Inc.; India: Asia Publishing House, Bombay-1), 1958. Pp. xii + 763. Price \$22.00.

---

---

## SCIENCE NOTES AND NEWS

---

---

### Chromosome Numbers of Two Common Weeds

Dr. S. W. Mensinkai reports that during the cytological work on the weeds of the College Farm, at the College of Agriculture, Dharwar, it has been possible to ascertain for the first time the haploid chromosome numbers from the flower-buds of the two common weeds: (1) *Trichodesma zeylanicum*, and (2) *Acanthospermum hispidum*. The former is an erect annual herb about 2' high belonging to *Boraginaceae*. It is a khariff weed of the medium black cotton soil flowering on the Farm at the end of December and not in the month of January, as stated by Hooker. *A hispidum* (*Compositae*) is an exotic annual herb about 2' high, covered with hairs and dichotomously branched. The plants begin to flower from August and continue upto March. It is a weed noticed in almost all dryland areas.

The flower-buds were fixed in acetic-alcohol mixture 1 : 3 and stained in iron-aceto-carmin. In *T. zeylanicum*, the haploid number counted was 12 and in *A. hispidum*,  $n = 11$ .

### Archaeological Non-Corrosion

Metal relics which have been buried in the earth for centuries have led to the evolution of a new protection against corrosion for various kinds of steelwork which is in constant contact with dampness. The archaeological finds are known now to have been preserved by the presence of vegetable tannins in the soil.

They form a coating of tannates on the metal which protects it not only against chemical corrosion, but also against the corrosive action of bacteria. A tannin phosphate has been produced to serve the same purpose for application by immersion or with a brush to things like steel pipelines, storage tanks and such steel work as is hard to reach when installed.

### New Process for Electro Refining Nickel

Research scientists and engineers of the International Nickel Company of Canada, Limited, have developed a new process for the electro-refining of nickel.

A main feature of the process is the direct electrolysis of nickel matte, an artificial sulfide. This contrasts with the usual electro-refining methods, including those employed in

the nickel industry, in which a metal anode is used. The new Inco process eliminates high-temperature oxidation and reduction operations, with attendant losses of metals and sulphur and selenium. Instead, nickel sulfide of low copper content from the Bessemer converter or other source can be cast directly into sulfide anodes and electrolyzed for the production of high quality nickel. Another unique feature of the process is that it permits, for the first time in nickel refining, the commercial recovery of elemental sulfur and selenium as valuable by-products, in addition to cobalt and precious metals conventionally recovered.

The interesting possibilities of the new method were first demonstrated in Inco Laboratory tests in 1951, when a small piece of cast nickel sulfide was electrolyzed. It corroded smoothly the nickel and other base metals passing into solution, leaving a precious metal-bearing anode sludge containing 97% elemental sulfur.

A number of obstacles to the recovery of sulfur of high purity from the sludge were resolved by laboratory and pilot plant investigations. These studies, conducted jointly with Blaw-Knox Company, resulted in the construction of a novel 100-ton-per-day sulfur fractional distillation unit. The sulfur from this unit contains less than five parts per million of selenium and has an unusually low ash and bitumen content.

### Sulfur : A Possible Metallic Form

Sulfur is normally an excellent insulator. But in spite of its high specific resistance ( $> 10^{18}$  ohm cm.) it appears to be an intrinsic semiconductor, and its position in the periodic system suggests that it might even exist in a metallic state under favourable conditions. There is evidence that its neighbour, phosphorus, undergoes a reversible change into a metallic form at about 40,000 atoms, and Bridgman has looked for a corresponding transformation in sulfur at high pressures. He found no sign of a transition below 100,000 atoms.

It is reported that sulfur subjected to shock pressures of about 230,000 atoms, exhibited strong indications of metallic conduction under these conditions. (*J. Chem. Phys*) 28, No. 5, May 58, p. 1006.)

### Extraction of Helium from Gas Mixtures

During the Fifth International Conference on Low Temperature Physics and Chemistry, held at Madison, Wisconsin, in 1957, concern was expressed because at present only a small proportion of helium is extracted from the considerable volume of helium-rich natural gas that is used as a fuel, so that a large proportion of our limited helium resources is being wasted. In a new and simple method of extracting helium that is being developed by K. B. McAfee, of the Bell Telephone Laboratories, the fact is made use of that under high pressure difference helium will diffuse fairly rapidly through a thin wall of silica or 'Pyrex' glass, especially if it is at a high temperature but not other gases.

With a pressure difference of 1,000 atmospheres, a practical cell containing capillaries occupying a volume of about 2 cu. yd. could extract from a 1% mixture about 1,000 cu. ft. of helium per day at room temperature and about 100,000 cu. ft. at 400° C. It is suggested that all the helium-rich natural gas that is collected could easily be passed through such cells. The resulting helium is very pure, and the process could also be used simply for purification.

### Electron Phase Microscope

Since the beginning of electron microscope, it has been well known that the phase contrast due to the interference of the coherent wave plays a very important role in image formation. In view of Zernike's theory of the phase difference microscope, if an appropriate phase plate is inserted into the back focal plane of the objective and, in addition, if it is possible to cause a phase difference whether in the transmitted wave or the diffracted one, it is reasonable to expect that it is possible to make a phase microscope. According to calculation, a collodion film 100 Å in thickness, is seen to result in a phase delay of the order of  $\pi/2$  provided that the accelerating potential is 60 kv. For this reason, it is necessary that the phase plate be very thin. For this phase plate, a hole in the collodion membrane or a disc on a thin collodion membrane may be suitable for dark or bright contrast observations. For several reasons however, it is seen that a phase plate with holes may be considered to be superior to that without holes.

It is shown that observation by dark contrast image using a phase plate, consisting of many holes in a carbon membrane is very suitable for microtome section specimens, as well as for thin

crystal specimens without a decrease in resolving power. (*J. App. Physics*, 29, p. 1046.)

### Contact Stresses

So many engineering devices, such as toothed gears, rolling bearings and the wheel itself, operate by the transmission of large forces between surfaces in contact over a relatively small area, that a knowledge of the local stresses set up in the region of such contacts is obviously of wide interest.

Apart from the inspired, and now classical, theory of elastic contact presented by Hertz in 1881, there have been until recently very few contributions to the theoretical structure of the subject so beloved of academic investigators. In consequence, the engineering designer has been obliged to develop his own empirical rules and to conduct his own comparative tests to avoid the undesirable consequences of excessive contact stresses: pitting, scuffing, fretting or simple wear.

The past few years, however, have seen considerable advances in the theory of contact stresses. A number of solutions have been found, arising, as so often is the case, from investigations in other fields, to the problem of contact of both ideally elastic and ideally plastic solids under the action of various systems of forces. The basis for more fundamental and revealing studies of the mechanism of surface breakdown under contact loads appears to have been laid, and it is likely that more satisfactory explanations of pitting and other surface failures are not too remote. Even the study of metallic friction and wear, which has attracted scientific work of high quality over a number of years, has benefited from recent theoretical studies.

Yet the Symposium organized by the Stress Analysis Group, and held at the Institute of Physics, on May 14, appears to have been the first in Britain to be devoted specifically to the topic of "Contact Stresses".

### Organic Tin Compound as a Crop Fungicide

The fungicidal properties of organo-tin compounds with quadrivalent tin were discovered by Van der Kerk and Luitjen and described by them in detail in 1954. They found that exceptional fungicidal activity characterised certain organo-tin compounds of the general formula  $R_1, R_2, R_3, S_n, X_1$ , where 'R' is an organic radical linked by one of its carbons to the tin atom, and 'X' is an organic or inorganic radical not linked to the tin by carbon. The nature of the hydrocarbon radicals,  $R_1, R_2$  and  $R_3$  has a decisive influence on the degree of the

fungitoxic effect but the group X has not much influence. Tributyl—and isopropyl-tin compounds have the greatest fungicidal effect *in vitro* but are strongly toxic to plants.

Following the excellent fungicidal tests with triaryl-tin compounds under natural conditions, further outdoor tests confirmed that triphenyl-tin compounds were very promising agricultural fungicides. A preparation based upon triphenyl-tin acetate, under the name 'V.P. 19-40', was given official trials in 1953-54, and, after this, it was thoroughly tested at the Biologische Bundesanstalt, Braunschweig, where it was acknowledged to be effective at 1.8 kg. per hectare (in a 0.3% spray) against *Cercospora* in beets and against *Phytophthora* in potatoes. This preparation was then registered under the trade mark "Brestan" in the catalogue of plant preservatives of the Biologische Bundesanstalt. It is now available in limited quantities to agriculture for trial purposes.

#### Thermoelectric Cooling

Locked in the laboratory since its theoretical discovery by Peltier in 1834, a practical method of producing electronic refrigeration has been the goal of scientists throughout the world. The principle is that simply passing electricity through junctions of two dissimilar metals creates heating or cooling depending on the current's direction. Until now, the problem has been to find a practical and efficient way to do this. Besides, the advantage of smaller size, the electronic method is noise- and vibration-free, simple to control and capable of almost instant temperature change at the junctions.

These devices represent a new source of cold. We clearly foresee the day not too far in the future when thermo-electric cooling will replace the conventional compressor as a 'cold-maker'.

#### A New High Temperature Alloy

A new, improved high temperature alloy known as Carpenter Lepelloy "C", has been

developed by The Carpenter Steel Company, Reading, Pa., for jet engine parts requiring excellent ductility and good impact resistance.

Carpenter Lepelloy "C" has a more homogeneous structure and more uniform fabrication behaviour and mechanical properties than the conventional Lepelloy. It is used for highly stressed parts involving service temperatures up to 1,200°F. Lepelloy "C" has greater ductility and impact strength at both room and elevated temperatures than conventional Lepelloy when heat treated to the same strength level.

High mechanical properties can be developed by heat treatment. It has good resistance to scaling and oxidation for continuous service up to 1400°F. The alloy offers best corrosion resistance when in the hardened and tempered condition. It is used for compressor wheels, turbine shafts, compressor buckets, blades, and bolts.

Type analysis of Carpenter Lepelloy "C" is: Carbon, 0.20-0.25%; Manganese, 0.65-1.00%; Silicon, 0.50% max.; Chromium, 11.00-12.00%; Nickel, 0.50% max.; Molybdenum, 2.50-3.00%; Copper, 1.75-2.25%, and Nitrogen, 0.06-0.10%. [*J. Fran. Inst.*, June 1958, 265 (6), 523 ]

#### Testing and Standardisation of Foundry Materials

Under the auspices of the Bangalore Chapter of the Indian Institute of Metals, a Symposium on the above subject will be held on the 9th and 10th October 1958, at the Indian Institute of Science, Bangalore.

#### Institution of Chemists, India

The Ministry of Scientific Research and Cultural Affairs, Government of India, have recognised the Associateship Diploma of the Institution of Chemists (India), by examination, as equivalent to M.Sc. Degree in Chemistry for all appointments.

---

927-58. Printed at The Bangalore Press, Bangalore City, by C. Vasudeva Rao, Superintendent, and Published by A. V. Telang, M.A., for the Current Science Association, Bangalore.

All material intended for publication and books for review should be addressed to the Editor, *Current Science*, Raman Research Institute, Bangalore-6.

Business correspondence, remittances, subscriptions, advertisements, exchange journals, etc., should be addressed to the Manager, Current Science Association, Raman Research Institute, Bangalore-6.

#### ANNUAL SUBSCRIPTION

India: Rs. 12-00. Foreign: £ 1-4-0. \$ 4-00



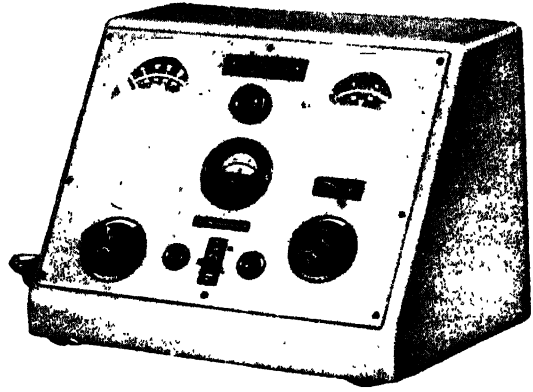
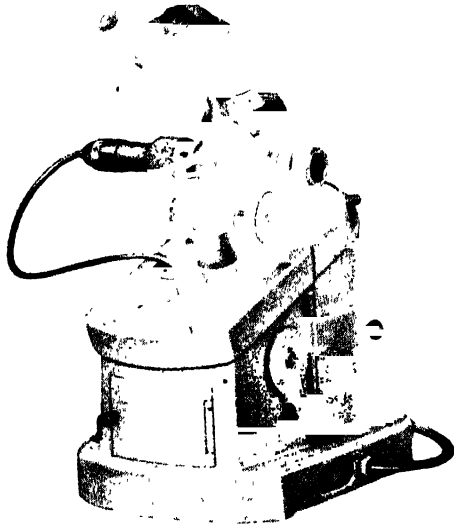

## **ZEISS ELECTROLYTIC POLISHER**

A new development which enables Metallurgists to polish, electrolytically, metallurgical samples. To watch the process under bright-field incident light, under a binocular microscope giving a magnification of 210.

To control the etching and select the required contrast. The instrument will accommodate samples 4 ins.  $\times$  2 ins.  $\times$   $1\frac{1}{8}$  ins. thick.

Power unit 220 volts A.C. controls circulation of electrolyte: regulation between 0-15 v. or 0-60 v. D.C.



VEB CARL ZEISS JENA

SOLE AGENTS

**GORDHANDAS DESAI PRIVATE LTD.**

**PHEROZSHAH MEHTA ROAD, BOMBAY 1**

P-7, Mission Row Extension  
CALCUTTA 1

Branches at :  
4/2-B, Asaf Ali Road  
NEW DELHI

22, Linghi Chetty Street  
MADRAS 1

## SCIENCE IN EASTERN EUROPE: I

SIR C. V. RAMAN

LADY RAMAN and myself left for Europe by the s.s. "ASIA" which sailed from Bombay on the 9th of May this year and docked at Genoa in Italy on the morning of the 23rd of the same month. We were in Europe for nine weeks and took the same steamer back to India, leaving Genoa on the 30th of July and reaching Bombay early morning on the 13th of August. We travelled by rail, stopping off at various places for a shorter or longer period as we thought fit. The tour gave us a wonderful opportunity of seeing the countries through which we passed and of obtaining some knowledge of their condition and activities at the present time. This article records some of my personal impressions and it is hoped that it may be of interest to readers of *Current Science*.

The countries we had arranged to visit were in Eastern Europe, but our journey to them took us through Italy and Austria. Proceeding from Genoa to Milan, a brief stop was made at the latter city where we visited the Science Museum recently set up by the civic authorities, in which a remarkable exposition of the pioneer investigations of Leonardo Da Vinci is a noteworthy feature. Travelling from Milan through Verona and the Brenner pass, we reached Innsbruck in Austria where we made an overnight stop. We found Innsbruck to be a town of great charm set in Alpine surroundings of impressive grandeur, and we were thereby confirmed in our resolution to return to it for a longer stop during our return journey. The railway took us across Austria from Innsbruck to Linz *via* Salzburg, through a region of mountains, lakes and valleys of entrancing beauty. At Linz we made an overnight stop, and left next morning for Prague which we reached on the afternoon of the 27th of May.

### 2. PRAGUE

A feature that impressed us during the journey through Czechoslovakia was the meticulous attention given to agriculture, not an acre of land, so far as we could see, escaping the attention of the cultivator. It was also obvious that we were passing through a highly industrialised country. It did not therefore surprise us to discover when we arrived at Prague that Czechoslovakia pays much attention to advanced studies in science and technology and that research is assiduously pursued.

The Czechoslovakian Academy of Sciences played the host to us at Prague. The Academy had placed a young spectroscopist—Dr. Josef Pliva—on special duty to take me around and he carried out the assignment with energy and enthusiasm. Indeed, the five days of our stay at Prague were crowded with activity. Formal receptions, social engagements, visits to the Research Institutes of the Academy and to the Laboratories of the Technical University and excursions to places of interest around Prague filled up most of the time. I also delivered two lectures at the Physical Institute of the Charles University, the first on "The Specific Heats of Crystals", and the second on "The Physics of the Diamond".

It is not possible here to summarise all that I saw of the scientific life of Czechoslovakia or even to mention the many distinguished men of science with whom I conversed and discussed scientific problems during my stay at Prague. The barest reference to a few items must suffice. I was highly impressed by my visit to the unpretentious laboratory of Professor Jaroslav Heyrovsky, famous as the founder of the polarographic method in physical chemistry. He received me most cordially and expound-

ed for my benefit the basic principles of the subject.

At the Institute of Technical Physics of the Academy, I saw much of interest, a notable item being the preparation of a rod of pure silicon which was in progress. During my visit to the Technical University, I was much struck by the excellence of the mineralogical museum which I saw on one of its floors. The museum was a wonderful collection of beautiful specimens from all parts of the world arranged and exhibited in a

of optical instruments made from quartz. A demonstration was given to me of the performance of the so-called birefringent filter made of quartz plates which finds application in astronomy.

### 3. MOSCOW AND LENINGRAD

We were at Moscow from the 4th to the 7th of June, and again from the 11th to the 14th of the month, the interval of three days from the 8th to the 10th being taken up by a brief visit to Leningrad. The time thus



FIG. 1. Professor Heyrovsky in the garden of the Polarographic Institute.

remarkably perfect fashion. Finally, I should mention my visit to the Institute for Research in Minerals situated in Tournay about seventy kilometres from Prague. The journey was made by motor through a beautiful landscape known locally as the Czech Paradise. I found that an important section of the Institute was devoted to the synthetic production on a large scale of crystals required for the electrical and other industries. There was also a section devoted to the cutting of quartz and the fabrication

devoted to these two great centres of scientific activity was, of course, much too short to enable them to be adequately explored. Even what I saw was sufficient, however, to impress upon me the vast scale on which scientific advance is encouraged and supported by the U.S.S.R.

The Institute for Physical Problems directed by Academician Peter Kapitza was the very first to be visited by me. That Institute specializes in the production of low temperatures and the study of the physical

properties of matter at such temperatures. I utilized the facilities available in it for making some preliminary studies on the luminescence spectrum of diamond held at liquid helium temperature. A highly interesting forenoon was spent at the Institute of Crystallography where I was welcomed with special enthusiasm by Academician Belov and his collaborators. A striking exhibit had been there arranged for my benefit of moving films exhibiting the growth of crystals as well as the order-disorder phenomena observed in them. During my return visit to Moscow, I delivered a lecture at the Institute of Prof. Kapitza on "The Thermal Energy of Crystals". On the 12th of June, I was officially received by President Nesmeyanov and his staff at the administrative offices of the U.S.S.R. Academy of Sciences. The next evening, at his invitation, I delivered in the conference room of the Academy a lecture on "The Dextro and Lævo Forms of the Carbon Atom", standing beside a gigantic portrait in oils of the great Russian chemist, Mendeljeff. The Lebedev Institute of Physics directed by Professor Skobelcyn and the grandiose building of the University of Moscow and its Institute of Physics were also visited.

One day of my brief visit to Leningrad was utilized for a call at the Institute of Semi-conductors directed by the celebrated Russian physicist, Academician Joffe. I was there shown the thermoelectric batteries and the thermoelectric refrigerators which had been developed in the Institute as practical applications of thermoelectricity. On another day, the well-known observatory at Pulkovo near Leningrad directed by Academician Mikhailov was visited. The observatory which had almost been completely destroyed during the war had been reconstructed and is functioning once again. During my tour of the observatory buildings, I was shown a new type of coronagraph which had been developed at the observatory. It was evident from what I saw at Pulkovo and else-

where that great advances in optical technology had been made in the U.S.S.R. and that in the production of optical instruments such as spectrographs, gratings, large mirrors and lenses, the U.S.S.R. is now completely self-sufficient.

#### 4. KIEV

We were at Kiev from the 15th to the 18th of June. This city, the capital of the Ukraine, is beautifully situated on an elevation overlooking the river Dneiper. It has been almost completely reconstructed after the war and but little evidence remains of the destruction caused by the latter. Civic pride is manifest in the tidiness of the roads and the beautifully kept boulevards and gardens.

Though our visit to Kiev was very brief, it was full of interest. The Ukraine has its own Academy of Sciences. At some little distance from the city a new Institute of Physics has been built and equipped which is devoted for the most part to nuclear studies. I was very warmly received by its Director, Academician Pasechnik and his colleagues and went round the laboratories. In the auditorium of the Institute which was filled to capacity, I gave a lecture on the theory of the atomic vibrations in crystals. On the afternoon of the same day, I delivered a semi-popular address in the hall of the University of Kiev describing the results of the Bangalore investigations on iridescent minerals. The various departments of the University were visited later the same evening. The next morning, I went round the Institute of Metals conducted by the Academy and was greatly impressed by the wide range of the problems being investigated by its staff. Here, again, I gave a lecture on "The Diffraction of X-Rays by Diamond". In the afternoon, I visited the Institute of Physical Chemistry of the Ukrainian Academy of Sciences and had a long conference with Academician Brodsky and his colleagues in which problems of common interest to us were discussed.

## 5. BUDAPEST

Many years ago, before the war, I had been at Budapest for a fortnight. Seeing it again, it was evident that the scars left by war had not all been effaced. Nevertheless, Budapest was beautiful as ever, standing as it does astride the Danube and with the hills overlooking it. We were very happy to be able to devote ten days for our visit to Hungary. The Magyars—as they call themselves—are a gifted people fully capable of rising to great heights of achievement in all the realms of knowledge.

outline of the activities currently in progress under the auspices of the Academy and at the different universities in Hungary. An outstanding recent development has been the establishment of a Central Physical Research Institute—with ten departments—under the auspices of the Academy with Prof. L. Janossy as Director. Prof. Janossy was away in China on a lecturing tour when I arrived at Budapest. Fortunately, however, he returned in time to be able to take an active part in a meeting of the Hungarian Physical Society held on the 27th June. One



FIG. 2. Tihany and Lake Balaton.

The Hungarian Academy of Sciences played the host to us and we had a wonderfully interesting time. A young spectroscopist, Dr. Laszlo Szalay, Lecturer in Physics in the University of Szeged, was on special duty to look after us and make all the necessary arrangements. Dr. Szalay had prepared for my perusal a highly informative account giving us a complete picture of the state of physics in Hungary and a brief

of the items on the programme of this meeting was a lecture by me on "Physical Research in India". I spoke in English and Prof. Janossy gave a fluent running translation of my speech into Hungarian. Besides this lecture, I gave a systematic course of three lectures on "The Physics of Crystals" under the auspices of the Hungarian Physical Society. These lectures were attended by a large and distinguished audience and every

lecture was followed by a vigorous discussion. The rest of my time was fruitfully spent in visits to the Central Physical Research Institute referred to above and to the various other laboratories in Budapest including especially that directed by Prof. Z. Gyulai—the doyen of Hungarian physicists—which concerned itself with crystal physics and the Research Laboratory of the Tungsten Lamp Industry directed by Dr. G. Szigeti. I witnessed fascinating demonstrations of the work in progress in both of these Institutes.

Limitations of space prevent my giving a fuller account of the scientific activities in Hungary which I witnessed and referring to the other distinguished men of science whom I was privileged to meet and discuss scien-

tific problems with. This account of my sojourn in Hungary would however be incomplete if I do not at least mention the Lake of Balaton and Tihany where we stayed on Sunday, the 21st of June—a lovely beauty spot as can be seen from the picture reproduced. The day before we left for Rumania, Dr. Szalay took us on a motor ride across Hungary to visit his own University of Szeged. The physicists of the University were mostly away attending the meetings at Budapest. But we had the pleasure of visiting Dr. Szalay's own home and of a short conference with the theoretical physicist, Dr. János Horváth on subjects of common interest to us.

(To be continued)

---

#### GOLDEN JUBILEE OF THE INDIAN INSTITUTE OF SCIENCE, BANGALORE

**T**HE Indian Institute of Science at Bangalore owes its origin to the munificence of the late Mr J. N. Tata and his sons. The establishment of the Institute in 1909 was a notable event in the history of the development of facilities for advanced scientific studies and research in the country. The Government of Mysore and the Government of India have throughout been identified with the growth and development of the Institute. Its activities began with the Departments of Chemistry and of Electrical Technology. Sir C. V. Raman, the first Indian Director of the Institute, started the Department of Physics in 1933. His connection with the Institute for 15 years, till 1948, will long be remembered.

Since independence, with the Prime Minister's well-known enthusiasm for scientific advancement, and with the realisation of the important role of science in the country's industrial and engineering developments, the Union Government have been taking a keen interest and the increased grants given by it have led to a rapid expansion of the activities of the Institute. There are now 17 departments, each having its well-equipped laboratories and a highly qualified staff. There are 150 members on the staff and the number of students is about 400. Under the

various programmes sponsored by the Ministry of Education, such as Technical Co-operation Mission, Colombo Plan, etc., the Institute gets the advantage of visiting professors and research workers from abroad. In addition to research and advanced training in all the departments, many of them have post-graduate teaching courses leading to degrees like B.Sc. in Aeronautical Engineering, B.Sc. in Metallurgy, B.E. and M.E. The Institute confers also research degrees, viz., M.Sc., Ph.D. and D.Sc.

Since the Institute was established in 1909, it is proposed to hold the Golden Jubilee of the Institute in February 1959. The whole of 1959 will be the Golden Jubilee Year of the Institute. The President of India, who is the Visitor of the Institute, has graciously consented to inaugurate the Golden Jubilee Celebrations early in February 1959. Throughout the year there will be a number of symposia on various topics of scientific and engineering interest. It is proposed to bring forth a number of publications and to organise an Exhibition during the year. We look forward to an era of vigorous development of the Institute under the leadership of its present Director who has a rich background of experience, alike in the fields of scientific research and of educational administration.

---

## INFORMATION THEORY AND SOME OF ITS APPLICATIONS

B. S. RAMAKRISHNA

*Department of Electrical Communication Engineering,  
Indian Institute of Science, Bangalore*

## INTRODUCTION

IT is difficult to trace the precise origins of many scientific theories. With information theory, sometimes called communication theory, one need not go back farther than the twenties when Nyquist and Hartley tried to develop a quantitative measure of information to assess the capacities of telecommunication systems. It is only during the last decade or so, however, that a theory of information has been developed and its concepts have found widespread use outside telecommunication engineering. Norbert Wiener, to whom the basic philosophy of modern information theory is due, was the first to recognize the universal character of the communication problem encountered not only in telecommunication systems but also in living beings and social organizations. We read in his book on Cybernetics a panoramic description of the growth of these ideas against the background of the problems of the last war. A little later, in 1948, Claude E. Shannon of the Bell Telephone Laboratories published his clas-

telecommunication engineering before their use in other fields is considered. We shall lean heavily on Shannon's work in introducing the current notions of communication theory.

## ANATOMY OF TELECOMMUNICATION SYSTEMS

In the interests of a general theory of communication we must abstract from the wide variety of communication systems the essential features which they all have in common. Every communication system is primarily a device for transmitting messages from their sources to their destinations. These messages may be spoken words with an acoustic pressure-time pattern as in telephone conversation, written characters as in telegraphy or the colour and intensity patterns of light from an object being televised or any other set of symbolic patterns. They may even be numerical data relating to some physical quantity such as temperature or density under observation. A very successful model of a general communication system, due to Shannon, may be represented schematically by the block diagram of Fig. 1.

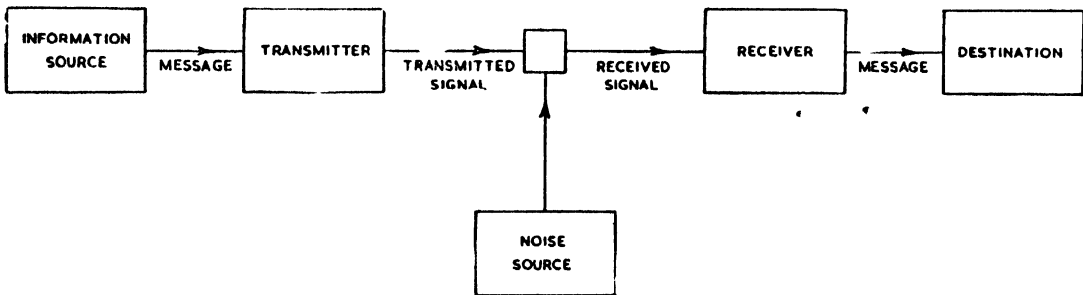

FIG. 1.

sic papers on the mathematical theory of communication. Although Shannon was concerned in his work primarily with the telecommunication problem, the mathematical model he set up for a communication system has been found to be useful in many different disciplines and the concepts of communication theory have penetrated into fields as far away as linguistics, psychology, neurophysiology and others. Today, ten years later, the domain of information theory extends far beyond telecommunication engineering and some of its most interesting problems lie just on the boundaries of telecommunication and other sciences. Nevertheless, in an expository account it is desirable to develop the fundamental concepts of information theory within the confines of

Operationally, we may characterise the different elements in this system as follows:

Ignoring all questions concerning the motivation of the messages, we may regard the function of the information source is to generate sequences of symbols or patterns which constitute the messages. We shall first deal with discrete sources which use only a discrete set of symbols like the letters of the alphabet and then take up continuous sources which produce continuously variable patterns like those of the speech-waves. The messages ordinarily used in practice convey a meaning because of the fact that the symbols used, i.e., the written words, spoken sounds, etc., are associated with certain concepts, but we must here make a distinction between the *significant*, the symbol and the

signifie, the entity which is symbolized. In the development of the telecommunication theory, the semantic aspects of the messages were set aside as the engineering of communication systems does not depend upon the meaning of the messages and much less upon their motivation. We should thus look upon messages which communication systems handle as an ensemble of sequences of symbols. It is the statistical rather than the semantical aspects of the messages that concern us. We are thus led to regard an information source as a stochastic or a Markoff process generating its messages symbol after symbol.

In electrical communication the original message symbols are frequently converted into a different set of symbols more suitable for transmission over the communication medium or channel. In telegraphy the letters of the message are converted into the sequence of dots and dashes for signalling according to the Morse code; in telephony the acoustic wave is converted into the corresponding electrical signal. In the above representation the transmitter which may involve a human operator thus performs the operation of producing the sequence of signal symbols at its output from the message symbols fed to its input. Functionally, the transmitter is an operator which maps the message space on the signal space.

The intervening medium between the transmitter and the receiver is called the channel. The channel may be susceptible to noise in which case the signal reaching the receiver differs from the transmitted signal. The noise, like the message, may be regarded as the output of a stochastic or a Markoff process. For instance, the noise in a pair of telephone wires may be due to cross-talk from an adjacent pair. It may be simply due to the random thermal motions of the electrons in the circuit elements. In any event, the effect of noise is to alter the signal in an unpredictable manner except in a statistical sense. It will be seen that the ability of a channel to transmit messages depends upon the band of frequencies it can transmit (the bandwidth of the channel) and the level of the signal relative to that of the noise.

The function of the receiver is to reconstruct the original message from the received signal and hence it may be thought of as an inverse operator to the transmitter. If the received signal is badly perturbed by noise, correct reconstruction of the message from the received signal may not be possible and there remains some uncertainty about the original message.

The destination is obviously the terminating point for the message and may be a recording device like a photographic film or a magnetic tape or even a human sense organ like the ear or the eye. It comes into consideration here because the resolving power of the terminating device determines the degree of detail that we need transmit

#### A MEASURE OF INFORMATION

Having described the basic elements of a generalized communication system we proceed to develop the fundamental concept of information. When we ignore the meaning and look at the message as the output of a stochastic process (as a cryptanalyst does when deciphering a cryptogram) we begin to notice that the various symbols of the message (letters, etc.) are not entirely random but exhibit certain statistical regularities such as the constant frequencies of the letters, etc. The statistical properties as defined, for instance, by the probabilities of the occurrence of the different symbols, the transition probabilities between successive symbols, etc., enable us to define a quantitative property of the message called the information content or entropy of the message. We are certainly not using the word information here in an unconventional sense although we intend to attach a numerical measure to the information contained in the message. To be sure, the information content of a message is not the same thing as its meaning; meaning or rather its comprehension has a subjective side while the information is a measurable quantity without reference to the meaning of the message.

To develop a quantitative measure of information consistent with its commonsense usage, notice that we seek information only when we are in doubt, which arises when there are a number of alternatives or choices and we are uncertain of the outcome of the event. We go to an enquiry office (rightly called information office in America) to remove our doubts; we consult weather forecasts for information whether it will be rain or sunshine; we are, in fact, seeking information (in the form of data) when we perform experiments whether they are launching of sputniks or the testing of nuclear weapons. On the other hand, if an event can happen in only one way, there is no choice or uncertainty about it and no information is called for either. Obtaining information is equivalent to making a choice thereby removing the *a priori* doubt. Choice, uncertainty or doubt and information thus, all come to possess the same measure.



Any written message in English can thus be regarded as the result of a sequence of different choices from the 26 letters of the English alphabet. It will be convenient to regard the space between words as a symbol by itself and consider the alphabet to have 27 letters instead. We can thus form no more than  $27^N$  different messages of  $N$  symbols length. Only a very tiny fraction of these correspond to the conventional use of English and are thus used in preference to the others. What is more, we can associate with each message a certain *a priori* probability if we have sufficient knowledge of the statistics of the message symbols, *i.e.*, their probabilities, etc.

How much information does a given message contain? First, we need a unit to measure information and then the probability measure of the message. The most elementary type of choice we have is the choice between two equally probable alternatives (*e.g.*, the choice between the heads and tails in the tossing of a coin). For reasons which will become more convincing as we proceed, we shall choose the logarithm to the base 2 of the number of alternatives as the amount of information  $H$  associated with the choice so that, in the binary choice referred to above, we obtain one unit of information ( $H = \log_2 2 = 1$ ) which is designated as a bit. If there are  $N$  equally probable alternatives, we obtain  $H = \log_2 N$  bits of information with the specification of any one of them. In this case since the probability of any of the alternatives is  $p = 1/N$ , the definition is equivalent to choosing the negative logarithm of the probability of the event as the measure of the information associated with the selection.

The various symbols, however, do not occur with equal probability (the letter *e* has the highest frequency of occurrence, about 13% and *z* has the least, about 0.09%). If different symbols have different probabilities  $p_i$  ( $i = 1, 2, \dots, n$ ), and occur independently of each other, the average amount of information per symbol (of the event  $x$ , say), may be shown to be given by

$$H(x) = - \sum p_i \log_2 p_i \text{ bits.} \quad (1)$$

The only requirements imposed by Shannon in obtaining this measure are that (i)  $H$  should be a continuous function of the  $p_i$ s, (ii) when all the  $p_i$ s are equal, *i.e.*, each  $p_i = 1/n$ , it should be a monotonic increasing function of  $n$ , and (iii) that if the choice be made in successive stages, the weighted sum of the individual values of  $H$  associated with each stage must be equal to the value of  $H$  obtained by

direct selection. Notice, however, that the expression (1) can be interpreted as the weighted average of the information obtained with the selection of each symbol, the weight factor being the probability  $p_i$  of the symbol. The formal resemblance of this expression for the amount of information to the entropy of a thermodynamical system which can have  $n$  different complexions with probabilities  $p_i$  cannot escape notice here. For this reason the term entropy is frequently used to refer to the average amount of information associated with a set of alternatives.

We digress for a short while here to examine the stochastic character of actual messages. Shannon and Miller have given striking demonstrations of how we approach actual languages by merely choosing successive letters or words incorporating longer and longer probability constraints in their choice (see references 1 and 8).

A typical 'sentence' of zero-order approximation is obtained by choosing all the letters with equal probability and independently:

XFOML RXXHRJFFJUF ZLPWCFWKCYJ  
FFJEYVKCQSGXYD QPAAKKBZAAACI-  
BZLHJQD

The first order approximation is obtained by choosing the letters independently but with frequencies as in English:

OCRO HLI RGWR NMIELWIS EU LL  
NBNESBYA TH EEI ALHENHTTPA  
OQBTTVA NAH BRL

The second order approximation incorporates the transition probabilities between successive letters and hence has the same digram (*i.e.* letter-pair) frequencies as in English:

ON IE ANTSOUTINYS ARE T INCTORE ST  
BE S DEAMY ACHIN D ILONASIVE  
TUCCOWE AT TEASONARE FUSO TIZIN  
ANDY TOBE SEACE CTISBE

The third order approximation ensures correct trigram structure:

IN NO IST LAT WHEY CRATCIT FROURE  
BIRS GROCID PONDENOME OF DEMON-  
STURES OF THE REPTAGIN IS REGOA  
CTIONA OF CRE

Higher order approximations with letters cannot be constructed due to lack of statistics regarding tetragrams, etc., but Miller, following Shannon, used words instead of letters and constructed approximations up to the seventh order.

Zero Order: BETWIXT TRUMPETER PEB-  
BLY COMPLICATION VIGOROUS TIPPLE  
CAREEN OBSCURE ATTRACTIVE CON-  
SEQUENCE EXPEDITION PANE UN-  
PUNISHED

*First Order*: IS TO WENT BIPED THE OF  
BEFORE LOVE TURTLEDOVES THE  
SPINS AND I OF YARD THAN ASK  
WENT GREEK YESTERDAY

*Second Order*: SUN WAS NICE DORMI-  
TORY IS I LIKE CHOCOLATE CAKE BUT  
I THINK THAT BOOK IS HE WANTS TO  
SCHOOL THERE

*Third Order*: FAMILY WAS LARGE DARK  
ANIMAL CAME ROARING DOWN THE  
MIDDLE OF MY FRIENDS LOVE BOOKS  
PASSIONATELY EVERY KISS IS FINE

*Fourth Order*: WENT TO THE MOVIES  
WITH A MAN I USED TO GO TOWARDS  
THE HARVARD SQUARE IN CAMBRIDGE  
IS MAD FUN FOR

*Seventh Order*: SAID THAT HE WAS  
AFRAID OF DOGS MARKED WITH  
WHITE SPOTS AND WITH BLACK  
SPOTS COVERING IT THE LEOPARD  
DID

These were obtained as follows: To obtain the third order approximation, for instance, Miller chose the sequence of the first two words from a text and asked a person to supply the next word to form a sentence so that the transition from the first pair of words to the third takes place as in common English. This word is noted along, the first word is concealed and the last two now given to another person and the next word obtained. The process is repeated using different persons every time a word is obtained. The other approximations are constructed in a similar manner. The resemblance to natural English increases at each stage although the messages are not purposive and motivated and thus strengthens the conviction that natural languages can be represented by sufficiently complex stochastic processes.

The examples above show that the first order approximation which takes only the letter frequencies into account is a rather poor one for real languages. The expression for the entropy can, however, be generalised readily to include constraints between symbols. If the choice of each letter depends upon the preceding one and only on that, we can define the entropy per symbol from digrams of the type  $ij$  as

$$H = \frac{1}{2} H(xy) = -\frac{1}{2} \sum_{i,j} p(i,j) \log_2 p(i,j) \quad (2)$$

where  $p(i,j)$  is the probability of the digram  $ij$  or as

$$H = H_x(y) = -\sum_i p(i) \sum_j p_i(j) \log_2 p_i(j) \quad (3)$$

where  $p_i(j)$  is the transition probability from the  $i$ th symbol to the  $j$ th and  $p(i)$  is the probability of the occurrence of the  $i$ th symbol.

The extension to the case where the choice of a symbol depends upon the preceding  $n-1$  symbols is now obvious. We obtain the average entropy per symbol by considering the probability of blocks of  $n$  symbols or the transition probabilities from blocks of  $n-1$  symbols length to the next one. We may also interpret the relation (3) as the average entropy of the second symbol weighted in accordance with the probability of occurrence of the first. As the information obtained is the same as the uncertainty removed, it also measures how uncertain we are, on the average, of the next symbol knowing the previous one. More generally it is called the conditional entropy of the second event  $y$  relative to the first event  $x$  and is denoted by  $H_r(y)$ . The expression

$$H(x,y) = -\sum_{i,j} p(i,j) \log_2 p(i,j)$$

may likewise be interpreted as the entropy or uncertainty of the joint event  $xy$ .

#### SOME PROPERTIES OF THE INFORMATION MEASURE

We shall now exhibit some properties of the measure of information which support the claim that the entropy of a set of probabilities (as defined above) measures the choice or the uncertainty associated with them in accordance with our intuitive requirements:

(i) If there are  $n$  possible ways an event can happen with probabilities  $p_1, p_2, \dots, p_n$ , then the entropy  $H$  is a maximum when all the  $p_i$ s are equal as may be seen by maximizing  $H$ . This is obviously the most uncertain situation.

(ii)  $H$  vanishes when all the  $p_i$ s are zero except one which is unity. There is no choice, no uncertainty and no information either.

(iii) It may be shown from our definitions of  $H(x)$ ,  $H(x,y)$ ,  $H_r(y)$ , etc., that the relations

$$H(x,y) \leq H(x) + H(y) \quad (4)$$

$$H(x,y) = H(x) + H_r(y) = H(y) + H_x(x) \quad (5)$$

and hence

$$H_x(y) \geq H(y), \quad H_y(x) \geq H(x) \quad (6)$$

hold good.

The first of these states that the amount of information (or the uncertainty) of the joint event  $xy$  is equal to or less than the sum of the informations (or the uncertainties) associated with the individual events  $x$  and  $y$ . The second relation means that the uncertainty of the joint event  $xy$  is equal to or less than the uncertainty of the event  $x$  plus the uncertainty of the event  $y$  knowing  $x$  and vice versa. The last statement asserts that the uncertainty  $H_x(y)$  of the event  $y$  knowing the event  $x$  is equal to or less than the uncertainty of  $y$

without a knowledge of  $x$  and *vice versa*. The equality obtains when  $x$  and  $y$  are independent events.

#### REDUNDANCY

These considerations regarding the entropy of a message lead us to the important concept of redundancy, a knowledge of which enables us to design suitable codes for transmission of messages. We have seen that the entropy is a maximum when all the symbols are independent and equiprobable. In English language the maximum entropy per symbol would be  $\log_2 27 = 4.76$  bits (corresponding to the zero-order approximation), but the entropies calculated on the basis of letter, digram and trigram frequencies turn out to be 4.03, 3.31 and 3.10 bits per symbol. There is evidence that if we consider constraints extending over longer sequences, the entropy reduces down to about 1.5 bits per symbol. The ratio of the actual entropy obtained in a given message to the maximum possible entropy is called the relative entropy and one minus the relative entropy the redundancy in the message. The farther the possibilities  $p$  are removed from the equiprobable case, the greater is the redundancy, the extreme case being one in which all the  $p$ 's except one are zero. The letter  $u$  after  $q$  is an example of this extreme case of redundancy. In English one finds a redundancy of 15% on the basis of letter frequencies alone and about 30% on the basis of digram frequencies. Consideration of longer sequences leads to redundancies as much as 70% or more. Just as the entropy measures how uncertain we are on the average about the outcome of an event, the redundancy is an average measure of our confidence in the outcome. A highly redundant source produces less information per symbol than a less redundant source and conversely to convey the same information we need the least number of symbols when the alphabet is used without any redundancy. Redundancy, however, insures the message against misrepresentation. Any letter after  $q$  can always be corrected as  $u$ . The price we pay for securing the correct transmission is an increase in the length of the message and the resulting slower rate of transmission.

The immediate significance of redundancy to the telecommunication problem lies in the fact that some of the redundancy may be removed in the process of encoding the message into the signal for transmission. A code is a unique correspondence between the message symbols and the signal symbols or between groups of

them in a one-to-one fashion. There are, however, severe restrictions set by noise and the inevitable delays in encoding on the extent to which the redundancy in a message can be removed.

#### RATE OF GENERATION OF INFORMATION AND CHANNEL CAPACITY

When we realise that the generation of each of the message symbols requires a finite time, we can also define the time rate at which information is produced by the stochastic process. If the durations of the different symbols are  $t$ , then the average rate of generation of information is

$$H' = H / \sum p_i t_i \text{ bits/sec.} \quad (7)$$

i.e., the average entropy per symbol divided by the average duration of the symbols. The rate of transmission of information over the channel is likewise determined by the duration  $t'$  of the channel symbols constituting the signal. (We are assuming here that the physical properties of the channel permit the transmission of the signal symbols at least as fast as they are produced.) This rate is not necessarily the maximum possible rate at which information can be transmitted over the channel with the given set of channel symbols as these may not be occurring with the optimal frequencies. The channel capacity is defined as the maximum rate at which information can be transmitted over the channel, given the durations of the channel symbols and the constraints that must be obeyed. This capacity rate of transmission is to be achieved by suitably assigning the probabilities of the different symbols and their transitions with due regard to their duration. One of the basic theorems of communication theory tells that there exists a code by which the output of a source producing entropy at the rate of  $H$  bits per symbol can be transmitted over a channel of capacity  $C$  bits per second at the maximum possible rate of  $[(C/H) - \epsilon]$  symbols per second and  $\epsilon$  can be made arbitrarily small. The emphasis here is on the possibility of a code by which the information produced by the source can be transmitted at the full capacity of the channel. To approach this limiting value, in general, increasingly long delays are needed in coding and decoding as longer and longer sequences have to be examined. One simple example of a perfectly matching code may be given: Let a source produce the four symbols A, B, C, D with probabilities  $1/2, 1/4, 1/8$  and  $1/8$  respectively so that the entropy works out at  $7/4$  bits per symbol

according to (1). A binary (i.e., a two-symbol) code can be construed as follows:

Write the original symbols in order of decreasing probability and divide them first into two groups (here A and B, C, D) of equal (or as nearly equal as possible) probability and assign 0 to the first and 1 to the second group. Proceed to subdivide each group and assign additional binary digits 0 and 1 in the same way to the subdivisions until each symbol is given a unique representation as illustrated below.

Message symbols		Signal Symbols
A		0
B	1st div.	1 0
C	2nd div.	1 1 0
D	3rd div.	1 1 1

It will be seen that a typical long message in A, B, C, D will result in producing the channel symbols 0 and 1 with equal probabilities so that they carry maximum information. We must remember that with such ideal coding which removes all redundancy any error in transmission cannot be corrected.

#### NOISE IN COMMUNICATION SYSTEMS

To make our discussion realistic we must include the effect of noise in transmission, which perturbs the transmitted signal in an unpredictable way. Thus if the transmitter produces the symbol  $i$  at the input to the channel, there is no certainty that it will be received as  $i$  at the receiver; all that we have are conditional probabilities  $p_i(j)$  that if the symbol  $i$  is transmitted, it will be perturbed into the symbol  $j$  at the receiving end. If the noise is not bad, the  $p_i(i)$ s will be nearly unity and all other  $p_i(j)$ s will be small, the noiseless case being the special one for which  $p_i(j) = \delta$ . Therefore, when a message is received over a noisy channel there will be some uncertainty of what the transmitted message was.

How much information is conveyed by each symbol under these conditions? Assuming for simplicity that the input symbols are independent and further that noise affects each symbol independently, we can compute the entropy input per symbol  $H(x)$  on the basis of the probabilities of the input symbols and likewise, the entropy  $H(y)$  of the output symbols. Knowing the  $p_i(j)$ s, which characterise the noise source, from previous statistics, we can also compute the conditional entropy which measures

$$H_x(y) = - \sum_i p(i) \sum_j p_i(j) \log p_i(j)$$

the average uncertainty of transmission. It is therefore proper to define the actual information transmitted over the channel as the received information  $H(y)$  less the uncertainty  $H_x(y)$  in its transmission. Thus the average information transmitted per symbol is  $H(y) - H_x(y)$  or in view of the relation (5),  $H(x) - H_x(x)$ . The latter expression may be interpreted as the amount of information sent less the uncertainty that remains of the transmitted message after the message is in hand. To use such a noisy channel to its capacity we must maximize  $H(x) - H_x(x)$  by assigning the probabilities  $p(i)$  of the input symbols in the optimal way. Roughly speaking, if all the symbols are of the same duration, those symbols which are least disturbed by noise are to be used most frequently.

#### CONTINUOUS SYSTEMS

The messages and signals discussed so far use a discrete alphabet. There are, however, messages like those due to speech-waves, etc., which are conventionally regarded as being continuous and also continuously variable. The problem of developing a measure of the information produced by such continuous messages may be approached in two different ways: The messages constitute an ensemble with a probability density measure  $p(x)$ , where  $x$  is some statistic such as the pressure amplitude of the different possible speech-wave forms at some fixed instant. For such continuous distributions Shannon has formulated the entropy as

$$H(x) = - \int_{-\infty}^{\infty} p(x) \log p(x) dx \quad (8)$$

In the continuous case also the entropy possesses the properties analogous to (i) to (iii) of the discrete distributions. A particularly interesting property of the continuous distribution is that if the standard deviation is fixed at some value  $\sigma$ , the entropy in (8) has the maximum value  $\log \sqrt{2\pi e} \sigma$ , when  $p(x)$  is gaussian, i.e.,

$$p(x) = \frac{1}{\sqrt{2\pi}\sigma} e^{-x^2/2\sigma^2} \quad (9)$$

A more practical approach to the entropy (and the channel capacity) in the continuous case is based on the fact that in practice there is a least upper bound  $W$  to the frequencies produced by any source of information. There is an important theorem, called the sampling theorem, which states that if a function of time  $f(t)$  contains only frequencies between 0 and  $W$  cycles per second, then it is completely determined by specifying its values (i.e., the

ordinates) at discrete points  $1/2W$  seconds apart. Thus we need only state a finite number  $2W$  of ordinates to specify a function over one second. Moreover, the accuracy of specification need not be greater than the resolving power of the ultimate destination or the level of the ambient noise fluctuation to which the channel may be subject. Thus both the abscissæ and the ordinates of the function can only assume discrete values. This double quantization reduces the continuous case in practice to the discrete case.

#### CAPACITY OF A NOISY CHANNEL

One of the most important contributions of modern information theory is the determination of the maximum possible rate at which information can be transmitted over a channel perturbed by white thermal noise of power  $N$ . Thermal noise of power  $N$  is characterized by the fact that its amplitudes are independent and have the gaussian probability distribution

(9) with standard deviation  $\sigma = \sqrt{N}$ . Therefore, the entropy produced by the noise source

in one second is  $2W \log \sqrt{2\pi e N}$ . Given a signal of power  $P$ , to carry maximum information it must also assume a gaussian distribution

with the standard deviation  $\sigma = \sqrt{P}$ . As the transmitted signal power and the noise power add directly during the course of transmission the received signal will have the power  $P + N$ , and will also have a gaussian distribution with

$\sigma = \sqrt{P + N}$ . The entropy of the received signal [corresponding to  $H(y)$  in the discrete

case] per second will be  $2W \log \sqrt{2\pi e (P + N)}$ . The channel capacity  $C$  is obtained by subtracting from this the uncertainty due to noise. Thus

$$C = W \log \frac{P + N}{N} \text{ bits/sec} \quad (10)$$

This is known as the Shannon-Hartley Law. Regarded as an exchange relation between the channel capacity, bandwidth and signal-to-noise ratio, it shows what is possible under ideal conditions.

#### INFORMATION THEORY OUTSIDE TELECOMMUNICATION ENGINEERING

The science of telecommunication abuts on many scientific disciplines, in particular, linguistics, psychology, neurophysiology and others not to speak of its obvious connections with certain branches of physics like acoustics and statistical mechanics. It stems out of the fact that in the telecommunication chain, the ulti-

mate source of information and the ultimate destination happen to be nearly always a human being. We are thus confronted with the problem of matching the telecommunication channel to the human channel. The concepts of telecommunication theory provide valuable analogies in the field of human communication and we can ask questions like "How is information transmitted in the human being and what are his capacities as a channel?" We have no satisfactory way of answering these questions yet but these problems are receiving attention in several fields. Models of communication in the human being, beginning with the physical stimulus and ending with the behavioural response, have been put forward following the general framework of the telecommunication systems. Some recent experimental work by Miller, Licklider, Pierce and others indicates that human beings cannot probably take in information at a rate much greater than about 50 bits per second through the sense organs like the ear and the eye. The importance of the problem of matching the telecommunication and the human channels becomes obvious when we observe that our present telecommunication systems utilize channel capacities several orders of magnitudes greater than that of the human channel. In the outline that follows (which necessarily belongs to the controversial) we can only hope to direct attention to some of the problems in this sphere. We must caution, however, that speculative hypotheses and theorizations which appear frequently in literature should not be mistaken to have any accepted standing.

#### LANGUAGE AND HUMAN COMMUNICATION

Communication by speech and writing have been going through a process of evolution long before we could extend their scope by telecommunication and form, even today, the bulk of our communicative activity. Speech or (written) language usually appears as the input and output of most telecommunication systems which is but one reason for our interest in these. Even before the development of information theory, a very considerable body of statistical data regarding the characteristics of speech and language has been gathered over a number of years. The growth of telephone systems following the development of the vacuum tube initiated systematic investigations into the physical characteristics of speech. The needs of the military for secret communication by codes and for deciphering enemy cryptograms provided an early incentive for the study of

the relative frequencies of different letter symbols, digrams, trigrams, etc. With information theory came the realization that these statistical data define a measurable property of speech and language. The point of view has also emerged that speech and language may themselves be regarded as codes for certain conceptual entities. The question of what are the principles which underlie this coding process has received some attention recently.

The first concern of information theorists with speech and language has almost always been to determine the extent of redundancy in a given message. The proper exploitation of redundancy offers one of the most hopeful means of more effective utilization of the channel capacities. Hence the search for the information bearing elements (or shortly *ibes*) of speech. The fact that some saving in channel capacity required to transmit intelligible speech may be possible was appreciated for some time. One of the most successful practical attempts in this direction was the Bell Telephone Laboratories' *Vocoder* which indicates that a bandwidth of some 300 cps. may be adequate for intelligible communication as compared with the nearly 3,000 cps. used in telephony. That speech is highly redundant has been amply established by a number of experiments with speech-waves during the last decade. The intelligibility of speech was tested on speech-sounds, syllables, and words using transmission systems which distort it in a variety of ways, e.g., by clipping off the positive and negative peaks till the wave becomes nearly rectangular, by interrupting the wave at a rapid rate, etc. Even when the wave form is severely distorted, speech retains its intelligibility to a remarkable degree, indicating the presence of a great deal of redundancy. This is not surprising as we already saw that the output of a continuous source has maximum entropy when it corresponds to white noise. It is correct, though uncomplimentary, to say that human speech fails to be informative to the extent that it falls short of noise. How much of this redundancy can be removed and how best the remaining can be utilized in a given situation are questions which will continue to engage our attention.

#### SEMANTIC AND PRAGMATIC QUESTIONS

Following Shannon's example, information theory has been developed (as we have done above) without attention to the meaning of the messages. This point of view was adequate as long as one's problems were strictly confined to telecommunication systems, but when once the human terminal is considered, we can no

longer ignore the semantic and pragmatic problems involved. Obviously, the use of the concepts of information theory in the semantic and pragmatic fields needs both clarification and caution. As one illustration, consider a message like 'The sun will rise in the east tomorrow'. One feels intuitively that the message is highly redundant because one has no *a priori* doubt about the truth of the statement and yet the statement is not redundant in the same sense that the letter *u* is redundant after *q*. The redundancy here is at the semantic level and not at the syntactic level as in the case of *u* after *q*. There is evidently a need for a more general theory of information which includes the meaning of the messages. Bar Hillel and Carnap have advanced, however, a theory of semantic information in the limited sense that their theory takes into account the concepts or the entities to which the symbols refer. It does not, however, take into account the meaning of the messages.

The problem of semantic information is not entirely separable from the information of the telecommunication problem, sometimes called the selective information to distinguish it from the semantic information. For, if we have the choice between two languages in which to transmit the same semantic information, we would naturally prefer to transmit it in the language which requires the smaller number of bits of selective information. Following this line of reasoning, in the course of their studies in Indian languages from the information theory point of view, the author and his co-workers have recently advanced the view that it is possible to compare the relative efficiencies of different languages for communication of semantic content without reference to its absolute value. To use a metaphor, translation from one language to another is a transformation of the code which leaves the semantic content, but not the selective entropy, of the code symbols, invariant. The total number of bits of selective information contained in semantically equivalent materials in different languages are thus, in a sense, the appropriate measures of the efficiencies with which different languages encode semantic content into linguistic symbols. A preliminary comparative study of English and German languages, considered as alternate codes for communication of semantic content, revealed some interesting aspects of the process of translation. On counting the number of bits of information in samples of texts in English and their translations into German, it was observed that a bit in German is semantically

equivalent to about 0.82 bits in English. On the other hand, when translations from German to English were examined, one bit in German was found to be equivalent to 0.94 bits in English. A unique ratio may, however, be obtained on the assumption that translation from one language into another involves a certain amount of ambiguity which is in the nature of noise or loss of information and therefore one uses additional bits of information in the language of translation to overcome this noise. On the basis of this assumption one finds that a bit in English has about the same semantic value as 1.15 bits in German (which makes English slightly more efficient) and that each bit requires an additional 0.065 bits to overcome the noise inherent in the process of translation. Comparative studies in statistical aspects of Indian languages from the information theory point of view also showed the possibility of a common telegraph code for the Indian languages. One may go further and regard the different scripts as different codes for the same phonetic pattern and thus compare their efficiencies for transcribing from the verbal to the orthographic form.

#### INFORMATIONAL AND THERMODYNAMIC ENTROPIES

A large part of our scientific activity may be described, in a sense, as seeking, processing and using information. A theory of information, therefore, cannot but be of some significance to science at least on the philosophical plane. Brillouin, who has some provoking statements to make, has explored the relationship between the thermodynamical entropy of a physical system and the amount of information obtained when the state of the system changes. When an isolated system is left to itself, according to the second law of thermodynamics, the system can undergo only those changes which lead to an increase in its physical entropy or a degradation of its energy. At best the entropy remains constant if the change is a reversible one. Brillouin argues that information can only be obtained by letting the entropy of the system increase and the increase in entropy is always greater than the amount of information obtained.

Consider a system whose initial state could result, for instance, from any of the  $W_0$  equally probable complexions and hence *a priori* probability  $p_0 = 1/W_0$  and initial entropy  $S_0 = k \log W_0$ ,  $k$  being Boltzmann's constant. As the system degrades in the course of a natural change, its final state can result from any of the  $W_1 (> W_0)$ , say, equally probable com-

plexions with probability  $p_1 = 1/W_1$ , and its entropy becomes  $S_1 = k \log W_1$ . The change in entropy is

$$S_0 - S_1 = k \log_e (W_0/W_1) = k \log_e (p_1/p_0).$$

Information theory tells that an observation which involves a change in the probability from  $p_0$  to  $p_1$  brings  $\log_2(p_1/p_0)$  bits of information. We can, however, identify  $k \log_e (p_1/p_0)$  itself with the amount of information  $I$  (by choosing a new unit of information) that could possibly be obtained from the system. Thus

$$S_1 = S_0 - I.$$

Brillouin now restates the second law of thermodynamics in a somewhat more generalized form by saying that "in any transformation of a closed system, the quantity entropy *minus* information must always increase or may at best remain constant" and hence argues that information can only be obtained from a system by letting its entropy increase. Notice that every observation is an irreversible one and hence involves an increase in the entropy in accordance with the above reasoning. Under the best of circumstances, the amount of information obtained is equal to the increase in the entropy so that in general

$$\Delta I \leq \Delta S.$$

Because of the opposite sign of information to entropy we might make use of information to decrease the entropy, but the overall balance still remains in favour of an increase in the entropy. Brillouin has seized upon this relationship to discuss the efficiency of an experimental observation which he defines as the ratio  $\Delta I/\Delta S (< 1)$ .

The concept of entropy and the second law of thermodynamics raised in the past many issues with philosophical implications which are still being debated. Information theory with its wide connections gives us a new opportunity to re-examine these questions afresh. Information theory is thus more than a theoretical tool for the evaluation of communication systems; it has already come to stay as a way of thinking about a very wide class of problems.

---

Literature on information theory is very extensive and widely scattered. We cite some references which will enable the reader to pursue his way through this subject.

1. Shannon, C. E., "A Mathematical Theory of Communication, I & II," *Bell Syst. Tech. Jour.*, 1948, **27**, 379-423, 623-56.
2. Wiener, N., *Extrapolation, Interpolation and Smoothing of Stationary Time-Series*, Wiley & Sons Inc., New York, 1949.
3. *Symposium on Information Theory*, Ministry of Supply, London, 1950.

4. Jackson, W. (edited by), *Symposium on Communication Theory*, Butterworth Scientific Publications, London, 1953.
5. Cherry, C. (edited by), *Information Theory*, Butterworth Scientific Publications, London, 1955.
6. "Proceedings of Speech Communication Conference at M.I.T.," *Jour. Acous. Soc. Amer.*, 1950, 689-806.
7. Cherry, C., *On Human Communication*, Wiley & Sons Inc., New York, 1957.
8. Miller, G. A., *Language and Communication*, McGraw Hill, New York, 1951.
9. Goldman, S., *Information Theory*, Constable, London, 1953.
10. Brillouin, L., *Science and Information Theory*, Academic Press, New York, 1956.
11. C. C. I. R., *Bibliography on Communication Theory*, Union Internationale des Telecommunications, Geneva.

---

### $^{12}\text{C}$ AS REFERENCE NUCLIDE

THERE exist at present three scales of atomic masses or weights: (i) the absolute scale based on the gram, (ii) that defined by taking the mass of one atom of the nuclide,  $^{16}\text{O}$  equal to 16 units (the "Physical scale" of "atomic masses" or "nuclidic masses"), and (iii) that taking the average atomic masses of the isotope mixture of "natural" oxygen as 16 units (the "Chemical scale" of "atomic weights"). Of these, only the last two are in common and extensive use. The chemical scale is indefinite to the extent of the variation in the average atomic mass of oxygen from various natural sources (some 15 parts per million) resulting from variations in the relative proportions of  $^{16}\text{O}$ ,  $^{17}\text{O}$  and  $^{18}\text{O}$ .

Recently, proposals for improving this situation have been made and discussed. The necessity of matching the proper value of the Avogadro number with the mass values employed arises especially often in the domain of nuclear chemistry.

Proposals to unite the scales by adopting the physical scale for chemical atomic weights have been regarded with disfavour by many chemists because of the relatively large change, about 275 parts per million, which would have to be made in all of the quantities whose values depend on the size of the mole. There are many physicochemical data whose precision is greater than that and whose value would therefore have to be changed. On the other hand, the serious consideration which has been given by chemists to the proposal of a new unified scale based on  $^{19}\text{F} = 19$ , which would result in a change of 41 parts per million, indicates that many chemists would be willing to accept a unified scale if the atomic weights would not be changed by more than about this amount. There are relatively few chemical data bearing such high precision.

Fortunately, there is a possible scale defini-

tion which, as the basis of a unified scale, would suit chemists and by which, moreover, physicists would benefit greatly.

Evidently, that definition is to be preferred which allows most nuclidic masses to be expressed with the smallest errors, not only now but also in the foreseeable future. As is shown below, this purpose is fulfilled by taking  $^{12}\text{C}$  as the reference nuclide. The best definition of the atomic mass unit is, accordingly,

Mass of  $^{12}\text{C}$  equals exactly 12 atomic mass units. The unit defined in this way is 318 parts per million larger than the present physical mass unit and 43 parts per million larger than the present chemical one.

In the mass-spectroscopic determination of nuclidic masses, the most important substandard is  $^{12}\text{C}$ . Not only do the doubly, triply, and quadruply charged atomic ions of  $^{12}\text{C}$  occur at integral mass numbers so that they can be paired in doublets with nuclides having mass numbers 6, 4 and 3 respectively, but—much more important—no other element besides carbon can be found which forms molecular ions containing as many atoms of but one kind (up to 10 and more). Therefore, the scale  $^{12}\text{C} = 12$  would allow many more direct doublet comparisons of masses, especially of heavy nuclides, with the reference nuclide than any other scale.  $^{12}\text{-Carbon}$  has the additional advantage that carbon forms many more hydrides than any other element, so that an easy reference line for doublets can be produced at almost every mass number up to  $A \sim 120$ . Many stable nuclides in the mass region  $120 < A < 240$  can also be measured in reference to  $^{12}\text{C}$  by pairing in doublets their doubly charged ions with singly charged ions of  $^{12}\text{C}_n$  or of  $^{12}\text{C}_n\text{H}_m$  fragments. Use can then be made of nuclear disintegration data to obtain accurate masses of many other, especially unstable nuclides.—*Science*, 20th June 1958, 127 (3312), 1431.



## GEOHERMAL POWER

THE concept of the economic development of geothermal energy is relatively new, for natural steam emanating from the earth in the form of geysers and fumeroles has been regarded traditionally as a scientific curiosity, and regions exhibiting such phenomena have been set aside as parks and tourist attractions. But in the last few years, a number of nations in many parts of the world have been re-evaluating their thermal areas as something more than mere spectacular scenery. For, in our modern mechanized society with its great dependence on fossil fuels as energy sources, the doubling and redoubling of power requirements in the post-war years has placed a heavy strain on these patently exhaustible resources. As a result energy sources which are essentially inexhaustible, such as falling water, nuclear fission, and geothermal steam, are receiving increased attention.

The theory supporting contentions that subterranean steam is a virtually inexhaustible resource is based on the conversion of both meteoric water and magmatic water to steam. Meteoric water, or ground water, contacting hot rocks near the surface is commonly held responsible for geyser phenomena and is certainly accountable for the occurrence of large quantities of steam; but it is magmatic water, reckoned at about 10% of the superheated earth's core and released upon cooling and crystallization of magma into igneous rock, that makes up the bulk of the steam reserve. Taking both of these sources into consideration, Italian scientists at Lardarello, Tuscany, where the pioneer project of this type has produced power for many years, have estimated that at the present rate of energy withdrawal from the proven geothermal area, reserves are sufficient for another 11,000 years.

However, despite the success of the Italian development and its expansion following the war, little attention had been paid to geothermal development until very recently, when a major project was begun in New Zealand [*Science*, 126, 440 (September 6, 1957)]. Taking advantage of an extremely favourable set of natural and economic circumstances on the North Island, the New Zealand Government in 1950 launched a widely publicized programme to utilize geothermal steam to produce electric power on a large scale. The apparent success in New Zealand (the schedule calls for initial power deliveries this year) triggered a rash of exploration and development schemes in a

number of other widely scattered locations around the world. In Mexico, Iceland, El Salvador, Chile, Fiji, the British Windward Island of St. Lucia, and at the aforementioned Big Geysers, drilling programmes are in the planning stages or already underway.

The Big Geysers Project undertaken by a concern in Santa Rosa, Calif., is still in the early, speculative stage and the aim is merely to test the energy potential of the property by drilling at many different locations and varying depths. Only after the results are in on this exploration and testing, can plans be forthcoming for the economic utilization of the stream. Nonetheless, close observers exhibit a cautious optimism, pointing out that the eight old shallow wells, together with Magma No. 1, are blowing an estimated 6,000 kilowatts of energy into the air; to duplicate this in a modern power plant would require the burning of 240 barrels of fuel oil or 1,444,000 cubic feet of gas per day. Temperatures at the 500-foot level have been determined at 600°, and if the heat gradient continues to rise in proportion to depth 1,000-1,500-foot bores might be expected to have very high temperatures and yield at least the equivalent of 4,000 kilowatts per well (New Zealand wells have averaged 6,000 kilowatts). So far Big Geysers steam, even for existent shallow bores, has proved to be dry, in contrast to the wet steam found in other areas; wetness constitutes a turbine corrosion hazard. Further, engineering reports on the region state that wells can be drilled as close together as 150' without reducing the production of their neighbours, and that the ultimate potential of the property could easily exceed 30 wells, or 100,000 kilowatts, should a substantial portion of the property prove productive.

If such results can be achieved, geothermal steam can compete very favourably in power production. Geothermal steam shares with all other energy sources generating electric power, the long distance transmission line loss, but it has double advantage over hydrogeneration in not being subject to the vagaries of seasonal stream flow or the conflicting water requirements of irrigation *vs.* power development. Similarly, the sharp increases in fuel prices in the past few years, *plus* the need for boilers, which constitute 30-40% of overall power-plant costs, give geothermal steam a real advantage over standard thermal plants.—(*Science*, May 1958.)

## LETTERS TO THE EDITOR

### A METHOD FOR ESTIMATING THE ULTRASONIC VELOCITY IN SOLIDS

FROM the data obtained regarding the supersonic velocities in organic liquids, Rao<sup>1</sup> has suggested a simple relation

$$v^{1/3} \cdot \frac{M}{d} = R \quad (1)$$

where  $v$  is the velocity of supersonic waves in the liquid of molecular weight  $M$  and density  $d$ .  $R$  is a constant independent of temperature. It was further observed that  $R$  is an additive function of the chemical constituents of the liquids.

In the case of liquid mixtures, this relation can be extended as follows :

$$R_{12} = v_{12}^{1/3} \cdot \frac{M_{12}}{d_{12}} \quad (2)$$

$$R_{12} = R_1 x + (1-x) R_2 \quad (3)$$

$$M_{12} = M_1 x + (1-x) M_2 \quad (4)$$

where  $R_1$  and  $R_2$  are the values of  $R$  in the case of solute and solvent respectively and  $R_{12}$  that of the mixture.  $M_1$  and  $M_2$  are the molecular weights of the solute and solvent, while  $M_{12}$  is that of the solution,  $x$  being the molecular fraction of the solute,  $v_{12}$  is the velocity of supersonic waves in the mixture whose density is  $d_{12}$ . For the two constituents of the mixture, the values of  $R$  will be given by eq. (1).

The author has extended these results to the case in which the solute is a solid. Experimental results on the solutions of different concentrations of benzoic acid in ethyl alcohol, propyl alcohol, butyl alcohol and amyl alcohol are reported in a paper (Lal and Sharma<sup>2</sup>) and detailed results on the solutions of benzoic acid in benzene, xylene and toluene are to be reported elsewhere. It is found that Rao's equation can be extended to solid-liquid solutions and the mixture law as given by eq. (3) also holds good in the case of solid-liquid solutions.

Further, the values of the constant  $R$  for the solute (benzoic acid) have been calculated from above equations for the different concentrations of the solute and in different solvents. It is very interesting to note that these values of  $R$  are nearly the same for the same solute irrespective of the solvent. As we are getting the constant value for the solute (solid) in every case,

we may extend Rao's equation

$$v^{1/3} \cdot \frac{M}{d} = R$$

to the case of solids and calculate the velocity of supersonic waves in the solute. The method is thus useful in estimating the ultrasonic velocity in a pure solid solute existing in a hypothetical liquid state at room temperature. The velocity in the case of benzoic acid comes out to be  $3.92 \times 10^5$  cm./sec. It will be quite interesting to test whether this velocity agrees with the value of the velocity in the solute in the molten and in the solid state.

The author expresses his very grateful thanks to Dr. P. N. Sharma for his guidance and encouragement.

Dept. of Physics,  
Lucknow University,  
Lucknow, May 19, 1958.

K. C. LAL.

1. Rao, M. R., *Curr. Sci.*, 1939, **8**, 510.  
—, *Nature*, 1941, **147**, 268.  
—, *Jour. Chem. Phys.*, 1941, **9**, 682.
2. Lal, K. C. and Sharma, P. N., *Zeitschr. fur Physikalische Chemie.*, 1957, **206**, 231.

### POLARIZATION STUDIES ON CHROMATE-TREATED ZINC

MUCH basic and significant information about the processes associated with corrosion inhibition can be obtained from polarization studies.<sup>1,2</sup> It is shown below that polarization data are helpful in elucidating the fundamental mechanism by which chromate treatment of zinc increases the resistance of this metal to corrosion.

Analytical data have shown that a film approximately 0.00002" thick of basic chromium chromate of general formula  $Cr_2O_3 \cdot nH_2O$  is formed on the metal surface during Cronak process.<sup>3</sup> The hexavalent chromium in this film, which is slightly soluble, is leached into the corrosive medium and protection to the metal surface is believed to be obtained both by the well-known inhibiting action of hexavalent chromium in solution and by the insoluble, presumably, trivalent chromium film left on the metal surface.<sup>4</sup>

Fig. 1 shows polarization curves obtained shortly after immersion of untreated and chro-

mate-treated zinc in 0.001% NaCl solution and of untreated metal in solution containing 0.001% NaCl + 500 p.p.m. of sodium chromate. Fig. 2

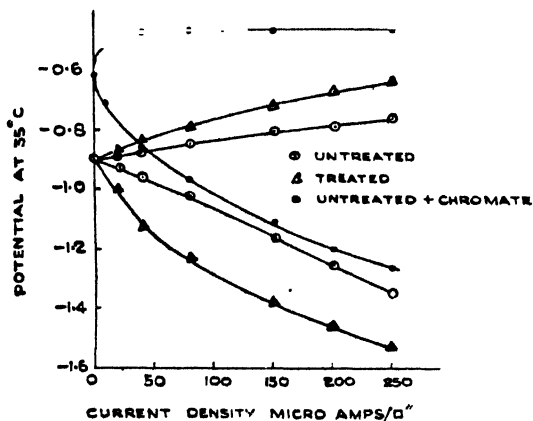

FIG. 1. Polarization curves of untreated and chromate-treated zinc in 0.001% NaCl and untreated zinc in 0.001% NaCl + 500 p.p.m. chromate.

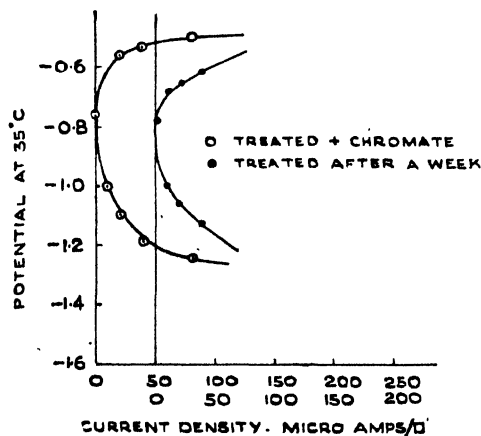

FIG. 2. Polarization curves of chromate-treated zinc in 0.001% NaCl (after a week) and in 0.001% NaCl + 500 p.p.m. of chromate.

shows polarization curves obtained with chromate-treated zinc in (1) 0.001% NaCl + 500 p.p.m. sodium chromate shortly after immersion, and (2) in 0.001% NaCl solution only after immersion for a week. 1" × 1" specimens of the metal were used in the study and the potentials were measured by the Poggendorf method, using a Beckman pH meter as null point indicator.

It may be seen from Fig. 2 that (1) the polarization curve of chromate-treated metal after the lapse of a few days, and (2) polarization curve of chromate-treated metal just after immersion in potassium chloride solution containing hexavalent chromium in addition, both show

considerable similarity, lending support to the view presently held regarding the mechanism of inhibition. The formation of the film itself markedly increases both anodic and cathodic polarization (Fig. 1) and the potential of the metal, therefore, remains more or less unchanged, as predicted by Mears.<sup>2</sup> Hexavalent chromium in solution further increases anodic polarization and thus reinforces the protective action of the film itself. As pointed out in an earlier note,<sup>5</sup> increased polarization may mean either changes in the anodic and cathodic areas of the local cell or changes in the specific reaction velocity factors for the anodic and cathodic reactions. It is not unlikely that film formation brings about profound changes in the anodic and cathodic areas and hexavalent chromium in solution affects the velocity factor of the anodic reaction.

Thanks of the authors are due to Dr. K. S. G. Doss, Director, Central Electrochemical Research Institute, for his suggestions and encouragement in carrying out the above study.

Central Electrochemical Res. Institute, Karaikudi, May 8, 1958.

K. S. RAJAGOPALAN.  
K. BALAKRISHNAN.

1. Evans, U. R., *Metallic Corrosion, Passivity and Protection*, Edward Arnold & Co., London, 1946.
2. Mears, R. B. and Brown, H. H., *J. Electrochem. Soc.*, 1950, **97**, 75.
3. Anderson, E. A., *Proc. Amer. Electroplater's Soc.*, 1943, 6.
4. Ostrander, C. W., *Plating*, 1951, **38**, 1033.
5. Rajagopalan, K. S. and Doss, K. S. G., *Naturwissenschaften*, 1957, **44**, 631.

#### CHEMICAL INVESTIGATION OF CORIANDRUM SATIVUM

THE plant *Coriandrum sativum* (N.O. Umbelliferræ) is widely distributed throughout India and grows widely also in Palestine, Syria, Mesopotamia and Greece. Both in the Ayurvedic as well as in Yunani system of medicine, it is recommended in bronchitis, biliousness, syphilis, dyspepsia.<sup>1</sup> The essential oil of the fruits of this plant has been worked out by a number of workers and various constituents have been identified.<sup>2</sup> The main constituent is coriandrol or linalool.<sup>3</sup> Apart from the essential oil, which is used as a carminative, no other systematic work has been carried out.

In the present work, the dried and powdered fruits of this plant have been extracted with ethyl alcohol (95%) by percolation at room temperature. This alcohol extract after concentration has been re-extracted successively with

light petroleum (40-60°), ether, benzene, chloroform, and ethyl acetate.

From the light petroleum extract, a new triterpene derivative which has been named 'coriandrinol', m.p. 302-04° (vacuum) and a mixture of sugars (glucose, fructose and sucrose) have been isolated. The extract on chromatography over alumina has furnished also a sterol, m.p. 143-50° (acetyl, m.p. 126-30°, benzoyl, m.p. 133-37°) probably  $\beta$ -sitosterol or stigmasterol and a yellow oil, b.p. 312-15°. The benzene extract did not give any definite product other than coriandrinol.

The ether and chloroform extracts have also furnished phenolic as well as acidic products, working up of which is in progress.

Institute of Science, (Miss) D. D. VAGHANI,  
Bombay, May 23, 1958. \* V. M. THAKOR.

\* Present Address: Chemistry Department, Gujarat College, Ahmedabad.

1. Kirtikar and Basu, **2**, p. 1225.
2. Walbaum, H. and Muller, W., *J. Chem. Soc.*, 1910, **98**, 184.
3. (i) Semmler, F. W., *Ber.*, 1891, **24**, 201.  
(ii) Haensel, H., *J. Chem. Soc.*, 1909, **96**, 111.

### SOLUBILITY OF PHOSPHORUS OXYCHLORIDE-ALUMINIUM CHLORIDE COMPLEX

In the course of our investigations on the physico-chemical properties of complexes formed by phosphorus oxychloride with metallic chlorides, it became necessary to determine the solubility of the complexes prepared under a variety of conditions in non-aqueous solvents such as nitrobenzene and acetonitrile. Such a determination by ordinary procedure presents certain experimental difficulties. Both the reactants and the resultant product are extremely hygroscopic. The solvent such as nitrobenzene and water are practically immiscible; however, nitrobenzene has great avidity for moisture which it readily absorbs from atmosphere.<sup>1</sup> The presence or entry of moisture in any form at any stage of the experimental procedure vitiates the result. Therefore, all the operations have to be carried out in moisture-free atmosphere in a dry-box. The following method using the apparatus described below was developed to determine the solubility of the complex prepared from anhydrous aluminium chloride and phosphorus oxychloride. The complex was prepared by mixing a definite quantity of anhydrous aluminium chloride and excess of phosphorus oxychloride. The mixture was warmed up to 95° C. taking care to protect the reactants

in the flask from atmospheric moisture using appropriate guard tubes containing phosphorus pentoxide. After cooling the resulting homogeneous solution to room temperature, the excess of phosphorus oxychloride was removed by evaporation under vacuum. The residue left behind was a colourless free-flowing powder. On analysis, the compound was found to correspond to a complex with the composition  $AlCl_3 \cdot 2 POCl_3$ . The samples of this compound could be stored in ampoules sealed under dry conditions.

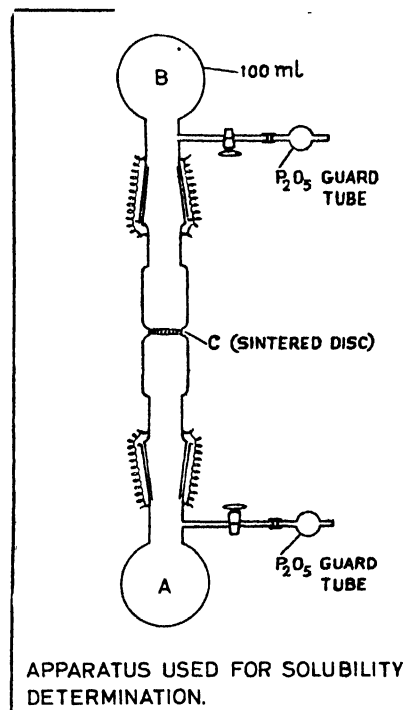

FIG. 1

A definite quantity (about 2.5 g.) of the complex was introduced into the flask A (as shown in Fig. 1) and a known volume (25 ml.) of pure and dry nitrobenzene<sup>2</sup> was added. The apparatus was assembled and all the leads from the stopcocks were protected from moisture by phosphorus pentoxide tubes. The flask was kept in a thermostat at the desired temperature for 24 hr. and the flask frequently shaken to obtain a saturated solution. At the end of 24 hr. the apparatus was removed from the thermostat and inverted to filter the saturated solution through the sintered disc C and to remove the excess of the solid. Since the time required to filter through the disc was only of the order of a couple of minutes, it was found unnecessary to filter the solution in the thermostat

using a more elaborate piece of apparatus. The results were found to be reproducible within an accuracy of 1%. An aliquot portion of the saturated solution was weighed and shaken with distilled-water (50 ml.). The complex hydrolysed forming phosphoric acid and hydrochloric acid along with aluminium chloride. These remained in the aqueous layer. The nitrobenzene layer was separated and repeatedly washed with fresh quantities of distilled-water till the washings were free from acid. The washings and the original extract were mixed and made up to a volume (250 ml.). The solution was analysed for aluminium and phosphorus following the standard methods. Aluminium was estimated as 8-hydroxy quinoline complex volumetrically.<sup>3</sup> Phosphorus was determined by ammonium phosphomolybdate method.<sup>4</sup> From the analytical data the amount of the complex present in the saturated solution of nitrobenzene was computed and the solubilities were calculated. It was found that the solubility of the complex increased with increase in temperature as indicated by the results presented in Table I.

TABLE I

Temperature ° C.	Solubility*
25°	5.910
30°	7.250
40°	8.634

\* Solubility is expressed as the number of grams present in 100 g. of saturated solution in nitrobenzene.

The authors wish to express their grateful thanks to Prof. K. R. Krishnaswami for his keen interest in the work.

Dept. of General Chemistry,  
Indian Institute of Science,  
Bangalore, May 27, 1958.

K. N. VENKATARAMAN.  
A. R. VASUDEVAMURTHY.

1. Roberts, H. M. and Bury, C. R., *J. Chem. Soc.*, 1923, 2037.
2. McAlpine, K. B. and Smyth, C. P., *J. Chem. Phys.*, 1935, 3, 55.
3. Treadwell, F. P. and Hall, W. T., *Analytical Chemistry* (John Wiley, New York), 1951, 151, 260.
4. —, *Ibid.*, 516.

### SOLVOLYSIS OF 1-PHENYL-*n*-PROPYL CHLORIDE

It has been found that 1-phenyl-*n*-propyl chloride undergoes solvolysis in aqueous acetone and aqueous ethanol at rates which are about 25-36% of the corresponding rates for 1-phenylethyl chloride (Table I). The temperature is 50° C. throughout,

TABLE I

Solvent*	$(10^5 k_1 \text{ (sec.}^{-1}\text{)})$	
	CHPhEtCl	CHPhMeCl
80% aq. ethanol	.. 6.60	16.0†
70% do.	.. 18.6	56.0†
60% do.	.. 45.1	169.0
80% aq. acetone	.. 0.310	1.25‡
60% do.	.. 7.80	25.4‡

\* "X%" aqueous ethanol or acetone signifies solvent made up of X volumes of the organic solvent and (100-X) volumes of water.

† Values from Fainberg, A. H. and Winstein, S., *J. Amer. Chem. Soc.*, 1957, 79, 1597.

‡ Calculated from data of Hughes, E. D., *et al.*, *J. Chem. Soc.*, 1937, 1201, using  $E_A$  values given by Grunwald, E. and Winstein, S., *J. Amer. Chem. Soc.*, 1948, 70, 846.

The reverse order for the rates of solvolysis would be expected on the basis of the relative inductive effects of the methyl and ethyl groups. The inversion of the order is presumably due to the dominating influence of the hyperconjugative effect. One point which requires explanation is the large magnitude of the hyperconjugative effect, which is surprising, because the alkyl group is directly attached to the seat of substitution, and not through a highly polarisable system such as a system of conjugated double bonds. In explanation, it is suggested that the phenyl group contributes to the stabilisation of the transition state by allowing a fuller use of the hyperconjugative resonance energy.

Applied Chem. Div.,  
Trivandrum,  
May 8, 1958.

G. GOPINATHAN NAIR.  
R. ANANTARAMAN.

### OBSERVATIONS ON THE ROLE OF METHIONINE IN EXPERIMENTAL MALARIA (*P. GALLINACEUM* IN CHICK MALARIA)

FOLLOWING the observations of Moulder and Evans,<sup>1</sup> that cell-free extract of *P. gallinaceum* contained certain proteases which hydrolyses the globin and on the utilisation of a considerable part of the amino acids obtained by hydrolysis for the synthesis of parasitic proteins and that of McKee and Geiman<sup>2</sup> on the requirement of methionine for the satisfactory *in vitro* growth of *P. knowlesi*, systematic study of the amino acid changes in the blood of chicks infected with *P. gallinaceum* has been undertaken in this laboratory.<sup>3</sup>

The follow-up by the chromatographic techniques of the amino acid make-up of the whole blood, plasma and erythrocytes of normal and parasitised animals has revealed a decrease of combined methionine in the whole blood during incubation and an increase at the height of parasitaemia. Its distribution amongst the constituents of the blood shows that in plasma there is a steady decrease while in the erythrocytes a continuous increase from the time of infection. Free methionine, on the other hand, is seen to increase in the whole blood throughout the course of infection, plasma exhibiting a slight initial increase followed by a decrease while in erythrocytes the inverse relationship is observed<sup>4</sup> (Table I).

Recent *in vitro* studies of *P. knowlesi* by Fulton and Grant<sup>5</sup> using labelled S<sup>35</sup> methionine shows that 80% of methionine in the parasite protein is obtained from that in the red cell globin. This explains the marked increase of methionine in the parasitised erythrocytes of chicks.

Studies on the supplementation of methionine to infected birds showed an earlier onset of parasitaemia and an increased severity of infection compared with the controls (Table II).

The findings of Cohen *et al.*<sup>6</sup> that dietary methionine accelerates the turnover of haemoglobin probably explains the early onset of parasitaemia and increased severity of infection in methionine supplementation studies noticed in our experiment.

Administration of ethionine, a well-known antimetabolite of methionine at a dose level of 10 mg/100 g. body weight to infected chicks prolonged the prepatent period and showed a decreased severity of infection. The findings in individual birds in one set of experiment is shown in Table II.

Taylor<sup>7</sup> has found a 50% reduction in parasitaemia in mice infected with *P. berthii* when treated intraperitoneally with ethionine.

Studies in rats made by Chung Wa and J. L. Bollmann<sup>8</sup> show that ethionine impairs the utilisation of methionine by the body and causes

TABLE I

Free and combined methionine in the whole blood, plasma, and erythrocytes during the course of malarial infection (*P. gallinaceum* in chicks)

Specimen	Combined*			Free amino acid†		
	Normal	Incubation	Parasitised	Normal	Incubation	Parasitised
Whole blood	1.0	0.6	1.3	2.7	3.4	5.5
Plasma	0.5	0.3	0.1	3.12	3.44	3.33
Erythrocytes	0.3	0.7	1.4	2.73	1.30	2.10
Liver	0.9	0.7	0.3	3.30	1.30	3.20

\* Results expressed as percentage of nitrogen.

† Results expressed in micrograms per 147 microlitres of each of the extract made up to the same volume in each case.

TABLE II

Effect of supplementation of methionine and ethionine on experimental Avian malaria (*P. gallinaceum* in chicks)

	No. of birds	Dose and Route	Parasitaemia on the day of infection								Remarks
			5th	6th	8th	9th	10th	11th	12th	14th	
1 Untreated infected chicks	3	..	..	0.5	14	..	22	D	..	..	..
			..	0.4	10	..	18	D	..	..	
			..	1.0	20	D	..	..	..	..	
2 Infected chicks treated with methionine	3	70 mgm. per 100 gm. body wt. I.M.	0.2	2	..	..	12	..	D	..	Earlier appearance of parasites observed
			16	50	..	..	D	..	..	..	
			0.6	8	..	..	9	D	..	..	
3 Infected chicks treated with ethionine	3	10 mgm. per 100 gm. body wt. I.M.	..	..	..	5	..	8	D	..	Has suppressive effect
			..	..	0.2	8	..	12	..	D	
			..	..	..	0.1	..	10.3	D	..	

D = Death.

a greater excretion of the latter in the urine. This antagonism of an essential metabolite to the parasite may also explain the suppressive effect of ethionine noticed in *P. gallinaceum* infection of chicks and of *P. berghii* of rats.

The detailed report will be published elsewhere.

Our thanks are due to Dr. K. P. Menon for his helpful suggestions during the investigation.

Pharmacology Lab., R. RAMA RAO.  
Indian Inst. of Science, K. NAGARAJAN.  
Bangalore-3. A. S. RAMASWAMY.  
May 15, 1958. M. SIRSI.

1. Moulder and Evans. *J Biol Chem.*, 1946, **164**, 145-47.
2. Mckee and Geiman, *Fed. Proc.*, 1948, **7**, 172
3. Rama Rao, *Thesis*, 1955, Bombay University.
4. Rama Rao and Sirsi, *J. Ind. Inst. Sci.* (Under Publication).
5. Fulton and Grant, *Biochem. J.*, 1956, **63**, 274-82.
6. Cohen *et al.*, *J. Biol. Chem.*, 1956, **222**, 85-89.
7. Taylor, A. E. R., *Trans. Roy. Soc. Trop. Med and Hyg.*, 1956, **50**, 418.
8. Chung Wu and Bollmann, *J. I. J. Biol Chem.*, 1954, **210**, 673-80.

### POTENTIOMETRIC DETERMINATION OF THERMODYNAMIC FUNCTIONS OF DISSOCIATION OF GALLIC ACID

In the previous communication, the authors reported the determination at 298 Å of the dissociation constant ( $K$ ) of gallic acid [ $C_6H_2(OH)_3COOH \rightleftharpoons C_6H_2(OH)_3COO + H^+$ ]<sup>2,3</sup> which is used as an analytical reagent for  $Th^{4+}$ ,  $Cu^{+}$ ,  $Al^{+++}$ , etc.,<sup>4</sup> and which contributes in part, to the colour and acidity of sugarcane juices.<sup>5</sup> These studies have now been extended to the determination of  $K$  at different temperatures in the range 300-60 Å, and of the thermodynamic quantities like change in free energy, entropy, etc., on which no data exist in the literature.

Gallic acid of B.D.H. quality was recrystallised several times in distilled-water till the final product gave constant melting point (252°C.) carbonate-free sodium hydroxide was used. A known volume of gallic acid solution of desired concentration was titrated potentiometrically against standard NaOH solution using glass and calomel electrodes. The titration was carried out in an inert atmosphere. The variation of the temperature of the reaction vessel was  $\pm 0.1^\circ C$ .

A typical set of data on the values of  $K$  obtained at different temperatures is given in Table I; column 3 gives the values of thermo-

dynamic dissociation constant  $K$  calculated from the equation

$$\log K = \log K - 2A \times \sqrt{\mu} \quad (1)$$

which follows from the well-known Debye-Huckel limiting formula. The results in Table I

TABLE I

Determination of dissociation constant of gallic acid at different temperatures

Temp. (Å)	Classical Dissociation Constant ( $K$ ) $\times 10^5$	Thermodynamic Dissociation Constant ( $K'$ ) $\times 10^5$
303	3.84	3.396
313	3.76	3.196
323	3.61	3.113
333	3.44	2.917
343	2.69	2.278
353	2.23	1.812

indicate that  $K$  decreases with temperature (see Fig. 1); and the corresponding variation

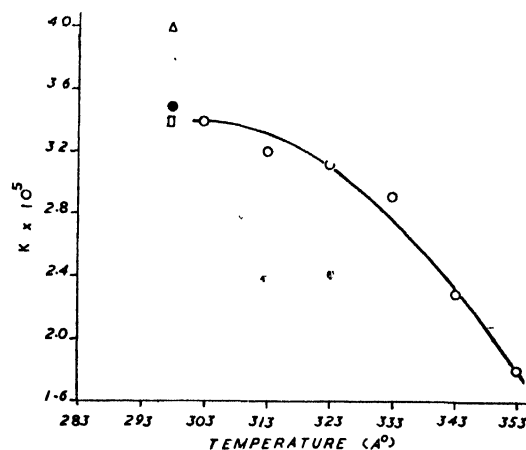

FIG. 1. Variation of the thermodynamic dissociation constant,  $K'$  with temperature.

●—Due to Ramaiah and Gupta (Ref. 1); ×—Ostwald (Ref. 2);

□—Magnaini (Ref. 3); Δ—Tomicek (Ref. 6).

could be expressed by the following equation:

$$-\ln K = A/T + B + CT \quad (2)$$

where  $A$ ,  $B$  and  $C$  are constants with the following values:

$$A = 272.08;$$

$$B = 4.81;$$

$$C = 1.49 \times 10^{-2}.$$

From equation (2) are obtained the values of the change of free energy ( $\Delta F$ ), heat content ( $\Delta H$ ), entropy ( $\Delta S$ ) and heat capacity ( $\Delta C_p$ ) of the dissociation of gallic acid; these are given in Table II.

TABLE II  
Thermodynamic quantities of dissociation of gallic acid

Temp. (Å)	$\Delta F$ I.J. Mole <sup>-1</sup>	$\Delta H$ I.J. Mole <sup>-1</sup>	$\Delta S$ I.J. Mole <sup>-1</sup>	$\Delta Cp$ I.J. Mole <sup>-1</sup>
303	59237	-20896	-264.5	-172.5
313	61887	-22675	-270.2	-178.2
323	64635	-24487	-275.9	-183.9
333	67419	-26353	-281.6	-189.6
343	70250	-28277	-287.3	-195.3
353	73164	-30235	-293.0	-201.0

The details will be published elsewhere.

Authors' thanks are due to Prof. S. N. Gundu Rao, Director, National Sugar Institute, for his kind interest in the work; to the Ministry of Education, Government of India, for a fellowship to one of us (R. K. C.), and to the U.P. Scientific Research Committee for a contingency grant.

Dept. of Physical Chem., •N. A. RAMAIAH.  
National Sugar Institute, S. L. GUPTA.  
Kanpur, May 6, 1958. R. K. CHATURVEDI.

1. Ramaiah, N. A. and Gupta, S. L., *Jour. Indian Chem. Soc.*, 1956, **33** (7), 535-36.
2. Ostwald, *Zeit. f. Physik. Chemie*, 1889, **3**, 369.
3. Magnaini, *Gaz. Chimica Italiana*, 1891, **21**, 215.
4. Charlot, *Anal. Chem. Acta*, 1948, **1**, 218; Datta, *J. Indian Chem. Soc.*, 1955, **32**, 687.
5. Zerban and Browne, *Sugar Analysis*, John Wiley, N.Y., 1941.
6. Tomicek, *Chemical Indicators*, Butterworth's Sci. Publ., 1951.

### NITROGEN CONTENT AND YIELD OF SOME SUGARCANE VARIETIES

ON the basis of the thorough investigation of the chemistry of sugar-producing plants, O. W. Willcox<sup>6</sup> formulated in 1928 the 'Inverse Yield Nitrogen Law in Agriculture', according to which, "Of two or more kinds of plants grown concurrently under the same normal conditions, the one with the smallest per cent. of nitrogen will yield the largest quantity of dry vegetable substance". Since then much evidence has accumulated on the yield potential of sugarcane varieties as an inverse function of their nitrogen content. Fort and Holmes<sup>4</sup> of Louisiana, Carreras of Peru<sup>2</sup> and Beauchamp of Cuba<sup>1</sup> have produced evidence in support of this theory. Although Dutt and Aiyar<sup>3</sup> of Coimbatore, and Vallance<sup>5</sup> of Queensland have produced data which deviate from this rela-

tionship, it may be pointed out here that many of the varieties on which these latter workers worked, behaved in consonance with the Willcox's postulate.

We noted the inverse relationship of the nitrogen content of some varieties of sugarcane with their yielding ability at the Indian Institute of Sugarcane Research, Lucknow, in 1957-58. Varietal trials have been under progress in the Agronomy Section at this Institute since 1954-55, wherein yield data of five varieties (Co. 453, Co. 997, Co. 617, Co. 957 and Co. 313) for four years, e.g., 1954-55, 1955-56, 1956-57 and 1957-58 are available. On examining these data critically for three years, it was observed that the relative yield of these varieties excepting the variation that is usual in field trials, has been more or less on the same pattern. To test whether their yield behaviour could be explained on inverse yield-nitrogen relationship, cane stick samples were taken from these varieties on the day the varietal trial of 1957-58 was harvested. Their nitrogen content was determined and the result expressed on oven-dry basis. The nitrogen content (1957-58) and the average yield of cane stick in maunds per acre of these varieties for four years have been given in Table I.

TABLE I

Percentage nitrogen (1957-58) and yield of five varieties of sugarcane for four years

Varieties	Mean percentage Nitrogen in cane stick 1957-58	Average yield of cane in maunds per acre for four years
Co. 453	.. 0.34 ± 0.00	752.4 ± 108.60
Co. 997	.. 0.35 ± 0.01	604.9 ± 130.67
Co. 617	.. 0.39 ± 0.01	558.3 ± 128.85
Co. 957	.. 0.41 ± 0.01	531.0 ± 114.82
Co. 313	.. 0.45 ± 0.00	379.4 ± 23.60

From the table it is evident that the yield behaviour of these varieties is in conformity with the inverse yield-nitrogen relationship, indicating that under the soil and environmental conditions of the growth of these varieties, their yield potential was determined, to a great extent, by their nitrogen content.

As this finding has some implication in the selection of varieties at early stages of selection, we are planning to investigate this relationship for a large number of varieties in future.



Our thanks are due to Dr. J. T. Rao, Agronomist, for kindly providing us yield data of these varieties.'

Soil Chemistry Section,  
Indian Institute of  
Sugarcane Research,  
Lucknow, June 9, 1958.

AMBIKA SINGH.  
BALJIT SINGH.

1. Beauchamp, C. E., *Mem. Conf. Ann. Tec. Azuc. Cuba*, 1941, **15**, 39-46; Abst. in *Facts ab. Sug.*, 1941, **37**, 8.
2. Carreras, J., *Agronomia*. [Lima, **3**, 15 cf. *J. Amer. Soc. Agron.* 1939, **31** (6), pp. 568-571.]
3. Dutt, N. L. and Aiyar, K. V. Gopal, *Proc. Indian Sci. Congr. 33rd Sessio.*, 1946, Bangalore.
4. Folt, C. A. and Holmes, R. L., *Sug. Bull.*, 1938, **16** (6), 2-4. Abst. in *Facts ab. Sug.*, 1938, **33** (2), 36.
5. Vallance, *Ann. Rep. Bur. Sug. Exp. Sta. Queensland*, 1956, **56**, 29.
6. Willcox, O. W., *Facts ab. Sug.*, 1928, **7**, 158.

#### HITHERTO UNRECORDED OCCURRENCE OF *DATURA INNOXIA* MILL. IN THE UPPER GANGETIC PLAIN AND THE RAJASTHAN DESERT

In the Upper Gangetic Plain, only three species of *Datura* are known to occur, viz., *D. suaveolens* H. and B. (Raizada<sup>1</sup>), *D. metel* Linn. and *D. stramonium* Linn. (Duthie<sup>2</sup>). The last two species are the only ones recorded from the Rajasthan desert.

*D. innoxia* Mill., syn. *D. metel*, auctt. (non-Linn.), can be easily distinguished from other species of *Datura* by the presence of greyish tomentum on the whole plant; 10-toothed corolla, and long slender spines on the capsule that dehisces irregularly.

As pointed out by Santapau,<sup>3</sup> this species has been wrongly mentioned as *D. metel* in most of the Indian Floras. Duthie, describing this species under the name of *D. metel* Linn. in the flora of the Upper Gangetic Plain and of the adjacent Siwalik and Sub-Himalayan tracts wrote,

"I have seen no record of this species within the limits of this flora, though probably occurring near habitations in Sub-Himalayan tracts." Similarly there is no record of this species in the floristic literature of the Rajasthan desert.

The present author, however, found this species quite commonly in Lucknow Dist. and elsewhere in the Upper Gangetic Plain, growing scattered near habitations in waste lands and near water. In the Rajasthan desert it was noticed to occur on stabilized sand dunes. At Sambhar Lake, this species was found on the banks of small ponds in which the brine is collected to crystallize out the salt. In these halophytic specimens, the roots were rather swollen.

The absence of any record of this species in the earlier floristic literature of these regions seems to indicate that most probably this species has been introduced in these regions rather recently.

I am highly thankful to Dr. R. N. Lakhanpal for going through the manuscript.

Birbal Sahni Institute of  
Palaeobotany,  
53, University Road,  
Lucknow, June 6, 1958.

1. Raizada, M. B., *J. Indian bot. Soc.*, 1936, **15**, 149-67.
2. Duthie, J. F., *Flora of the Upper Gangetic Plain and of the Adjacent Siwalik and Sub-Himalayan Tracts*, Calcutta, 1911, **2**, 131.
3. Santapau, H., *J. Bombay Nat. Hist. Soc.*, 1948, **47**, 659.

#### RECORD OF A NEW PHOLAD, *PENITELLA* SP., FROM SHINGLE ISLAND (IN THE GULF OF MANNAR) WITH A NOTE ON ITS DISTRIBUTION

PREVIOUS workers<sup>1-3</sup> have recorded, so far, four pholads, *Jouannetia*, *Pholas*, *Pholadidea* and *Martesia*, from Indian waters. During a collection trip, in September 1956, two specimens of *Penitella* sp. *Valenciennes*, buried in coral rock, were recovered from Shingle Island in the Gulf of Mannar.

The shell is oval in outline measuring 30 mm. in length and 17 mm. in breadth. A distinct umbonal-ventral sulcus dividing the shell into two regions is present. The callum is well developed. The protoplax is absent and the mesoplax is transverse in one piece. The meta-plax and hypoplax are characteristically absent.

Turner<sup>4</sup> states that this pholad, so far as now known, is restricted in its distribution to the Eastern and Northern Pacific. The present record of this genus tends to show its further distribution in Indian waters.

Our thanks are due to Dr. Ruth D. Turner, Museum of Comparative Zoology, Harvard University, for identifying the pholad.

Dept. of Zoology, P. N. GANAPATI.  
Andhra University, R. NAGABHUSHANAM.  
Waltair, January 27, 1958.

1. Satyamurti, S. T., *Bull. Madras Govt. Mus.*, 1956, **1**, 2.
2. Beeson, C. F. C., *Indian Forester*, 1936, **62**, 1.
3. Erlanson, E. W., *Curr. Sci.*, 1936, **4**, 726.
4. Ganapati, P. N. and Nagabhushanam, R., *Ibid.*, 1953, **22**, 345.
5. Daniel, A., and Srinivasan, V. V., *Ibid.*, 1956, **25**, 59.
6. Turner, Ruth D., *Museum Comp. Zool. Johnsonia*, 1954, **3** (33 and 34), 1-160.

**MATING TYPES IN STYLONYCHIA  
PUSTULATA**

FOLLOWING Sonneborn's discovery of mating types in *Paramecium aurelia*, in 1937,<sup>1</sup> mating types were found in other species of *Paramecium* (Jennings, 1939<sup>2</sup>; Gilman, 1939<sup>3</sup>; and Giese, 1939<sup>4</sup>) and in *Euplotes patella* (Kimball, 1939<sup>5</sup>). More recently mating types have been reported in *Stylonychia putrina* (Downs, 1952<sup>6</sup>), *Tetrahymena pyriformis* (Elliot and Gruchy, 1952<sup>7</sup>; Nanny and Caughey, 1953<sup>8</sup>) and *Oxytricha bifaria* (Siegel, 1956<sup>9</sup>). In addition to these species Sonneborn (1941<sup>10</sup>) interprets the observations of Maupas as indicating that mating types actually occur in *Stylonychia pustulata*, *Leucophrys patula*, *Onychodromus grandis* and *Loxophyllum fasciola*. But no attempt seems to have been made to study mating types in these four species. This article is designed to outline the general features of mating types in *Stylonychia pustulata*.

Detailed investigations in *Paramecium aurelia* (Sonneborn, 1947<sup>11</sup>) revealed only two mating types in a variety while in *Paramecium bursaria* (Jennings, 1939<sup>2</sup>), *Euplotes patella* (Kimball, 1939<sup>5</sup>), *Tetrahymena pyriformis* (Nanny and Caughey, 1953<sup>8</sup>), and *Oxytricha bifaria* (Siegel, 1956<sup>9</sup>), revealed more than two mating types in each variety. Examination of a number of stock cultures of *Stylonychia pustulata* has revealed the occurrence of three varieties and eight mating types.\* These have been designated in Roman numerals. The breeding relations are shown in Table I.

TABLE I  
System of breeding relations in  
*Stylonychia pustulata*

Variety	Mating type	1		2				3	
		I	II	III	IV	V	VI	VII	VIII
1	I	-	+	-	-	-	-	-	-
	II	+	-	-	-	-	-	-	-
	III	-	-	-	+	+	+	-	-
2	IV	-	-	+	-	+	+	-	-
	V	-	-	+	+	-	+	-	-
	VI	-	-	+	+	+	-	-	-
3	VII	-	-	-	-	-	-	-	+
	VIII	-	-	-	-	-	-	+	-

\*The material was collected from canals and ponds of several localities, including two neigh-

bouring towns, Vizianagram and Anakapalli. The mass cultures were maintained in wheat grain infusion and the clones in beef extract medium, described by Baitsell (1912<sup>12</sup>). No difficulty was experienced in maintaining the cultures. For ascertaining the mating types the clones were mixed in all possible combinations and the complimentary mating types made out from the mating reaction. Each mating type is defined by its unique property to mate with the opposite mating type.

Pairs appeared in the suitable combinations of the clones in 3-4 hr. after mixing. The near exhaustion of food after a well-fed condition appeared to be an essential prerequisite for pairing as pointed out by Kimball (1939<sup>5</sup>) for *Euplotes patella* and for this reason a drop of culture medium was added after the clones were mixed. When the organisms were numerous the food is immediately exhausted and pairs soon appeared. When different mating types were mixed, no agglutinative reaction was observed and the mating reaction was similar to *Stylonychia mytilus* described by Grell (1951<sup>13</sup>).

Encystment was observed in the stocks of variety 1 and 2 and preliminary investigations revealed the occurrence of autogamy in variety 1. Selfing was observed in a few instances in the mating type IV and detailed investigations on these problems will form the subject-matter of another communication.

The author wishes to express his thanks to Prof. P. N. Ganapati for the constant help and criticisms received throughout the course of this work.

Dept. of Zoology, M. V. NARASIMHA RAO.  
Andhra University,  
Waltair, March 14, 1958.

- Sonneborn, T. M., *Proc. Nat. Acad. Sci. Wash.*, 1937, **23**, 378.
- Jennings, H. S., *Amer. Nat.*, 1939, **73**, 414.
- Gilman, L. C., *Ibid.*, 1939, **73**, 445.
- Giese, A. C., *Ibid.*, 1939, **73**, 432.
- Kimball, R. F., *Ibid.*, 1939, **73**, 451.
- Downs, L. E., *Proc. Soc. Exp. Biol. Med. N.Y.*, 1952, **81**, 605.
- Elliot, A. M. and Gruchy, D. F., *Biol. Bull. Wood's Hole*, 1952, **103**, 301.
- Nanny, D. L. and Caughey, P. A., *Proc. Nat. Acad. Sci. Wash.*, 1953, **39**, 1057.
- Siegel, R. W., *Biol. Bull. Wood's Hole*, 1956, **110**, 352.
- Sonneborn, T. M., *Protozoa in Biological Research*, (Clakins and Sommers, ed.), Columbia Univ. Press, N.Y., 1941, **14**, 666.
- , *Advance Genet.*, 1947, **1**, 263.
- Baitsell, G. A., *J. Exp. Zool.*, 1912, **13**, 47.
- Grell, K. G., *Z. Naturf.*, 1951, **6**, 45.

### THE OCCURRENCE OF SCYPHISTOMA LARVAE IN VISAKHAPATNAM HARBOUR

ALTHOUGH some information is available on the occurrence and distribution of Scyphomedusæ in the Indian Seas<sup>2-5,8-12</sup> there is no published account of the development of any of the Indian forms.

While engaged in a study of the Fouling Organisms of the Visakhapatnam Harbour, we suddenly encountered a number of Scyphistomæ on a test-panel, at Station C<sup>6</sup>, which was heavily fouled by the Serpulid worm, *Mercierella enigmatica* Fauvel, during the period June-July 1957. They were found epizoid on the shells of the Serpulids as well as directly attached to the panels.

The Scyphistoma (Fig. 1) has a cup-shaped body terminating distally in an oral disc bordered by a circlet of tentacles surrounding the

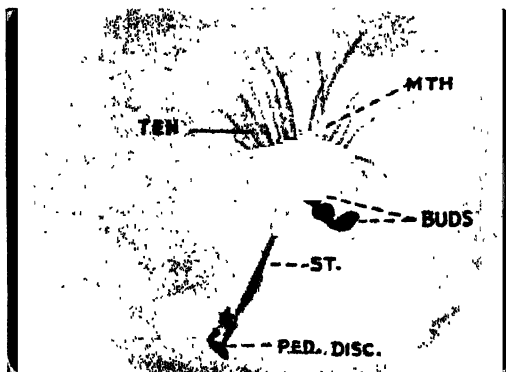

FIG. 1. MTH=Mouth; TEN=Tentacles, ST.=Stalk; PED. DISC.=Pedal Disc.

mouth. The lips of the mouth project a little beyond the bases of the tentacles. The body is drawn out into a stalk which ends in a flattened and well developed pedal disc. The stalks are long and muscular and the pedal discs apparently secrete a substance which makes the animal adhere to the substratum. The number of tentacles varied from 14-30 depending on the stage of development. The entire body surface including the tentacles and the stalk was covered by very long cilia. All the Scyphistomæ were profusely budding. The buds arise from the body-wall at about the junction of the stalk with the body. They first appear as knob-like outgrowths (Fig. 1) which later constrict themselves off from the parent after attaining appreciable sizes, but before any significant development has taken place. The type of budding observed corresponds to

Type I reported by Berrill.<sup>1</sup> As many as four buds might appear at a time in the same Scyphistoma. In some cases the buds may form in chains of two or three (Fig. 1) when the total number may exceed four. The buds after detachment from the parent actively swim for about 48 hours aided by the long body cilia and then attach themselves by the end which is opposite to the base of constriction from the parent. The mouth and tentacles develop at the distal end, after attachment. These forms disappeared as suddenly as they appeared, perhaps due to sudden lowering of salinity, consequent on heavy rains during August. They again made their appearance on the panels suspended during January-February 1958, at the same location.

In December 1957, we obtained a second type of Scyphistomæ attached to barnacle shells and test frames suspended at the local Naval Base. These specimens were smaller than the first type collected from Station C. They also lack the typical stalk characteristic of the previous forms and the type of budding was entirely different. They were exhibiting the fig-type buds, pedal stolons (Fig. 2) and the Hydra-type buds described by Gilchrist<sup>7</sup> for *Aurelia*.



FIG. 2. PED. ST.= Pedal Stolon.

The formation and growth of the pedal stolons was also similar to those described by Gilchrist. The type of budding described for the Station C specimens was conspicuously absent in these forms. We have not obtained ephyrae from either of the two types though they lived for one month in a healthy condition in the laboratory.

While it is essential to procure the ephyrae of the two types of Scyphistomæ described, before their identity could be correctly established, it seems to us, fairly certain that they may belong to different genera. The Scyphistomæ collected from the Naval Base may belong

to *Aurelia* as already mentioned. Of the three species of *Aurelia* recorded from Indian waters, *A. aurita*,<sup>10,12</sup> *A. maldivensis*<sup>2,10</sup> and *A. solida*,<sup>5,8,10-12</sup> the last one has a wide distribution in the Indian Seas. Rao<sup>12</sup> has recorded a single specimen of *A. solida* from the backwaters of Visakhapatnam in the vicinity of the Harbour area. It is likely that our Naval Base forms may belong to this species.

The well developed stalks and pedal discs, the number of tentacles and the simple type of budding of the Scyphistomæ collected from Station C suggest that they may belong to either of the three genera, *Cyanea*, *Cassiopea* and *Chrysaora* (Berrill<sup>1</sup>), all of which have been reported from the Indian Seas. *Acromitus flagellatus* is also another very common Scyphomedusa in the coastal waters of India, the development of which is unknown at present.

Incidentally this is the first report of Scyphistomæ on fouling panels (see "Marine Fouling and Its Prevention" for species of Foulers recorded<sup>13</sup>).

Further details of reproduction and budding are being worked out and will be published elsewhere.

We thank Dr. W. J. Rees of the British Museum of Natural History for commenting on our Station C specimens.

This work has been carried out with the funds provided by the Forest Research Institute, Dehra Dun, obtained from various sources for the execution of the Scheme on "Protection of Timber against the Marine Organisms Attack".

Dept. of Zoology, P. N. GANAPATI.  
Andhra University, M. V. LAKSHMANA RAO.  
Waltair, April 3, 1958.

1. Berrill, N. J., *Biol. Rev. Cambr. Phil. Soc.*, 1949, **24**, 392.
2. Bigelow, H. B., *Bull. Mus. Comp. Zool. Harvard Coll.*, 1904, **39**.
3. Browne, E. T., *Trans. Linn. Soc. Lond.*, 1906, 166.
4. —, *Ibid.*, 1908, 208.
5. —, *Fauna Geogr. Laccadiv. Maldiv. Archipelago*, II, 1906, 960.
6. Ganapati, P. N., Rao, M. V. I. and Naga-bhushanam, R., *Andhra Univ. Ser. 62 Memoirs in Oceanogr.*, II, 1958, 193.
7. Gilchrist, F. G., *Biol. Bull.*, 1937, **72**, 99.
8. Menon, M. G. K., *Bull. Madras Govt. Mus.*, N.S., 1930, **3** (1), 28.
9. —, *Ibid.*, N.S. 1936, **1** (2), 9.
10. Meyer, A. G., *Medusa of the World*, 1910, **3**.
11. Nair, K. K., *Bull. Central Res. Inst., Trivandrum*, 1951, **2** (1), 47.
12. Rao, H. S., *Rec. Indian Mus.*, 1931, **33** (1), 25.
13. By various authors, *Marine Fouling and its Prevention*, U.S. Naval Inst, Annapolis, Maryland, U.S.A., 1952.

## ABNORMAL POLLEN TUBE DEVELOPMENT IN A *NICOTIANA* HYBRID

INSTANCES are on record relating to multiple tube formation in pollen grains and also their forking during elongation (Maheshwari, 1950). Such occurrence has been reported to be frequent in members of the group Amentiferæ, where the extreme condition of ramification of the tube seems to have been met with. In the genus *Nicotiana* itself, Goodspeed is reported to have cited cases where more than one tube from a pollen grain entered the embryo-sac. Dusseau (1944) also reports bifurcate pollen tube in amphidiploid *N. suaveolens* × *N. glutinosa* and *N. glutinosa* × *N. sylvestris* hybrids. To augment the instances already reported and also as the phenomenon occurred in unusually high frequency in the present case, the following note on the abnormal pollen tube development in *N. longiflora* × *N. alata* hybrids is submitted.

The F<sub>1</sub> hybrid is almost sterile with about 20% of stainable pollen grains which failed to germinate on stigma of the self same flower or that of other hybrid flowers or of the parents. With a view to determine the cause for their failure to function, germination tests in agar-sucrose medium were conducted. While the grains were apparently inactive on the stigma, tube formation in the medium was very vigorous and they developed even as early as 4 hr. after dusting. The percentage of germination was found to be well over 90. However, only about 50% of the grains produced normal tubes while the rest were abnormal as indicated in Table I.

TABLE I  
Germination in agar medium

S. No.	Type of abnormality	No. of grains	Reference
1	Normal	.. 47	
2	More than one tube per grain	.. 14	Pl. I
3	Forking of tube near the base	.. 11	Pls. II & III
4	Forking of tube in the middle	.. 8	
5	Forking of tube at the distal end	.. 4	
6	Finger-like protuberance	.. 6	
7	Hyphæ-like ramifications	.. 3	
Total:		Normal—47; Abnormal—46	

The parental pollen were sown under similar conditions and normality was recorded to 100%.

Forking of the tubes take place either near the pollen grain (Plates II and III) or at the distal end. The arms always contain cytoplasmic materials. Meiosis in the hybrid which has

been found to be irregular (*N. longiflora*,  $n = 10$ ; *N. alata*,  $n = 9$  and hybrid  $2n = 19$ ) resulted in heavy tetrad abortion and the pollen fertility is therefore reduced to 20-30%.

Tests on pollinating the hybrid and parental



PLATE I



PLATE II

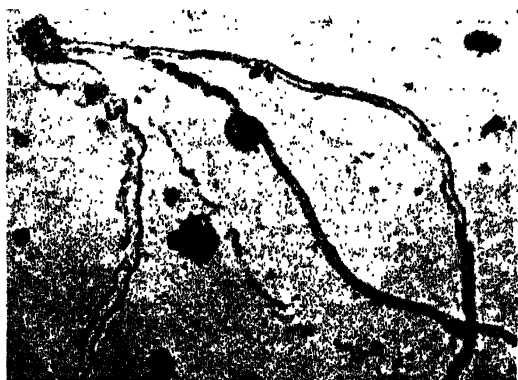

PLATE III

PLATE I. Two well-developed tubes from a single grain.  
PLATES II & III. Tube forking.

stigma with the hybrid pollen and *vice versa* revealed that a few grains germinated on the stigma with or without the help of agar medium and that abnormalities of tube development also occurred on the stigma even in the absence of any medium.

Two facts need to be explained in the above hybrid, namely, (1) the cause for sterility, and (2) the abnormal tube production. Regarding the former, the available good pollen grains in the anther is very little and the possibility of all of them reaching the stigma is remote. Even reaching the stigma their germination is possibly prevented due to hybrid incompatibility as a result of which they remain as they are on the stigma. Even the few grains that were viable produced only short tubes which could not penetrate the style. Further, it may be noted that the grains equally failed to germinate on parental stigma. It would therefore mean that the apparently good grains are mostly non-functional. Added to this, the style and stigma of the  $F_1$  may be incompatible for pollen tube development. How far ovule sterility also exists, needs further investigation and work is under way.

Regarding the production of abnormal tubes, it would appear that abnormalities occur with a higher frequency in agar medium (Table I) but also it is occurring even in the absence of the medium on the stigma. To suppose that agar medium would have acted as a mutagenic stimulant had to be ruled out since pollen of parental species as well as those of others, germinated in the medium, developed normal tubes. It would therefore mean that the abnormal pollen tube growth might be the characteristic of the hybrid pollen and is supported by the evidence cited by Sarana (1934) and Dusseau (1944). Such abnormal tube development may be adding to the sterility of the hybrid.

The authors wish to express their thanks to Dr. N. R. Bhat, Director, Tobacco Research, for the keen interest he has evinced during these investigations and offering valuable suggestions.

Central Tobacco Res. K. V. KRISHNAMURTY.  
Institute, K. APPARAO.  
Rajahmundry, May 5, 1958.

1. Dusseau, A., *Bull. Soc. Bot. Fr.*, 1944, **91**, 50-60. [*P.B.A.* 1948, **16** (1), 390.]
2. Maheshwari, P., *An Introduction to the Embryology of Angiosperms*, McGraw-Hill Book Col., N.Y., 1950.
3. Sarana, M., *Bull. Inst. Tobac. Ind. U.S.S.R.*, 1934, **110**, 191-219. [*P.B.A.*, 1935, **5** (1) 138.]

**STUDIES ON THE DIETARY REQUIREMENTS OF THE HIDE BEETLE (*DERMESTES MACULATUS* DEGEER, *DERMESTIDÆ*: *COLEOPTERA*) WITH PARTICULAR REFERENCE TO AMINO ACIDS AND VITAMINS**

THE hide beetle (*Dermestes maculatus* Deg.) is of international importance as a troublesome pest of dried fish, cheese, ham, hides and hide-products. In literature, *Dermestes vulpinus* Fab. is more often reported than *Dermestes maculatus* Deg. But according to Nuesebeck (1950), the correct specific name is *maculatus*.

Stock cultures of *Dermestes maculatus* (Deg.) were maintained on "Dog biscuits" at a temperature range of 75-80° F. Larvæ were isolated in glass dishes and small vials with appropriate media. Series of twenty-four larvæ were used in each test diet. Observations were made on alternate dates. Records were kept on pupation, emergence, larval time in days, number of instars, pupal period in days, weight of males and females in mg. in relation to different food media. For obtaining the desired levels of moisture in the food media, the oven-drying method was used. The dietary materials included in the experiment were casein hydrolysates (untreated and vitamin-free), amino acids (cystein, glutanic acid, tryptophane, glycine and arginine), fats (linoleic acid and cholesterol), carbohydrate (sucrose and corn starch) and salt (sodium chloride). These food factors were used as supplements to casein diet. Each test diet was replicated twenty-four times. The diets were changed on alternate days. Methods described by Fraenkel and Blewett (1943, 1954) were used to study the growth factors associated with yeast fraction (soluble and insoluble in water) in the casein diet. The "dog biscuit" is a mixture of meat, dried skimmed milk, wheat germ, dried beet, soybean meal, dehydrated cheese, molasses, and vitamin B complex, A and D. The materials were purchased from the Nutrition Biochemical Corporation, Cleveland, Ohio.

**RESULTS**

Studies on the correlation between moisture levels of dietary media and the larval growth of *Dermestes maculatus* were carried out. Four levels of moisture (10%, 30%, 50% and 70%) were considered in the experiment. The "dog biscuit" which was reported as complete food was used as test diet. Twenty-four larvæ were used under each diet test. No larval growth was recorded at the 10% moisture level. Thirty per cent. moisture seems to be better than 50%

or 70% for the larval growth. The higher the moisture content of the food media, the shorter was the duration of the larval period, and the greater was the weight of the female. The number of females surviving under condition of low moisture was greater than the number of males. Conversely, ratio of males to females was greater under condition of higher moisture. It was found that optimum moisture content of the "dog biscuit" food media was around 30%.

The larvæ of *Dermestes maculatus* were able to synthesize necessary sugar from casein in the presence of cholesterol for their growth. Both corn-starch or sucrose as supplements to casein were found to be unsatisfactory without cholesterol. This agrees with the reports of Fraenkel and Blewett (1943).

The amino acids (tryptophane, glycine, glutanic acid) as supplements to casein were as efficient as yeast. A study of B complex vitamins as supplements to vitamin-free casein indicated that thiamine, riboflavin, niacin, pantothenic acid, pyridoxine and choline were essential. Folic acid and biotin accelerated the larval growth and development.

Curiously enough, vitamin-free casein supplemented with sucrose, glutanic acid, glycine, tryptophane, cholesterol, salt and water, supported larval growth of the hide beetle. Probably the micro-organisms present in the intestine were able to synthesize necessary vitamins from the diet.

A diet consisting of casein, cholesterol and water was close to a minimum basic diet. Addition of sucrose, amino acid and salts gave very good larval growth. When yeast was substituted for amino acid in the basic diet, the larval growth was greatly accelerated, but there was practically no difference in the weight of adults. This indicates that both yeast and amino acid furnished similar growth factors. According to Fraenkel and Blewett (1942 and 1943), the yeast contains the vitamins, biotin and choline in addition to thiamine, riboflavin and niacin and other factors of vitamin B complex.

In literature it has not been demonstrated previously that the amino acids, such as tryptophane, glycine and glutanic acid, could be used for the formation of certain growth factors in insects. Further, by increasing the quantity of these three amino acids, the vitamin-free casein diet seems to provide a basic vitamin requirement of the beetle. The specific roles of micro-organisms present in the intestinal tract of the hide beetle which are able to synthesize

necessary vitamins from the basic diet need further investigation.

The writer expresses his gratitude to Dr. William E. Bickley and Dr. George S. Langford, Department of Entomology, University of Maryland, U.S.A., for their personal interest and invaluable guidance during the course of this investigation.

Division of Entomology,  
Bihar Agricultural College,  
Sabour, May 24, 1958.

B. S. LALL.

1. Fraenkel, G. and Blewett, M., *Nature* (London), 1942, **151**, 703.
2. — and —, *Biochem. Jour.*, 1943 *a*, **37**, 686-92.
3. — and —, *Jour. Exper. Biol.*, 1943 *b*, **20**, 28-34.
4. — and Printy, G. E., *Biol. Bull.*, 1954, **106**, 149-57.
5. Nuessbeck, C. F. W., *Jour. Econ. Ent.*, 1950, **43**, 117-138.

### CHROMOCENTERS AND NUCLEOLAR EQUIVALENTS IN THE YEAST NUCLEUS

THE visibility of the nuclear and vacuolar membranes<sup>1-3</sup> in living cells from five-day wort (S.G. 1.020, pH 4.6-4.8) cultures of *Saccharomyces cerevisiae* (NRR1. Y.567) enabled the accurate location of the nucleus as an extra-vacuolar structure. Formed structures are often visible in the dormant living nucleus (Photos 1 and 2). They often lie apposed to

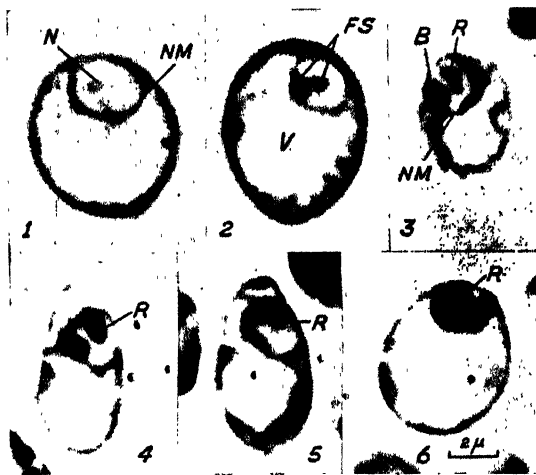

PHOTOS 1 and 2. Living cells (Ordinary Illumination). PHOTO 2. An intranuclear structure is lying in contact with the nuclear membrane.

PHOTOS 3 and 4. Iodine-formaldehyde acetic—Giemsa. PHOTOS 5 and 6. Modified Carnoy—Giemsa.

PHOTOS 3-6. The intranuclear structures could be distinguished into the blue (B) nucleolar equivalents and the red (R) chromocenters.

B., Blue nucleolar equivalents, FS., Intranuclear structures; N, Nucleus; NM, Nuclear membrane; R, Red chromocenter; V., Vacuole.

the nuclear membrane giving it an irregularly thickened appearance (Photo 2). Though Heidenhain's hæmatoxylin yields superposable pictures on those of living nuclei<sup>4-6</sup> separation of the intranuclear organelles into distinct categories would be possible only by differential staining.

Feulgen preparations showed that the intranuclear structures were of two types.<sup>4</sup> Some were stained by leuco basic fuchsin while the others had an affinity for the counterstain, light green. When hydrolysed material was stained with Giemsa, the Feulgen positive areas were purplish-red while the Feulgen negative structures were light pink. An attempt was, therefore, made to discover whether these two types of organelles could be stained differentially with Giemsa in unhydrolysed cells.

Smears of cells with visible nuclei were fixed in iodine-formaldehyde-acetic acid solution<sup>2,4</sup> as well as in Carnoy's fluid as modified by Lindegren *et al.*<sup>7</sup> The slides freed of traces of the fixatives were rinsed well in a 1:1 mixture of tap- and distilled-water and transferred to a staining bath prepared by diluting 4 ml. of Giemsa (Gurr) with 20 ml. each of tap- and distilled-water.

When examined after an hour the cells appeared uniformly blue. The vacuole was unstained and in a few of the cells the chromatin was stained red. When the smears were carefully differentiated in 20% alcohol and examined as water mounts the cytoplasm and the nuclear membrane were blue. The intranuclear structures could be clearly separated into (1) the red-stained chromocenters (R. Photos 3-6), and (2) the blue-stained (B. Photos 3-6) nucleolar equivalents. The staining was similar whether the cells were fixed in iodine-formaldehyde-acetic (Photos 3 and 4) or in the modified Carnoy (Photos 5 and 6). The red chromatinic (Feulgen-positive) areas were less resistant to destaining than the blue-stained (Feulgen-negative) regions. This feature was more pronounced in cells fixed in Carnoy.

The intranuclear blue-stained areas show a wide variety of arrangement. They may be one (Photo 4) or more masses (Photos 3 and 6) or only an uneven lining to the nuclear membrane (Photo 5). The red-stained chromocenters usually lie free inside the nucleus (Photos 3-6). The demonstration of a nuclear membrane and differentially stained areas inside the nucleus in cells processed according to Lindegren *et al.*<sup>7</sup> (Photos 5 and 6) invalidates their

suggestion that the organelle is only the "spindle with chromatin" and not the nucleus.

Since the nucleolus of *Allium*<sup>8</sup> is of the same colour as the cytoplasm in Giemsa preparations, it would appear that the blue-tinted structures within the yeast nucleus (B. Photos 3-6) may correspond to the nucleolar substance of higher organisms. The yeast nucleus thus assumes a conventional structure not only in its possession of a nuclear membrane and chromocenters but also in having nucleolar equivalents.

I am very grateful to Dr. M. K. Subramaniam for his guidance and encouragement.

(MISS) SARASWATHY ROYAN.

Cytogenetics Lab.,  
Dept. of Biochemistry,  
Indian Institute of Science.  
Bangalore, May 20, 1958.

1. Royan, S. and Subramaniam, M. K., *Proc. Ind. Acad. Sci.*, 1956, **43 B**, 228.
2. 3 & 4. —, *Ibid.*, 1956 a, **44 B**, 47; 1956 b, **44 B**, 171; 1958, **47 B**, 31.
5. Thyagarajan, T. R. and Subramaniam, M. K., *Ibid.* 1957, **45 B**, 187.
6. Aswathanarayana, N. V. and Subramaniam, M. K., *Ibid.*, 1958, **47 B**, 263.
7. Lindegren, C. C., Williams, M. A. and McClary, D. O., *Antonie van Leeuwenhoek*, 1956, **22**, 1.
8. Subramanyam, S. and Subramaniam, M. K., *Curr. Sci.*, 1957, **26**, 300.

### THE EFFECT OF CORTISONE ON THE DISTRIBUTION AND CONCENTRATION OF ALKALINE PHOSPHATASE IN THE UROPYGIAL GLAND OF MALE PIGEONS

Sex hormonal regulation of the uropygial gland has been adequately demonstrated by Selye<sup>1</sup> and Kar.<sup>2,3</sup> However, the action of any extragonadal steroid on this sebaceous type of gland has not hitherto been reported and in view of this it seemed desirable to study the effect of cortisone, particularly on the cytochemical concentration of alkaline phosphatase in the uropygial gland of pigeons.

Twelve adult male pigeons were used in this study of which 6 were injected intramuscularly with cortisone acetate ("Cortogen" Schering, U.S.A.; 4 mg. daily for 7 days) and the remaining 6 were left uninjected to serve as controls. Autopsy followed 24 hours after the final injections. The uropygial glands were carefully dissected out, weighed to the nearest milligramme and fixed appropriately for histological studies. Technique of Gomori<sup>4</sup> was used for demonstration of alkaline phosphatase.

Gross examinations at autopsy revealed consistent hypertrophy of the uropygial glands of the experimental pigeons (Table I). Histo-

TABLE I  
Summary of the weight of the uropygial glands

	Weight of uropygial gland		Body weight at autopsy (gm.)
	Absolute (mg.)	Relative ‡ (per cent.)	
Uninjected Controls (6)*	52 ± 3.97 †	0.0205	251.83 ± 3.90
Cortisone treated (6)	86.5 ± 4.39	0.0358	241.11 ± 4.01

\* Figure in parenthesis indicate the number of animals.

† Standard error of the mean.

‡ Uropygial gland weight as percentage of the body-weight.

logical study also disclosed a pronounced stimulation of this organ in cortisone-treated birds. This was exhibited by an accelerated development of the alveolar system. The lumen of majority of the alveoli were filled up with sebaceous secretion and a pronounced hyperemia was also indicated in the alveolar septa. It might be recalled in this connection that contrary to the present findings, cortisone exerted practically no influence on the mammalian sebaceous glands.<sup>5</sup>

In agreement with the findings of Kar<sup>6</sup> we observed that in general, the enzyme was distributed in a diffuse manner in the gland of the normal birds. The connective tissue surrounding the alveoli showed slight reaction. The endothelium of the stromal blood vessels and the fibroblast cells exhibited a moderate enzymatic activity. Appreciable phosphatase activity was evident in the "indifferent" as well as cuboidal cells bordering the alveolar wall. The nucleus of the cells adjacent to the cuboidal epithelium showed moderate reaction, but the enzyme was totally absent from the cytoplasm of the cells. Almost negative reactions were encountered in the rest of the alveolar epithelium. Moderate phosphatase activity was evident in the luminal epithelium of the duct.

Cortisone treatment caused an augmentation in phosphatase activity. This was particularly noticeable in the basal cuboidal cells of the alveolus. The enzyme appeared to be almost uniformly distributed in the nucleus and in the cytoplasm of the cells. Cytoplasmic granules present in the alveolar epithelium also showed



a prominent reaction for alkaline phosphatase. The nuclear phosphatase activity, however, remained practically unaffected in the hormone-treated pigeons. In the stromal blood vessels the enzyme was restricted to the endothelium. The secretory substance in the alveolar lumen also showed a slight reaction for this enzyme. However, a remarkable mobilization of alkaline phosphatase was noticed in the duct epithelia.

The results obtained in the present experiment demonstrate that alkaline phosphatase activity is enhanced in the uropygial gland of the pigeon after cortisone treatment. It is suggested that in the cortisone-treated birds, a physiological relationship exists between the hypertrophy of the uropygial gland and the increase in phosphatase activity as this enzyme is known to play an important role in the lipid metabolism of the holocrine glands.<sup>7</sup>

Histophysiology                      S. P. BHATTACHARJEE.  
Laboratory,                              A. GHOSH.  
Dept. of Zoology,  
University of Calcutta,  
Calcutta-19, June 20, 1958.

1. Selye, H., *J. Morph.*, 1943, **73**, 401.
2. Kar, A. B., *Anat. Rec.*, 1947, **99**, 75.
3. —, *Nature*, 1949, **164**, 495.
4. Pearse, A. G. E., *Histochemistry—Theoretical and Applied*, J. and A. Churchill Ltd., London, 1954.
5. Haskin, D., Lasher, N. and Rothman, S., *J. Invest. Dermatol.*, 1953, **20**, 207.
6. Kar, A. B., *Proc. Nat. Inst. Sci. Ind.*, 1950, **16**, 41.
7. Montagna, W., *The Structure and Function of Skin*, Academic Press Inc., New York, 1956.

#### A NOTE ON APHIDS OF CALCUTTA AND SUBURBS WITH SPECIAL REFERENCE TO THE NEWLY RECORDED HOST PLANT FAMILIES FOR SOME OF THE SPECIES

TILL 1955, twenty-six species of aphids had been known to occur in West Bengal as plant pests. But the present investigation leads to the fact that there are twenty-seven species of aphids, including *Rhopalosiphum nymphaeae* L. which is for the first time recorded from West Bengal. Besides, for some of the known species, a few plant families are also recorded new, e.g.,

*Aphis craccivora* Koch.: Cucurbitaceae, Labiatae, Nyctaginaceae, Scitaminaceae and Urticaceae. *Aphis gossypii* Glover: Amarantaceae, Araliaceae. *Liphaphis erysimi* (Kalt.): Araliaceae, Cruciferae. *Myzus persicae* (Sulz.): Acanthaceae, Malvaceae. *Rhopalosiphum nymphaeae* L.: Cactaceae, Leguminosae. *Rhopalo-*

*siphum ruftabdominalis* (Sasaki): Araceae. *Tetranera hirsuta* Baker: Cruciferae, Solanaceae.

The authors are indebted to Dr. J. P. Doncaster of British Museum, London, for identifying a part of collections which helped them to have materials for comparison, and to Prof. A. Dasgupta, formerly Head of the Department of Botany, Bangabasi College, Calcutta, for kindly identifying the plant families.

The authors express their thanks to the authorities of St. Xavier's College, Calcutta, for granting facilities to work in Zoology Laboratory.

Zoology Laboratory,                      D. N. RAY CHAUDHURI.  
St. Xavier's College,                      A. K. GHOSH.  
Calcutta-16, June 24, 1958.

1. Benerjee, S. N. and Basu, A. N., *Curr. Sci.*, 1955, **24**, 61.
2. Takahashi, R., *Aphididae of Formosa*, 1931, Pt. VI, 1-122.

#### HOMOLOGY OF THE PAPPUS IN THE LIGHT OF TRICHOME DISTRIBUTION

HOMOLOGY of the pappus, as stated by Koch,<sup>3</sup> is still open to question. It represents a modified calyx according to the phyllome theory which was supported by Cassini, Bentham, Worsdell, Hutchinson, etc. (cf. Small<sup>6</sup> for a review of the relevant literature). This view is also adopted by systematists<sup>4</sup> in general as stated by Lawrence.<sup>4</sup> Pappus is a homologue of the trichomes or emergences according to the trichome theory which was advanced by Warming, Masters,<sup>6</sup> etc. This was upheld and greatly strengthened afterwards by Small<sup>6</sup> who studied the pappus of a large number of species and who particularly took into account its anatomical structure. The same view was followed later by Koch<sup>3</sup> who considered the problem in the light of the vascular anatomy of the ray flowers of some of the Heliantheae.

Recently, pappus of *Helianthus annuus* L. and *Vicoa indica* DC. was interpreted as phylomic in origin by the first author<sup>5</sup> on the basis of altogether a new evidence, viz., the relative distribution of sclerenchyma among the floral organs. In this note, evidence from yet another aspect is recorded which indicates that pappus originated from the calyx in some more members of the Compositae. There are several species of the family in which the pappus parts have been observed to bear trichomes which are otherwise characteristic of the vegetative

parts and other floral organs like the bracts, paleæ, corolla, ovary, etc. Similar to the latter organs the pappus parts too have an epidermal layer and the trichomes observed are differentiated from single epidermal initials as for example seen in *Adenostemma lavenia* O. Kze. (Figs. 5, 6 and 7). First the trichome initial

chome theory, because it will amount to occurrence of trichomes upon trichomes which is quite an improbable phenomenon. It is important to note that the pappus parts and the trichomes borne by them are quite dissimilar in their structure as for example may be observed in *Adenostemma lavenia* (Fig. 8). The former are relatively massive structures and consist

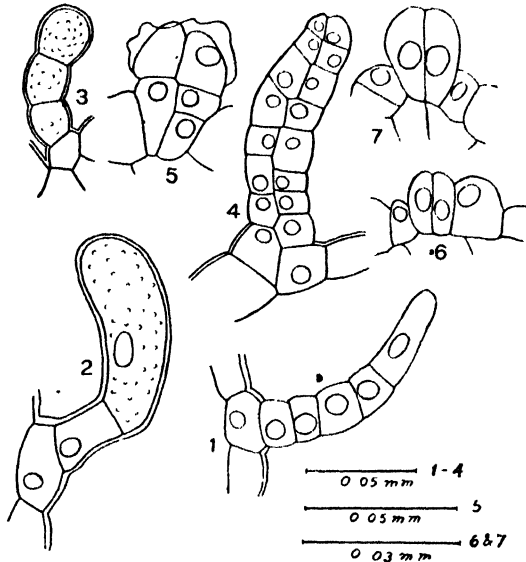

FIG. 1. Rostrate filiform hair, *Parthenium argentatum*.  
FIG. 2. Cylindrical hair, *Parthenium argentatum*.  
FIG. 3. Cylindrical hair, *Parthenium hysterophorus*.  
FIG. 4. Biseriate glandular hair, *Eriophyllum stachadisfolium*.  
FIG. 5. Biseriate vesicular glandular hair, *Adenostemma lavenia*.  
FIG. 6. Two-celled stage of biseriate vesicular glandular hair, *Adenostemma lavenia*.  
FIG. 7. Two-celled stage with the dyads enlarged, *Adenostemma lavenia*.

divides anticlinal and gives rise to two juxtaposed daughter-cells (Fig. 6). These cells later become very much enlarged in their size (Fig. 7). Further differentiation involves one to two periclinal divisions of each of the dyads followed by detachment of the cuticle from the end cells into a vesicle (Fig. 5). Trichomes may be limited in their distribution to the lateral surface of the pappus parts (e.g., *Cæsalia axillaris* Roxb.) or also occur upon the tips of the latter (e.g., *Adenostemma lavenia*, Fig. 8). They are usually a few in number but denser in *Adenostemma lavenia*. The composites noted are as in Table I.

In the species listed above, it is obvious that the pappus parts cannot be regarded as hairy-structures as explained according to the tri-



FIG. 8. Pappus part with hairy epidermis, *Adenostemma lavenia*,  $\times 410$ .

TABLE I

S. No.	Name of the species	No. of parts of the pappus	Trichome types* present on the pappus
1	2	3	4
1	<i>Adenostemma lavenia</i> O., Kze.	3-4	Biseriate vesicular glandular hair
2	<i>Parthenium hysterophorus</i> L.	2	Rostrate filiform hair and cylindrical hair
3	<i>Parthenium argentatum</i> Gray	3	do.
4	<i>Parthenium incanum</i> H. B. K.	3	do.
5	<i>Parthenium alpinum</i> (Nutt) T. & G.	2-3	do.
6	<i>Eriophyllum stachadisfolium</i> Lag.	6-9	Biseriate glandular hair

\* The names of the trichomes are adopted from the thesis to be submitted shortly by the first author.

of, apart from the hairy epidermis, ground tissue and a vascular strand. Thus, in possessing the three fundamental tissues, the pappus parts structurally resemble any other reproductive

phyllome<sup>1</sup> such as the petal, stamen or carpel, and this homology itself is another evidence of their phyllome or calyx origin. Further, they are also less in number being usually not more than five in each of the species as is evident from the above list.

It is of significance that the species were recorded after examining more than a hundred species (representing all the thirteen types of the family) in which many have the common plumose pappus consisting of numerous hair-like structures, called the setæ.<sup>6</sup> Since trichomes are not borne by the setæ, therefore, their possession by the pappus parts which are massive in size and less in number as noted in the present species, is probably not without significance. In terms of the phyllome theory, the pappus of these species can be regarded to represent a primitive type since in size, structure, and number of its parts it resembles a typical five-merous calyx such as hypothesized by Koch<sup>3</sup> to have been borne by the earliest Compositæ. The setose pappus, therefore, represents a specialised form which probably evolved later by dismemberment of the primitive type into numerous parts. Evolution of this might have obviously involved origin and selection of such mutations which had brought about a division of the normal sepal primordia into numerous bits as are now witnessed in the development of the plumose pappus of, for example, *Tridax procumbens* Linn.<sup>2</sup>

The authors are grateful to Prof. R. C. Rollins, Gray Herbarium, Harvard University, Cambridge, and Dr. B. L. Hammond, Salinas, California, for sparing the material of *Parthenium* spp.

Dept. of Botany, N. RAMIAH,  
Osmania University. M. SAYEEDUDDIN.  
Hyderabad-Dn., March 12, 1958.

1. Arber, A., *The Natural Philosophy of Plant Form*, Cambridge, 1950.
2. Banerji, I., "A contribution to the study of *Tridax procumbens* Linn.," *Jour. Bom. Nat. Hist. Soc.*, 1940, 42, 89-99.
3. Koch, M. F., "Studies in the anatomy and morphology of the Compositæ flowers, II. The corollas of the Heliantheæ and Mutisieæ," *Amer. J. Bot.*, 1930, 17, 995-1010.
4. Lawrence, G. H. M., *Taxonomy of Vascular Plants*, New York, 1955.
5. Ramiah, N., "Studies on the occurrence of sclerenchyma in the floral organs of the Compositæ, I. *Helianthus annuus* L. and III. *Vicoa indica* DC.," *Proc. Ind. Sci. Cong. Part III*, 1956, 238-39 and 240.
6. Small, J., "Origin and development of the Compositæ," 1919, Rep. from the *New Phytol.*

## INHERITANCE STUDY IN WHEAT

A LARGE number of studies have been made to determine the mode of inheritance of typical characters of the various wheat species. The genus *Triticum* has at present twenty total number of species and subspecies.<sup>2</sup> *T. durum* and *T. turgidum* both have  $n = 14$  chromosomes. The inheritance of ramified spike in *T. turgidum* and *T. durum* was undertaken at the Agricultural Research Station, Niphad, District Nasik, and the results obtained are presented in this article.

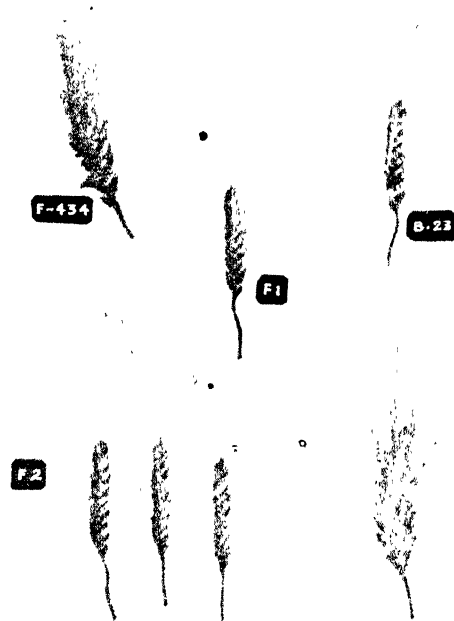

FIG. 1

Many workers<sup>3, 5</sup> have studied the behaviour of the ramified spike (branched ear) and the effect of day length and temperature on the expression of it.

F. 434, a type with ramified spike belonging to *T. turgidum* introduced from Egypt, was crossed with an improved type Baxi 23,<sup>1</sup> a *T. durum* with simple spike in the year 1952-53 and studied in the subsequent years. The F<sub>1</sub> was normal, i.e., unbranched spike, was dominant to branched spike. The fertility of the segregates was normal. The F<sub>2</sub> observations are presented in Table I and in Fig. 1.

TABLE I  
*F*<sub>2</sub> segregation in the cross *F. 434* × *Bari 23*

Phenotypes	Observed (O)	Expected (C)	O—C	(O—C) <sup>2</sup> /C
Simple spike ..	280	279	+1	0.00358
Ramified spike ..	92	93	-1	0.01075
Total ..	372	372	-	0.01433
P : 0.90 to 0.95			X <sup>2</sup> : 0.01433	

Randomly selected 54 families were studied in *F*<sub>3</sub>. The results were as in TABLE II.

TABLE II  
*Behaviour of families (segregates) in F*<sub>3</sub>

Phenotypes of families	Observed (O)	Expected (C)	O—C	(O—C) <sup>2</sup> /C
Simple ..	21	13.5	+7.5	4.16
Segregating ..	22	27.0	-5.0	0.92
Ramified ..	11	13.5	-2.5	0.46
Total ..	54	54.0	0.0	5.54
P : 0.05 to 0.1			X <sup>2</sup> : 5.54	

The goodness of fit test of the *F*<sub>2</sub> and *F*<sub>3</sub> results proved that segregation of the character ramified spike is monogenic, giving 3 simple (unbranched) to 1 ramified spike plants.

In the study of the inheritance of ramified spike in *T. turgidum* and *T. durum* at the Agricultural Research Station, Niphad, the results obtained are as below.

*F*<sub>1</sub> plants were with simple spikes, i.e., ramified spike is recessive. The segregation in *F*<sub>2</sub> was 3 simple to 1 ramified. The segregation of 54 families of *F*<sub>3</sub> was in the ratio of one homozygous simple spike; two heterozygous simple; and one homozygous ramified spike. The results confirmed the findings of Tschermak.<sup>5</sup>

I am grateful to Prof. V. M. Chavan, for his encouragement during the study, and Dr. S. Soloman, for going through the manuscript and giving valuable suggestions. Thanks are due to Sarvashri Y. N. Shaikh and M. G. Tamboli for their help in the fieldwork during the course of the present investigation.

Agric. Res. Station,  
Niphad (Bombay State),  
April 17, 1958.

J. A. PATIL.

1. Chavan, V. M., Chaudhari, B. R. and Patil, J. A., *Agric. Coll. Mag.*, 1952, 43, 1.
2. Chester, K. Starr, *Selected Writings of Vavilov*, 1951.
3. Hurd-Karrer, A. M., *J. Agri. Res.*, 1933, 46, 867.
4. Sharman, B. C., *Nature*, 1944, 153, 497-99.
5. Tschermak, E. Von, 1923, Cited by Sears, 1948.

NOTE ON ALTERNATE HOST PLANTS OF *CHILO ZONELLUS* SWINHÖE

*Chilo zonellus* Swinhöe is a major pest of Sorghums and maize and occasionally of sugarcane and is widely distributed all over India. During the investigation carried out at the College of Agriculture, Poona, Trehan and Butani<sup>1</sup> recorded this pest to breed also in Sudan grass (*Sorghum vulgare* var. *sadanense* Stapf.), *Nachini* (*Eleusine coracana* Gaertn.), *Baru*—Johnson grass (*Sorghum halepense* Pers.), Job's tears (*Coix lachryma-jobi* L.) and *Kawdia* (*Polytoca barbata* Stapf.), etc. These grasses, growing wild in various fields, on the pastures and along the bunds and water channels were found to harbour the pest during the off-season. Similarly, voluntary *jowar* plants that germinated from the scattered seeds in the fields and farmyards, etc., also afforded most suitable host plants for the pest to flourish. A good many 'dead hearts' were collected from these alternate hosts. A detailed study revealed that the maximum infestation was during the month of July, when the average infestation recorded was 45.2%, 48.4%, 48.7% and 51.0% in *P. barbata*, *Andropogon sorghum*, *A. halepense* and *S. sudanense* respectively.

The observation recorded suggested that the wild grasses and the voluntary *jowar* plants definitely serve as breeding places for *Chilo zonellus* as they afford most suitable facilities for the moths, to lay their eggs on these plants, where they hatch out and feed on them till the new crop comes up. To avoid the carry-over of the pest it is necessary to eliminate the availability of these alternate hosts, for which clean cultivation is advocated.

Sincere thanks are due to Dr. K. N. Trehan, under whose able guidance this work was conducted at the College of Agriculture, Poona.

Pusa, Bihar, DHAMO. K. BUTANI.  
August 17, 1957.

1. Trehan, K. N. and Butani, D. K., *Indian J. Ent.*, 1949, 11, 47-59.

CHROMOSOME NUMBER IN *IBERIS* *UMBELLATA* L.

EXCEPTING the conflicting reports on chromosome number<sup>1,2</sup> no other cytological work has been done in *Iberis umbellata* L. This note deals with the meiotic behaviour of chromosomes in the species and a discussion of its probable chromosome number. Majority of pollen mother-cells at diakinesis and metaphase I had

nine bivalents (Figs. 1 and 3); a few, however, showed eight bivalents and two univalents (Fig. 2). The distribution of chromosomes at

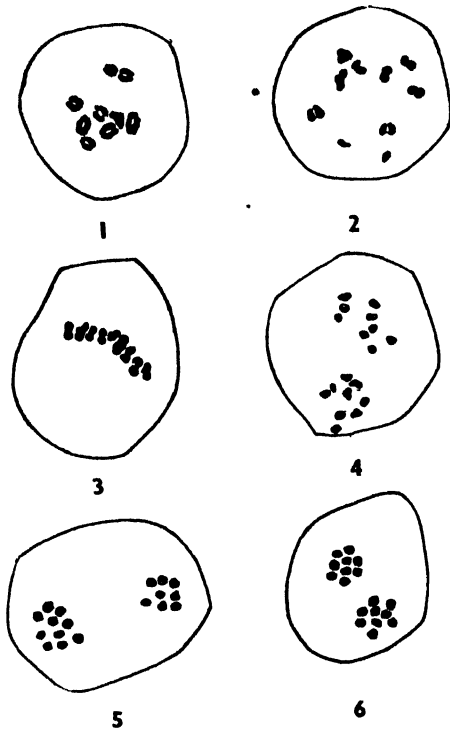

FIGS. 1-6 ( $\times 1,700$ ). Meiotic stages. Figs. 1-2. Diakinesis. Fig. 1. Nine bivalents. Fig. 2. Eight bivalents and two univalents. Fig. 3. Metaphase I, showing nine bivalents. Figs. 4-5. Anaphase I. Fig. 4. Nine chromosomes at either pole. Fig. 5. Showing 8 + 10 distribution of chromosomes. Fig. 6. Metaphase II showing nine chromosomes in each group.

anaphase I was quite regular, nine chromosomes being clearly seen at either pole (Fig. 4). A few of the pollen mother-cells, however, showed an unequal distribution of chromosomes, eight going to one pole and ten to the other (Fig. 5). Nine chromosomes were included in each group at metaphase II (Fig. 6). Manton<sup>2</sup> working with the somatic nuclei of *I. umbellata*, reported fourteen as its diploid chromosome number. Thomas,<sup>1</sup> however, found  $2n = 16$ . Our observations indicate that the haploid chromosome number in this plant is nine ( $2n = 18$ ). *I. umbellata* thus shows three types with reference to its chromosome number.

We are thankful to Prof. P. Maheshwari,

Head of the Department of Botany, University of Delhi, for the facilities and encouragement.

Dept. of Botany,  
University of Delhi,  
Delhi-8, May 5, 1958.

P. N. BALI.\*  
S. L. TANDON.

\* Lecturer in Botany, Hansraj College, University of Delhi, Delhi 8.

1. Darlington, C. D. and Wylie, A. P., *Chromosome Atlas of Flowering Plants*, George Allen & Unwin Ltd., London, 1955.
2. Manton, I., *Ann. Bot.*, 1932, **46**, 509.

### CHROMOSOME NUMBER IN *CHLOROPHYTUM TUBEROSUM*, BAKER

THERE are more than 50 species in the genus *Chlorophytum*, Ker. distributed in the tropics of both hemispheres.<sup>1</sup> Till now, the chromosome number has been worked out only in 10 species, and *C. tuberosum* has not been included in the list.<sup>2</sup> Therefore, the authors presume that the haploid chromosome number ( $n = 8$ ) determined for *C. tuberosum*, to have been reported here, for the first time.

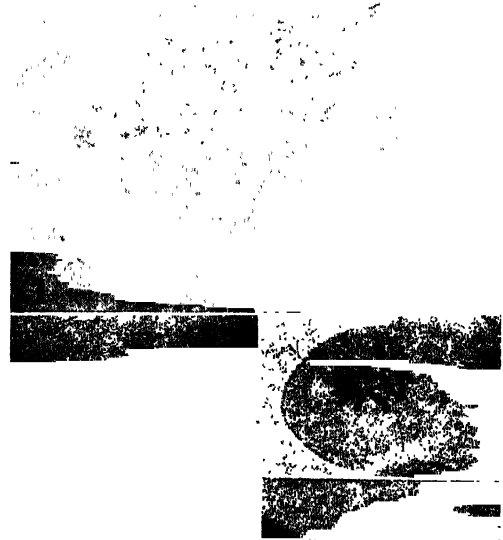

FIG. 1. Diplotene 8<sub>II</sub>. FIG. 2. Anaphase-I. Bridge with fragment. FIG. 3. Pollen mitosis  $N=8$ . FIG. 4. Pollen mitosis anaphase. All photomicrographs at magnification,  $\times 1,000$  ca.

*C. tuberosum* is found in abundance growing as a weed during early monsoon in Poona. It is reported that *C. tuberosum* is also sometimes cultivated in gardens as its tender leaves are used as 'Pot herbs' and its flowers as ornamentals, kept in vases. It is a short-lived, small herb with tuberous roots. The leaves are

TABLE I  
Chiasma frequency at diplotene in *C. tuberosum*

No. of P.M.C.'s examined	Chiasmata					
	Total for 50 P.M.C.'s		Per cell		Per each bivalent	
	Interstitial	Terminal	Interstitial	Terminal	Interstitial	Terminal
50	780	370	15.6	7.4	1.3	1.4
Total ..	1150		23.0		1.4	1.3
					1.3	0.0
					1.2	1.1
					2.2	1.3
					3.0	1.1
					3.1	1.2
					2.1	0.0

sessile, radiate, falcate, recurved and wavy. The plant bears white flowers during July-August. Although the plant soon dies off, during the next monsoon, the underground tubers once again sprout up.

Chromosome number was determined by meiotic studies. For this purpose, flower-buds were fixed in Carnoy's (6<sup>h</sup>: 3: 1) and permanent Feulgen and Propiono-carmin squashes were prepared. At diplotene (Fig. 1), diakinesis and metaphase-I of meiosis in microsporocytes, there were 8 bivalents. The chiasma frequency per bivalent observed is presented in Table I.

At anaphase I (Fig. 2), 0.12% abnormality in the form of inversion bridges with fragments were noticed. Pollen mitosis (Fig. 3) also revealed the haploid number to be 8, in *C. tuberosum*. Anaphase of pollen mitosis (Fig. 4) was, however, normal.

The presence of inversion bridges indicates structural hybridity of the *C. tuberosum* species. Sheriff (1957)<sup>1</sup> reports spontaneous chromosome inversions in *C. elatum*, R.Br. The genetic role of inversions in evolution has been well brought out by Dobzhansky (1955).<sup>3</sup>

A critical study on the cytological behaviour in the genus *Chlorophytum* where spontaneous inversion hybrids are suspected, has been now undertaken.

Botany Dept., L. S. S. KUMAR.  
College of Agriculture, H. K. SHAMA RAO.  
Poona-5, May 2, 1958.

1. Cooke, T., *The Flora of the Presidency of Bombay*, 1903.
2. Darlington, C. D. and Wylie, A. P., *Chromosome Atlas of Flowering Plants*, 2nd Ed., George Allen and Unwin Ltd., London, 1955, 365.
3. Dobzhansky, T., *Evolution, Genetics and Man*, John Wiley & Sons, Inc., New York, 1955.
4. Sheriff, A., "Spontaneous chromosome inversions in *Chlorophytum elatum*, R.Br.," *J. Indian Bot. Soc.*, 1957, **36**, 222-38.

#### A PRELIMINARY STUDY OF COLCHICINE-INDUCED POLYPOIDS OF *ALYSSUM MARITIMUM* LAM.

THE authors have recently published work done on Colchicine-induced tetraploidy in *Iberis amara* L. and *Linaria vulgaris*.<sup>1-3,7,8</sup> This paper deals with a similar type of work on *Alyssum maritimum* (Sweet Alyssum) which is an important winter annual garden plant.

The apical growing points of 46-days old seedlings having 8 leaves on an average, which were covered with small cotton wads which were kept moist with aqueous colchicine solution. The treatments employed were 0.05, 0.10 and 0.20% colchicine solution for 6 and 12 hr. Ten plants were used for each treatment. The most successful treatment was found to be 0.20% colchicine solution applied for 6 hr. The leaves which came out after the treatment were longer, broader, thicker, more rough and deep green in colour as compared to those of the control. The average thickness of leaves in the control and the polyploid was 327.25  $\mu$  and 500.50  $\mu$  respectively. The deep green colour of the leaves in the polyploid plants was found to be due to the presence of more numerous and larger chloroplasts. The epidermal hairs, epidermal cells, stomata, cells of the palisade and spongy parenchyma of leaves in the polyploids were larger than those of the control. The guard cells of the stomata of the untreated plants average 21.28  $\mu$  in length and 5.47  $\mu$  in width as compared with an average length and width of 44.59  $\mu$  and 11.75  $\mu$  respectively in the polyploids. The number of stomata per sq. mm. in the control and polyploid was 221.68 and 83.13 respectively.

Flowering was delayed and extended in the polyploid plants. The polyploids had conspicuously large flowers. The pedicel, sepals, petals, stamens, pistil, ovules, fruit, seed and embryo

of the polyploid plants showed a general enlargement over their counterparts in the control. It may, however, be mentioned that a few of the polyploid plants showed a reduction in flower size. The percentage of pollen fertility in the polyploid plants was rather low, the averages for the control and the polyploid being 95.58% and 76.06% respectively. The fertile pollen grains of the polyploids were larger than those of the control, the average diameter of the pollen grains of the polyploid and the control being 39.52  $\mu$  and 21.68  $\mu$  respectively. Fruit and seed-setting in the polyploids was extremely poor but this handicap could possibly be overcome by leaving a larger number of plants for seed collection.

The colchicine-treated plants were cytologically analysed. Squashes of pollen mother-cells were stained with aceto-orcein. The meiotic chromosome numbers of the control plants and the polyploids were determined as 12 and 24 respectively. It is worthwhile to mention here that taking the genus *Alyssum* as a whole, the naturally occurring *A. maritimum* is at a triploid level.<sup>5,6</sup> The artificially induced polyploids would thus represent a hexaploid condition. The control plants showed 12 bivalents at diakinesis and metaphase I. The distribution of chromosomes at anaphase I was mostly regular in the control plants, 12 chromosomes going to either pole. The details of meiosis in the naturally occurring triploid *A. maritimum* have been reported elsewhere.<sup>4</sup> Many of the possible configurations showing varying numbers of quadrivalents, bivalents and univalents were seen in the preparations of the polyploid plants. Twelve quadrivalents were also seen at diakinesis. In some of the pollen mother-cells the distribution of chromosomes was quite regular but in many of them a few chromosomes were seen to lag behind resulting in the unequal distribution of chromosomes. In a few pollen mother-cells anaphasic bridges were also observed. The wall formation in the control and polyploid was of the simultaneous type. Formation of varying numbers of multivalents, lagging chromosomes at anaphase, and formation of chromosome bridges, etc., may be the probable causes for low pollen fertility and consequently poor fruit and seed-setting in the polyploids.

We are thankful to Prof. P. Maheshwari, Head of the Department of Botany, University of Delhi, for the facilities and encouragement.

Dept. of Botany,  
University of Delhi,  
Delhi-8, May 5, 1958.

P. N. BALI\*  
S. L. TANDON.

\* Lecturer in Botany, Hansraj College, University of Delhi, Delhi 8.

1. Bali, P. N. and Tandon, S. L., *Indian J. Hort.*, 1956, **13**, 149.
2. — and —, *Curr. Sci.*, 1957, **26**, 256.
3. — and —, *Phyton*, 1957, **9**, 107.
4. — and —, *Indian J. Hort.* (in press).
5. Darlington, C. D. and Wylie, A. P., *Chromosome Atlas of Flowering Plants*, George Alien and Unwin, Ltd., London, 1955.
6. Manton, I., *Ann. Bot.*, 1932, **46**, 509.
7. Tandon, S. L. and Bali, P. N. *Curr. Sci.*, 1957, **26**, 357.
8. — and —, *Genetics*, 1957, **29**, 101.

### IODINE CONTENT OF SOME INDIAN FODDER PLANTS

ACCORDING to Underwood,<sup>4</sup> subnormal levels of iodine in soils and hence in foods and waters of certain parts of the world can be correlated with the incidence of goitre in humans and animals. However, there is no data on the iodine content of Indian plants and foods except Lander's<sup>2</sup> who found that goitre was notoriously prevalent in Kashmir and some of the districts of the Himalayan foot-hills in the Punjab and that the iodine content of fodder plants from Kangra and Murree were far lower than those of the plains.

The iodine content of pasture plants, though of no significance to the plants themselves are of profound importance to the animals dependent upon them. A preliminary survey of the iodine status of the grassland soils of Western India revealed that the total iodine content was negligible, varying from 0.00 to 0.91 p.p.m. Therefore, the iodine content of some important fodder plants was determined by the method of Houston<sup>1</sup> and the minimum, maximum and the mean contents of iodine in 22 species are reported in Table I.

Table I shows that the fodder plants of Western India contain very low amounts of iodine. The maximum iodine content was 0.076 p.p.m. in a sample of *Dicanthium annulatum* and the minimum was 0.002 p.p.m. in *Pseudanthistiria heteroclita*. The range in the average iodine content of the samples was from 0.006 to 0.048 p.p.m. A few common weeds of the grasslands (samples 19 to 22) which were also analysed for their iodine content did not appear to contain any significant amounts. The outstanding feature of the data are the wide variations in the iodine content of the same species as well as of different species growing in the same locality and soil type.

Russel<sup>3</sup> has shown that New Zealand pastures contain from 0.024 to 0.072 p.p.m. iodine

TABLE I  
Iodine content of some fodder plants and weeds  
(in p.p.m. of dry matter)

No.	Name of Species	Min.	Max.	Mean	No of samples analysed
1	<i>Pseudanthistiria heteroclita</i> Hk.	0.002	0.034	0.021	6
2	<i>Themeda triandra</i> Forsk.	0.008	0.023	0.018	10
3	<i>Themeda tremula</i> Hk.	0.001	0.009	0.006	5
4	<i>Licanthium annulatum</i> Stapf.	0.012	0.076	0.045	8
5	<i>Ischemum ciliare</i> Retz.	0.010	0.029	0.026	6
6	<i>Cymbopogon martinii</i> Stapf.	0.006	0.017	0.017	4
7	<i>Nulalia umbriata</i> Bl. & Mc.	0.009	0.027	0.014	5
8	<i>Arthraxon m. boldii</i> Stapf.	0.011	0.040	0.022	6
9	<i>Heteropogon contortus</i> Beauv.	0.024	0.068	0.046	10
10	<i>Arundinella tenella</i> Lawii.	0.010	0.054	0.023	4
11	<i>Spodiopogon albidus</i> Benth.	0.014	0.043	0.029	4
12	<i>Indigofera tinctoria</i> Linn.	0.023	0.040	0.035	6
13	<i>Crotalaria triquetra</i> Dalz.	0.011	0.031	0.020	4
14	<i>Helymania lutebrosa</i> DC.	0.004	0.010	0.006	8
15	<i>Crotalaria lunifolia</i> Linn.	0.009	0.027	0.018	4
16	<i>Alysicarpus vaginalis</i> DC.	0.021	0.053	0.038	6
17	<i>Smithia senutiva</i> Nit.	0.008	0.026	0.012	5
18	<i>Zornia diphylla</i> Pers.	0.026	0.049	0.022	6
19	<i>Glossocardia linearifolia</i> Cav.	0.014	0.020	0.015	6
20	<i>Borreria stricta</i> Schum.	0.005	0.016	0.006	4
21	<i>Lindernia ciliata</i> Linn	0.021	0.036	0.024	4
22	<i>Vicco indica</i> DC.	0.041	0.052	0.048	4

whereas English pastures contain from 0.21 to 0.84 p.p.m. Lander's values for the iodine content of the Punjab grasses appears to be rather high, varying from 0.118 to 0.902 p.p.m. The fodder hays from the goitre areas of Murree and Kangra, contain according to him, from 0.118 to 0.380 p.p.m. iodine. Probably these samples were contaminated. As compared to Lander's values, the fodder plants of Western India appear to be very poor in their iodine content. However, it was beyond the scope of this investigator to study whether goitre is prevalent in the area. A co-ordinated approach by the Veterinary and Agricultural Departments may yield interesting results.

Dept. of Botany, (MISS) JAYA G. IYER.  
Institute of Science,  
Bombay-1. June 10, 1958.

- Houston, F. G., *Anal. Chem.*, 1950, **22**, 493
- Lander, P. E., *I.C.A.R. Misc. Bull.*, 1942, **16**, 113.
- Russel, F. C., *Aberdeen Tech. Communs.*, 1944, No. 15.
- Underwood, E. J., *Trace Elements in Human and Animal Nutrition*, Academic Press, 1956.

#### A SHORT NOTE ON SOME OF THE INDIAN SOLANUM SPECIES

NEARLY 20 Solanum species grow wild in India and some investigations have been carried out on many of these. However, *Solanum indicum*,

*S. luteum* and *S. verbascifolium*, growing wild in Northern India, have not so far been properly investigated and nothing is known regarding the nature of alkaloids, present in them. A systematic study of the berries of these species was therefore carried out.

Coarsely powdered dry berries were extracted with alcohol in a sauxhlet. The solvent was removed and the alkaloid extracted with 5% acetic acid. The fatty matter and other extraneous impurities were removed by shaking the aqueous solution with petroleum ether and benzene, after which the gluco-alkaloid was precipitated with ammonia. It was repeatedly crystallised from alcohol.

The gluco-alkaloid was subsequently hydrolysed with 5% hydrochloric acid, decomposed with ammonia and crystallised from alcohol. The alkaloid obtained was further characterised by preparing its acetyl derivative. The results of our observations are given in Table I.

Mixed melting points with gluco-alkaloid solasonine and alkaloid solasodine, isolated from *S. xanthocarpum*, were taken and no depression was observed. When alcoholic solution of the alkaloid was treated with sulphuric acid, a green fluorescence, characteristic of solasodine, was produced. The alkaloid also gave characteristic colour reaction with anisaldehyde and hydrochloric acid.



TABLE I

	<i>Solanum indicum</i>	<i>S. verbascifolium</i>	<i>S. luteum</i>
Gluco-alkaloid ..	Softened at 192°; m.p. 275-78° (decomp.)	Swells at 190°; m.p. 276-78° (decomp.)	Softened at 228°; m.p. 273-75° (decomp.)
Alkaloid hydrochloride ..	m.p. 308-10°	m.p. 304-05°	m.p. 305-08°
Alkaloid ..	m.p. 201-02°	m.p. 201-02°	m.p. 201-02°
Acetate of alkaloid ..	m.p. 191-93°	m.p. 191-92°	m.p. 189-91°

A perusal of the above shows that all the above solanum species contain the gluco-alkaloid solanone, which on hydrolysis with 5% hydrochloric acid yields the alkaloid solanodine.

Regional Res. Lab.,  
Jammu,  
June 10, 1958.

S. S. CHAUDHARY.  
VISHWA PAUL.  
K. L. HANDA.

#### OCCURRENCE OF ISOETES IN MADHYA PRADESH

THERE are about 65 species<sup>1</sup> of *Isaetes* but only four have been recorded in India. These are *I. coromandelina* L.,<sup>2,3</sup> *I. sahyadrii*,<sup>4</sup> *I. sampat-kumaranii*<sup>5</sup> and *I. dixitei*.<sup>6</sup> So far, none have been recorded from Madhya Pradesh, one of the largest States of India. The authors have observed a species of *Isaetes* growing abundantly at Omkareshwar and this note deals with the preliminary aspect of its occurrence.

Omkareshwar is a famous sacred place of Hindus, situated on the banks of River Narbada. Its height is 579.7' above sea-level and the climate is not much different from that of Indore.

One of us (Mr. Patel), while visiting this place on 9th October 1955, accidentally discovered *Isaetes* plants growing with grasses, in a slow-running temporary stream. Subsequent observations of this locality in different seasons, for about 3 years, clearly indicate that this plant has a definite growing season, which starts in mid-June, i.e., after the beginning of monsoon and continues till October. In addition to the short span of life, these plants are very much restricted in distribution, as it is clear from their absence in similar places within a radius of 7 miles.

The plants vary from 15.5 cm. to 40 cm. in height and are mostly bisporangiate with a definite order of arrangement of the sporophylls.

The species reported here differs from the previously described species and is in all probability a new one. However, further critical study is continued to ensure this.

Dept. of Botany,  
Holkar College,  
Indore, April 28, 1958.

RAMJI SHARMA.  
R. M. PATEL.\*  
S. S. MUGHE.

- \* Department of Biology, P.M.B.G. College, Indore.
1. Smith, G. M., *A Text-Book of Cryptogamic Botany*, 1955, 2.
  2. Mc Cann, C., *Jour. Bom. Nat. His. Soc.*, 1934, 37.
  3. Ekambaram, T. and Venkatanathan, T., *Jour. Ind. Bot. Soc.*, 1933, 12.
  4. Mahabale, T. S., *Curr. Sci.*, 1938, 7.
  5. Rao, Narayan, L., *Ibid.*, 1944, 13.
  6. Shende, D. E., *Jour. Bom. Uni.*, 1945, 14 (New Series).

#### OCCURRENCE OF A GREEN JASSID— *EMPOASCA* SP.—ON *SESBANIA* *SPECIOSA* L.

AN instance of a heavy occurrence of a small green jassid belonging to the genus *Empoasca*, was noted for the first time on *Sesbania speciosa* L. during 1955 at the Agricultural Research Station, Aduthurai, where this green manure plant used to be raised as a pure crop, to a large extent, year after year, for the manuring of paddy. The pest flared up into sudden prominence on the crop during the month of September. Due to the sucking activity of the adults and nymphs of the insect, the leaves turned pale, shrivelled up and shed in large numbers. Attempts made towards the control of the pest revealed that D.D.T. 5% dust was quite effective. Application of the chemical by means of a rotary duster at the rate of about 20 lb. per acre secured an excellent extermination of the pest in the course of about 48 hours.

Subsequently, the insect was found invading the bitter gourd. The application of H.E.T.P. 0.1% spray was quite suitable as it secured an effective control of the pest and was at the same time free from any phytocidal action.

The author's thanks are due to the Head of the Division of Entomology, Indian Agricultural Research Institute, New Delhi, for kindly identifying the insect as *Empoasca* sp.

Agric. College and Res.  
Inst., Coimbatore,  
June 16, 1958.

E. V. ABRAHAM.

---

---

## REVIEWS

---

---

**Energetics in Biochemical Reactions.** By Irving M. Klotz. (Academic Press, New York), 1957. Pp. xv + 502. Price \$ 12.80.

The increasing tendency to interpret biological phenomena in terms of conceptions that have advanced our knowledge of simple chemical reactions leaves the average biologist bewildered. The thermodynamic approach in the usual run of monographs generally keeps them off. While one may expect from the title an approach of the Bronsted school, fortunately for the non-professional physical chemist the present monograph deals largely with the classical approach. The lucid treatment of thermodynamics by Professor Klotz in an earlier monograph leads one to expect a clear non-mathematical exposition, which can be readily followed by a non-mathematician and the reader will not be disappointed. The concepts of energy and of entropy are clearly presented with suitable examples (there may be difference of opinion in one or two instances) and the student is led on to free energy and its relation to concentration. The basic concept of group transfer, electrochemical relationships and a glimpse of molecular statistics follow in succeeding chapters. The book can be safely recommended to any biologist who desires to acquire a reading knowledge of the language of the physical chemist without the rigours of a mathematical approach used by the specialist. The book is well produced and free from misprints.

S. V. ANANTAKRISHNAN.

---

**Guided Weapons.** By E. Burgess, F.R.A.S. (Chapman & Hall, Ltd., London), 1957. Pp. 255. Price 25 sh.

It is impossible at the present time to write a really satisfactory book on guided weapons owing to the classified nature of much of the most interesting material. This book makes a very laudable attempt to present all the available information on current and past weapons in a form to suit the "intelligent layman".

The first four chapters deal with the principles on which missiles are designed and cover propulsion, guidance, control and testing procedures. The presentation is completely non-mathematical and draws its examples, as far as possible, from current equipments which are sometimes given in a degree of detail some-

what at variance with the general nature of the main argument.

The next three chapters deal with actual missiles, ground-to-air, air-to-air, air-to-ground and ground-to-ground, and the final chapter deals with production and development problems. The examples in this part of the text are almost wholly taken from German war-time projects and American current developments, the little information that is given on British weapons is largely a matter of conjecture.

The amount of available unclassified information varies considerably from weapon to weapon which makes it difficult for the author to preserve a uniform narrative style. The readability of this part of the book is further marred by quoting an unnecessary number of detailed mechanical dimensions, each of which is given both in inches and centimetres. Since these figures are repeated in tables at the end of each chapter, they could, with advantage, have been largely omitted from the script.

The general format of the book is good and the text is profusely illustrated with drawings and photographs, many of them of actual weapons in flight or on the launcher. Each chapter ends with an impressive list of references, mainly to magazine articles, and the book ends with a bibliography and a useful index.

C. H. S.

---

**Atomic Radiation Dangers and What They Mean to You.** By H. W. Heckstall-Smith. (J. M. Dent & Sons, Ltd., London, W.C. 2), 1958. Pp. xii + 106. Price 7 sh. 6 d.

This little monograph presents the effects of natural radiation, man-made, industrial, medical and similar radiations, as also A-Bomb, H-bomb and atomic plant radiation on us in an impartial manner. Publication of a book of this type is to be welcomed, particularly because nowadays observations on the effects of radiation do not reach us in an unbiased form. The subject is of topical importance in view of the activities of the big powers concerning the manufacture and testing of atomic weapons. The author aims at presenting facts in a proper perspective—"facts of ignorance as well as facts of knowledge and at making them understandable by non-scientists".

The book is divided into eight chapters in the first two of which are given the necessary in-

troductory information regarding atomic radiation and their effect on living creatures. Then follow three chapters dealing respectively with natural radiation, man-caused radiation and nuclear explosions. The next two chapters are on the genetic danger and the cancer danger caused respectively by radiocæsium and radiostrontium. The last chapter is on hazards associated with nuclear reactors and the lessons one ought to learn from accidents like those which occurred at the Chalk River and Windscale.

The author has given the main facts without assuming any previous knowledge so that the book can be read and understood even by "ordinary readers" who are not men of science.

This is indeed a book which every thinking man ought to read and study and thereby assess the real situation regarding the dangers of atomic radiation and atomic tests in their proper perspective. Any one who reads the book even in a cursory way will at once realise two important things. One is that there is perhaps a shortage of high level scientific men compared to the high level responsible work which has to be carried on. The other is that unbiassed knowledge about the hazards associated with atomic energy is not sufficiently widespread.

S. RAMA SWAMY.

---

**Film Formation, Film Properties, and Film Deterioration.** By Charles R. Bragdon (Technical Editor). (Published by Interscience Publishers, Inc., New York), 1958. Pp. 422. Price \$ 9.75.

This publication typifies how a group of energetic men interested in paints and varnishes can make a positive contribution to the basic understanding of the phenomena which occur during life-time of a 'paint' film. It represents the results of a co-ordinated programme of research conducted over a decade by a team of experts in the field and organised by the Federation of Paint and Varnish Production Clubs, a technical organisation of the Paint and Varnish Industry in the United States of America.

How this research programme was visualised, various projects chalked out, results were correlated and evaluated are described in Chapter I. Chapters II and III describe the preparation of various compounds like driers, paint vehicles, esters and their pigmentation, under standard conditions and procedures so that uniformity and comparability of results could be achieved. The gain in weight of the test films, analysis of the films and their solvent resistance are dealt with in detail in Chapter IV

supported by a number of tables of results. Data obtained by infrared and ultraviolet spectroscopy of the various paint films are brought out well in Chapter V to augment the results obtained by chemical analysis. Outdoor exposure tests and accelerated weathering in a Weather-Ometer accompanied by hardness and abrasion tests are described in the two subsequent chapters. Correlation of results of outdoor tests with those of Weather-Ometer is difficult and a rough estimation has been made after making a few allowances. Alkyds are reported to be markedly superior to the esters in the series of samples prepared. The next two chapters are devoted to yellowing, diminishing of gloss, porosity, permeability, water and alkali resistance of organic coatings mentioned in the project programme. Chapter X describes the oxygen penetration and shrinkage of films while Chapter XIII deals with oxidation studies. The protection afforded by a paint film depends on its adhesion and ability to withstand the strains developed during the various seasons. Stress and strain properties of paint film are given in Chapter XI. In the next chapter molecular size, shape and weight of paint film are evaluated. In the last but one chapter a survey of the entire project is made by statistical analysis of data obtained in various projects. All the results obtained from various projects are summed up in the last chapter and appropriate conclusions are drawn from the results of data. The present studies have demonstrated that no formulation is possible that will be ideal with respect to all desired properties of a paint film.

The book has been well compiled with care and at the end of each chapter references have been cited. The editor has dealt with the large amount of experimental data in an effective fashion and this book will be of interest to all those who wish to understand about the complexity of paint formulation and will provide a stimulus to further research in this field.

S. KRISHNAMURTHY.

---

**The Chemistry of Natural Products, Vol. 1. (The Alkaloids.)** By K. W. Bentley. (Interscience Publishers, Inc.), 1957. Pp. vii + 237. Price \$ 4.00.

This is the first volume of a series planned by Interscience Publishers Inc., on the chemistry of natural products. Only recently, a five-volume treatise has appeared on the chemistry of alkaloids under the editorship of Dr. R. H. F. Manske. The task of presenting the same subject in a brief volume of less than 250 pages is

bound to offer difficulties in the matter of choice and emphasis of topics. Dr. Bentley has discussed the elucidation of structure of representative members from various groups of alkaloids. Only the minimum information required to arrive at a particular structure is presented. In many cases if the same material is presented as an examination answer by students, it will be considered inadequate. Students will find it difficult to comprehend the chapter on biogenetic relationships, in which the treatment is mainly through formulæ. There is a danger of the student ascribing reality to the numerous compounds postulated as intermediates in biogenetic pathway, unless the speculative nature of these schemes is emphasised. The author could have cut down his treatment of the morphine alkaloids and included material on the Rauwolfia and Amaryllidaceæ alkaloids on which a great deal of work has been done in recent years. It is unfortunate that although the formulæ are clearly drawn, there are a number of errors. The book will certainly prove useful to students preparing for examinations. The good format and the reasonable price are features in favour of the book. T. R. G.

**Semimicro Qualitative Organic Analysis.** (*The Systematic Identification of Organic Compounds.*) (Second Edition.) By Nicholas D. Cheronis and John B. Entrikin. (Interscience Publishers, Inc.), 1957. Pp. 774. Price \$9.00.

The volume under review runs to 774 pages and is undoubtedly the most comprehensive book available on qualitative organic analysis. Part I, occupying 158 pages, is concerned with a clear description of the equipment and techniques used in organic analysis. The authors are not content with describing only the simpler apparatus required at the undergraduate level but deal exhaustively with semi-micro apparatus of various types which will be found to be of great value to the research worker. The inclusion of adsorption, partition and ion-exchange chromatography among purification procedures is an excellent feature. Techniques of determination of physical constants like melting and boiling points, refractive index and optical rotation are fully described and the application of these data in the characterisation of organic compounds discussed.

Part II, occupying 160 pages, is concerned with procedures for the tentative identification of organic compounds. One of the most valuable features of this Part is the section on general tests for functional groups. Many novel reagents

are introduced, which are rarely described in other books on qualitative organic analysis. An unusual feature is the inclusion of the use of infrared spectroscopy in the detection of functional groups. This must have been done in order to impress upon the student the advances made recently in techniques, rather than with the purpose of training the student in infrared spectroscopy. It is doubtful whether even in the prosperous United States, undergraduates will be given access to these costly instruments for routine use in qualitative analysis. The treatment is too brief to be of use to the research worker.

Part III, occupying 212 pages, is concerned solely with the methods for the preparation of derivatives of organic compounds. Few other books deal at such great length or incorporate such useful details on the preparation of a variety of derivatives. This Part of the book will be of invaluable help to the research worker who is often faced with the problem of obtaining crystalline derivatives of compounds encountered in the course of research for purposes of analysis and characterisation.

In Part IV, the physical constants of a large number of organic compounds with different types of functional groups and of suitable derivatives of these are presented. This section will be extremely useful to the student in identifying the organic compound on which he has carried out a systematic analysis.

The massive size of the book and its high price will make it unsuitable for use by undergraduates in India studying chemistry, since the time devoted to organic qualitative analysis is very brief. Teachers in charge of instruction in organic analysis, post-graduate students and research workers will find the book invaluable. The book deserves to be known and used more widely than at present in institutions in India teaching organic chemistry. T. R. G.

**Disinfectants—Their Values and Uses.** By W. E. Finch. (Chapman & Hall, Ltd., London), 1958. Pp. 188. Price 30 sh.

There are quite a number of books on anti-septics which are valuable for reference and study. The book under review is somewhat different because it is not just a compilation of known work on the subject but it is the fruit of the rich experience of the author who has spent most of his working life in trying out details of assessing the value of various disinfectants and has himself had to work out formulations which are most efficacious.

The author has made critical analysis of

existing tests for evaluating antiseptics and stresses the importance of environment in the technical procedures.

The book contains nine chapters with a glossary of words and phrases and has both an author's index and subject index. Adequate references are given at the end of each chapter.

A chapter is devoted to formulation methods and the principles involved. Few books contain such detailed account of this subject which appear to be very important in producing active and stable disinfectants. The mysteries of the black and white fluids and the lysol types are explained as no other book does.

The chapter on surface sterilisation of fabrics like blankets and that of the skin is very enlightening as these do not just pass on information gleaned from other sources but also contain details of experiments which are of special interest.

The chapter on Hypochlorites is very welcome as there is an inclination to discredit these cheap and older disinfectants.

The chapters on Q.A.C. and substituted phenols are well worth reading. In these days of indiscriminate use of antibiotics and other chemotherapeutic agents, it is refreshing to know that the older antiseptics have still their own place.

This is a timely publication and, as Professor H. Berry points out in his Foreword, the book is certain to be welcomed by research workers, manufacturers and all those users of disinfectants who take an intelligent and responsible interest in these important products.

J. C. D.

**The Leukemias. (Etiology, Pathophysiology and Treatment.)** Edited by J. W. Rebuck, F. H. Bethell and R. W. Monto. (Academic Press, New York), 1957. Pp. vii + 711. Price \$ 13.00.

The book records the proceedings of an International Symposium on the Leukemias, organised by the Henry Ford Hospital, Detroit, from March 8-10, 1956. It has been stated in its Preface that it "is in a very real sense the result of co-operative effort". Almost every facet of the subject such as the structure and antigenicity of the leukemic cell, the genetic and environmental factors in the transmission of the disease, radiation biology of leukocytes, the physiology of leukocytes and the various chemical, diagnostic and nosological problems concerning the disease, as well as its modern therapy, have been discussed by leading research

workers in these different fields with admirable clarity.

The advances made in the knowledge of the group of diseases (Leukemias) during the last 30 years have been far-reaching but complex. Consequently, to get a fair appraisal of these advances it was necessary, not only to study the problems of the finer structure of cells with electron microscopy, but also with the aid of "immunological, biochemical, metabolic, microbiologic, endocrine, genetic, toxicologic and isotopic routes".

In the latter half of the volume, an attempt has been made to present as complete a biochemical picture as possible. Part VI, for example, deals with fundamental studies on amino acid and nucleic acid metabolism in leukemic patients. The excretion of  $\beta$ -amino isobutyric acid and studies with cystein metabolism in leukemic patients reported by Awapara and Weisburger respectively are noteworthy. Particularly interesting are the results obtained with selenium cystein as an anti-leukemic substance. The paper by Krakoff on the excretion of uric acid in human patients treated with various anti-leukemic drugs needs special mention. On the basis of serum uric acid determinations 2 to 3 times a week and daily uric acid excretion in patients, certain tentative hypotheses have been advanced "about the mechanism of the uric acid abnormality in leukemia and the relationship of this mechanism to the therapeutic measures which have been found to have some favourable effect upon the disease". This is all the more important because it deals with human leukemic patients and thus it is free from errors of extrapolation of data from experimental animals to humans. The presentations of Buchanan *et al.* on "specific action of azaserine" and that of Goldthwait on "Purine nucleotide biosynthesis and neoplasia" are excellent and may be quoted as models for the study of the mechanism of action of drugs at enzymic levels. An *in vitro* method of screening anti-leukemic drugs reported by Winzler may provide a useful tool, particularly since the number of anti-leukemic drugs is rapidly increasing.

One of the main obstacles to effective cancer chemotherapy is the occurrence of drug resistance, about which very little is known at present. In this context the papers by Nichols on "Resistance to Folic Acid Antagonists" and that by Hutchison on "Drug Resistant *S. faecalis*" are stimulating and welcome contributions. However, the best part of the volume comprises the proceedings of the round table discussion on treatment. In this Wintrobe has discussed the

criteria for evaluation of therapeutic responses. Farber, a pioneer in the field of chemotherapy of leukemia, has reviewed his experience with antifolics and Burchenal has reviewed the results of combination therapy of 6 mercaptopurine and azaserine. Hill and Gellhorn have presented their data on chemotherapeutic trials with corticoids and Damashek has reviewed his experiences with newer agents like TEM and Myleran. Clinical trials with newer antimetabolic substances analogous to colchicine are reviewed by Mieschlin.

This book will prove very useful not only to clinicians but also to persons who are interested in leukemia whether in the clinic or in the laboratory and could be recommended as a baseline study for all further work on this subject.

V. R. K.

**The Species Problem.** Edited by Ernst Mayr. (American Association for the Advancement of Science), 1957. Pp. v + 1-395. Price \$ 8.75.

It is at once extremely interesting and challenging that in spite of two centuries of analysis, the "Species" remains a problem. It could almost be said that of all problems in biology here is one that has continually defied solution. Several attempts have been made in the past to find a solution, but every time the "Species Problem" has raised its head with greater vigour and persistence, with the result that in the middle of the 20th century, we are still debating it. •

There is however one definite improvement in position. We seem to understand the problem better today than we ever did before. We also understand the difficulties that are in the way of its solution, more clearly. And that is one definite forward step. We realize also that hasty and dogmatic assertions are not likely to contribute to its solution. That is another forward step too.

That is because the almost limitless diversity of plant and animal life may not permit the application of one single standard yardstick to measure the species concept. What are the criteria that one has to employ for the determination of a species? Are these criteria of universal application to all animals and plants? If they are not, is there not something wrong with the concept of species itself, as we now understand it? Shall we modify it in some way so we can make it applicable to all organisms? These are some of the questions raised (but not necessarily answered) at the symposium of the A.A.A.S. in 1955. Perhaps for the

first time, students of varied disciplines in biology have come together to discuss it. For, 30 years ago, who would have thought that physiologists, embryologists and geneticists would sit together to discuss the problem which was regarded as the exclusive preserve of the systematist, with occasional permission for a morphologist to enter briefly?

For it is now recognized that the species problem is a universal problem impinging on every aspect of biological thought. You may define it as you like, you may push it afar or draw it near but its presence is ubiquitous and pervasive.

Nine papers were presented at the Symposium, Ernst Mayr contributing two. Mayr was eminently fitted for the task of co-ordinating the discussions as its Chairman. His analysis of speciation among birds is among the lasting contributions to biological thought of this century. He was therefore able to present not only different concepts and definitions of species as he does in his first essay, but also the difficulties that beset the student of species, in his last contribution. Carson, from the geneticist's view-point, looks upon species as a system of recombining genes,—a gene pool,—from which continually, smaller units of recombination, with varying degrees of isolation, are given off, resulting in different levels of integration.

Verne Grant's analysis is from the view-point of a field botanist. He recognizes a continuous and gradual process of evolution from individual to population, from population to race and race to species. The extensive occurrence of asexual means of propagation among plants often nullifies this process but is more than made up by other advantages like hybridization, which occurs far more freely among plants than among animals, and which is probably the largest single factor responsible for plant speciation. The two striking examples chosen by Brooks for his analysis of speciation in fresh-water animals,—the crustacean *Daphnia* and the whitefish *Coregonus*,—illustrate the amazing variations that emerge from the same genotype and reflect "the ability of the genotype to prosecute successful development over the wide range of environmental conditions occurring in the fresh-waters that these animals inhabit". An added difficulty is the occurrence of several variable species of both genera in the same environment resulting in extensive hybrid formation and introgression. The species problem in these two organisms and possibly in other fresh-water animals is therefore

of a quite different nature. When we come to fossil species, however, we notice there is much controversy and even confusion. Incompleteness of fossil records, and an almost entire reliance on morphological traits of limited category, contributes to this difficulty and it is at once recognized that the palæontologist works in a rather circumscribed area. Sonneborn's "masterly synthesis" deals with problems of speciation in the Protozoa, particularly among ciliates, whose peculiar population structure is perhaps responsible for many aspects of their reproductive patterns. He has dealt with the whole problem of variation in these organisms, the inadequacy of morphological and physiological criteria for determining species. With the newer knowledge about serology, host-parasite relationships and reproductive phenomena, it can now be seen how delicate the species is balanced in the Protozoa. Moore relates the astonishing variations in embryological adaptations in closely related organisms often regarded as species but with geographical isolation, and makes a plea for an adequate recognition of environmental factors on development in any delineation of species. Prosser brings in evidence of many physiological characters, especially stress tests, that can provide evidence of variation in natural populations. This is as yet a new discipline and further information about physiological variation is necessary; but analysis of cellular and enzymatic processes and their variations in different organisms would undoubtedly throw a great deal of light on the problem of species at this level.

As Mayr says, "it would be too much to expect the Symposium to solve the species problem", but there is no doubt it has made a solid contribution to its understanding.

B. R. SESHACHAR.

**General Microbiology.** By R. Y. Stanier, M. Doudoroff and E. A. Adelberg. (Macmillan & Co., Ltd., London), 1958. Pp. xxii + 682. Price 50 sh.

Last two decades have witnessed rapid advances in our knowledge of biology of micro-organisms and in regard to the elucidation of their chemical activities that it has become impossible for any individual to canvass completely and digest adequately all the information available even in one specialised field of microbiology. The task becomes all the more difficult to a beginner in the subject as he is unable to interpret properly the reviews, research publications and monographs intended for readers at an advanced level with the result he is left

with materials difficult to digest. This book, written by three experienced professors in the subject, is an answer to his quest for a well-organised text-book in *General Microbiology*. What is more, the book covers almost the entire field of the subject and provides not only the necessary "Biological Background" for a better "comprehension of the elements of microbiology" but conveys succinctly a modern synthesis of microbiological knowledge in a fascinating way to make the text one of absorbing interest.

The book is appropriately divided into three parts, the first two parts corresponding roughly with two major phases of microbiology, viz., "The Properties of Micro-organisms", and "The Ecology of Micro-organisms". The third part is devoted rightly to a review of the principles of cellular biology which would enable the student not only to have a better grasp of the material presented in the other two parts but also for a proper appreciation of biological sciences dealing on such important topics as matter and origin of life, energy and life, natural selection, genetics, taxonomic categories, classification, etc., all of which have been summarised in an admirable way for the reader. Another feature of this book is that its running text material is not disturbed with references and the new student has not to, in consequence, encounter any formidable bibliographies at the end of every chapter. A judicious selection of a score of books with critical appreciation thereof is however given for those interested in covering wider aspects of the field.

Part I consists of 19 chapters, and Part II consists of next 11 chapters and all these together cover adequately the major groups of micro-organisms, their ecology and interrelationships. Important topics as "Principles of Chemotherapy", "The Dynamics of Disease in Populations", and "The Exploitation of Micro-organisms by Man" have been dealt with separately. Every chapter is preceded with a table of contents pertaining to that chapter and this should prove of immense help to a beginner to locate easily any text material.

The type used is large and clear and is arranged in a fashion which is inviting and conducive to reading. Names of micro-organisms and all new and/or technical words are italicised. The style of writing is simple, clear and expressive. The volume is profusely illustrated with excellent graphs, photographs, photomicrographs, electron micrographs and diagrams which help fully explain the principles and practice of microbiology. In short, the book

serves the purpose intended, is moderately priced, and should find wide acceptance as a teaching tool for the teachers and a valuable text-book for the students of microbiology and as such is warmly recommended. J. V. B.

**Lectures in Immunochemistry.** By Michael Heidelberger. (Academic Press, New York), 1956. Pp. ix + 150. Price \$ 4.00.

This volume consists of nine lectures delivered by the author during the last ten years, six of which were given at the University of Tokyo, Japan, in 1955.

The first lecture, *Immunochemistry—Past, Present and Future*—deals with the historic development of immunochemistry under the impact of the introduction of quantitative micro-methods on the chemistry of antigens and antibodies. The second lecture discusses the nature of the antigens and the antibodies and the theories of antibody formation. The development of quantitative analytical methods, utilising the nitrogen-free antigen and partly purified antibody as applicable to precipitin reactions and the kinetics of these reactions are lucidly presented in the third lecture. Bacterial agglutination and the consequences of quantitative studies on the precipitin and agglutinin reactions; relations between constitution and immunological specificity and complement and immune hemolysis are the titles of the other three lectures in this series.

These six lectures present to the readers a comprehensive account of Immunochemistry, a branch of science still in a highly speculative and experimental stage.

The close relation between the theoretical and the practical, as exemplified by the application of the fundamental principles of the science of immunity to public health, and persistence of antibodies in man after immunization and some facets of precipitin reaction form the concluding chapters of this instructive booklet.

M. SIRSI.

**An Atlas of Air-borne Pollen Grains.** By H. A. Hyde and K. F. Adams. (Macmillan & Co., Ltd., London), 1958. Pp. xvi + 110. Price 36 sh.

Palynology is one of the modern integrative sciences that has its ramification in such diverse fields as taxonomy, climatology, archæology, medicine, phytopathology, etc. Some very valuable publications on the subject have appeared during recent years but regional surveys, especially illustrated ones like the *Atlas* in question, will always be most welcome.

This *Atlas* is an excellent little book based

on investigations that extended over a period of 15 years and that were intended primarily "to form the background to the study of inhalant allergy", the authors being associated with Asthma and Allergy Research Unit of St. David's Hospital, Cardiff. It comprises 112 pages of fine art paper carrying about 190, unnumbered black and white micro-photographs of pollen belonging to 92 species caught from the air in Great Britain at 15 different collecting stations. Most of these species were identified by the authors from the vegetation growing in the neighbourhood of collecting stations. While majority of the species identified are obviously anemophilous, some 30 of them are such as are usually regarded entomophilous.

After a brief half-a-page Preface, there follows a three-page Introduction in which the authors state their objective and give some details on: technical methods; the morphology of the pollen grain; measurement; and contents and arrangement. This is followed by a dichotomous "key to air-borne pollen grains". As a result of a "master key", six types of grains are recognised—compound, vesiculate, inaperturate, porate, colpate and colpurate. These are further sorted out into genera. This is perhaps the most useful part of the text.

The main part of the book is a "descriptive catalogue of air-borne pollen grains", that is, in two parts. Part I is devoted to angiosperms, and Part II to gymnosperms represented only by the Coniferæ. In Part I, the arrangement is alphabetical by families and genera respectively, while in Part II, it is alphabetical by genera.

The plan of treatment of material is the same in all cases. For pollen of every species there is a brief enumeration of salient features concerning exine, furrows, polar fields, pores, intine, etc., and two (occasionally one or more) microphotographs, one showing one or more pollen grains in optical section and the other the same in surface view. All the photographs have been taken at a magnification of 800 diameter. Most of them are exceptionally clear and collate well with the description.

At the end there is a brief glossary of "morphological terms" and "conventional terms" followed by a select bibliography of a dozen references and a brief index.

The reviewer is somewhat disappointed at the scant attention paid to the text. The title of the book demands that some information should have been given about the methods used in trapping air-borne pollen, the changes that the



pollen undergo during their flight, and the difficulties encountered in handling them in laboratory. As it is, the title of the book appears to be somewhat inappropriate as here the emphasis is on air-borne pollen while in the text and illustrations the emphasis is on fresh pollen, of course obtained mostly from anemophilous plants.

Despite these shortcomings the *Atlas* is a valuable addition to the current growing literature on palynology. Both the authors and the publishers deserve our congratulations for the excellent photographs and perfect reproduction.

V. PURI.

#### Books Received

*Solid State Physics. (Advances in Research and Applications)*, Vol. IV. Edited by Frederic Seitz and David Turnbull. (Academic Press, Inc.; India: Asia Publishing House, Bombay-1), 1957. Pp. xiv + 540. Price \$ 12.00.

*Rockets, Missiles and Space Travel.* By Willy Ley. (Chapman & Hall, London W. C. 2; Asia Publishing House, Bombay-1), 1957, Pp. xv + 528. Price 50 sh.

*Electronic Measuring Instruments.* Second Edition. By E. H. W. Banner. (Chapman & Hall, London W. C. 2; Asia Publishing House, Bombay-1), 1958. Pp. xvi + 496. Price 56 sh.

*Organic Electrode Processes.* By Milton J. Allen. (Chapman & Hall, London W. C. 2; Asia Publishing House, Bombay-1), 1958. Pp. xiv + 174. Price 32 sh.

*Disinfectants, Their Values and Uses.* By W. E. Finch. (Chapman & Hall, London W. C. 2; Asia Publishing House, Bombay-1), 1958. Pp. 188. Price 30 sh.

*Satellites and Spaceflight.* By Eric Burgess. (Chapman & Hall, London W. C. 2; Asia Publishing House, Bombay-1), 1958. Pp. vii + 159. Price 21 sh.

## SCIENCE NOTES AND NEWS

### Two New Improvements in Electromagnetic Weighing

Mr. D. N. D. Kaikiny of the Craftsman Electronic Corporation (Private), Ltd., Bombay-10, writes as follows: An electrobalance for micro-analytical weighing is a necessary adjunct in any well-equipped research laboratory. Its application is especially useful with tests undertaken by means of a microscope, microtome, spectrograph, spectrophotometer, colorimeter, polarograph, etc., involving microgram weighing. The passing of a measured current through the coil of a d'Arsonval movement to counterbalance the load applied to the pointer, is the most common method.

However, the new improvement of operating the electrobalance on a 6 volts dry battery is distinct progress, because it eliminates (i) the Mains power fluctuations, and (ii) the use of special bulb which hinders operation by breakdown due to various causes. These special bulbs are hard to obtain in the market. The 6 volts dry battery method offers most simplified operation giving readings in a second or two. Secondly, the provision to remove the weighing compartment to a considerable distance enables operation in inaccessible places, such as hot radiation cells, dry boxes, etc.

These improvements will undoubtedly lessen the chores of the research worker.

### Super-High Pressures—Age-old Dream Comes True

The physics of super-high pressures opens out a large vista of research providing good promise of unexpected results in various branches of science. For example, it has been determined that solid materials obtain new properties when placed in a liquid compressed to several tens of thousands of atmospheres.

The combination of high pressures and temperatures made it possible for the old dream of scientists to come true. It is known that diamond and graphite consist of the same atoms of carbon having only a different arrangement. Many attempts were made to change the crystal lattice of graphite and convert it into diamond. It became possible to develop an enormous pressure of 427 thousand atmospheres during one test but only at room temperature and the goal of obtaining diamond was not reached. It turned out that small artificial diamonds could be obtained at a temperature of nearly 3,000° and at a pressure of 100,000 atmospheres. The importance of this discovery is exceptionally great though the cost of such diamonds is higher than that of natural ones.

The combination of high pressures and temperatures made it possible for scientists to obtain also very hard crystals by combining boron with nitrogen thereby producing borazon. The

hardness of the latter exceeds that of diamond and it is so great that borazon leaves scratches even on diamond which is the hardest natural material. It should be noted that unlike diamond, borazon can be used with success at temperatures upto  $2,500^{\circ}\text{C}$ .—*Laboratory of Physics of Super-High Pressures, USSR Academy of Sciences.*

### Satellite Anniversary

October 4, 1958 marks the anniversary of the launching of the first artificial earth satellite. The launching of the Sputnik I on October 4, 1957 marked the beginning of the conquest of cosmic space by man. The first satellite made 1,400 circuits round the earth, covering about 60 million kilometres in the course of 92 days. Sputnik II, which carried the dog Laika, existed for 161 days and covered more than 100 million kilometres making 2,370 circuits round the earth. Sputnik III, weighing 1,327 kg., and its carrier rocket are now circling our planet. It has already covered nearly 100 million kilometres. The initial period of about 106 minutes has declined by 2.1 minutes and is now 103.85 minutes. Accordingly, the apogee has decreased by 190 km. and it is now 1,690 km. The wireless transmitter, fed from a solar semi-conductor battery, has been reliably functioning for the past  $4\frac{1}{2}$  months. The automatic control of all scientific and measuring instruments is effected by devices based exclusively on semi-conductors of which several thousand elements had been installed in it. The information received with the help of the Sputniks throws new light on many aspects of the physics of the troposphere.

### Transuranic Elements—Their Place in the Periodic Table

The ten new elements ranging from neptunium ( $Z=93$ ) to nobelium ( $Z=102$ ), constitute a new group analogous in electronic structure to the rare earth elements. This implies that the 5f-electron shell is progressively filled. It would have its maximum complement of fourteen electrons in the hitherto undiscovered element of atomic number 103. This electron assignment is based, first, on the analysis of the emission spectra of some of the elements in question. Secondly, the magnetic properties are analogous to those of the rare earth elements. Thirdly, crystal structure determination of many solid compounds of the new elements have enabled values of ionic radii to be assigned. These show a decrease as the series is ascended, which parallel closely the well-known lanthanide con-

traction in the rare earth series. Absorption spectra of the transuranic elements also show characteristic sharp absorption bands, associated with transitions within the shielded 5f-level.

Chemically, the new elements differ from the rare earths in that, instead of having predominantly a valency of three, higher values are found. This is associated with the great ease with which the electrons are lost.

The maximum valency of 6 is most stable in uranium, but it is also observed in neptunium, plutonium and americium. Curium and berkelium, the next two elements, have valencies of 4, but, so far as is known, the higher members of the series are restricted to a valency of 3. (Prof. H. J. Emeleus in his Presidential Address to Section B of the British Association Meeting in Glasgow, *Nature*, 182, p. 579.)

### A New Stage in the Development of Astronomy

At a Meeting of the International Astronomical Congress in Moscow on August 14, Dr. Lallemand (France) reported that French scientists had succeeded in obtaining the spectra of remote galaxies which had hitherto been beyond the reach of ordinary astronomical instruments. They had used instruments of a new type—electron-optical converters—which greatly amplified the brightness of heavenly bodies.

The rays from remote galaxies fall on a highly sensitive cathode in the instrument and cause it to emit an electron beam. After passing through an elaborate system of amplifiers, the beam is reproduced on a luminiscent screen, on which a greatly amplified image of the galaxy appears. Electron-optical conversion is 50 to 100 times more sensitive than ordinary photography.

The new instrument has also proved effective in photographing the Sun and the use of the combined method has turned out to be far superior to ordinary photography, particularly in recording rapid changes in the Sun's corona. The time of the exposure can be reduced by this method to between one-fifth and one-tenth of what was previously required and there was no blurring in the photographs.

### Important Discovery on Nucleons

The results of experiments with the proton synchrotron of the Joint Nuclear Research Institute in the town of Dubna, near Moscow, where a technique has been developed for obtaining purified beams of anti-protons, prove that there are two types of nucleonic collisions—peripheral and central. During peripheral collisions the nucleons retain their individuality, i.e., the

proton remains a proton and the neutron remains a neutron. It is possible that in the central collisions protons are transformed into neutrons and *vice versa*. In both types of collisions light particles—mesons—are formed; when the collisions are central their number increases many times over.

The important discovery leads to the conclusion that elementary nuclear particles have two regions—a periphery or a kind of envelope, and a core. This was announced by Academician Vladimir Wexler at the Atoms for Peace Conference in Geneva.

#### Potassium Chloride from Sea Bitterns

At the Central Salt Research Institute at Bhavnagar, a simple and economic process has been developed for the recovery of potassium chloride from sea bitterns, which are now largely allowed to go waste. Bittern is the name given to the oily liquid which remains after the extraction of salt from sea-water.

India's annual production of sea salt is about 3 million tons. The bitterns let to waste after the recovery of sodium chloride have been found to contain appreciable quantities of potassium chloride and it is estimated that as much as 80 to 85 thousand tons of potassium chloride could be recovered from them.

The bitterns are concentrated to the required degree by solar evaporation and treated with lime slurry to precipitate the magnesium sulphate. The supernatant liquor containing mostly potassium chloride and chlorides of sodium and calcium is further concentrated until most of the sodium chloride and potassium chloride crystallise out. From the product, so obtained, potassium chloride is separated by further crystallisation.

#### Kit for Detection of Ghee Adulteration

The Central Food Technological Research Institute, Mysore, has devised a cheap and simple Ghee Testing Kit which makes detection of ghee adulteration easy.

The kit consists of a marked test-tube, a sealed capsule containing a little acid, a sealed capillary containing some other chemicals, and a cutter. The testing itself is a simple process and can be easily understood and mastered. The main attraction of the kit, however, con-

sists in its inexpensiveness. The entire kit (including chemicals) costs about 8 nP., and the recurring cost of each test does not exceed 3 nP.

#### Fourth Congress on Theoretical and Applied Mechanics

The above Congress will be held at the Bengal Engineering College, Howrah (Calcutta), from December 28-31, 1958, under the Presidentship of Dr. S. R. Sen Gupta.

Research papers to the Congress will cover the following subjects:

1. Elasticity-plasticity-rheology; 2. Fluid mechanics (Aerodynamics-hydrodynamics);
3. Mechanics of solids (Ballistics-vibrations-friction-lubrication); 4. Statistical mechanics—thermodynamics—heat transfer; 5. Mathematics of physics and mechanics-methods of computation; (6) Experimental techniques.

Further information regarding the Congress can be had from the Secretary-Treasurer (Dr. B. R. Seth), Indian Institute of Technology, Kharagpur.

#### IX International Botanical Congress

The Ninth International Botanical Congress is to be held in Montreal, Canada, in August 19-29, 1959.

Dr. T. S. Sadasivan of the University of Madras has been invited to act as a Vice-Chairman of the Phytopathology Section. Dr. T. V. Desikachary has been invited to organize a symposium on "Electron Microscopy and Algal Structures".

#### Birbal Sahni Institute of Palaeobotany, Lucknow

The Eleventh Annual Scientific Meeting of the Palaeobotanical Society will be held at the Institute's premises on the 17th and the 18th of January 1959. The programme chalked out includes lectures, reading of papers and discussions. Palaeobotanists from all over India are expected to participate.

#### Award of Research Degree

Poona University has awarded the Ph.D. Degree in Chemistry to Shri Vasant Ranganath Keskar for his thesis "Studies in Thermal Polymerization of Dehydrated Castor Oil".

---

1015-58. Printed at The Bangalore Press, Bangalore City, by C. Vasudeva Rao, Superintendent, and Published by A. V. Telang, M.A., for the Current Science Association, Bangalore.

All material intended for publication and books for review should be addressed to the Editor, *Current Science*, Raman Research Institute, Bangalore-6.

Business correspondence, remittances, subscriptions, advertisements, exchange journals, etc., should be addressed to the Manager, Current Science Association, Raman Research Institute, Bangalore-6.

#### ANNUAL SUBSCRIPTION

India: Rs. 12-00. Foreign: £ 1-4-0. \$ 4-00

## SCIENCE IN EASTERN EUROPE: II

SIR C. V. RAMAN

### 6. BUCHAREST

LEAVING Budapest in the forenoon of the 28th of June, we arrived at Bucharest early next morning and remained there till late at night on the 7th of July. During our stay we were the guests of the Rumanian Academy of Sciences and the Rumanian Institute for Cultural Relations with Foreign Lands. These two organisations took it upon themselves to make our sojourn in Rumania a most interesting experience. The enthusiasm and cordiality with which we were received and entertained cannot easily be described.

Three days, namely, the 2nd, 3rd and 4th of July were devoted to the preparation and delivery of a course of three lectures on the "Physics of the Diamond". The hall of the Academy where the lectures were delivered was filled to capacity on all the three evenings. In giving these lectures, I had the assistance of Dr. Gavrilă, a young theoretical physicist who spoke and understood English very well. The main points of each lecture were discussed with him and written out in advance and he could therefore translate my lecture as delivered orally in a perfect manner. The results were satisfactory both to myself and to the audience.

A notable recent development in Rumania is an Institute of Atomic Physics which has been built a few miles away from Bucharest and is accommodated in a group of buildings, the two largest of which contain respectively an atomic reactor and a cyclotron with their controls and accessories. As the Director of the Institute, Academician Hulubei, was away in Geneva at the time of my visit, I was shown round the Institute by the members of the staff. The latter includes Academician Țițeica who is the leader of an active school of theoretical physics. I also paid a visit to the Institute of General Phy-

sics at Bucharest of which Academician Bădărău is the Director. I was shown round the various laboratories in which I found much valuable work in progress in diverse fields and had the pleasure of learning about the details of that work individually from Prof. Bădărău's colleagues. I was also much interested in the arrangements made to give a preparatory course of experimental work in nuclear physics to the University students.

During our stay at Bucharest I had the pleasure of meeting the Prime Minister of Rumania at his office and had a long and interesting conversation with him. The Prime Minister gave me a detailed account of the progress being made by Rumania in the economic, educational and scientific spheres and expressed with sincerity and emphasis his desire that Rumania should come into much closer relationships with India in various fields of activity for their mutual benefit.

Two days were devoted to a tour by motor from Bucharest to Ploesti up the valley of the river Prahova to the mountains and back. On our way we passed through the region where the famous Rumanian oil wells and the oil refineries are located. The terminus of our tour was at Sinaia, a well-known hill resort at which we made a short stay. From the verandahs of our lodge we could see the mountains encompassing Sinaia. We motored to a hotel perched up on the heights and on our way back visited the Peleş Castle, formerly a royal residence and now a public museum which has lovely gardens and terraces with beautiful views on every side.

That Rumania has an active scientific life and an intellectual climate favourable to achievement was very evident. An extensive scientific literature exists in the language of the country, merely as a sample of which

I may mention a book on the physics of the solid state written by the young physicist Sergiescu and a book on the acoustics of the violin by Professor Bianu, copies of which the authors were good enough to present to me.

We had a wonderful send-off from Bucharest. At the station we were handed two beautifully bound albums containing photographs of our visits respectively to the Institute of Atomic Physics and the Institute of General Physics.

#### 7. BELGRADE

Yugoslavia lies on the railway route between Rumania and Italy, and in our travel programme which had been arranged in advance, two weeks had been set apart for a journey through that country with a stop-off at each of its three chief cities, *viz.*, Belgrade, Zagreb and Ljubljana. The holiday season had however already begun and I was under the impression that the time chosen for the visit to Yugoslavia was not a suitable one for making any useful contacts with its scientific men. This anticipation, however, turned out to be false. Nawab Ali Yavar Jung who is the Ambassador of India at Belgrade is an old friend of mine. He welcomed us on arrival and told us that he had taken the initiative in arranging a programme for our stay at Belgrade. This, in the event, proved to be highly interesting and fruitful.

Belgrade is the capital of Serbia and has been the scene of many conflicts in its past history. It is now also the capital of the Federal Republic of Yugoslavia. The city is situated near the confluence of the Sava and the Danube which join here to form a single mighty stream. Standing on the ramparts of the ancient fortress of Belgrade, one sees an impressive panorama over the rivers and the neighbouring city of Zemun. Very appropriately also, in the Citadel of Belgrade have been set up the memorials of the recent conflict in which the partizans under the leadership of Marshal Tito successfully

defended their country against the armies of Hitler.

Professor Milojević of the Physical Institute of the University of Belgrade had arranged for a lecture by me on the 9th of July following the day of our arrival. Professor Savić took the Chair and I expounded as briefly and as clearly as possible the ideas regarding crystal physics which had emerged from the Bangalore investigations. On each of the three following days (10th, 11th and 12th of July) I visited the Institute of Nuclear Sciences which had been set up by the Federal Government. The Institute is located at Vincha about fifteen kilometres away from Belgrade and the motor road leading to it took us through some lovely countryside, and Vincha itself is most picturesquely situated. I was warmly welcomed at the Institute by Director Popović who is in charge of the administration and by Professor Savić who is in charge of the scientific activities. Great progress had been made in building up and equipping the Institute and further developments were in full swing. I found many young scientists at work and much activity in the laboratories.

On the 11th of July, I gave a lecture at the Vincha Institute in which I expounded my ideas regarding the structure of diamond and the explanation of its properties. Prof. Savić presided at the lecture and led the discussion which followed it. The rest of my time at the Institute was taken up in visiting its various departments, viewing the equipment which had been set up or was being set up and discussing the investigations in progress with the workers in its laboratories. In the evening of the 12th of July, I visited the Serbian Academy at Belgrade of which Professor Belić and Professor Kšanin are respectively the President and Vice-President. The Mathematical Institute of the Academy which I inspected is an active organisation and has a fine library. The publications of the Institute are regarded with respect in mathematical circles everywhere.

Our hosts of the Institute and the Academy did their very best to give us a happy time. On the afternoon of the 11th of July, there was an excursion to the hill-top of Avala, a few miles out of Belgrade, on which a highly impressive monument to the

the Danube and saw several of its beauty-spots.

#### 8. ZAGREB

As had been planned earlier, we were at Zagreb for three full days, arriving on Monday evening, the 14th of July and leaving

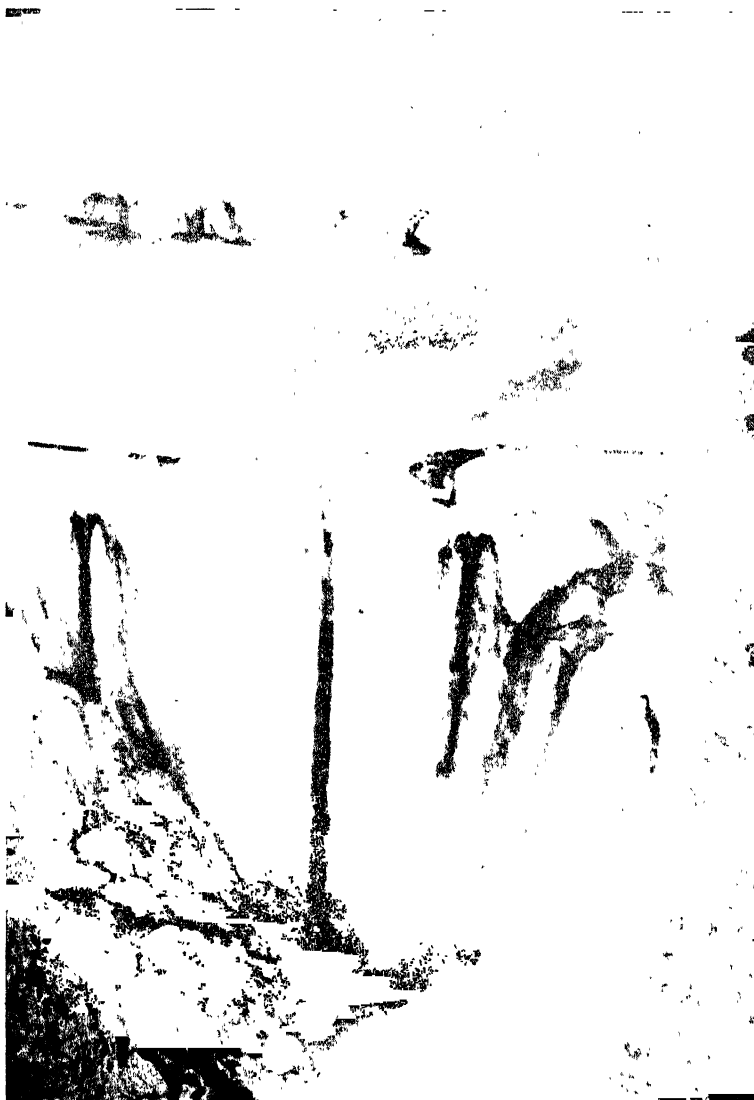

FIG. 3. The Plitvice lakes, Yugoslavia

Unknown Warrior stands. Extensive views are to be seen on all sides from the monument. On Sunday the 13th of July, we were taken on an all-day motor tour through the Serbian landscape. We visited the valley of

for Ljubljana on the forenoon of Friday the 18th. The holiday season was in full swing and we travelled in a train which was very crowded, but the special consideration which was given to us by the railway staff saved

us from discomfort. We were met at the station by Dr. S. Asperger and taken to our hotel.

Croatia is one of the several Republics which have federated to form Yugoslavia. It includes a great part of the coast-line of that country from Fiume in the north to Kotor in the south, as also an immense number of islands, great and small, in the Adriatic Sea. Zagreb is the capital of Croatia, and is a large city. The river Sava runs a few miles south of it while immediately to the north of the city are some high hills which help to make Zagreb and its surroundings very picturesque.

Local patriotism runs strong in Yugoslavia, and since a great new Institute of Nuclear Physics is going up at Belgrade, it was only to be expected that Zagreb would not lag behind. Indeed, our visit to Zagreb, brief though it was, owed its great interest to us by reason of that very circumstance. On the rising ground between the city and the mountains a great new Institute had been set up named quite appropriately as the Boscovitch Institute after the great pioneer of an earlier age in the field of atomic physics. The Institute is by no means a duplication of the effort which is building the organization at Belgrade. The scientific ideology animating the Boscovitch Institute is indeed different, embracing a wider range of scientific topics. Nuclear physics was of course represented and indeed showed every sign of being an active field of interest at Zagreb. The fitting up of a laboratory containing a large cyclotron was in an advanced state of progress. Prof. Paić also showed me the equipment that he had set up for investigating the behaviour of atomic nuclei under neutron bombardment. During my visit to the chemical laboratory of the Institute, I was much impressed by the work being done by Dr. Asperger on the detection of traces of mercury in the atmosphere by its effect upon the rate of chemical reactions. This is a subject of practical importance, since

Yugoslavia is an important producer of mercury from its naturally occurring minerals.

An interesting function at which I was present was the final examination for the Doctor's Degree in Physics of two young aspirants for that distinction. I sat alongside of the Board of three Examiners which consisted of three professors of the Zagreb University. In view of my presence at the examination, the candidates were asked to give the oral presentation of their theses in the English language. That they could do so and very well indeed was not surprising, since the experimental work of one candidate was done at Cambridge in England and by the other at Rochester in U.S.A. The *viva voce* examination which followed the oral presentation of the theses was very searching, but the candidates showed up very well. I felt that the system followed at Zagreb of having only internal examiners for the doctorate was an admirable one which was worthy of being followed elsewhere.

Apart from the activities referred to above, our three days at Zagreb were fully occupied. On Tuesday the 15th of July, I spoke on the problems of crystal physics at a colloquium at which Dr. Supek and his colleagues in theoretical physics were present. The discussions with him on this and other topics were continued later in the day when he drove us up to a mountain lodge some miles behind Zagreb where we spent a few happy hours wandering through the woods. The next day, Prof. Paić and Mrs. Paić took us out on an all-day motor excursion in the course of which we visited the medieval town of Karlovie and thence proceeded to the famous national park containing the Plitvice lakes. Here we spent the rest of the day exploring the lakes, returning to Zagreb late in the evening, tired but happy. To describe the Plitvice lakes adequately and convey an impression of their transcendental beauty would need a whole article to itself. We can only reproduce here a photograph of a very small part

of the region including the waterfalls characteristic of the area.

On the third day, the 17th of July, we were entertained by Prof. Paič and Mrs. Paič

later parts of the tour may be of some interest to the readers of *Current Science*. The railway journey from Zagreb to Ljubljana is not a long one. It took us through the

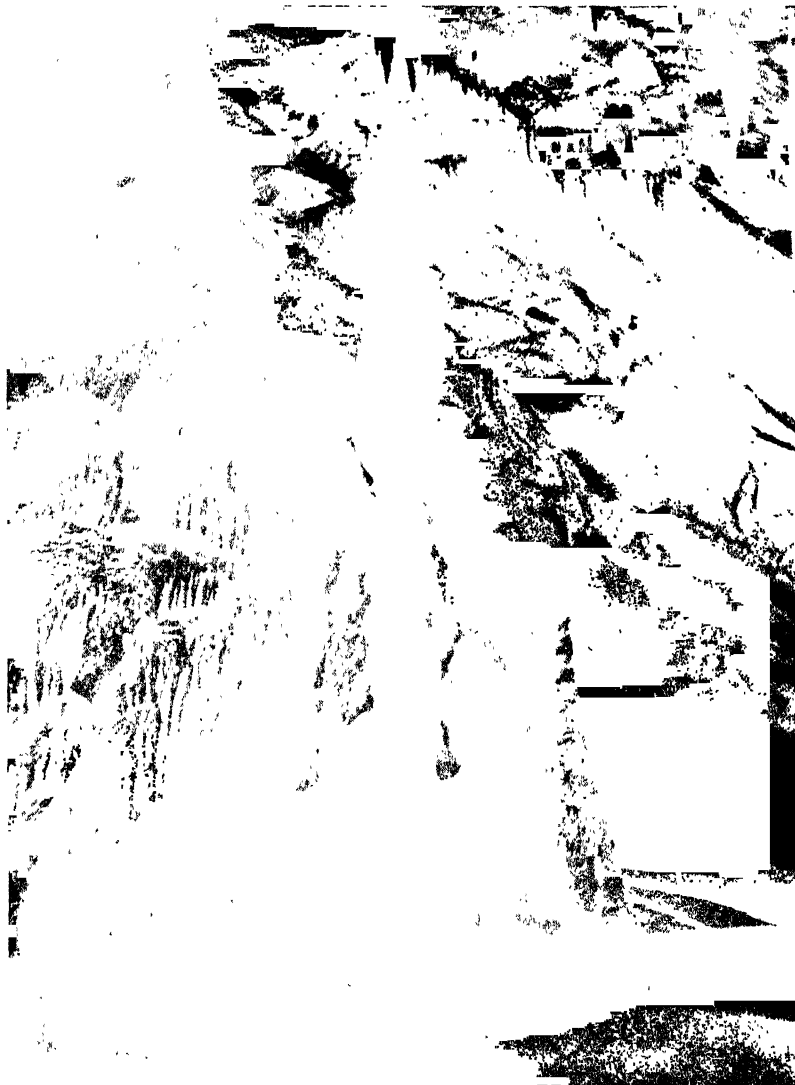

FIG. 4. Near the entrance to Posthumia caves

at their home. They bid us an affectionate farewell next morning at the station when we left for Ljubljana.

#### 9. THE REST OF THE TOUR

My scientific activities ceased when we left Zagreb. But a brief reference to the

beautiful valleys and gorges which the river Sava has made for itself in flowing through Slovenia. Ljubljana itself is a charming town with a medieval castle on a hill, right at its centre and a great city park extending into the hills. The day after our



arrival, we drove up to the celebrated limestone caves at Posthumia which lies halfway between Ljubljana and Trieste. These caves run for several miles underground, and indeed one has to make a good part of the journey within them by electric trolley. The rest of the journey on foot through the cavernous interior takes us through a region of which the magnificence and fantastic character beggars all description. The photograph reproduced shows a region near the entrance to the caves. On Sunday, we undertook a motor tour to the region of the Julian Alps including the two lakes, Bled and

right at the foot of the mountains and has a sombre beauty of its own.

Leaving Ljubljana on the morning of the 21st, we travelled *via* Trieste and the coast of the Adriatic to Italy and Venice, reaching the latter city the same afternoon. We spent the next day at Venice visiting its palaces, the Lido and the lagoons. The next day, again, we toured through Venetia by motor, viewing its many beautiful villas with their Palladian architecture. Crossing the river Brenta by its celebrated wooden bridge, we went as far as Asolo before finding our way back to the Grand Canal of Venice and our hotel.



FIG. 3. Lake Bled and its island

Bohini which lie in that area. Lake Bled and its environs appear comparatively sophisticated. The picture reproduced shows the church on an island in the lake and the Julian Alps beyond. Lake Bohini which is much further west is not far from Triklav, the highest peak of the Julian Alps. It lies

The evening of the 24th of July found us back again at Innsbruck where we remained three days. Innsbruck is a convenient centre for visiting the surrounding regions in Austria, Italy and Germany. The opportunities thus open to us were fully utilised before we left finally to catch our steamer at Genoa.

## NOBEL PRIZE AWARDS FOR 1958

### PHYSICS

THE Nobel Prize for Physics has been awarded to the three Soviet physicists, Pavel A. Cherenkov, Ilya M. Frank and Igor E. Tamm, for the discovery and interpretation of what is known as the "Cherenkov Radiation". This is the visible radiation produced in a dispersive medium by charged particles which move with a velocity greater than that of light in that medium. Nearly 25 years ago, P. A. Cherenkov of the Physical Institute of the Academy of Sciences of U.S.S.R., Moscow, reported his discovery of "feeble visible radiation emitted by pure liquids under the action of fast electrons—beta particles of radioactive elements or Compton electrons liberated in liquids in the process of scattering by gamma-rays" (*Phys. Rev.*, 1937, 52, 378).

According to the theory of relativity a material particle cannot travel with a velocity  $v$  greater than  $c$ , the velocity of light. However, we know that in a dispersive medium of refractive index  $n$ , light waves travel with the phase velocity  $u = c/n < c$ . Also we know that hard cathode rays and Compton electrons produced by very hard gamma rays attain velocities in the range  $u < v < c$ . What happens in this velocity range?

For velocities below that of light in the medium the electron carries its own field with it and no energy is radiated. But for velocities above that of light in the medium, the electron leaves its field behind in the shape of a Mach cone. The field radiates in directions perpendicular to the surface of the cone, and because of the nature of dispersion, this radiation consists mainly of visible light. The radiated light is polarized so that the electric vector lies in the plane passing through the trajectory of the electron. This is the Cherenkov Radiation.

Frank and Tamm calculated the field of the Cherenkov electron and showed that (i) the field was zero everywhere outside the Mach cone and (ii) an electromagnetic field existed everywhere in the interior of the Mach cone.

To produce Cherenkov radiation it is best to use a thin resin plate on which the electrons impinge perpendicularly. Thus only a small portion of the Mach cone appears, and the emitted radiation fills a thin annular cone perpendicular to that portion. The exposed area on a photographic plate, placed behind the resin

plate, renders the annular trace of this cone visible.

It is interesting to note that because in quantum mechanics one is forced to decompose the electromagnetic field into its Fourier components from the very start, the quantum mechanics treatment of the Cherenkov effect leads directly to a representation of the field in which dispersion can be taken into account, and therefore the visible character of the Cherenkov effect is directly put in evidence.

One important application of the Cherenkov effect is the Cherenkov detector for high energy particles. The bursts of Cherenkov radiation emitted by high velocity particles passing through a dielectric medium may be detected by a photoelectric cell, followed by an electron multiplier, and thus give rise to signals recording the number of particles passing through the given dielectric object. The discovery of antiproton in 1955 at the University of California would have been difficult without the Cherenkov detector.

### CHEMISTRY

British scientist Dr. Frederick Sanger of Cambridge has been awarded the Nobel Prize for Chemistry for his work in determining the composition of the insulin molecule. Dr. Sanger worked for 12 years on this problem and found that there were 777 atoms in the insulin molecule. This is the first time the structure of any protein has been determined. As science learns more about protein molecules, it will know more about how disease attacks the body.

### MEDICINE

The winners of the Nobel Prize for medicine are the three American scientists Dr. George Wills Beadle, Professor of Biology at the California Institute of Technology in Pasadena; Dr. Edward L. Tatum of the Rockefeller Institute for Medical Research, New York; and Dr. Joshua Lederberg, Professor of Genetics at the University of Wisconsin.

Their work concerns the actual basis of heredity—the way in which characteristics are transmitted from one generation to another. Their technique has become one of the most important tools in the study of cell metabolism. Now widely used, it has given important results in various biological and medical problems.

## THERMONUCLEAR ENERGETICS

PROF. G. BABAT

*Director of Technical Sciences, U.S.S.R.*

**W**HEN the firing pin of a toy gun strikes the cap, a low crackle is heard—that is, a miniature explosion.

The stroke of the firing pin makes some of the molecules of the explosive move at a greater speed, and they collide with others. When the impulses are sufficiently strong the molecules break up and their atoms form new and more stable combinations. The molecules' change-over—the explosion—may be compared to the crumbling of a column of bricks due to an impulse. Such a column is a system which is mechanically stable only within certain limits. Where the jolt is sufficiently strong the bricks fall into a heap, which is a more stable system and which has a smaller margin of energy than the high column. What is stable only within certain limits and at a sufficiently strong impulse passes into a more stable state is called a metastable system. Metastable systems are storehouses of power.

Fulminate of mercury, out of which caps are made, is chemically metastable. There are many chemical metastable systems, such as a mixture of molecules of benzene and oxygen. Under the proper impulse (mechanical blow, heating, electric spark) the molecules change over during which energy is released.

Besides chemical and mechanical metastability, there is also nuclear metastability; the nuclei of uranium, thorium and plutonium are examples of it. Under the proper impulse these nuclei disintegrate, split up; the nuclear particles group themselves differently, forming new, smaller and more stable nuclei, and the surplus energy is released.

It is on the use of the energy released in the splitting up of uranium that nuclear energetics is based. Nuclear electric stations under construction in the Soviet Union are all uranium electric stations.

Hydrogen, which is a component part of all rivers, seas and oceans, is also a nuclear-metastable substance, and the nuclei of hydrogen are storehouses of energy. However, this energy cannot be released by fissure, as the nuclei of ordinary hydrogen—protons—do not lend themselves to further splitting, but the reverse, by the fusion of the nuclei, their synthesis. If there is a sufficiently strong jolt, under the proper conditions, four nuclei of ordinary hydrogen will fuse, producing a nucleus of helium.

When a brick column crumbles, the specific energy (energy per unit of mass) released thereby will be relatively little. Where chemical metastable systems change over the specific energy is many times greater. And even more energy is released during nuclear reactions. As much energy is released during the break-up of atomic nuclei in 1 g. of uranium as in the burning of 3 tons of coal. In the synthesis of helium from hydrogen, almost 20 times as much energy is released per gram of hydrogen as per gram of disintegrating uranium.

In reactions caused by the splitting of nuclei of uranium, various radioactive products are produced, and considerable difficulties arise in removing and preserving these "ashes" which emit dangerous ionizing radiations.

Hydrogen is used in thermonuclear processes.

There is much hydrogen on earth, many times more than uranium. Hydrogen is found in an easily available state, for which reason mastering the reaction of "burning hydrogen into helium" opens up boundless prospects for humanity.

However, there is one thing in the way of applying the energy contained in the nuclei of hydrogen for peaceful purposes.

To disturb the equilibrium of any metastable system and release the energy latent in that system some impulse has to be given, some initial expenditure of energy has to be made.

In order to pull down the brick column which we offered as an illustration of a mechanical metastable system, it is enough to strike the column with some heavy object—a hammer or a stone—at a velocity of but a few score metres a second, but to bring out a chemical metastable system from a state of rest greater concentrations of energy are required. For instance, to make molecules of benzene and oxygen change over into molecules of water and carbon dioxide gas, the molecules have to strike one another at a velocity of not less than several hundred metres a second.

And to excite nuclear reactions many times greater, initial specific energies are necessary.

Like the nuclei of all atoms, the nuclei of hydrogen carry a positive electrical charge; the nuclei are incredibly small in size, and when two equally charged hydrogen nuclei

approach one another closely colossal repelling forces arise between them. In order to make two nuclei of hydrogen collide they have to be imparted a velocity millions of times greater than the velocity which is sufficient to excite chemical reactions in the collision of molecules.

The movement of particles of matter can be accelerated by heating them. Temperature is, strictly speaking, one of the measures of velocity of the particles of matter: the higher the temperature, the faster the particles move. Raising the temperature is a thermal method of exciting reactions. At a temperature above 1,000° an immense number of chemical reactions take place.

Nuclear reactions too can be excited by heating; such reactions are called thermonuclear. However, they require temperatures millions of times higher than the temperatures of chemical reactions.

In the interior of the Sun and other stars, temperatures reach tens of millions of degrees, and it is such a temperature which produces the reaction resulting in the synthesis of helium from hydrogen. This reaction is the source of the heavenly bodies' energy.

In terrestrial conditions, a temperature of the order of millions of degrees cannot be produced to continue for a protracted time either in solid or liquid matter. In compact matter, pressures of millions of atmospheres arise under such temperatures. As the temperature rises the particles of matter break up and scatter on all sides in a thousand-millionth part of a second.

Everyone has had occasion to see red, blue or green lights in the show windows of shops or outside cinema theatres. Those are the lights of rarefied gases in glass tubes through which an electric current is passed. As a result of the action of the electric current, a mixture of electrons and atoms which have partially or completely lost their electrons; this mixture physicists call "plasma". In plasma, matter is in an extremely rarefied state, with a cubic metre of it weighing less than a pinhead. And it is in such plasma that electrons and atomic nuclei can gain the high speeds corresponding to the super-high temperatures.

In recent years, attempts have been made in many laboratories all over the world to produce astral temperatures by passing the most powerful electric currents possible through rarefied gas.

Using currents of millions of amperes, Soviet scientists have produced "astral matter" in terrestrial conditions. A tube made of insulating

material is equipped at both ends with electrodes to which high-voltage current is delivered from a large battery of condensers. Under the action of the electric forces, the charged particles—electrons and nuclei of the atoms—move at great speed inside the discharge tube from one electrode to the other. An electromagnetic field appears around the flux of charged particles, compressing the flux, as though insulating it from the surrounding medium.

The magnetic lines of forces produce a "heat-proof magnetic bottle". But how stable is it? How long can the blob of the super-incandescent plasma survive? Will there be enough time for thermonuclear reactions to take place in the magnetic bottle? In recent years, considerably more attention has been given to working out theoretically and experimentally magneto-electro-hydrodynamics—the science of the behaviour of plasma streams in electromagnetic fields.

As far back as 1950, Academicians A. D. Sakharov and I. E. Tamm suggested the first model of a magnetic thermonuclear reactor. This work was later carried on in the U.S.S.R. in a number of directions and today several groups of scientists and engineers are engaged in it. One of the groups, headed by Academicians L. A. Artsimovich and M. A. Leontovich, have succeeded in producing the emission of neutrons by heating rarefied deuterium to a temperature of more than a million degrees.

Suggestions have been made to form groups of hydrogen nuclei in a high vacuum instead of in a gas: to release a stream of hydrogen nuclei from a large surface and then concentrate the stream by means of electronic optics into a common centre, group them into a compact blob in which the fast-moving nuclei will collide and react.

Experiments are being conducted to produce thermonuclear reactions in the so-called annular electrodeless electric discharges. In these discharges, the charged particles move in a close circle like grains of dust in a whirlwind. The charged particles form in the discharge chamber something like a ring of smoke which experienced smokers know how to blow.

Electrodeless discharges have been known for a long time. Already, before World War II, the author of this article built outfits for investigating electrodeless discharges at capacities of several hundred kilowatts. Today electrodeless discharges are being studied intensively in connection with thermonuclear reactions.

Data have recently been published about the British Zeta outfit. It has a doughnut-shaped

discharge chamber, three metres in diameter and one metre thick. Permeating the chamber is an electromagnetic current produced by the winding through which a condenser battery is discharged with a margin of energy of up to 500 kilowatt seconds. The plasma cord forms a ring of fire in the discharge chamber. It is a secondary shorted winding, and the strength of the current in the curl of the ionized gas reaches 200,000 amperes and a temperature of 4,000,000 degrees.

In the United States an outfit known as the Sherwood has been designed, which also has a doughnut-shaped discharge chamber.

In all cases a strong magnetic field is produced around the plasma cord which compresses

the plasma. Where the currents are large, the electromagnetic pressure may reach thousands of atmospheres.

We cannot expect to see regular thermonuclear reactors manufactured in the next few years, but there can be no doubt that the problem will be eventually solved. It will be possible to use thermonuclear reactions only on a large scale, in large power installations. Dreams of nuclear-powered motor cars or motor cycles will evidently remain dreams. Nuclear energy will be transmitted and distributed by means of electric power, and the development of thermonuclear energetics will make for still greater flowering of electric power engineering and for more extensive electrification.

## OPTO-PHYSICAL MEASURING INSTRUMENT MADE BY VEB CARL ZEISS JENA FOR CHEMICAL INDUSTRIES

DR. W. NEBE, Jena

CHEMISTS in large industries, same as in laboratories, are continuously in search for methods by which to carry out analyses within the shortest possible time. Optical methods have come into the foreground and have been adopted for this purpose to a vast extent during the last 20 years. To the "classical"

spectral analysis of the visible and ultraviolet regions to the infrared region of the spectrum and the employment of photoelectric measuring methods in the province of photometry. For all these methods, modern types of instruments have been developed by VEB Carl Zeiss JENA and have become indispensable expedients for analytical chemistry.

In the province of the micro-molecular chemistry, schlieren-optical and interference methods are of late being introduced in conjunction with electrophoretical and diffusion tests. For the observation and photographic recording the Macro-Electrophoresis Instrument (Fig. 1) is equipped with the universally applicable Schlieren-Recording Instrument 80. In addition to the registration of interference curves as well as of the gradients of the refractive index, etc., in stratified media, this schlieren equipment is also available for the examination of currents, heat-conductivity, ultrasonics and mixing processes, etc., in gases and liquids, as well as for testing the homogeneity of glasses. By employing the Toepler Schlieren Method it will be possible in this case to perceive deviations of light up to 2 sec. The specific request for Schlieren Apparatus for aero-dynamical and other examinations led to the development of a *Schlieren-Recording Apparatus with a 300 mm. diameter of the object field.*

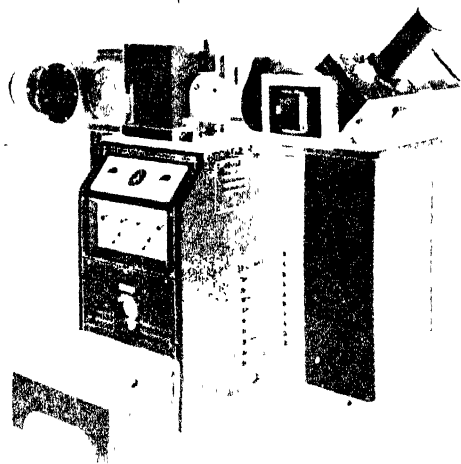

methods of refractometry, interferometry, polarimetry as well as of photometry and of the spectral analyses, new provinces have been added, especially such as the expansion of the

THE END OF A WAVE

R. PRASADA RAO AND E. C. LAFOND

INTRODUCTION

NUMEROUS beach erosion studies have been conducted by the students and teachers of Andhra University, Waltair, India, during recent years. The level, movement, texture, and composition of the sands have been investigated, as have the oceanographic factors that control the beaches, namely, tides, currents, and waves.<sup>1-4</sup> Of these factors, the waves exert the major influence in beach erosion. Waves in the sea are formed by strong winds. When once developed, they travel great distances as swell from the storm area. As they approach a sand beach they break due to the shallowing of the water and the receding water of previous waves. Some waves expend their energy in the surf zone. Most, however, end by rushing up the beach and then receding down its slope. This paper presents some findings of the nature of waves during such final periods of swash and backwash.

SWASH AND BACKWASH PERIODS

Observations of a great many waves on different types of beaches show that average time between swashes is related to both the average time between breaking waves and the slope of the beach. On steep sloping sections of the beach the wave period is nearly as long as the swash period. However, the swash period far exceeds the breaker period on gently sloping beaches (Table I), because of the greater

TABLE I

Beach Slope (Degrees)	Swash Period (Sec.)	Breaker Period (Sec.)	Difference Swash - Backwash (Sec.)
2.1	30.0	14.5	15.5
2.3	23.8	14.2	9.6
3.2	22.1	14.2	7.9
4.0	19.4	13.2	6.2
6.0	16.3	13.7	2.6
7.4	14.3	12.8	1.5
8.3	14.8	13.9	0.9
10.5	12.1	11.4	0.7
12.1	11.7	11.6	0.1

volume of water and slower movement of the backwash (and swash), and because there is less loss of water by percolation. This backwash overrides and neutralizes some of the advancing waves.<sup>5</sup>

SWASH AND BACKWASH SPEEDS

To measure the speeds of the swash and backwash a simplified manometer type flow

meter was developed (see Fig. 1). It consists of two right angle glass tubes mounted on a frame. One open end of a right-angled glass tube was held towards the advancing water in

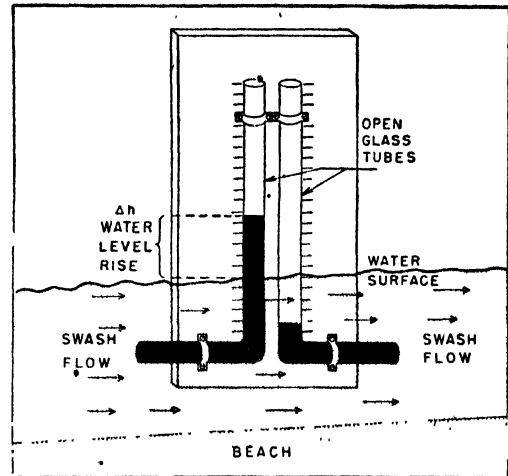

FIG. 1. Manometer type flow meter used to determine speed of swash and backwash.

the swash and the other towards the backwash. The height to which the water rose in the vertical portion of the tube over that of the surrounding water, provided a measure of the water speed.

Disregarding the frictional and orifice loss, the height that the water rises in the tube is

$$\Delta h = \frac{U^2}{2g}, \quad (1)$$

where U is the velocity of the water and g is the acceleration of gravity.

Although considerable difficulty was encountered in holding the flow meter in an advancing wave, some variable though significant results were obtained (see Fig. 2). It was established that the maximum speed of the swash varied between different waves and with the depth at which the readings were taken. Consequently several repeated readings were required on each beach examined. The maximum speed of the swash was always found to be greater than the backwash. It was generally greater on a steep beach than on gentle beaches. Likewise the difference in maximum speeds, swash minus backwash, was greater for the steeper beaches. The least square empirical relation between the slope of the beach,  $\phi$ ; and the difference in speeds is

$$\phi_{0-10^\circ} = 0.43 + 0.14 (U_s - U_b) \quad (2)$$

where  $\phi$  is in degrees and  $U_s$  and  $U_b$  are in cm./sec.

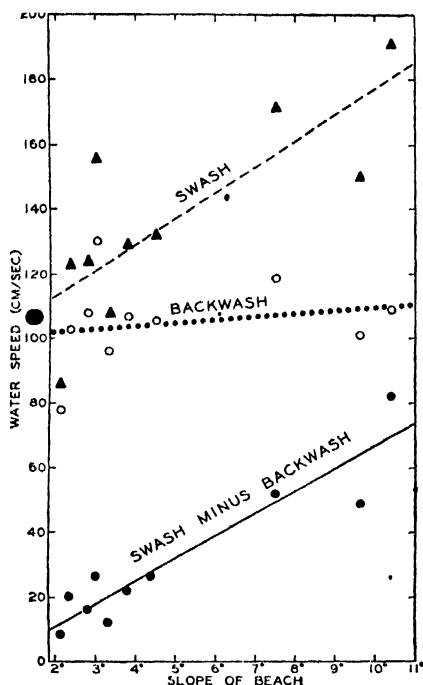

FIG. 2. Observed maximum speed of swash, backwash, and difference in speed (swash minus backwash) on beaches of various slopes.

#### BEACH EROSION

According to Hjulström<sup>6</sup> the speed of flow required to transport sand depends upon the size of the grains. His graph shows

$$U \leq 7.5d \quad (3)$$

where  $d$  is diameter of sand grains in mm. and  $U$  is water speed in cm./sec. This means that a medium-size grain of 0.3 mm. diameter requires only a speed of 2 cm./sec. for transportation.

Since the maximum speed of the water even on gentle beaches is greater than 2 cm./sec., sand is continually moved by both the swash and backwash. At any instant the transport on and off shore will depend upon the slope of the

beach and the speeds of the swash and backwash. To transport sand up the beach with a slope  $\phi$

$$U_s \leq 7.5d + a \sin \phi \quad (4)$$

and

$$U_b \leq U_s - 2a \sin \phi \quad (5)$$

To establish whether the shoreward or offshore transporting forces predominate requires knowledge of the transporting ability of all water speeds on all sizes, shapes and compaction of sand grains. The forces must be integrated with respect to time. In addition, the difference in volume of water must be considered since some percolates into the sand and returns to the sea by a subsurface route.

#### SUMMARY

These studies of waves, swash, and backwash have established that the wave period is less than the swash period. The difference between these periods increases inversely with the slope of the beaches. Also established is that the speed of the swash is greater than the backwash. The difference in speeds increases directly with the slope of the beach.

The dynamics of the end of a wave are seen to form a complex, though important, oceanographic problem, especially in the study of beach erosion and dissipation of wave energy.

#### ACKNOWLEDGEMENTS

The authors are grateful for the helpful suggestions of Professor C. Mahadevan, Head of the Geology Department, Andhra University. One of us (R. P. R.) is thankful to Mr. M. B. R. Rao, Director of Geophysics, Oil and Natural Gas Commission, for his interest in the work.

1. LaFond, E. C. and Prasada Rao, R., *Curr. Sci.*, 1953, **22** (9), 264-65.
2. —, *Andhra Univ. Memoirs in Oceanog.*, 1954, **1**, 66-77.
3. Prasada Rao, R., *Curr. Sci.*, 1954, **23** (2), (48-49).
4. Borreswara Rao, C. and LaFond, E. C., *Ibid.*, 1956, **25**, 77-79.
5. Emery, K. O. and Gale, J. F., *Trans. of Adm. Geoph. Union*, 1951, **32** (1), 31-36.
6. Hjulström, Filip, *Recent Marine Sediments*, 1939, pp. 5-31.

#### NEW SUPERCONDUCTORS

IN the course of a detailed study of the superconducting behaviour of uranium alloys at temperatures 1-2° K., Dr. B. S. Chandrasekhar and Dr. J. K. Hulm, of the Westinghouse Research Laboratories, found for the first time four superconductors among the 'intermetallic compounds' of uranium. The compounds are formed when uranium is chemically combined

with such metals as aluminium, manganese, cobalt, iron and nickel. Of special interest is the fact that two of them are the first superconducting compounds ever known to contain manganese and iron, two elements that always have been considered incompatible to the existence of superconductivity.

**SEISMIC EXPLORATION FOR OIL IN THE CAMBAY AND NEIGHBOURING AREAS, BOMBAY STATE\***

L. N. KAILASAM

*Geological Survey of India*

**T**HE recent discovery of oil near Cambay as a result of the drilling operations at present being carried on by the Oil and Natural Gas Commission is a culmination of intensive and detailed geophysical investigations carried out in that area by the Geological Survey of India during the period 1948 to 1957, resulting in the location of the Lunej structure by reflection seismic exploration.

The geological features of the areas surrounding the alluvial tract of Gujerat and Eastern Saurashtra are indicated in the sketch map

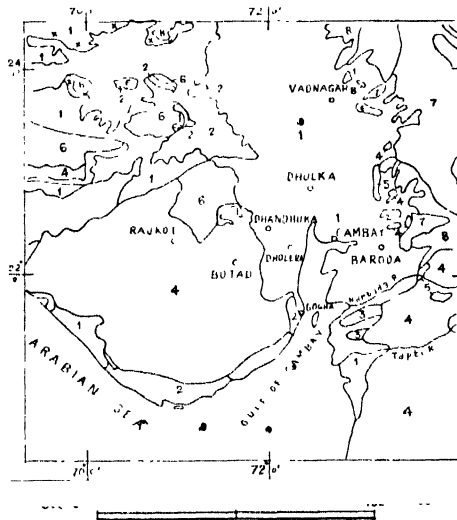

FIG. 1

1. Pleistocene & Recent. 2. Siwalik System Coastal Tertiary Deposits. 3. Tertiary (Eocene). 4. Deccan Trap. 5. Cretaceous. 6. Jurassic Upper Gondwanas of the Peninsula. 7. Dharwarian. 8. Granites & Gneisses.

shown in Fig. 1, which is based on the geological map of India, published by the Geological Survey of India. On the west, the alluvial tract is bounded by Deccan Trap of the Kathiawar Peninsula and the Jurassic sandstones of North-Eastern Kathiawar and Kutch. Several exposures of trap rock occur on the eastern flank of this alluvial tract, but the major part of these exposures comprises rocks of the Aravalli system and crystalline gneisses. Outcrops of tertiary sediments can be seen on

either side of the Gulf of Cambay. This fact coupled with the known occurrence of natural gas in the Gogha area on the eastern coast of the Kathiawar Peninsula, encountered in a borehole sunk to a depth of 1,016' in 1930 for ground water, formed the basis of the geophysical investigations carried out in this area by the Geological Survey of India.

Reconnaissance magnetic surveys were carried out by S. L. Banerjee and party during 1948-49 over the Gujerat alluvium in an area extending from Wadhwan in the west to Godhra in the east and from Ahmedabad in the north to Cambay in the south. On the basis of the magnetic anomalies, Banerjee inferred that the alluvial area to the north of the Gulf of Cambay is characterised by two faults disposed with a roughly north-south trend, one on the western side passing through Gundi in Eastern Saurashtra and another along the Mahe River in the east. He further postulated the thickness of the sediments to be maximum in the Cambay area, being of the order of 10,000-12,000' due to the down-faulting of the basement rocks.

Further detailed gravity and magnetic surveys were carried out by B. S. Negi and party during the field seasons 1951-52 and 1952-53 over the region extending from the Mahe River in the east to the west of the Sabarmati River and from Anand to the Gulf of Cambay in the north-south direction. Some strong regional as well local gravity and magnetic anomalies were outlined as a result of these surveys, including a prominent gravity-cum-magnetic anomaly in the area to the north and west of Cambay town.

The gravity and magnetic anomalies outlined by Negi were taken up, for detailed reflection seismic investigations by a geophysical party led by the author and assisted by R. S. Chellam and others during the field season 1956-57.

A prominent buried structural 'high' was indicated in the Paldi area by the seismic data, confirming thus the gravity and magnetic anomalies observed earlier. This structure in the Paldi-Lunaj area was located and partly outlined in the season 1955-56 and the seismic mapping of this structure was continued and completed during the 1956-57 season.

\*Published with the kind permission of the Director, Geological Survey of India.



A typical seismogram from the Cambay area is reproduced in reduced form in Fig. 2. As can be seen, a number of reflections are brought out in the records. Of these, five are consistent and well defined, having associated

imum thickness of the sediments occurring approximately in the region between longitudes  $72^{\circ} 28' E.$  and  $72^{\circ} 48' E.$  including Cambay and the adjacent areas to the north. The seismic data further indicates a depth of the order of

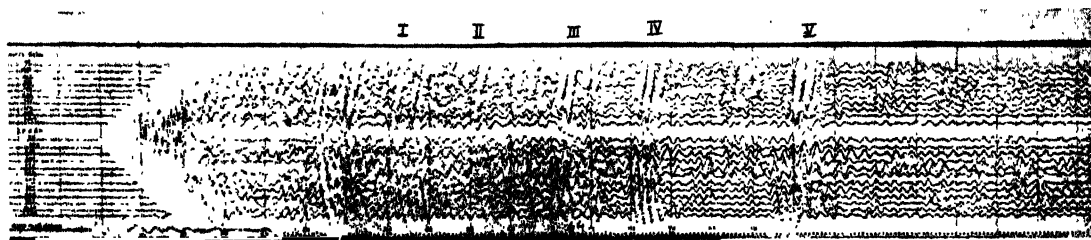

FIG. 2

two-way times of the order of 0.73, 0.90, 1.18, 1.40 and 1.78 seconds respectively. These are designated as reflections I to V. The last of these reflections is characterised by particularly strong intensity. This reflection which should be arising from a compact, strongly reflecting horizon is of special interest inasmuch as it may represent the top of the Deccan Trap, in which case the potentialities of the area for the occurrence of petroleum are considerably enhanced. The seismic observations were therefore extended along two long traverses, one from Cambay to Dholera in the west (see Fig. 1) where trap rock had been encountered at a depth of about 1,100' in a borehole drilled for water, and the other eastward from Cambay connecting up with the trap rocks occurring to the east of the Mahe River. Although the reflection obtained from the trap surface at the borehole near Dholera does not have the same characteristic intensity as reflection V in the Cambay area, the latter could be followed across the Sabarmati River—where no shooting was possible for a stretch of two to three miles on the traverse—upto the Dholera borehole. While the seismic results do not provide any evidence of a major fault occurring on the western side of the Gulf of Cambay, the data indicates that the horizon identified with the trap surface at the Dholera borehole regularly and continually slopes eastwards across the Sabarmati River through what appears like a series of minor step faults. From Cambay to the east, the same horizon regularly and progressively slopes upwards up to the trap exposures occurring to the east of the Mahe River without having undergone any faulting. The Gujerat alluvium to the north of the Gulf of Cambay is thus characterised by a broad, synclinal basin lying roughly within longitudes  $70^{\circ} 15' E.$  and  $73^{\circ} 10' E.$  across the Sabarmati and Mahe Rivers, the maxi-

1,500' for the thickness of the alluvium in the Cambay area.

The structure in the Paldi-Lunej area was mapped by detailed seismic shooting carried out over several traverses in the area. Phantom horizons have been drawn for three of the well defined reflections, II, IV and V mentioned earlier with two-way times of the order of 0.90, 1.40 and 1.80 seconds corresponding to depths of the order of 3,000, 5,100 and 7,000' respectively. Contour maps drawn for these phantom horizons for the reflections II, IV and V indicate a closed structure for both the horizons IV and V. In Fig. 3 is shown the contour map

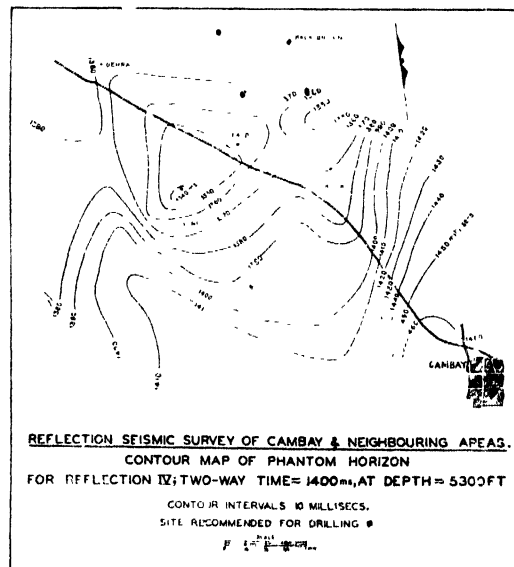

FIG. 3

for horizon IV. It may be seen that the closed structure near Lunej is clearly brought out. The site recommended for test drilling is also indicated therein. It may be mentioned here that

oil has also been struck, as reported, at a depth of 1,600 metres, closely corresponding to this horizon.

Inasmuch as the Lunej structure has now proved oil, it will be advantageous to extend the seismic investigations to the neighbouring areas to the north and west of Cambay where additional gravity and magnetic anomalies have been noted.

Thanks are due to all the colleagues of the author who participated in these surveys and to Shri M. B. Ramachandra Rao for valuable suggestions.

1. Banerjee, S. L., "Report on Reconnaissance Geophysical Survey in Eastern Saurashtra and Gujerat." Unpublished Report, Geological Survey of India, 1949.
2. Negi, B. S., "Gravity and Magnetic surveys for subsurface structures in Borsad area, Kaira District, Bombay." Unpublished Report, G. S. I., 1952.
3. Negi, B. S., "Gravity and Magnetic surveys for subsurface structures in the area to the north-west of Cambay." Unpublished Report, G. S. I., 1954.
4. Kailasam, L. N., "Reflection seismic investigations in the Cambay and Dholera areas, Bombay State." Unpublished Report, G. S. I., 1956
5. —, & R. S. Chellam, "Report on the Reflection seismic investigations in the Cambay and neighbouring areas, Bombay State." Unpublished Report, G. S. I., 1957.

### TESTING AND STANDARDISATION OF FOUNDRY MATERIALS\*

**C**ONSISTENCY in the quality of castings produced by a foundry depends greatly upon the control of the quality of a number of complex raw materials—sands, binding materials like bentonite, core oils and resins, fuel, air, metals, master alloys, fluxes, pattern materials, etc., used under severe conditions of temperature and erosion. An evaluation of their actual performance in relation to their fundamental properties will be of immense use to the foundry engineers.

According to Dr. Zang, three important criteria could be used to test bentonites for steel foundry use. To indicate that the sample has sodium as the main exchangeable ion, which gives high green strength to moulding sands, the pH should not be less than 8.2 and the calcium oxide content should not be more than 0.70%. Being a layer type of mineral, bentonite progressively increases in plasticity with increase in water content, till at a certain proportion of water to dry clay substance—known as the liquid limit—there is an abrupt increase in plasticity. The liquid limit for bentonites for steel foundry use should not be less than 525.

\* A scientific account of the Symposium on "Testing and Standardisation of Foundry Materials" held under the auspices of the Bangalore Chapter of the Indian Institute of Metals, at the Indian Institute of Science, Bangalore, on 9th and 10th October 1958.

The mechanism of heat transfer in sand moulds is discussed. By a proper choice of materials and of disposition of mould masses, the rate of heat dissipation from the liquid metal can be so regulated as to obtain higher and more uniform mechanical properties of the resultant casting. This paper also discusses the use of metal moulds and points out the advantage of anodized aluminium as metal mould because of its heat transfer characteristics. Zircon sands also offer interesting possibilities.

Radiographs of sand compacted into a standard V-notch show that the mobility of sand grains adjacent to the pattern surface is governed by friction and by pattern contour. Higher packing density is obtained when such friction is reduced either by using a dry lubricant like talc or by vibration.

Magnesium contents of less than 0.1% in iron of suitable chemical composition bring about spherodization of graphite with revolutionary changes in its properties, particularly in ductility. Phosphorus is the principal element that precludes the suitability of Indian pig iron for the manufacture of spherodized graphite iron. Under Indian conditions, S. G. iron can be manufactured only by the use of a charge mostly of steel scrap and S. G. Foundry returns in electric melting furnaces.

### OBITUARY—DR. K. C. PANDYA

**W**E regret to announce the death of Dr. K. C. Pandya, Retired Professor of Chemistry, Agra University, and a member of the Current Science Association. A Fellow of the Indian Academy of Sciences, he and his students contributed many papers to the *Proceedings of the Academy*. Dr. Pandya was mainly res-

ponsible for collecting and publishing in book form a series of radio talks on scientific subjects by Sir C. V. Raman. This book was later republished by the Philosophical Library of New York, and also by a publisher in Japan where it is used as a text for science students learning English.

## LETTERS TO THE EDITOR

STRESS AND WAVELENGTH DEPEND-  
ENCE OF BIREFRINGENCE IN  
CUBIC CRYSTALS IN THE VISIBLE  
REGION

THE relation between stress and the stress-induced birefringence in cubic crystals has been studied by us in the wavelength range 4,800-6,000 Å employing for the purpose a modified form of Filon's Spectrometer Method described by us in an earlier paper<sup>1</sup> on some alkali halides.

We have now extended the method to the study of eight more cubic crystals given in Table I. It will be noticed that the present results agree with those of previous observers.<sup>2</sup>

nitrates of Table I, show a variation with wavelength of light. In general, they tend to decrease with increasing wavelength. However, in thallium alum and potassium iodide  $q_{44}$  and  $(q_{11} - q_{12})$  respectively show an increase. The behaviour of KI in this respect is similar to what has been observed in KCl and KBr. The potassium ion is common to all the three crystals and the systematic differences noted in Table II arise with the change of the negative ion.

$(q_{11} - q_{12})$  and its dispersion (the ratio of total change in  $q_{11} - q_{12}$ , over the range of wavelengths studied, to its value at the mean wavelength) steadily increase as the negative ion changes from Cl through Br to I. The opposite effect is observed in  $q_{44}$ .

TABLE I

Crystal	$(q_{11} - q_{12}) \times 10^{13}$ c.g.s.	Dispersion %	$(q_{11} - q_{13}) \times 10^{13}$ c.g.s.	Dispersion %	$q_{44} \times 10^{13}$ c.g.s.	Dispersion %
KI	.. + 1.846	19.7	..	..	-3.042	1.7
LiF	.. - 1.410	6.6	..	..	-0.728	27.3
CaF <sub>2</sub>	.. - 1.478	2.0	..	..	+0.810	3.7
K-Alum	.. - 5.225	4.6	- 4.660	4.3	-0.696	14.9
NH <sub>4</sub> -Alum	.. - 5.325	10.3	- 4.575	6.8	-1.194	18.3
Ba(NO <sub>3</sub> ) <sub>2</sub>	.. - 22.88	8.5	-17.16	8.3	-1.680	9.5
Pb(NO <sub>3</sub> ) <sub>2</sub>	.. - 18.88	15.5	-10.96	3.6	-1.292	4.7
Thallium Alum	.. ..	..	..	..	+0.808	30.2

The relative retardation occurring in unit thickness of the crystal has been measured for stresses ranging from 0 to 50 kg. per sq. cm. at several wavelengths of light. Owing to the fragile nature of some of the crystals, particularly the alums, it is not possible to increase the stress much further. The plots of retardation *versus* stress for every one of the crystals are strictly linear when the stress applied is in the direction [001] and the directions of observation are either [010] or [100]. This linearity also obtains for stresses in the direction [111] and observation along [211]. As in the case of alkali halides studied earlier,<sup>1</sup> all crystals show a small residual birefringence of the tensional kind.

The quantities  $(q_{11} - q_{12})$  and  $q_{44}$  which describe the stress optical behaviour of KI, LiF and CaF<sub>2</sub>, and the additional quantity  $(q_{11} - q_{13})$  which characterises the alums and

TABLE II

Crystal	$(q_{11} - q_{12}) \times 10^{13}$ $\lambda = 5890 \text{ Å}$	Dispersion %	$q_{44} \times 10^{13}$ $\lambda = 5890 \text{ Å}$	Dispersion %
KCl	.. +1.47	7.8	-4.94	4.6
KBr	.. +1.76	12.0	-4.42	2.3
KI	.. +1.84	19.7	-3.04	1.7

The crystals NaCl, LiF, K and NH<sub>4</sub> alums, Ba and Pb nitrates in which the signs of both  $(q_{11} - q_{12})$ , and  $q_{44}$  are negative, belong to group II of Pockel's classification. The dispersions in them are found to be similar—all of them showing a decrease with increasing wavelength and the magnitude of the dispersion, given in Table I as a percentage, is usually higher in  $q_{44}$  than in  $(q_{11} - q_{12})$  or  $(q_{11} - q_{13})$ .

The crystals of Table II fall under Group IV of Pockel's classification showing a greater dispersion in  $q_{11} - q_{12}$  than in  $q_{44}$ .

Physics Dept., K. S. IYENGAR.  
Osmania University, K. G. BANSIGIR.  
Hyderabad, May 2, 1958.

1. Bansigir, K. G. and Iyengar, K. S., *Proc. Phys. Soc.*, 1958, **71**, 225.
2. Bhagavantam, S. and Suryanarayana, D., *Nature*, 1948, **162** 740.  
— and —, *Acta. Crystall.*, 1949, **2**, 26.  
— and —, Krishna Rao, K. V., *Nature*, 1953, **172**, 415.  
— and —, *Acta. Crystall.*, 1953, **6** 799.  
— and — *Proc. Ind. Acad. Sci.*, 1953, **37 A**, 589.  
Krishna Rao, K. V. and (Miss) Kalpagam, V., *Curr. Sci.*, 1955, **24**, 228.  
Pockels, F., *Ann. d. Phys.*, 1889, **37**, 372.  
Burstēin, E. Smith, P. and Henvis, B., *Phys. Rev.*, 1948, **74**, 229, 1880.  
— and —, *Naval Research Laboratory*, 1948.  
West, C. D. and Makes, A. S., *Chem. Phys.*, 1948, **16**, 427.  
— and —, *Research Report of the Office of Naval Research*, May 1951.

### ETCHING OF FLUORITE

EXPERIMENTS on etching of crystal surfaces have been reported in recent years.<sup>1-4</sup> We report here some interesting results obtained in the case of fluorspar in our Laboratory.

The two (111) faces obtained on cleaving a crystal of fluorite by means of a sharp blow with a pointed edge, were etched by sulphuric acid at room temperature for different times. The etched surfaces were then coated with highly reflecting silver films and examined under a microscope. It is observed that in the initial stages, there is general etching with scattered triangular etch pits. As the etching period is increased, etch pits resembling the familiar block pattern, as reported in the case of diamond, appeared at some places. The more scattered triangular etch pits were found to be randomly distributed but oriented in definite directions and to have point-to-point correspondence in the two faces. These pits may be due to inclusions or other types of imperfections such as dislocations. The detailed results will be published elsewhere.

Physics Dept., N. S. PANDYA.  
M. S. University of Baroda, J. R. PANDYA.  
Baroda, June 9, 1958.

1. Omar, M., Pandya N. S. and Tolansky, S., *Proc. Roy. Soc.*, 1954 **225A**, 33.
2. Gilman, J. J. and Johnston, W. G., *J. Appl. Phys.*, 1956, **27**, 1018.
3. Patel, A. R. and Tolansky, S., *Proc. Roy. Soc.*, 1957, **243 A**, 33.
4. Amelinckx, S., Bontinck, W. and Maenhout Vander Vorst, *Physica*, 1957, **23** (3), 270.

### A NOTE ON CONDUCTOMETRIC STUDIES ON COPPER TUNGSTATES

THERE is hardly any reference in literature to the study of the reaction between  $\text{CuSO}_4$  and  $\text{Na}_2\text{WO}_4$  by physico-chemical methods.

Standard solutions of A.R. quality reagents  $\text{Na}_2\text{WO}_4$  and  $\text{CuSO}_4$  were prepared in conductivity water and used in the present work. The conductivities were measured by Kohlrausch Universal Bridge (W. G. Pye, Ltd.), keeping the titration cell immersed in a thermostat maintained at  $30 \pm 1^\circ \text{C}$ . The conductance obtained after each dilution was corrected for dilution effect.<sup>1</sup> Using different concentrations of the reactants, the titrations were performed both by direct and reverse methods, in aqueous and aqueous alcoholic media. The pH of the solutions was measured with a glass electrode.

From conductometric curves (Fig. 1), it may

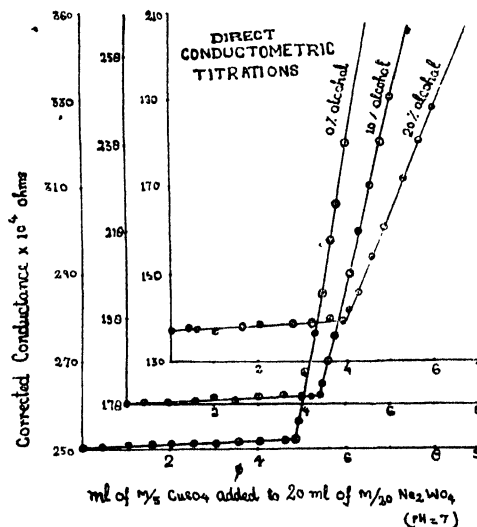

FIG. 1

be observed that a sharp break is obtained at a point which corresponds to the formation and precipitation of normal  $\text{Na}_2\text{WO}_4$  at pH 6.0-6.5. When  $\text{CuSO}_4$  is added to  $\text{Na}_2\text{WO}_4$ , there seems to be no change in conductivity as the mobility of  $\text{SO}_4^{2-}$  ion is nearly of the same order as that of  $\text{WO}_4^{2-}$  ion, but when the end-point is reached, a slight excess of  $\text{CuSO}_4$  increases the conductivity. The results of chemical analysis agree with the above compound. Reverse titrations give satisfactory results (with an obtuse angle between the intersecting lines) in uniformity with those obtained by direct methods. Definite amounts of acid  $\text{HNO}_3$  were added to  $\text{Na}_2\text{WO}_4$  solution and again conductometric titrations were performed. Fig. 2 reveals that

a break in the curve is obtained at a point where the molecular ratio of the reactants  $\text{CuSO}_4$  and  $\text{Na}_2\text{WO}_4$  is as 1:4, corresponding to the formation of copper metatungstate

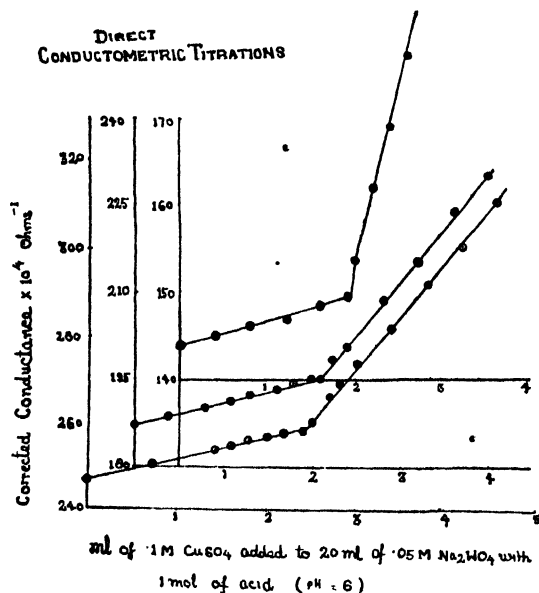

FIG. 2

$\text{CuO} \cdot 4 \text{WO}_3$ , at pH ranging from 4.8 to 5.2. The precipitate of this metatungstate seems to be colloidal. On analysing it for the metal and tungsten contents, the results almost agreed with the above ones. The formation of this compound can probably be explained by the fact that the species of tungstate ion existing in solution depends on the H ion concentration, according to G. Jander and co-workers.<sup>2</sup> The different tungstate ions are in equilibrium with each other and in weakly acidic range (4.8-5.5), it is interesting to find copper metatungstate  $\text{CuO} \cdot 4 \text{WO}_3$ , precipitating. This is further supported by the fact that metatungstates

have a weakly acidic reaction.<sup>3</sup> No precipitate of copper tungstate is obtained in the acidic range beyond 4.8.

The role of alcohol is to decrease the solubility of copper tungstate in water, and hence a closer approach to theoretical titre values is obtained when the titrations were carried in aqueous alcoholic media.

The determination of solubility products of various copper tungstates is in progress and the results would be communicated later.

Grateful thanks are due to Dr. S. Ghosh, Head of the Department of Chemistry, University of Allahabad, Allahabad, for kindly introducing us the subject of study.

Chemical Lab.,  
Government College,  
Kota, July 30, 1958.

R. S. SAXENA.  
C. M. GUPTA.

1. Davies, *Conductivity of Solutions*, p. 238.
2. Emeleus and Anderson, *Modern Aspects of Inorganic Chemistry*, 10th Revised Edition, 1952, p. 214.
3. Throne and Roberts, *Inorganic Chemistry*, 5th Edition, 1948, p. 521.

#### KINETIC STUDIES IN CHROMIC ACID OXIDATIONS

As part of the programme on the role of solvent in chemical reactions, the oxidation of secondary alcohols by chromic acid under controlled conditions was taken up. Waters,<sup>1</sup> Wesheimer<sup>2a, b</sup> and Kuivila and Becker<sup>3</sup> have reported on the mechanism of the reaction under other conditions and found the reaction to be of the first order with reference to the alcohol as well as the chromic acid used in their studies. Our present observations with isopropyl alcohol as well as with cyclohexanol confirm the reaction order using acetic acid as the solvent medium.

As one of the reactants is an ionic one, the reaction should show clearly the influence of ionic environment. The change in ionic strength

TABLE I  
Concentration of alcohol: 0.45145 M  
Concentration of chromic acid: 0.00669 M  
Concentration of potassium acetate: 0.2 M

% of acetic acid (by vol.) in the acetic acid-water mixtures	Isopropyl alcohol—Second order rate const. $\times 10^5$			Cyclohexanol—Second order rate const. $\times 10^5$		
	35° C.	40° C.	45° C.	35° C.	40° C.	45° C.
30	0.676	0.9822	1.249	2.397	2.628	2.774
40	1.387	2.0510	2.63	3.849	5.354	5.759
50	2.834	3.784	5.685	5.751	8.153	9.867
60	5.880	9.268	10.29	11.605	16.87	20.16
70	13.58	19.03	27.03	31.07	40.597	49.87

in the course of the reaction was noticeable in the pronounced trend in the rate constants and this was avoided by the initial addition of adequate quantities of pure potassium acetate. This incidentally helped in keeping the hydrogen ion concentration constant. Under these controlled conditions, the reaction was followed by iodometric estimation of the unreacted chromic acid. A summary of the observations is presented in Table I.

The plot of  $\log k_2$  against the reciprocal of the absolute temperature shows a clear linearity but the Arrhenius activation energies obtained are abnormally low, being of the order of 2.5 k.cals. The complex nature of the reaction is obvious. The frequency factor appears however to be less abnormal, though the value of  $10^{10}$  is still rather low. Though acetic acid and water do not form ideal mixtures, within the range of composition studied, the dielectric constant changes may be expected to show approximate linear behaviour. This may be expected to be reflected in the reaction rate. The  $\log k_2$ -composition curves (Fig. 1) with both alco-

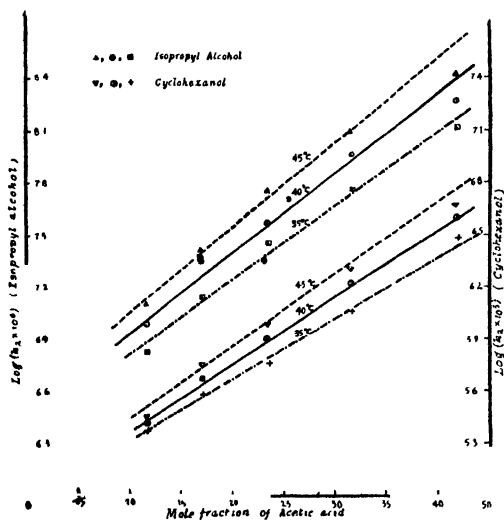

FIG. 1

hols bring this out. The slopes of the curves in the case of cyclohexanol suggest that for an initial small addition of acetic acid, the temperature coefficient will be negligible, confirming further the complexity of the reaction.

Fuller details will be published elsewhere.

Dept. of Chemistry,  
Madras Christian College,  
Tambaram, July 8, 1958.

S. V. ANANTAKRISHNAN,  
N. VENKATASUBRAMANIAN,

1. Slack and Waters, *J. Chem. Soc.*, **1948**, 1666; *Ibid.*, **1949**, 599.
- 2 a. Westheimer and Novick, *J. Chem. Phys.*, **1943**, **11**, 506.
- 2 b. Merrill Cohen and Westheimer, *J. Am. Chem. Soc.*, **1952**, **74**, 4387.
3. Henry Kuivila and Becker, W., *Ibid.*, **1952**, **74**, 5329.

### STANDARD RESACETOPHENONE OXIME IN SPECTROPHOTOMETRY

[ABSTRACT.—In the present communication a simple method is described for standardising a solution of Resacetophenone oxime in aqueous alcohol. A known amount of resacetophenone oxime solution is added to a known excess of a solution containing copper. The precipitate of Cu-Rapox filtered off and the excess of copper in the filtrate determined by the thiosulphate method.]

It has been shown in earlier publications that resacetophenone oxime (2, 4-dihydroxy acetophenone oxime) hereafter styled as Rapox can be employed for the estimation of nickel,<sup>1</sup> separation and detection of copper and nickel<sup>2</sup> and for the standardisation of cyanide.<sup>3</sup> It is now found that this reagent can be used with the same facility for the spectrophotometric study of iron<sup>4</sup> and such other elements. During this study it became necessary to prepare a standard Rapox solution for different colorimetric estimations. These efforts have resulted in the development of the method described herein.

A solution of copper was prepared from Merck's copper sulphate that was recrystallised and it was standardised by sodium thiosulphate method (c.f. Vogel<sup>5</sup>). The solution was 0.592 M.

Rapox was prepared and purified by the method described by Bhatki and Kabadi.<sup>2</sup> A weighed amount of the reagent was then dissolved in 40% ethanol and made to a known volume. This solution was standardised according to the procedure given below for use in the spectrophotometric studies. Potassium iodide, sodium thiosulphate and all the other reagents utilised during the experiment were of Merck's extra pure quality.

A known excess of copper solution was pipetted out in a beaker, neutralised with sodium carbonate and dilute acetic acid added till the solution was clear. The solution was then adequately diluted and a known volume of Rapox solution was introduced drop by drop

TABLE

Amount of Rapox taken, mg.	N/20 Na <sub>2</sub> S <sub>2</sub> O <sub>3</sub> required for excess Cu, ml.	N/20 Na <sub>2</sub> S <sub>2</sub> O <sub>3</sub> corresponding to Cu, used up, ml.	Amount of Rapox found from the amount of Cu, used up, mg.	Weight of Copper-rapoximate mg.	Weight of Rapox found, mg.
250.7	281.0	15.0	250.7	297.0	250.8
334.3	275.9	20.1	335.9	393.5	332.3
417.9	270.9	25.1	419.5	493.0	416.3
501.4	266.1	29.9	499.7	590.0	498.3
608.6	255.8	40.2	671.9	787.5	665.1

with constant stirring. After copper-rapoximate was completely precipitated, the beaker was allowed to stand for some time and the solution later filtered through a sintered glass crucible (porosity 2 G 4). The precipitate was washed several times with cold distilled water. The filtrate and the washings were collected and made to a known volume in a measuring flask after the addition of a few c.c. of dilute H<sub>2</sub>SO<sub>4</sub>. A measured volume was then withdrawn and titrated against standard solution of sodium thiosulphate as usual. Blank titrations were also carried out with the copper solution. The precipitate of copper-rapoximate which was collected in each experiment in the sintered glass crucible was dried at 120° C. to constant weight. This was done to confirm the results obtained by the present method. The results are given in the Table.

Two of the authors (K. S. B. and A. T. R.) are obliged to Dr. B. V. Thosar of T.I.F.R. for his encouragement by way of the facilities that he gave during the progress of the work.

The Institute of Science and K. S. BHATKI.  
The Tata Institute of A. T. RANE.  
Fundamental Research, M. B. KABADI.  
Bombay-1, June 3, 1958.

1. Bhatki, K. S. and Kabadi, M. B., *J. Sci. and Industr. Res.*, 1952, 11 B, 346; 1953, 12 B, 226.
2. — and —, *J. Univ. Bom.*, 1955, 24 (3), 51-57.
3. —, *Analyst*, 1957, 82 (970), 24-26.
4. —, Rane, A. T. and Kabadi, M. B., Unpublished work.
5. Vogel, A. I., *A Text-Book of Quantitative Inorganic Analysis*, II Ed., 1953, pp. 334 and 343. Longmans, Green & Co., London.

### TOXICITY OF WHITE OIL

INVESTIGATIONS in the past few years have revealed that the epidemiology of epidemic dropsy appears to be related to the use of adulterated edible oils, especially mustard oil. Various views have been expressed as to the nature of the compounds present in adulterants, and supposed to

be specifically responsible for the characteristic lesions of epidemic dropsy. Argemone oil from the seeds of *Argemone mexicana* is said to be a very common adulterant of commercial mustard oil. Sarkar<sup>1</sup> isolated an alkaloid sanguinarine from argemone oil, and the proved toxic properties of the oil have been attributed to the presence of this alkaloid. Sen<sup>2</sup> reported the presence of mineral oils as adulterants in mustard oil, and directed attention to their toxicity. In particular, white oil, a cheap mineral oil, was found to be widely used as an adulterant for mustard oil and preliminary reports<sup>3,4</sup> indicated its toxic nature. Some animal experiments undertaken to evaluate the effects of white oil feeding gave following results:

1. Groups of mice and rats were fed with small daily doses of white oil mixed with their normal diet (0.5 c.c. of white oil/mice/day; and 1.0 c.c. of white oil/rat/day). The normal diet consisted of pieces of bread soaked in fresh milk containing a little marmite and a few drops of shark liver oil, supplemented with germinated gram and sweet potatoes. In 3 to 5 days, the experimental animals developed a condition characterised by rough dry skin with erect hairs, restlessness and loss of weight. Continuation of the feeding of white oil led to the death of all animals within 7 to 10 days of the experiment. The animals had no other outward symptoms during this period and at the time of death. The animals of the control group, fed with the same basal diet containing equivalent amounts of pure mustard oil, were free from all symptoms. Fig. 1 shows the conditions of one pair of experimental rats on the fourth day of the experiment; a pair of the control group on the same date are shown in Fig. 2 for comparison.

2. Preliminary histopathological examination of the organs of the experimental animals, after death, revealed diffuse fatty degeneration of the parenchymatous cells of the livers, proliferation of the reticulo-endo-

thelial cells of the splenic pulp, marked hypertrophy and hyperkeratosis of the epidermis together with cellular infiltration of the corium and degenerative changes in the ascending tubules of the kidneys. Further work is in progress.

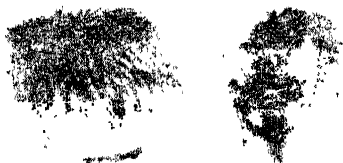

FIG. 1. Rats, on the 4th day of feeding with white oil.



FIG. 2. Rats, on the 4th day of feeding pure mustard oil (Control).

The author wishes to express his sincere thanks to Dr. A. Mukherjee, School of Tropical Medicine, Calcutta, for his help in the histological work.

Biochem. Section, H. D. BRAHMACHARI.  
Birla College of Science,  
Pilani (India), June 20, 1958.

1. Sarkar, S. N., *Nature*, 1948, **162**, 265.
2. Sen, S. N., *Cal. Med. Jour.*, 1909, **4**, 161.
3. Chaudhuri, R. N. and Chakraborty, N. K., *Ind. Jour. Med. Sci.*, Feb. 1952, **6** (2), 137.
4. Brahmachari, H. D. and Mukherji, A., *Proc. Ind. Sci. Cong.*, 1954.

### STUDIES IN THE REACTIONS OF $\alpha$ -KETO ACIDS

IN view of the large amount of experimental evidence published recently<sup>1-3</sup> on the chemistry of 2:3 pyrrolidinediones, we wish to make a preliminary report on the preparation of some of these diones and their chemical reactions. These diones were prepared by the condensation of phenyl- and 3:4 dimethoxyphenyl-pyruvic acids with aldehydes and amines in alcoholic solution. All of these compounds gave a blue to green colouration with alcoholic ferric chloride indicating the presence of an enolic hydroxyl group. They formed acetyl derivatives on heating with acetic anhydride and pyridine and at the same time furnished crystalline quinoxaline derivatives by condensation with *o*-phenylenediamine in acid solution (*vide* Table I). These facts point to the presence of an equilibrium mixture of the tautomeric forms.

TABLE I

No.	m.p. of pyrrolidinedione	Formula	Analysis			
			Found		Calculated	
			C%	H%	C%	H%
1	248°	C <sub>22</sub> H <sub>17</sub> O <sub>2</sub> N	80.2	5.0	80.73	5.19
2	256°	C <sub>24</sub> H <sub>21</sub> O <sub>3</sub> N	77.4	5.7	77.63	5.6
3	196°	C <sub>23</sub> H <sub>18</sub> O <sub>5</sub> N <sub>2</sub>	60.1	4.2	68.7	4.47
4	237°	C <sub>24</sub> H <sub>19</sub> O <sub>4</sub> N	74.7	5.2	74.8	4.9
	(d)					
5	221°	C <sub>24</sub> H <sub>21</sub> O <sub>3</sub> N	77.6	5.7	77.62	5.66
6	178°	C <sub>25</sub> H <sub>23</sub> O <sub>4</sub> N	74.6	5.9	74.81	5.73
7	205°	C <sub>26</sub> H <sub>24</sub> O <sub>6</sub> N	72.56	6.08	73.56	5.5
8	224°	C <sub>25</sub> H <sub>20</sub> O <sub>8</sub> N <sub>2</sub>	65.2	4.2	64.9	4.32
	(d)					

No.	m.p. of acetyl derivative	Formula	Analysis			
			Found		Calculated	
			C%	H%	C%	H%
1	184°·5	C <sub>24</sub> H <sub>19</sub> O <sub>4</sub> N	78.5	5.0	78.01	5.19
2	218°	C <sub>26</sub> H <sub>23</sub> O <sub>4</sub> N	75.8	5.78	75.5	5.5
	(d)					
3	225°	C <sub>25</sub> H <sub>20</sub> O <sub>6</sub> N <sub>2</sub>	67.55	4.5	67.56	4.54
	(d)					
4	207°	C <sub>26</sub> H <sub>21</sub> O <sub>5</sub> N	72.9	5.1	73.06	4.92
6	165°	C <sub>26</sub> H <sub>23</sub> O <sub>4</sub> N	75.9	5.6	75.5	5.5
6	155°	C <sub>27</sub> H <sub>25</sub> O <sub>5</sub> N	73.0	5.6	73.1	5.8
7	197°	C <sub>28</sub> H <sub>26</sub> O <sub>6</sub> N	71.5	6.1	71.14	5.5
8	219°	C <sub>27</sub> H <sub>22</sub> O <sub>9</sub> N <sub>2</sub>	62.8	4.3	62.5	4.2



No.	m.p. of quinoxaline	Formula	Analysis			
			Found		Calculated	
			C%	H%	C%	H%
1	252°	C <sub>28</sub> H <sub>21</sub> N <sub>3</sub>	84.3	5.2	84.2	5.4
2	210°	C <sub>30</sub> H <sub>25</sub> ON <sub>3</sub>	80.9	5.8	81.24	5.7
3	315°	C <sub>29</sub> H <sub>22</sub> O <sub>3</sub> N <sub>4</sub>	73.2	4.5	73.4	4.6
4	219°	C <sub>30</sub> H <sub>23</sub> O <sub>2</sub> N <sub>3</sub>	78.6	5.2	78.7	5.03
5	235°	C <sub>30</sub> H <sub>25</sub> ON <sub>3</sub>	81.2	5.7	81.24	5.7
6	157°	C <sub>31</sub> H <sub>27</sub> O <sub>2</sub> N <sub>3</sub>	78.6	6.0	78.64	5.7
7	193°	C <sub>32</sub> H <sub>26</sub> O <sub>3</sub> N <sub>3</sub>	76.0	5.6	76.3	5.8
8	270° (d)	C <sub>31</sub> H <sub>24</sub> O <sub>6</sub> N <sub>4</sub>	83.2	5.1	83.03	5.3

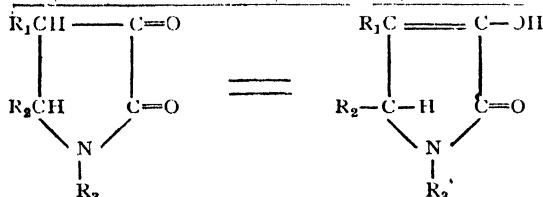

1.  $R_1 = R_2 = R_3 = C_6H_5$
2.  $R_1 = C_6H_5$ ;  $R_2 = C_6H_4.OCH_3$  (*o*);  
 $R_3 = C_6H_4.CH_3$  (*p*).
3.  $R_1 = C_6H_5$ ;  $R_2 = C_6H_4.OCH_3$  (*p*);  
 $R_3 = C_6H_4.NO_2$  (*m*).
4.  $R_1 = C_6H_5$ ;  $R_2 = C_6H_3.O.CH_2.O$  (*m, p*);  
 $R_3 = C_6H_4.CH_3$  (*m*).
5.  $R_1 = C_6H_5$ ;  $R_2 = C_6H_4.OCH_3$  (*p*);  
 $R_3 = C_6H_4.CH_3$  (*p*).
6.  $R_1 = C_6H_5$ ;  $R_2 = C_6H_3.(OCH_3)_2$  (*m, p*);  
 $R_3 = C_6H_4.CH_3$  (*p*).
7.  $R_1 = C_6H_3.(OCH_3)_2$  (*m, p*);  
 $R_2 = C_6H_4.OCH_3$  (*p*);  $R_3 = C_6H_4.CH_3$  (*p*).
8.  $R_1 = C_6H_3.(OCH_3)_2$  (*m, p*);  
 $R_2 = C_6H_3.O.CH_2.O$  (*m, p*);  
 $R_3 = C_6H_4.NO_2$  (*p*).

When  $\alpha$ -keto butyric acid was condensed with benzaldehyde and aniline in acetic acid solution at 0° C. the product obtained was a mixture which after repeated crystallisations gave a low yield of a compound of m.p. 223° C., which from the analysis results was identified as the 'anil' of the following structure. It did not give any colouration with ferric chloride solution.

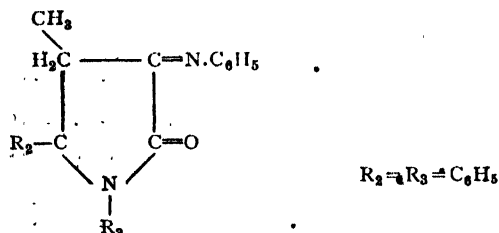

This is in agreement with the facts reported recently by Vaughan and Covey.<sup>1</sup> Condensation

of  $\alpha$ -keto butyric acid with benzaldehyde and *p*-toluidine gave two products of m.p. 193-95° C. and 175-77° C.

Further work on their structures is in progress.

The pyrolysis of compound (1) was carried out as described by Borsche,<sup>4</sup> but instead of the expected stilbene, only a colourless, crystalline compound of m.p. 336° C. was obtained. (Found: C, 84.4; H, 5.3; N, 4.6; C<sub>21</sub>H<sub>15</sub>ON requires C, 84.8; H, 5.0; N, 4.7.) It formed an acetyl derivative of m.p. 151° C. The pyrolysis product was identified as 2:3-diphenyl-4-hydroxyquinoline. Vaughan and Covey<sup>1</sup> have also reported the formation of this compound.

The action of phenylhydrazine on the pyrrolidinediones was attempted, but in contrast to the observations made by Meyer and Vaughan,<sup>2</sup> who have obtained different compounds with 1,5-diphenyl-2,3-pyrrolidinedione, in our hands the original substance was recovered unchanged.

We also wish to report that with some aldehydes and amines the two keto acids mentioned earlier gave either the Schiff's bases only or cinchoninic acids. Further work on these compounds is in progress and will be reported elsewhere.

(MISS) RASHMI J. SHAH.  
J. R. MERCHANT.

Dept. of Organic Chem.,  
Institute of Science,  
Mayo Road, Bombay-1,  
July 19, 1958.

1. Vaughan, W. R. and Covey, I., *J. Am. Chem. Soc.*, 1958, **23**, 2197.
2. Meyer, W. I. and Vaughan, W. R., *J. Org. Chem.*, 1957, **22**, 98; 1957, **22**, 1554; 1957, **22**, 1560; 1957, **22**, 1565.
3. Wassermann, H. H. and Koch, R. C., *Chem. and Ind.*, 1957, 428.
4. Borsche, W., *Ber.*, 1909, **42**, 4072.

### SOUTHERLY PITCHING ANTICLINE NEAR DODDAGUNI

DURING a recent survey of the southern extension of the Chitaldurg Schist Belt near Doddaguni (Long. 76° 46' and Lat. 13° 19'), a number of outcrops of ferruginous quartzites were found folded into anticlines pitching southwards. This belt consists of micaceous quartzites, schists, ferruginous quartzites, etc.<sup>1</sup> Among these the ferruginous quartzites stand out prominently and they form a range of hillocks running nearly north-south.

The ferruginous quartzites of this range preserve a good number of minor folds. In Fig. 1

is shown one of the most prominent minor folds found on the southern slope of the hillock  $\Delta$  2923. The figure shows the pitch of the fold

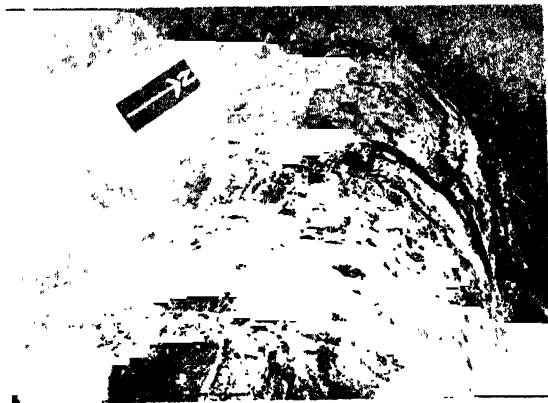

FIG. 1

towards south. There is a cross joint running perpendicular to the axis of the fold about which the outcrop has moved apart. The pitch of the fold was measured along the axial plane (strike) of the fold; it is  $28^\circ$  towards bearing  $166^\circ$ .

The pitch angle was also calculated by representing the trends of the limbs on a stereographic projection<sup>2</sup> (Fig. 2). The eastern limb

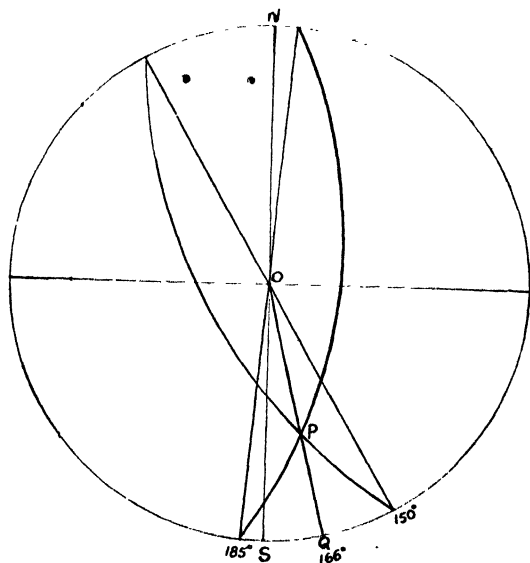

FIG. 2

strikes  $150^\circ$  and dips  $58^\circ$  and the western limb strikes  $185^\circ$  and dips  $62^\circ$ . Their stereographic traces intersect at the point 'P'. OPQ shows

the trend of the axis of the fold  $166^\circ$  and PQ is the pitch which is  $28^\circ$ .

The same range of hillocks shows many minor folds. Due to pitching, the limbs of these folds converge and the beds 'wrap around' the ends of the folds and die out forming 'noses'. The schists and micaceous quartzites also exhibit the same phenomenon. The 'noses' of all these formations show varying pitch from  $12-40^\circ$  in the same direction.

Very recently such a southerly pitching fold is reported from Satnur, Kanakapura Taluk, Bangalore District.<sup>4</sup>

Further studies of the region are in progress.

The author is grateful to Professor M. R. Srinivasa Rao, Department of Geology, Central College, Bangalore, for his valuable suggestions and guidance.

Dept. of Geology,

K. M. GURAPPA.

Central College,

Bangalore, June 5, 1958.

1. Pichamuthu, C. S., *Curr. Sci.*, 1937, **3**, 95.
2. Phillips, F. C., *The Use of Stereographic Projection in Structural Geology*, 1955, 14.
3. Nevin, C. M., *Principles of Structural Geology*, 1953, 44.
4. Suryanarayana, K. V., *Curr. Sci.*, 1957, **26**, 86.

### SOREL CEMENT AS A BINDER FOR POWDER FUEL WASTES

THE excellent cementing properties of Sorel Cement suggest its possible use as a binder for briquetting fuel wastes.<sup>1,2</sup> Experiments were carried out in this Institute to test its binding ability.

Powder wastes of coal and charcoal from the local market were ground and sieved. Figures for the sieve analysis of the powders used and the proximate analysis of the coal dust are given below:

B S.S. mesh	Sieve analysis		Proximate analysis of coal dust	
	Coal	Charcoal	%	%
- 14 + 18	11.5	10.5	Moisture	1.36
- 18 + 30	26.0	25.5	Ash content	31.00
- 30 + 60	26.5	24.0	Fixed carbon	49.22
- 60 + 100	15.0	18.0	Volatile matter	18.42
- 100 ..	21.0	22.0		

Low grade magnesium oxide (80% MgO) obtained by calcining Salem magnesite at  $1,000^\circ$  C. and crushed to - 170 B.S.S. mesh was used along with magnesium chloride solution of

No.	Property	Coal briquettes		Charcoal briquettes
		with 5% MgO	with 3% MgO	
1	Apparent Sp. Gr.	.. 1.3	1.2	0.8-0.9
2	True Sp. Gr.	.. 1.55	1.42	1.3
3	Porosity % calculated from $\left\{ \begin{array}{l} \text{Apparent Sp. Gr.} \\ \text{True Sp. Gr.} \end{array} \right\}$ 100-100	.. 16.1	15.5	30.0-38.5
4	% by weight of water absorption after 48 hours soaking	6.0-7.0	6.0-7.0	8.2
5	Weathering index	.. 1.4	4.3	4.8
6	Compressive strength (P.S.I.) after 21 days storage	.. 190	80	95

density 20-21° Be', as binder. The fuel powder was first lubricated with 12-15% of its weight of magnesium oxide. This was followed by the addition of just enough magnesium chloride solution to make a good wet mix. The thoroughly mixed material was packed into rectangular wooden moulds: 3' × 1½" × 1½". The bars were allowed to set for 18 hr., then removed from the moulds and cut into cubes of 1½" side. The cubes were sun-dried for 2-3 days.

A summary of the physical properties of briquettes, tested according to A.S.T.M. standards,<sup>3</sup> is given below:

Briquettes made with 5% MgO were found to be superior. As evident from the compressive strength tests, they could withstand rough handling for transport. Further, when tested, they were found not to break or chip when dropped thrice on an iron plate from a height of 6'.

The briquettes burn well without losing shape.

The author wishes to express his thanks to Dr. A. N. Kappanna, Assistant Director-in-Charge, for suggesting the problem and permitting the publication of this note.

Central Salt Res. Inst., MOHAN RAI.  
Bhavnagar, June 9, 1958.

1. Gyula Boschan, *Hung.*, Aug. 11, 1930, 103, 142.
2. Frankenstein *Magene sitwerke Akt., Ges. Bri.*, Oct. 11, 1924, 241, 175.
3. *A.S.T.M. Standards*, 1955, Part 5.

### PILLOW STRUCTURES IN THE RAMAGIRI SCHIST BELT, ANANTAPUR DISTRICT, ANDHRA PRADESH

Pillow structures were observed by the author in the Ramagiri schist belt for the first time during the field-season 1957-58, while he was engaged in detailed structural mapping of the belt on 8" to a mile scale with a view to assessing the economic potentialities of this abandoned gold field. Particular attention was paid to the structural and lithologic controls of gold

mineralisation, wall rock alteration and mineral paragenesis.

The pillow structures were noted at:

1. Nineteenth milestone and south of 19/6 milestone on the Dharmavaram-Peruru Road. Here the pillows are stretched in a N. 15° E. to N. 40° E. direction varying in length from 0.6" to 2.4" and in breadth from 0.2" to 0.6". The thickness of the skin varies from 0.25" to 0.5";

2. West of 21/4 milestone and about 4 furlongs west of Jubiti mines. The pillow structures (Fig. 1) occur in the massive metabasalts, which have occupied shear zones in these two localities, as was evidenced from the intense silicification and chertification of the outer skins of the pillows and crushing of the metabasalts. The pillows are oblong and imperfectly bun-shaped and the outer skin in some cases is drag-folded. They are elongated in N. 10° W. direction varying in length from 1" to 3.6" and the width of the skin is 0.25" to 0.75". The pillows here show westerly tops (Fig. 1).

Besides these occurrences, pillow structures were also noted in *in situ* outcrops of the flow-breccias in the Central Ramagiri belt, where it is possible to establish tops.

Thin sections of the greenstones from the core of the pillows reveal a fine-grained aggregate of small lath-shaped actinolite, chlorite, epidote, minor plagioclases and interstitial quartz. The dull-coloured skin of the pillows is generally coarse-grained and composed of the same minerals. Veinlets of coarsely laminated chlorite and epidote generally occur along the contact of the skin with the inner greenstone core.

The author had observed the pillow structures (Fig. 2) in the Penner-Haggari Dharwar belt, about 50 miles west of the Ramagiri belt, during his mapping of the Bellary District. The skin of the pillows shows three distinct zones consisting of an outer cherty zone of about 0.6" width, the central hornblendic zone of about 0.7", and the inner amygdular one of 1" thick

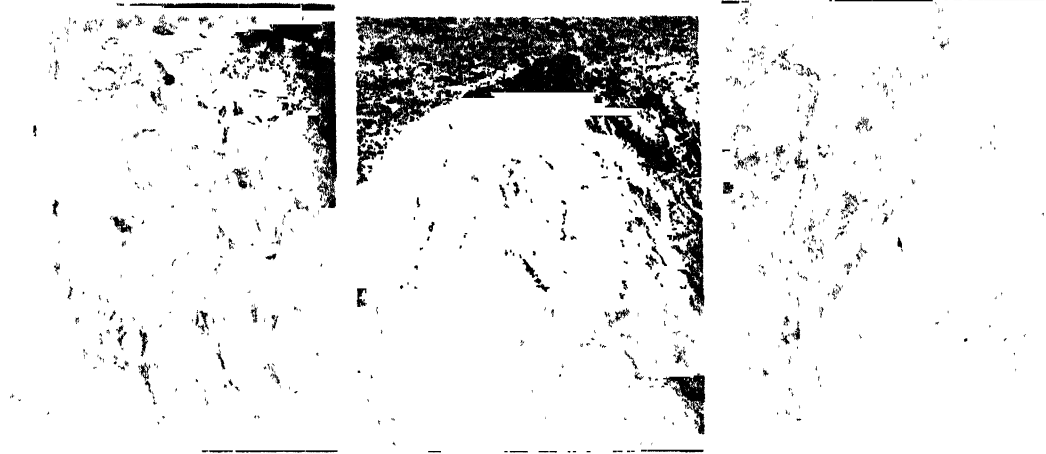

FIG. 1

FIG. 2

FIG. 3

FIG. 1. Pillow structures in the Ramagiri schist belt with westerly tops. ( $\sigma^7$ )

FIG. 2. Pillows from Penner-Haggari band with easterly tops. ( $\sigma^7$ )

FIG. 3. Zones in the outer skin of the pillows in the Penner-Haggari schist belt.

Zone 1: Cherty; Zone 2: Hornblendic; Zone 3: Amygdular.

(Fig. 3). Here the pillows show easterly tops (?) while in the Ramagiri belt they top west.

The presence of the pillow structures in most of the Dharwar schist belts in South India (i.e., Kolar, Ramagiri, Penner-Haggari, Sandur, Chitaldrug, etc.) is suggestive of the consanguinity in their tectonic and igneous histories, and might be grouped under one 'Volcanic Province'.

My thanks are due to Dr. B. C. Roy, Director, Geological Survey of India, for permitting me to present this note, and to Mr. S. Narayanaswami for his helpful suggestions.

Geological Survey of India, M. KRISHNAMURTY.  
July 14, 1958.

1. Bartrum, J. A., *Jour. Geol.*, 1930, **38**, 447.
2. Buddington, A. F., *Ibid.*, 1926, **34**, 824.
3. Capps, S. R., *Ibid.*, 1915, **23**, 456.
4. Foye, W. G., *Geol. Soc., Am. Bull.*, 1924, **35**, 329.
5. Lewis, J. V., *Ibid.*, 1914, **25**, 591.
6. McKinstry, H. E., *Jour. Geol.*, 1939, **47**, 202.
7. Narayanaswami, S., *Curr. Sci.*, 1955, **8**, 265.
8. Pitchamuthu, C. S., *Ibid.*, 1950, **4**, 110.

### ROOT RELATIONS OF OROBANCHE AND ITS HOSTS

AN extensive morphological study of *Orobanche* in relation to its various host roots at Varanasi revealed that the root branches of cruciferous hosts, specially of *Brassica* sp. on which the roots of *Orobanche cernua* grows, are more developed than the normal roots of the plant. In one case (Fig. 1) the only root branch on

which *Orobanche* was growing developed upto 50 cm. More interesting is the fact that the host roots were found to extend to the parasite roots sometimes to a considerable distance either plagiotropically or ageotropically.

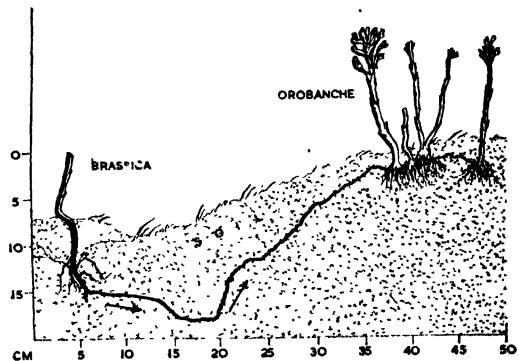

FIG. 1

*Orobanche* growing on *Brassica* sp. possesses poorly developed roots which entangle the *Brassica* roots. Roots of the former are hardly 1½" long and without hairs.

With storage roots as those of turnip and radish, the root system of the parasite is much developed as compared to the other cases. But in these cases also the roots of the host turned markedly upward just to reach the parasite. Further investigation is in progress to reveal the nature of this stimulus which is found to be absent with the hosts belonging to other families.

*Orobanche* is a complete root parasite as evidenced by the lack of chlorophyll. The present literature on it suggests that the seeds germinate only when they get hold of the host root. The parasitised plants have been found to have normal, if not healthier development of roots than other plants. Thus these three phenomena, viz.,

1. Much longer growth of parasitised root branches.

2. Negative geotropic curvature shown occasionally by the parasitised root branch.

3. The healthier growth of host plants led us to believe that the host has some affinity with *Orobanche*. The peculiar behaviour of the host root may be explained on the following two lines.

(a) There might be certain exudations from *Orobanche* which attract the nearest root of the host.

(b) The host derives some benefit from *Orobanche*.

We are very much thankful to Prof. R. Misra for guidance.

Dept. of Botany,  
Hindu University,  
Varanasi-5, June 10, 1958.

V. S. RAWAT.  
R. S. AMBASHT.

### ON THE PREVENTION OF MANGO NECROSIS

MANGO necrosis in which the distal end of the fruit becomes characteristically necrotic due to brick-kiln fumes has been shown to be checked or prevented to a large extent by boron treatment. When boron is sprayed on trees after fruits have developed early symptoms of necrosis, the disease is checked (Das-Gupta *et al.*, 1950),<sup>1</sup> while similar spray before the incidence of necrosis prevents the disease (Das-Gupta and Sen).<sup>2</sup> Further corroboration of this result was sought in a more intensive and wide-scale study of the spray effect of boron on mango necrosis this mango season (1958), and the results are briefly described here. The full paper will soon be ready for publication.

The experiments were conducted in two orchards known to suffer regularly from necrosis. Orchard I has one brick-kiln on west and three others on north-west direction all within a radius of half-a-mile from the orchard. This orchard has four major plots, A, B, C and D; A being nearest to the kiln, and D farthest. Orchard II has one brick-kiln on west and another on south within a radius of half-a-mile from the orchard. This orchard has five major

plots, A, B, C, D, and E of which A, B and C are nearest to and E farthest from the kiln. The different varieties of mango trees in both the orchards were *Dasehri*, *Safeda* and *Khajri*. All varieties develop necrosis to a varied extent.

In Orchard I spraying was done on 98 trees in plot A, 146 trees in plot B and 257 trees in plot C, and in Orchard II, 29 trees in plot A, 52 trees in plot B, 83 trees in plot C and 142 trees in plot D. The treatment was given thrice before flowering, during flowering and immediately after fruit-setting, with 6 lb. of borax per 100 gallons of well or canal water. Three hundred and eighteen trees in plot D of Orchard I and 83 trees in plot E of Orchard II were not treated, being kept as controls.

The progress of the disease was kept under observation periodically and a final fruit count made when the fruits have attained a size of approximately 4". However, it was observed that the crop was poor in Orchard II. Fruits showing least visible atiolation were considered as diseased fruits.

TABLE I  
Incidence of necrosis in boron-treated and control plants

Orchard No.	Plot No.	Treated (T) or Control (C)	No. of Healthy fruits	No. of diseased fruits	Total No. of fruits	Percentage of necrosis
I	A	T	1622	60	1682	3.57
	B	T	9293	115	9408	1.22
	C	T	3997	20	4017	0.50
	Total A, B, C,	T	14912	195	15107	1.28
	D	C	1070	1976	3046	64.87
II	A	T	267	..	267	0.00
	B	T	113	..	113	0.00
	C	T	445	21	466	4.50
	D	T	1357	8	1365	0.59
	Total A, B, C, D,	T	2182	29	2211	1.31
	E	C	204	158	362	43.65
Total	I & II	T	17094	224	17318	1.29
Total	I & II	C	1274	2134	3408	62.62

Thus in Orchard I the percentage of disease among test plants is 1.28 while that for the controls is 64.87; in Orchard II the percentage of disease among test plants is 1.31, against 43.65 in controls. Considering all the treatments together the percentage of disease among test plants is 1.29 while that of the controls is 62.62. Correcting for the percentage of healthy mangoes in control plants, it was found

statistically that the percentage of necrosis in test plants will be 2.06 when controls are 100% necrotic, i.e., 97.94% fruits are prevented from getting necrotic by treatment with borax.

The analysis of the data clearly shows that there is preventive effect of boron on mango necrosis. This and the results of the investigation of the past few years lead irresistibly to the conclusion that the mango necrosis can be successfully controlled by spraying the trees with sufficient quantity of boron.

Dept. of Botany, S. N. DAS-GUPTA.  
Lucknow University, C. SEN.  
Lucknow, June 16, 1958.

1. Das-Gupta, S. N., et al., Report Submitted to I.C.A.R., 1950, 257.
2. — and Sen, C., 1957, Unpublished.

#### ROLE OF NITROGEN IN HOST SUSCEPTIBILITY TO *PIRICULARIA* *ORYZAE* SAV.

THAT heavy nitrogenous manuring augments the disease-proneness of susceptible rice to *Piricularia oryzae* but not the resistant ones is well recognized.<sup>1-3</sup> Further, it is known that not infrequently normal susceptibles behave like resistant ones either in the field or in laboratory inoculation trials. In an attempt to explain this phenomenon on the basis of the environment altering the host metabolism, it has been repeatedly found in this laboratory that the prevailing nycotemperatures largely determine the susceptibility of rice to the blast disease.<sup>4</sup> Experiments conducted in this regard have shown that a nycotemperature of 20° C. alternating with day temperatures of 30-35° C. under a fixed illumination for 14 hr. and darkness for 10 hr. render the susceptible types to take infection. Whereas, in plants grown with higher nycotemperatures (above 26° C.), infection seldom occurs even on the susceptible types.

The effect of low nycotemperatures on the nitrogen metabolism of the host was investigated, and, indeed, it was found that low nycotemperatures favoured amide synthesis, especially glutamine which was identified chromatographically in the guttates. The concentration of this amide in the guttate characteristically increased when the plants were also heavily dressed with ammonium sulphate. The guttation fluid when dried on the leaf surface left easily identifiable macroscopic crystals, mainly of glutamine. When pure glutamine as well as that from the guttate was studied for their

effect on germination of *P. oryzae* spores, marked stimulation of germination was observed over a wide range of concentrations. But this stimulation was obvious only at a temperature of 24-26° C., a range established by many workers to be the optimum for infection of rice plants by *P. oryzae*. At temperatures below or above this optimum, glutamine had no stimulating effect, possibly, due to the disfunction of the glutamic decarboxylase system of the pathogen. Recently, Weintraub et al.,<sup>5</sup> reported the stimulating effect of guttates from rice on *Piricularia* spores but failed to identify the substance concerned with any of the number of sterols, steroidal sapogenins, steroidal amines and  $\alpha$ -tocopherol which also stimulated germination. But from the foregoing, it is evident that glutamine crystals on the leaf surface provide a readily assimilable substrate for the germinating *Piricularia* spores under the right conditions.

To sum up, it is clear that two factors are concerned in determining the host susceptibility to this disease in so far as the nitrogen metabolism of the plant is concerned. The foremost is the low nycotemperature which facilitates nitrate reduction and favours glutamine synthesis. Secondly, the prevalence of the optimum temperature (24-26° C.) aids the utilisation of this glutamine by the pathogen at the infection court. It is conceivable that at high nycotemperatures, amide synthesis is impaired as a result of low nitrate reduction as reported by Went<sup>6</sup> in the case of tomato leaves. Possibly, in this case, the products of photosynthesis are largely diverted to the formation of complex cell-wall materials like lignin and cutin which make the leaf-blade resistant to mechanical puncture by the germ tubes. It is not clear in what way the resistant types differ in glutamine synthesis from the susceptibles. It is however known that environmental conditions like long-day stimulus and night temperatures as well as genetical factors are involved in the biogenesis of glutamic and related compounds in plants.<sup>7</sup> Further work on the interrelationships of these factors in relation to glutamine synthesis by rice, resistant and susceptible to *P. oryzae*, is in progress and would be reported in detail elsewhere.

I wish to record my sincere thanks to Prof. Dr. T. S. Sadasivan, Director, University Botany Laboratory, Madras, and Dr. C. V. Subramanian for many helpful discussions and guidance. The award of a National Institute of Sciences of India Junior Fellowship is also gratefully

acknowledged during the tenure of which this work was carried out.

University Botany Lab., S. SURYANARAYANAN.  
Madras-5, July 29, 1958.

1. Thomas, K. M., *Detailed Administration Report of the Government Mycologist, Madras, for the year 1937-38*, 1938.
2. Sawada, K., *Jap. J. Bot.*, 1940, **10**, 62-63.
3. Krishnaswami, C. S., *Madras agric. J.*, 1952, **39**, 205-14.
4. Suryanarayanan, S., *Proc. Nat. Inst. Sci. India, B* (In Press).
5. Weintraub, R. L., Miller, W. E. and Schantz, E. J., *Phytopathology*, 1958, **48**, 7-10.
6. Went, F. W., *The Experimental Control of Plant Growth*, Chronica Botanica Co., Waltham, Mass., U.S.A., 1957.
7. Steward, F. C. and Pollard, J. K., *A Symposium on Inorganic Nitrogen Metabolism*. The John Hopkins Press, Baltimore, 1956, 377-407.

#### A NOTE ON *COLEUS PARVIFLORUS* BENTH.

The genus *Coleus* contains species of both ornamental and economic value. The one most commonly cultivated in gardens is *C. blumei* Benth. of Javanese origin which is noted for its beautiful mottled leaves with deep purple and red pigments. There are many varieties of this species existing in cultivation, some of which are very high polyploids. The chromosome numbers reported for this species are  $2n = 24^1$  and  $2n = 48$  and  $72^2$ . Several other ornamental species have also been introduced from Central Africa.

Amongst the edible species of *Coleus* is *C. barbatus* Benth. the roots of which are pickled and eaten in Bombay State. Even more important as a cultivated plant in South India is *C. parviflorus* (Syn. *C. tuberosus* Benth.) commonly known in Tamil as "Koorgan kilangu" which is widely cultivated for its edible tubers. The plant is a small herbaceous annual with succulent stem and aromatic leaves, grown in Kerala during the monsoon. The plant is easy to propagate and needs very little attention, thriving well on sandy soil. A single tuber germinates within a fortnight giving rise to a cluster of sprouts. The top of the suckers with 4 to 5 leaves are nipped off and, planted in rows; these get established very quickly and in their turn give rise to a new set of suckers. By repeating the process large areas can be cultivated in a short period using the minimum seed material. The small blackish brown tubers are rich in starch and protein, have an aromatic flavour and are commonly used as a substitute for potato.

A survey of the tubers collected in Kerala showed much variation in size. Two distinct varieties were noted, one with small and the other with big tubers. These are being grown at the Central Botanical Laboratory as a possible new economic crop for Uttar Pradesh. Chromosome studies on these plants were made from the tubers grown in pots. Root-tips were pretreated with 8-oxyquinoline, and somatic squashes were made following the technique adopted by Tjio and Levan.<sup>4</sup>

The diploid number of the species which has been reported for the first time was found to

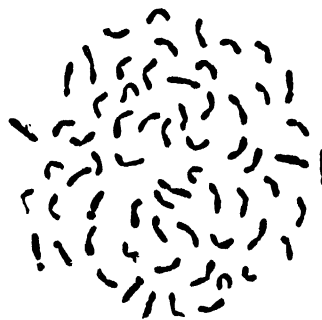

FIG. 1. Somatic chromosomes of *C. parviflorus* ( $2n = 64$ )  $\times 2,400$ .

be  $2n = 64$  chromosomes (Fig. 1). No difference was found in the chromosome numbers of the small and the big varieties. It is interesting to note that *C. aromaticus* Benth., another cultivated plant of medicinal value, has  $2n = 32$  chromosomes and a basic number of  $x = 8$ .<sup>3</sup> *C. parviflorus* has also the same basic number of  $x = 8$  and is thus a high polyploid.

Central Botanical Lab., R. SUNDARA RAGHAVAN.  
Botanical Survey of India,  
June 23, 1958.

1. Furusato, K., *Bot. & Zool., Tokyo*, 1940, **8**, 1303.
2. Reddy, N. S., *J. Hered.*, 1952, **43**, 233.
3. Scheel, M., *Bot. Arch.*, 1931, **32**, 148.
4. Tjio, J. H. and Levan, A., *Anales De La Estacion Experi. De Aula Dei.*, 1950, **2** (1), 21.

#### STEM ROOT OF *RAUWOLFIA* *SERPENTINA*

CERTAIN experimental trials on the vegetative propagation of *Rauwolfia serpentina* Benth. ex Kurz., were being conducted at the Morris Arboretum, Philadelphia, U.S.A., during September 1956. Among the trials with shoot-tip soft wood cuttings, it was noted that one batch of 3-week-old cuttings became thin at the region of the stem near the level of soil and began to rot at the affected part (Fig. 1).

The infected parts of the stem cuttings were removed, surface sterilised with 0.01% mercuric chloride for 1 min., washed in several changes of sterile water and plated out on standard

HEAD ORGAN PATTERNS OBSERVED  
IN SOME INDIAN FRESH-WATER  
DACTYLOGYRIDS; TREMATODA-  
MONOGENEA.



FIG. 1. Stem rot of *Kanikolpa serpentina* caused by *Rhizoctonia* sp.

potato-dextrose agar, when all the platings gave out *Rhizoctonia* sp.

Previously sterilised stem bits of *R. serpentina* of about 1" in length were buried in the infected soil and were subsequently removed and plated out on standard acidified potato-dextrose agar, after a period of 7 days. The following fungi were isolated from the stem bits thus plated: *Rhizoctonia* sp., *Rhizopus* sp., *Trichoderma* sp., *Fusarium* sp., *Aspergillus niger* and *Penicillium* sp.

Pathogenicity trials with the individual isolates, made with 21-day soil-oat inoculum, failed to cause the stem rot when freshly cut and healthy shoot-tip cuttings of *R. serpentina* were planted in the inoculated soil; except *Rhizoctonia* sp. which gave 80% infection causing stem rot. By plating out the infected stem cuttings, the pathogen, *Rhizoctonia* sp., was reisolated.

Thanks are due to Prof. Dr. John M. Fogg Jr., Director, The Morris Arboretum, Philadelphia, U.S.A., for his valuable advice and helpful criticism, and to Olin Mathieson Chemical Corporation, New York, for the award of a research grant.

The Morris  
Arboretum,  
Philadelphia-18, Pa.

P. D. VARADARAJAN.\*  
June 11, 1958.

CHARACTERISTIC glandular bodies occurring in the cephalic lobes of almost all members of the family Dactylogyridæ have been variously named by different authors as *cephalic bodies*, *anterior adhesive organs* or *adhesive organs*. Johnston and Tiegs<sup>10</sup> called them head organs. Later workers like Mizelle,<sup>11</sup> Mueller,<sup>12</sup> and Hargis<sup>1</sup> adopted the same term which is now in universal use.

The author (Jain<sup>3-9</sup>) used the same term while describing these organs in some Indian dactylogyrids. It appears that no attempt has so far been made to classify the various diverse patterns of head organs. The main difficulty has been that many old descriptions lack a clear diagram of these organs and almost all recent descriptions omit the diagram altogether.

During my investigation, however, it was possible to draw detailed diagrams and make a close study. Hargis<sup>2</sup> chloretone technique was used for the recovery of trematodes from the gill filaments of fishes. It gave the immediate advantage of getting fresh trematodes for study which are naturally more transparent.

The various types of head organs, I have come across, can be conveniently classified into two main groups: A—in which the head organs

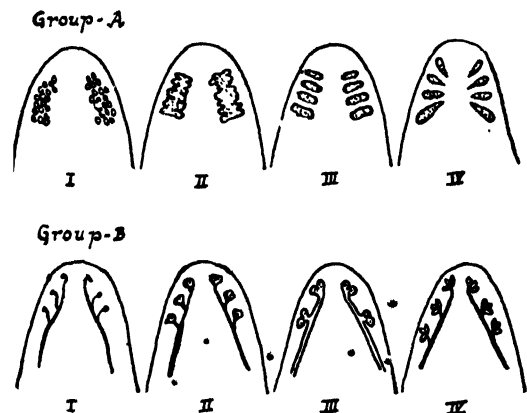

FIG. 1

do not communicate with each other, there being no duct or canal to join all organs of one side, and B—in which there are definite channels on either side, joining all the organs of that side. Each group, A and B, can be further subdivided into four main types, as follows:

\* Present address: Botanist, Sarabhai Chemicals, Ahmedabad.



TABLE I

Group	Type	Subfamily Dactylogyriinae	Subfamily Tetraonchinae
A	I	..	* <i>Urocleidus rhycolidelli</i>
	II	..	<i>Urocleidus nolopteri</i> Jain, 1955
	III	<i>Dactylogyrus multispiralis</i> Jain, 1957	* <i>Bifurcohaptor indicus</i>
	IV	<i>Neodactylogyrus cotius</i> Jain, 1957	<i>T'haparocleidus wallagonius</i> Jain, 1952 * <i>Urocleidus xenentodi</i>
B	I	..	* <i>Urocleidus vachius</i>
	II	..	* <i>Urocleidus polyspiralis</i>
	III	<i>Neodactylogyrus calbasi</i> Jain, 1957	<i>Mizelleus indicus</i> Jain, 1957
	IV	..	* <i>Bifurcohaptor giganticus</i>

\* Indicates the name of trematodes descriptions of which are still in press.

### Group A

I. *Disorganised* small rounded glands, perhaps most simple and primitive.

II. *Compact* organ on either side, with irregular margins, as if by fusion of smaller glands.

III. *Lobate* organs on either side. Each lobe divided into distinct lobules.

IV. *Specialised* lobes on either side. Each lobule in pair with definite shape: rounded distal end and sharp conical proximal end.

### Group B

I. *Primitive* small rounded glands, joined to a common duct on either side.

II. *Swollen sac-like* glands, filled with clear granular fluid, on either side, joined by common ducts.

III. *Double lobules* by a division of the main lobule, filled with granular fluid, joined to common ducts on either side.

IV. *Triple division* of the main lobule. Perhaps this is the most specialised pattern. It is found in the largest fresh-water tetraorchid, so far known.

In Table I are given the examples of each type of head organ pattern, together with subfamily, group and type.

The observations were made in the Zoology Department of Lucknow University, under supervision of Professor M. B. Lal, to whom my thanks are due.

Indian Statistical Institute, S. L. JAIN.  
203, B.T. Road,  
Calcutta-35, May 19, 1958.

1. Hargis, W. J. Jr., *Amer. Midl. Nat.*, 1952, **47**, 471-77.

2. —, *Jour. Parasit.*, 1953, **39**, 224-25.

3. Jain, S. L., *Ind. Jour. Helm.*, 1952, **4**, 113-18.

4. —, *Ibid.*, 1952, **4**, 119-24.

5. —, *Proc. Ind. Acad. Sci.*, 1955, **41**, 31-37.

6. Jain, S. L., *Ann. Zool.*, 1957, **2**, 57-64.

7. —, *Proc. Nat. Acad. Sci.*, 1957, **27**, 26-30.

8. —, *Ibid.*, 1957, **27**, 53-63.

9. —, *Jour. Parasit.*, 1958 (in press).

10. Johnston, T. H. and Tiegs, O. W., *Proc. Linn. Soc. N.S.W.*, 1922, **47**, 83-131.

11. Mizelle, J. D., *Ill. Biol. Monogr.*, 1938, **17**, 1-81.

12. Mueller, J. F., *Amer. Midl. Nat.*, 1938 **19**, 220-35.

### GARRA ETHELWYNNAE, A NEW CYPRINID FISH FROM ERITREA (AFRICA)\*

DIAGNOSIS: A *Garra* attaining a standard length of 28.0 mm.; with smooth snout, two pairs of barbels and the back, chest and belly naked. There are 32 to 34 scales in lateral line. The vent is situated very near the origin of the anal fin. The air-bladder is well developed. The colour is dark grey above, paler beneath with a broad lateral band along the middle of the side.

Range.—Salamona, Eritrea (Africa).

Description.—(Text-Fig. 1): Depth of body 3.51 (3.11-3.91) in standard length, length of head 3.53 (3.50-3.58). Width of head 1.29 (1.20-1.33) in length of head, height of head 1.29 (1.20-1.33). Pupil of eye a little in front of the middle of the length of head. Inter-orbital region flat. Snout rounded, smooth, 2.58 (2.40-2.67) in length of head, diameter of eye 3.40 (3.00-4.00), inter-orbital width 1.99 (1.71-2.28). Two pairs of barbels smaller than diameter of the eye. Nine outer gill-rakers in the lower part of the anterior arch. Mental disc well developed. Length of disc 3.40 (3.00-4.00) in length of head, width 2.33 (2.00-3.00) in width of head; length of disc 1.15 (1.00-1.25) in its own width. Thirty-two to thirty-four scales in lateral line, 4.5 from the origin of dorsal to lateral line, 3.5 or 4.5 between

this and pelvic. Back, chest and belly naked; post-pelvic region scaly. Dorsal 111, 7; distance between its anterior origin and tip of snout 1.82 (1.79-1.87) in standard length. Length of pectorals 1.29 (1.20-1.33) in length of head. Distance between anterior origins of pelvic and anal fins 1.99 (1.80-2.08) in that between anterior origin of pelvic and base of caudal fin. Anal 11, 5. Distance from vent to anal fin 9.33 (6.00-12.00) in that between anterior origins of pelvic and anal fins. Length of caudal peduncle 1.85 (1.78-2.00) in length of head, width 1.15 (1.12-1.20) in its own length.

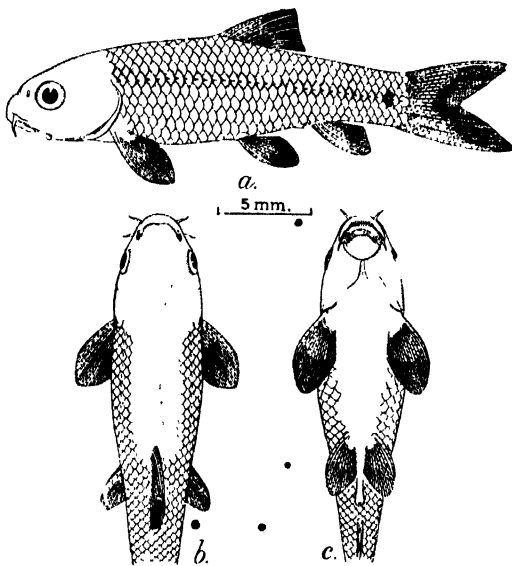

TEXT-FIG. 1. *Garra ethelwynna* Menon (sp. nov.).  
a. Lateral view of paratype (Z.S.I. Reg. No. F 859/2).  
b. Dorsal view of the same.  
c. Ventral view of the same.

Posterior chamber of air-bladder measured in one specimen 25.0% in standard length.

Colour, in alcohol, dark grey above, paler beneath, a broad lateral band from gill openings to the base of the caudal fin and a black spot at the upper angle of the gill openings.

**Holotype.**—In British Museum (Natural History), London, Reg. No. 1950.5.31.19; Salama, Eritrea, standard length 28.0 mm., donated by the Sudan Museum (D. J. Lewis).

**Paratypes.**—One in British Museum (Natural History), London, taken along with the holotype and bearing the same data, standard length 28.0 mm., one bearing the same data as the holotype in the Zoological Survey of India, Calcutta, Reg. No. F 859/2, standard length 21.5 mm.

**Relationships.**—In my taxonomic monograph on *Garra* which will be published soon in the *Memoirs of the Indian Museum*, *G. ethelwynna* is placed under the *tibanica*-complex of species. The members of this complex exhibit 9 to 11, rarely 12 outer gill-rakers on the lower part of the anterior arch, a well developed air-bladder, a row of dark spots at the base of the branched dorsal rays, and a broad dark band from behind the gill openings to the base of the caudal fin. Included in this complex are *tibanica*, *quadrifaculata*, *ignestii*, *ornata*, *trewavasi*, *makiensis*, *dcembeensis* and *ethelwynna*. Their distribution is now at or towards the western extremity of the range of the genus apparently because they are evolutionarily very old and probably an early stock given off from the evolutionary centre of the genus in South-East Asia.<sup>1,2</sup> *G. ethelwynna* is a dwarf cognate of *G. tibanica*<sup>3</sup>; the scaleless nature of the back, chest and belly, however, easily distinguish it.

Zoological Survey of India, A. G. K. MENON.  
Calcutta, May 24, 1958.

\* Published with the kind permission of the Director, Zoological Survey of India, Calcutta.

1. Annandale, N., *Rec. Indian Mus.*, Calcutta, 1919, **18**, 67-78, pls. ix-xi.
2. Hora, S. L., *Ibid.*, Calcutta, 1921, **22**, 633-87, pls. xxiv-xxvi.
3. Trewavas, E., "Expédition to South-West Arabia, 1937-38. Fresh-water fishes," *British Museum (Natural History)*, London, 1941, **1**, 7-15.

#### THE FREE AMINO NITROGEN CONTENT AS AN INDEX OF QUALITY OF ICE-STORED PRAWNS

OBJECTIVE tests which are useful for assessing the number of days elapsed in ice storage and/or which reflect the early changes occurring in prawns before the onset of spoilage are essential for quality control in the prawn processing industry. Our earlier findings<sup>1</sup> that the free amino nitrogen content of the crustacean muscle is over 300 mg. N/100 g. of muscle whereas it is only about 1/10th of this value in the fishes suggested that the determination of amino nitrogen might be of use in studies on crustacean spoilage. Hence this determination was included among other chemical and bacteriological tests in investigations on the quality of ice-stored prawns which are in progress at this Station. The results of one series of observations on prawns obtained at Mandapam and also on prawns landed at Cochin on the West Coast are shown in Figs. 1 and 2.

It is seen that the decrease in amino nitrogen is more regular than the decrease in the orthophosphate which shows some scattering. Also there is close agreement in the amino nitrogen values of the Mandapam prawns and Cochin prawns after equal periods of storage in ice. Bailey *et al.*<sup>2</sup> did not include amino N among the tests which show definite changes in the prime quality of ice-stored prawns but considered it among other tests for judging the relative quality. Our observations on prawns comprising of different species\* and taken from different environs indicate that definite ranges of amino N values are associated with the number of days in ice storage. Values of over 200 mg. N/100 g. characterise the first two days, values between 100 and 200 mg. the next three or four days and values below 100 longer durations. According to Bailey *et al.* (*loc. cit.*) the prime quality phase of ice-stored prawns lasts for about six days. The rapid decrease in amino N is seen to be arrested about the sixth or seventh day (Fig. 1). It appears therefore that

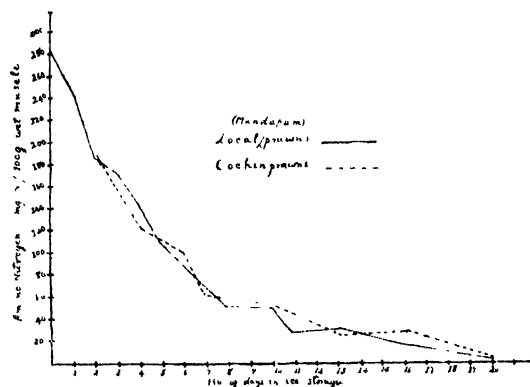

FIG. 1. Decrease in amino N during ice storage.

the amino N is also useful as the other tests mentioned by Bailey *et al.* The determination of amino N by the method employed<sup>3</sup> is simple, accurate and needs no special equipment or instruments.

Campbell and Williams<sup>4</sup> had reported an increase in the amino N in Gulf coast shrimps during ice storage; but Fieger and Friloux<sup>5</sup> observed a decrease in the amino N. Our observations are in agreement with those of the latter workers; however, the fall in amino N is more rapid and much lower values are reached after two weeks' storage in ice in our experiments. The reason for this is, not clear at present. The initial amino N values for Gulf coast shrimps reported by Fieger and Friloux are of the same level as in Indian prawns, crabs and lobsters reported by us (*loc. cit.*).

Bailey *et al.* attributed the differences in their observations and those of Campbell and

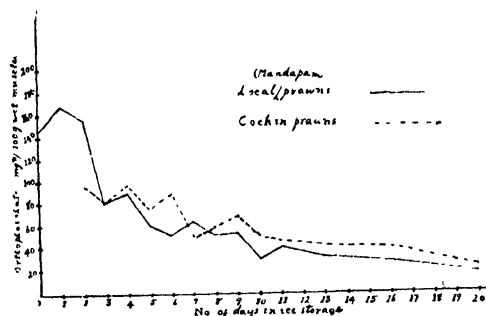

FIG. 2. Decrease in orthophosphate during ice storage.

Williams to possible differences in the bacterial flora. The mechanism of the decrease in the amino N during ice storage is not clearly elucidated yet; but experiments carried out by us have shown that leaching by contact with melting ice is the most significant factor. Bacterial action is not probably involved since the bacterial population is low especially during the early days of storage when the decrease in amino N is most rapid. The loss of free amino acids by leaching may itself contribute to a lessening in the flavour of the prawn meat. The full investigations will be reported later.

We wish to express our thanks to Dr. S. Jones, Chief Research Officer, for encouragement and permission to publish this note.

Central Marine Fisheries Research Station, Mandapam Camp, June 5, 1958.  
N. K. VELANKAR.  
T. K. GOVINDAN.

\* The Mandapam prawns consisted entirely of *Penaeus indicus* and the Cochin prawns of *Metapenaeus dobesii*, *M. affinis*, *M. monoceros* and *P. indicus*, the first being predominant.

1. Velankar, N. K. and Govindan, T. K., *Proc. Ind. Acad. Sci.*, 1958, **47B** (4), 20.
2. Bailey, M. E., Fieger, E. A. and Novak, A. F., *Food Research*, 1954, **21** (6), 611.
3. Pope, C. G. and Stevens, M. F., *Biochem. J.*, 1939, **33**, 1070.
4. Campbell, L. L. and Williams, O. B., *Food Technol.*, 1952, **6**, 125.
5. Fieger, E. A. and Friloux, J., *Ibid.*, 1954, **8**, 35.

#### THE VISITS OF INSECTS TO DIFFERENT COLOURED FLOWERS OF *LANTANA CAMARA* L.

*Lantana camara* L. exists in two varieties, one in which the flowers contain yellow pigment, and the colour changes from yellow to orange as red pigment develops, the other in which yellow pigment is absent, and the flower colour changes from white to pink. I hope to investi-

gate the genetics of this difference. Meanwhile, as mixed populations are very common, it seemed worthwhile to find out whether mating was at random in nature. From 29th May to 5th June 1958, I watched three plants with yellow pigment and three without it in the morning from 8 a.m. to 9 a.m. The only insects seen visiting the flowers were the Lepidopteran species *Precis almana* L. and *Catopsilia pyranthe pyranthe* L. I often noticed that more than one of the latter species visited the plants at a time.

TABLE I  
Numbers of insect visits to flowers of  
*Lantana camara* L.

Butterfly	No. of visits to red-yellow flowered plants	No. of visits to white-pink flowered plants
I <i>Precis almana</i> L. ..	12	0
II <i>Catopsilia pyranthe pyranthe</i> L.	2	25

The numbers of visits are given in Table I. With two exceptions, each species remained true to one variety.\* In so far as these species carried pollen from one flower to another the two varieties were almost endogamous. It is of course possible that at other times of year there may be much more crossing. However, if one of the two varieties of *Lantana camara* L. is recessive to the other, a population must contain much fewer heterozygotes than the number calculated if matings were at random.

There is plenty of evidence<sup>2,3</sup> that a Lepidopteran species may prefer one colour to another, and that this preference varies between species. And there is evidence<sup>4</sup> dating back for over 2,000 years that insects distinguish between different species. So far as I know, however, this is the first evidence that two different insect species each prefer one of two varieties of the same plant species. The observation has several interesting evolutionary consequences. The relative abundance of the two insect species might determine the relative abundance of the two colour varieties in a given area and perhaps conversely. And selection by insect pollination offers a possible method by which one species could give rise to two species.

I am thankful to Dr. H. Spurway for valuable criticism and advice. My sincere thanks are also due to Dr. A. P. Kapur of Zoological Survey of India, for the identification of one of the butterflies; to Professor J. B. S. Hal dane, F.R.S., for suggestions and helpful inter-

est and to Professor P. C. Mahalanobis, F.R.S., Director, Indian Statistical Institute, for the facilities I enjoyed during the work.

KRISHNA R. DRONAMRAJU.

Biometric Res. Unit,  
Indian Statistical Institute,  
Calcutta-35, July 7, 1958.

\* Fisher's<sup>1</sup> exact method shows that the probability that this selectivity in visiting should be due to chance is  $2.327 \times 10^{-8}$ .

1. Fisher, R. A., *Statistical Methods for Research Workers*, 1948, Oliver & Boyd, London.
  - †2. Ilse, D., *Ueber den Farbensinn der Tagfalter*. *Zeitschr. Wiss. Biol. Abl. C. Zeitschr. Vergl. Physiol.*, 1928, 8 (3/4), 658-92.
  - †3. —, *Ueber den Farbensinn der Tagfalter*. *Forsch. u. Fortschr.* (Berlin), 1929, 5 (34), 397-98.
  4. Darwin, C., *The Effects of Cross and Self-fertilisation in the Vegetable Kingdom*, Murray, London, 1876.
- † Seen in the abstract form.

A NOTE ON THE EXTERNAL  
ANATOMY OF *PRECIS ORITHYA*  
SWINHØE (NYMPHALIDAE:  
LEPIDOPTERA)

*Precis orithya* Swinhøe, a butterfly commonly known as the 'Blue Pansy' in view of the resemblance of its wing pattern to that flower, has been recorded breeding on *Striga euphrasioides*, a weed parasitic on the roots of sugarcane. It appears in the field as early as May and is most active between July and October, after which with the onset of winter its population decreases rapidly. It overwinters as an adult. Agarwala and Naqvi<sup>1</sup> have studied its bionomics and natural parasitism as well as its alternate host plants by carrying out exhaustive starvation tests. In this note a brief account of the external anatomy of its various stages is presented.

*Egg*.—Small, aethalia, acorn-shaped, light green in colour with 15 longitudinal flanges or keels.

*Larva*.—Thin, long, cylindrical, measuring on an average 1.5 mm. in length when freshly hatched and 25 mm. when full grown.

Head capsule dark brown in colour, conspicuously two-humped, having a pair of scoli; carries a large number of bristles (Fig. 1). Vertex cut out by the posterior emargination of the dorsal wall of the cranium. Antennæ very small, 3-segmented, situated on the anterior edges of the epicranials. Ocelli, six on each epicranial plate, three on dorsal side and three on latero-ventral side. Frons extremely modified and transformed into an inverted Y-shape by the upward growth of clypeus into its

ventral part; the stem of Y sunken into the head by a median invagination of the head wall above the apex of the clypeus, and the arms of the Y (adfrontals) forming narrow strips between the clypeus and parietals.

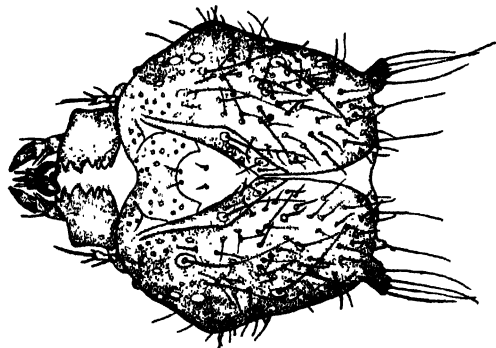

FIG. 1. Head capsule.

Thorax and abdomen sooty black in colour covered with sharp and complex spines and bristles borne on 9 longitudinal rows of pointed scoli. Scoli well developed, each bearing a number of setæ. Four pairs of prolegs and a pair of claspers present; crochets multiordinal arranged in meso-series forming incomplete circles; five pairs of indistinct, elongated oval spiracles.

*Pupa*.—Obtect, angular with sharp projections, brown to dark brown in colour, suspended by the tail hook or cremaster (head down) without any silk girdles.

*Imago*.—Median-sized butterfly with only two pairs of functional legs (both sexes), forelegs being rudimentary, held up against the body; the palpi clearly articulated, the last joint being pointed. Antennæ slender, clavate, dilated apically forming a gradual rounded club, gray in males and dark in females. Eyes smooth.



FIG. 2. Fore wing.

Wings strong, with an expanse of 42 mm. on an average. Venation in fore and hind wings distinctly different, with no distended veins. Forewing  $1\frac{3}{4}$  times longer than broad with 12 distinct veins (Fig. 2); Cu 2 absent and only one anal vein 1A present. Hind wing rounded, shaped like the ear of an elephant (Fig. 3),



FIG. 3. Hind-wing.

with length  $1\frac{1}{2}$  times more than breadth; frenulum absent; discal cell open; 10 distinct veins; Sc present, Sc + R 1 arising from near the base; Cu 2 absent; two anal veins—2A very small and strongly curved.

Sincere thanks are due to Mr. K. L. Khanna, Director, Sugarcane Research and Development, Bihar, Pusa, for kind encouragement and providing the necessary facilities.

Sugarcane Entomologist, DHAMO K. BUTANI,  
Sugarcane Res. Institute,  
Bihar, Pusa, April 22, 1958.

1. Agarwala, S. B. D. and Naqvi, S. Z. H., *Proc. Bihar Acad. Agri. Sci.*, 1953, 2, 120-24.

#### MOLYBDENUM REQUIREMENT OF *SELENASTRUM WESTII* IN TERMS OF ATOMS PER CELL

EVER since Steinberg<sup>7</sup> demonstrated the indispensability of molybdenum and a progressive increase in the weight of the mycelium of *Aspergillus niger* with the increasing concentrations of this element when nitrate is provided as the sole source of nitrogen in the medium, sufficient evidences have been accumulated for a molybdenum requirement by other organisms<sup>2,3,6,8</sup> as well as by higher plants.<sup>1</sup> A critical study has been made recently with special reference to the molybdenum requirement of *Chlorella pyrenoidosa*<sup>6,8</sup> and *Scenedesmus obliquus*<sup>2,3</sup> both belonging to the order Chlorococcales. The present communication reports the molybdenum requirement of *Selenastrum*

*westii*, another member belonging to the same order, *Chlorococcales*.

Chu 10 solution<sup>7</sup> supplemented with Chu's micronutrient solution was used as the basal medium and the iron source in the original medium was replaced by 5 p.p.m. of iron as ethylene diamine tetra acetic acid (Fe-EDTA) and the pH of all the cultures was adjusted to 7.5. Various amounts of molybdenum (as sodium molybdate) were provided to the individual cultures giving a final concentration of 0.001, 0.01, 0.1 and 1 ppb. Mo, while in the control cultures this element was completely omitted. All the cultures were grown under identical conditions under continuous illumination provided by six 3' 40 watts fluorescent tubes and the culture vessels were inoculated at the rate of  $2 \times 10^{10}$  cells per litre. For growth measurements, aliquots were removed daily and the cell counts were made in a haemocytometer. The results are expressed in Fig. 1.

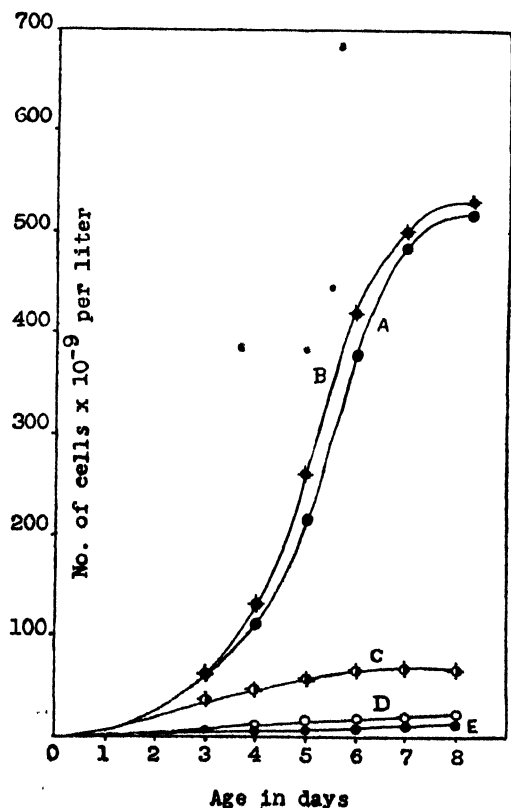

FIG. 1. Growth curves of *Selenastrum westii* at different molybdenum concentrations. (Curves A, B, C, D and E at 1, 0.1, 0.01, 0.001 ppb. Mo and minus Mo respectively.)

It is seen from Fig. 1 that in the medium without any added molybdenum (control) the

growth is almost nil (curve E) and 0.001 ppb. Mo also is found to be quite insufficient for the normal growth of the alga (curve D). Although there is perceptible growth in 0.01 ppb. Mo, from the curve C it appears that the element soon becomes insufficient and acts as a limiting factor after about 6 days of growth, while 0.1 ppb. Mo proves to be quite adequate for a good growth (curve B) during the experimental period. At still higher concentrations (1 ppb. Mo) there seems to be a slight retardation in the growth rate as seen from the curve A, thereby showing a slight inhibitory effect on the growth rate at a concentration higher than 0.1 ppb. Mo in the medium.

The understanding of the adequate and toxic levels of this element gives a clue to the requirement of molybdenum by the alga in terms of atoms-Mo per cell. The values of atoms-Mo were calculated from Fig. 1, on the assumption that all the molybdenum supplied to the medium have been used up by the alga and consequently the figures given in Table I represent the maximum values. Net cell counts which represent the growth of the alga as the function of molybdenum concentration were calculated by subtracting the number of cells in the minus molybdenum culture (*Blank*) from the number of cells in the media provided with different concentrations of molybdenum. The requirement of atoms molybdenum per cell is computed both at the restricted and adequate levels of molybdenum concentration by the formula  $g/n \times N$ , where  $g$  represents the gram-atoms Mo,  $n$ , the net cell count and  $N$ , the Avagadro's number.<sup>3</sup> The calculated values are given in Table I.

TABLE I

Showing the number of molybdenum atoms per cell of *Selenastrum westii*

Age in days	Concentration of Mo in ppb.					
	0.001		0.01		0.1	
	Net cell count $\times 10^{-9}$	Atoms-Mo per cell	Net cell count $\times 10^{-9}$	Atoms-Mo per cell	Net cell count $\times 10^{-9}$	Atoms-Mo per cell
3	4	1600	35	1800	60	10,400
4	5	1200	45	1400	130	4,800
5	6	1000	55	1100	260	2,450
6	8	960	65	960	420	1,500
7	8	960	65	960	500	1,200
8	8	960	65	960	530	1,200

In all the cultures, both with restricted and adequate supply of molybdenum, the rapid growth phase is observed when the concentration of molybdenum was above approximately 1,200 atoms per cell and a drop in the molybdenum atoms level below 1,000 atoms per cell results in the cessation of the growth in the series with restricted supply of molybdenum (0.001 and 0.01 ppb. Mo) and in the series with adequate supply the growth rate appreciably decreases with a decrease in the molybdenum level per cell. To ensure good growth of *Selenastrum*, about 1,500 atoms-Mo per cell are required and cell division ceases when the supply of molybdenum falls below this level.

On comparison with *Azotobacter*<sup>4</sup> and *Scenedesmus obliquus*,<sup>3</sup> *Selenastrum westii* has a very low molybdenum requirement and this substantiates the catalytic role of this trace element in the general metabolism of this alga. Further, the inhibitory level of molybdenum concentration for *Selenastrum westii* is much less than that for *Scenedesmus*.<sup>3</sup> It is also observed that in the molybdenum-deficient cultures, the material accumulates abundant starch and the cell division also is considerably arrested. The low levels of molybdenum concentration (0.001 and 0.01 ppb. Mo) at which such deficiency symptoms are noted are in close agreement with higher plants<sup>1</sup> and *Scenedesmus obliquus*.<sup>3</sup>

In conclusion, we record our sincere thanks to Dr. M. S. Randhawa, Dr. B. P. Pal and Dr. S. M. Sikka for their keen interest and encouragement throughout the investigation.

Algal Lab., G. S. VENKATARAMAN.  
Botany Division, K. V. NATARAJAN.  
I.A.R.I.,  
New Delhi-12, May 26, 1958.

1. Agarwala, S. C. and Hewitt, E. J., *J. Hort. Sci.*, 1954, **29**, 278.
2. Arnon, D. I., *et al.*, Paper presented before Amer. Soc. Plant Physiol. Madison, Wisconsin, Sept. 1953.
3. —, *Physiol. Plantarum*, 1955, **8**, 538.
4. Burk, D., *Ergebn. Enzymforsch.*, 1934, **3**, 23.
5. Chu, S. P., *J. Ecology*, 1942, **30**, 284.
6. Loneragan, J. F. and Arnon, D. I., *Nature, Lond.*, 1954, **174**, 459.
7. Steinberg, R. A., *J. Agr. Res.*, 1935, **55**, 891.
8. Walker, J. B., *Arch. Biochem. & Biophys.*, 1953, **46**, 1.

### PRELIMINARY LIST OF HELMINTH PARASITES OF DONKEY (*EQUUS ASINUS*)

THE occurrence of a large number of helminth parasites has been widely recorded from horse, donkey and mule, but of these equines, horse alone appears to have received so far some attention in this country. Bhalerao (1935) recorded four species of worms, *viz.*, *Schistosoma indicum*, *Anoplocephala magna*, *A. perforata* and *Parascaris equorum* from ass or donkey. In his classified list of hosts, Baylis (1936) mentioned under horse, donkey and mule, 33 species of nematodes, and in dealing with the various species, he invariably observed that these parasitise, horse, donkey, mule and zebra, but in no case has donkey been specifically mentioned as a host. The accounts of the species incorporated by Baylis are based on the records and observations of Boulenger (1921) and Gaiger (1910 and 1915) who have recorded the species from horses in the Punjab. From South India, Mudaliar and Alwar (1947) have listed a large number of species of nematodes from horse, but there appears to be only one record of helminth parasite from donkey, *viz.*, *Ascaris equorum*.

During routine collection of helminth parasites from domesticated animals, an opportunity was afforded to collect the common representative species from donkey in addition to those collected from horse. Three animals were examined in which 2 species of trematodes, 2 of cestodes and 19 species of nematodes were encountered. After identification and perusal of the literature available it appears that to the four species so far recorded from donkey, we have a fairly large number of species to add. Following are the species which are recorded for the first time from this country in donkey.

*Pseudodiscus collinsi* Cobbold, 1875; *Anoplocephala mamillana* (Mehlis, 1831); *Oxyuris equi* (Schränk, 1788, E. Blanchard, 1849); *Strongylus (Delafondia) vulgaris* (Looss, 1900); Skrzabin, 1935—heavy infestation with aneurisms in anterior mesenteric artery; *Triodontophorus serratus* (Looss, 1900, 1902); *Triodontophorus brevicauda* Boulenger, 1916; *Triodontophorus minor* (Looss, 1900, 1902); *Trichonema longibursatum* Yorke and Macfie, 1918; *Trichonema calicatum* (Looss, 1900); *Trichonema (Cylicostomum) ægyptiacum* Railliet, 1923; *Trichonema (Cylicocyclus) insigni* (Boulenger, 1917); *Trichonema (Cylicocercus) pateratum* (Yorke and Macfie, 1919); *Trichonema (Cylicocercus) goldi* (Boulenger, 1917); *\*Trichostrongylus axei* Cobbold, 1879; *Dictyo-*

*caulus arnfeldi* (Cobbold, 1884) Railliet and Henry, 1907; *Habronema muscae* (Carter, 1861), Diesing, 1861; *Habronema microstoma* (Schneider, 1866), Ransom, 1911; *Habronema megastoma* (Rudolphi, 1819);—heavy infestation with a big-sized tumor; *Gongylonema pulchrum* (Molin, 1857)—in wall of oesophagus and stomach; *Setaria equina* (Abildgaard, 1789)—Railliet and Henry, 1911.

The authors are grateful to Dr. B. P. Pande for his guidance and for going through the manuscript. Thanks are due to Sri. C. V. G. Choudary for the facilities provided.

Dept. of Parasitology, P. RAI.  
U.P. College of Veterinary J. S. SRIVASTAVA.  
Science and Animal  
Husbandry, Mathura,  
Uttar Pradesh, May 12, 1958.

\* First Report in Equines from India.

1. Baylis, H. A., *Nematoda I and II*, 1936-1939, 408, 274.
2. Bhalerao, G. D., *I.C.A.R. Scientific Monograph* No. 6, 1935, 365.
3. Lapage, G., *Monning Veterinary Helminthology. Entomology*, IV ed., 1956, 511.
4. Mudaliar, S. V. and Alwar, V. S., *Indian Veterinary Journal*, 1947, 24, 77-94.
5. Southwell, T., *The Fauna of British India. Cestoda II*, 1930, 262.
6. Yorke, W. and Maplestone, P. A., *The Nematode Parasites of Vertebrates*, 1926, 536.

## CYTO-GENETIC STUDIES IN INDIAN SILKWORMS

### I. Preliminary Observations on Spermatogenesis in Castor Silkworm, *Attacus ricini*

CASTOR silkworms provide one of the major cottage industries in certain parts of India. The unreelable cocoons yield fibre which, compared to mulberry silk, is less lustrous but much stronger and durable. Extensive cytological and genetic work has been done on the mulberry silkworm, *Bombax mori*, particularly in Japan (Tanaka, 1953). From the recent review by Makino (1953), the genus *Attacus* does not appear to have been cytologically investigated. In view of the industrial importance of the castor silkworm of India, various species of *Attacus* have been taken up for cytogenetic investigation in this laboratory. Some preliminary observations on the spermatogenesis have been presented here.

Examinations at late larval and early pupal stages revealed that various stages of spermatogenesis occur during first four to five days of pupal stage after completion of cocoons. Pupal testes were dissected, smeared and fixed in Navashins fluid, rinsed in water and stained

with crystal violet. Camera lucida drawings were made at bench level with 100× oil immersion and 25× compensating eyepiece. Photomicrographs were taken at 1000× magnification.

During early diplotene paired chromosomes show well-defined primary constrictions. Two large pairs show distinct satellites, one having sub-median and other a median constriction. Shorter pairs show two terminal chiasmata and the longer ones have both interstitial and terminal chiasmata. Terminalisation is complete at late diakinesis. Metaphasic orientation is equidistant and does not suggest any secondary associations. No multivalent associations occur there being regular 14 bivalents. Two of these bivalents are comparatively larger, two smaller and remaining ten bivalents have more or less uniform size. (Figs. 1 to 5 and photomicrographs).

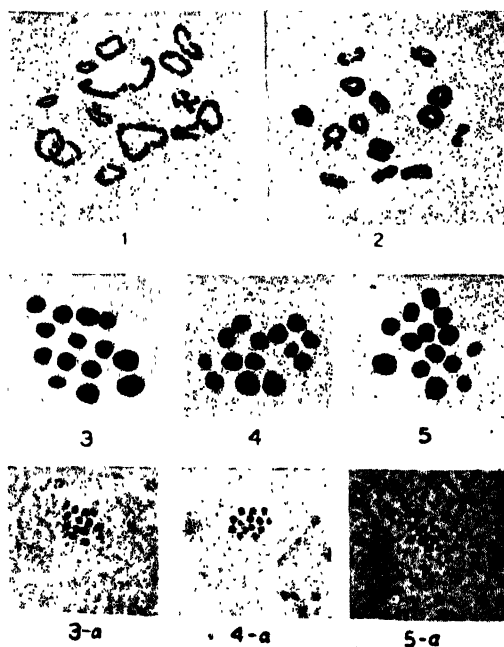

Spermatogenesis in *Attacus ricini*.

FIGS. 1 and 2. Diakinesis, FIGS. 3, 4, 5. Metaphases, all reduced to 1800× approx.

Photomicrographs 3-a, 4-a, 5-a, corresponding with FIGS. 3, 4 and 5 respectively showing metaphases with 14 bivalents, reduced to 720× approx.

The foregoing observations reveal that (1) *Attacus ricini* has its chromosome number as  $n = 14$  and  $2n = 28$ , (2) in view of regular bivalent formation, it seems to have typical diplotene constitution, (3) in view of presence of chiasmata during spermatogenesis, genetic crossing over in the male is indicated as in *Bombax mori*.



These observations are being critically pursued further. In view of the common basic number 14, both in *A. ricini* ( $2n = 28$ ) and in *B. mori* ( $2n = 56$ ) any possibilities of their phylogenetic interrelations are being investigated.

Thanks are due to Shri S. G. Shende for certain facilities, and Shri C. S. Bhambure and Shri S. R. Salvi for valuable help in the laboratory.

Silkworm Res. Station, G. B. DEODIKAR.  
Village Industries Board, C. V. THAKAR.  
Bombay State,  
Govt. Bungalow No. 1,  
Mahabaleshwar,  
Dist. Satara North (India),  
June 23, 1958.

1. Makino, S., *An Atlas of the Chromosome Numbers in Animals*, Iowa State College Press, Ames, 1953.
2. Tanaka, Y., "Genetics of the Silkworms *Bombax mori*" *Advances in Genetics*, Academic Press, New York, N.Y., 1953, 5, 239-317.

#### INHERITANCE OF SPOT-VARIATION IN *EPILACHNA* (COLEOPTERA : COCCINELLIDAE)

Two species of *Epilachna* beetles, 12 spotted (*Epilachna doëcastigma* Muls.) and 28 spotted (*Epilachna viginti-octopunctata* Fabr.), are the regular pests of vegetable crops in Bihar. While studying their life-history and biology, spot variations were observed on the elytra of these beetles. It was, therefore, considered worthwhile to investigate the factors which control spot-variation.

The phenomena of spot-variations have caused a lot of confusion in literature for identification work. On the basis of spot-variations, Chopra (1925) reported five species of *Epilachna*, viz., 12 spotted, 16 spotted, 24 spotted, 26 spotted and 28 spotted. Kapur (1950) stated that the identification of *Epilachna* spp. had become difficult on account of spot-variation. Wesley (1956) carried out studies on spot-variation and concluded that 12 spotted and 28 spotted are one species and designated it as 12-28 *Epilachna* sp.

Stock-culture of the *Epilachna* sp. was maintained on the leaves of potato, tomato and brinjal in glass bottles (10 cm. high and 9 cm in diameter) with perforated lids. During summer months, a layer of sand 2" thick was placed at the bottom and was kept moist by sprinkling water on the sand layer. Fresh leaves were renewed each day. This breeding technique

helped considerably for rearing the insect successfully under indoor conditions.

**Results.**—(1) The population studies of the *Epilachna* beetle brought to light three pertinent biological facts: (a) the 12 spotted beetles were found to outnumber the 28 spotted, (b) 12 spotted and 28 spotted were always found in close association on plants, and (c) nine types of spot variants (12 spotted, 14 spotted, 16 spotted, 18 spotted, 20 spotted, 22 spotted, 24 spotted, 26 spotted and 28 spotted) were observed. These facts indicated the possibility of cross-breeding between 12 spotted and 28 spotted beetles in nature.

(2) The 12 spotted and 28 spotted beetles were, therefore, isolated and were inbred. The pure inbred races of 12 spotted and 28 spotted were established when inbreeding was practised for six successive generations.

(3) The crosses between the inbred lines of 12 spotted females and 28 spotted males were carried out successfully. The progeny of first generation of the cross yielded nine spot-variations (12 spotted, 14 spotted, 16 spotted, 18 spotted, 20 spotted, 22 spotted, 24 spotted, 26 spotted and 28 spotted). In case of reciprocal cross between 12 spotted and 28 spotted, the females laid eggs, but they failed to hatch. This inviability of eggs may be due either to incompatibility between 12 spotted males and 28 spotted females or to environmental factors. The factors which account for inviability of eggs are still under investigation.

The nine types of spot variants obtained as a result of crossing between 12 spotted and 28 spotted agree with those observed in the field. It seems, therefore, that the nine groups of *Epilachna* beetles are not different species but are variants out of cross-breeding between 12 spotted and 28 spotted in nature. Spot-variations due to cross-breeding between the two related species of *Epilachna* have not been recorded before.

The authors wish to express their deep sense of gratitude to Dr. R. H. Richharia, Principal, for suggesting the problem and providing necessary facilities in the Post-Graduate Laboratory for carrying out the investigation.

Division of Entomology, B. S. LALL.  
Bihar Agric. College, S. C. MANDAL.  
Sabour, June 2, 1958.

1. Chopra, R. L., "Annual Report of Entomologist to the Government of Punjab, Lyallpur, for the year 1925-26," *Report, Dept. of Agric. Punjab* 1925, 1, 101.
2. Kapur, A. P., *Bull. Ent. Res.*, 1950, 41, 161-208.
3. Wesley, W. K., *Allahabad Farmer*, 1956, 30, 167-69

---

---

## REVIEWS

---

---

**X-Ray Microscopy and Microradiography.**  
(Proceedings of a Symposium held at the Cavendish Laboratory, Cambridge), 1956. Edited by V. E. Cosslett, Arne Engström, H. H. Pattee, Jr. (Academic Press, Inc., New York), 1957. Pp. 645. Price \$ 16.50.

The Symposium under review contains 66 separate, but interrelated accounts of progress in the use of X-rays for microscopy, micro-chemical analysis and microdiffraction. There are extensive discussions of tools and techniques as well as of applications and results in chemistry, biology, medicine and metallurgy.

The low wavelength and high penetrating power of X-rays have for long held out the promise of utilisation in high resolution microscopy. In principle, the simplest way of using X-rays for microscopy is to produce a sharp X-ray shadow of the specimen on a photographic film and to magnify the shadow in an optical or electron microscope. In order to attain high resolution, this method of radiographic microscopy requires the construction of special X-ray tubes (fine focus and soft radiation) and the employment of special cameras. Several descriptions of such apparatus are given. The use of curved mirror systems in making true reflection X-ray microscopes is extensively discussed. Some new ideas in X-ray microscopy, based on image scanning, the synthesis of wavefronts diffracted by X-rays, etc., are presented. It is clear from all this that X-ray microscopy has gone a long way since the pioneering experiments of Kirkpatrick and colleagues. A resolution of  $1\mu$  is now readily attained, while  $1000\text{ \AA}$  or better is in sight.

The differential absorption of X-rays and the emission of characteristic radiation of different wavelengths by various elements are now being increasingly used for microchemical analysis in the fields of biology, medicine, geology, metallurgy, etc. Detailed accounts of these applications and of some of the results obtained are given.

Other topics discussed include tubes and cameras suitable for micro-diffraction, the use of electronic computers in figuring the contours of reflecting surface, etc.

The Symposium is, of course, written in the language of communication between special-

ists. However, many of the contributions can be read with profit by any X-ray worker. The editorial standard and the general get-up are excellent.

T. RADHAKRISHNAN.

**Aircraft Hydraulics, Vol. II. (Component Design.)** (Chapman & Hall, London, W.C. 2; India: Asia Publishing House, Bombay-1), 1957. Pp. x + 198. Price 45 sh.

This book is the second in the series of two volumes on Aircraft Hydraulics published under the auspices of the Royal Aeronautical Society. It consists of eight chapters written by different authors and edited by Mr. H. G. Conway.

The first chapter is on seals and contains a useful account on the various aspects of the design of seals. The second chapter is on hydraulic pumps and motors. The treatment here is sketchy and is more likely to be of use to the specialist rather than for a young engineer trying to design pumps or motors. The third chapter is on jacks and contains much information useful to the designer.

Selectors and Miscellaneous components are treated in chapters four and six respectively. Miscellaneous components include, among other things, details on accumulators, tanks, filters etc. Illustrations of standard designs from one of the manufacturers is given and attention is drawn to some of the salient features. In fact, this feature is common to most of the material treated in this book. Chapter five on valves is fairly exhaustive and should be of considerable use to the hydraulic systems designer. Chapter seven contains an excellent introduction to hydraulic servo-controls without delving into the mathematical details of servomechanism theory. The last and eighth chapter is on pipework and gives simple rules for selection and layout of pipes and fittings. Some of the pipe coupling illustrations could have been larger and more explanatory.

Except for three or four chapters the book on the whole suffers from an attempt to cover too much ground and reads like a handbook. The book is sure to be of great use as a reference work in design offices but in the opinion of the reviewer it fails to come up to the claim of a text-book on the design of hydraulic components.

S. RADHAKRISHNA.

**Solid State Physics, Vol. IV.** Editors: F. Seitz and D. Turnbull. (Academic Press Inc., New York), 1957. Pp. xiii+540. Price \$ 12.00.

This is the fourth volume of the series and it contains five review articles.

The first article by W. Känzig is a systematic review of the state of our present knowledge of Ferroelectrics and Antiferroelectrics. Starting from definitions and a phenomenological classification, the dielectric susceptibility, the dielectric non-linearity and saturation, the electro-mechanical behaviour, spontaneous polarisation and strain, and the optical properties of the different ferroelectric and antiferroelectric crystals have been individually given. The thermo-dynamic theory is presented in a very clear manner. The structural studies of these substances by X-ray and neutron diffraction, Raman and Infrared spectroscopy have been presented. The article ends by describing the current theories on ferroelectricity. Dr. Känzig's article is of great utility as it highlights some of the gaps that exist in the literature today. For even the very awareness of this would induce many young workers of different disciplines to make contributions to this fruitful field.

The second article is by F. J. Blatt on the theory of the mobility of electrons in solids and it attempts to cover most of the topics that come under the heading of transport or conduction phenomena in solids. The one electron approximation is consistently used in this article and it is further assumed that when moving in a perfect crystal an electron behaves as though it is moving in vacuum, the crystalline structure of matter making itself felt as an alteration of the "effective" mass of the electron. It is probably worthwhile noting that while this simplified model has succeeded in explaining, a surprising variety of phenomena, there are a number of observations that have completely eluded explanation. After discussing the statistics of free electrons in metals and semiconductors, the Boltzmann transport equations have been formulated and the solutions for various phenomena like electrical conductivity, thermal conductivity, thermoelectricity, Hall effect, etc., have been derived making the simplified assumption that the energy surface in the wave vector space is spherical. The derivations have been generalised to the case when both the energy surface and the relaxation time are anisotropic. Next the different scattering phenomena arising from thermal vibrations, imperfections, disloca-

tions, faults, etc., have been discussed. Finally the effects arising due to the lack of thermal equilibrium in photon or electron distribution have been treated.

The third article is by T. O. Woodruff on the orthogonalised plane wave (OPW) method. The OPW method is based on the idea that the valence and higher wave functions in a crystal can well be represented as a sum of plane wave-like functions which while slightly modified near atomic sites remain essentially plane over the region of definition of a crystal. The practical methods of obtaining "interesting" solutions for the Schrödinger equation for a periodic potential using the well-known variational techniques starting with a trial function is described. Some of the applications where this technique has been used have been listed. One cannot but be astounded at the magnitude of the calculational effort required to carry out investigations of this type.

The fourth article is by R. S. Knox and it gives an exhaustive bibliography of atomic wave functions.

The last article is on the techniques of zone melting and crystal growing by W. G. Pfann of Bell Telephone Laboratories. It is perhaps the most comprehensive article that has appeared on this subject and would be truly appreciated by all the experimenters who are struggling on this rather difficult field. The technique of preparing crystalline substances for research using zone melting and zone refining techniques forms the central theme of this article. Main emphasis has been given to the removal of impurity, the controlled addition of desired solute atoms and the growth of single crystals controlling the contents of dislocations. After reading this excellent article one cannot but eagerly look forward to Dr. Pfann's forthcoming book on "Zone Melting".

The volume comes up to the high tradition that has been set up by the previous volumes.

S. RAMASESHAN.

---

**Biological Replication of Macromolecules.** (S.E.B. Symposium 12.) Edited by Sanders. (Cambridge University Press), 1958. Pp. vi + 255. Price 50 sh.

Genetics is a science with its own technique and its own terminology. The unit structure is the gene, a molecule or part of a larger molecule which is needed for a particular biochemical process, and which, unlike an enzyme, is copied when a cell divides, and is copied even when it has been changed. If this copying

process can be explained chemically genetics will be reduced to chemistry as chemistry is being reduced to physics. The book before us shows how close we are to such an explanation. The keywork is mostly being done on bacteria and viruses, but some is being done on cells of higher organisms.

Perhaps the biggest items of news, particularly for those who do not read French, are Jacob and Wollmann's account of their discovery that most of the genetic material of *Bacillus coli* is arranged in a ring, which can be broken at a number of places, and then penetrate a receptor or "female" bacillus, and Frédéricq's account of the colicinogenic factors in the same species. The latter are self-replicating or "hereditary" particles apparently independent of the other genes. Sanders, Huppert, and Hoskins give the first exact data on the rate of reproduction of an animal virus.

However, most papers are concerned with protein synthesis, and with the purification of deoxyribonucleic acid molecules which carry the information leading to the synthesis of one protein rather than another. Brown and Brown announce the isolation by chemical methods of such a molecule, but not, of course, its chemical characterization.

Seeing that the book is indispensable for those who wish to study the growing points, both of genetics and biochemistry, it is a pity that the binding is so bad that a page is already loose in the review copy sent to me.

. . . J. B. S. HALDANE.

**Technique of Organic Chemistry—Laboratory Engineering, Vol. III, Part II.** Edited by Arnold Weissberger. (Interscience Publishers), 1957. Pp. ix + 391. Price \$8.00.

The comprehensive issue of the *Technique of Organic Chemistry* is undergoing at present a thorough re-editing. Nine volumes in all are anticipated. The publication has now progressed to Vol. III, which in itself is subdivided into two separate parts of which Part I has already been published earlier. Part II has now become available and is under review. This part deals with a number of operational procedures and is headed by a chapter on "Selection of Materials for the Construction of Equipment", written by R. F. Eisenberg and R. R. Kraybill. It is followed by a chapter which deals with "Heating and Cooling" by R. S. Egly. Then follows a chapter on "Grinding, Screening and Classifying" by J. W. Axelson and W. C. Streib, "Mixing" by J. H. Rus-

ton, with a sub-chapter on "Special Equipment", by M. P. Hofmann, and finally closes with a chapter on "Operation with Gases" by G. H. Miller. Like all the earlier volumes, the contents of this present issue have been widened, reclassified and include most of the modern operational methods which meanwhile have entered in the organic chemistry laboratory techniques, in the same thorough way as has been attributed to the earlier volumes.

It is encouraging to read that aspects of thermodynamics, flow problems, heat transfer considerations have been introduced into the representations of cooling and heating in organic laboratory practice which have been carried out earlier and still to a certain degree now, from a merely empirical approach. Also applications of more modern equipment, like use of thermostats, resistance thermometers, etc., in the day-to-day practice are emphasised and described. The necessity of operational control systems for flow regulations is obviously taken as a common principle. Heat transfer coefficients are applied in the considerations and heat transfer nomenclature is used throughout. At the beginning of each chapter, one finds careful representation of theoretical developments and their practical applications as for instance, grinding, screening and classifying. It may be specially mentioned that a number of screening formulæ are proposed and their applications explained. In the classification part, the flow of solids through fluids theory is developed, resulting mainly in the friction factor formula, the application of which is further followed through. The same tendency of theoretical applications is followed in the chapter of mixing. In the chapter of operation with gases, one finds descriptions of working techniques, including the basic types of instrumentation and detailed drawings of manometers, valves, flow-meters, etc., which will give an organic chemist all the needed information about the most used equipment and their operational details.

The value of this issue is further enhanced by clear and systematic drawings, photographs of equipment, and such graphs from which the endeavour of indicating the principal factors involved becomes evident. It is further provided with an index including cumulative indices subdivided according to authors and subjects for all the nine volumes.

This new Volume III—Part II, Laboratory Engineering, will no doubt be a very helpful source of information for any organic chemist who wants to get advice in laboratory

techniques in general and in more modern techniques in special for day-to-day laboratory work, and can, therefore, be highly recommended.

E. WEINGAERTNER.

**Puzzle-Math.** By Dr. George Gamow and Dr. Marvin Stern. (Macmillan & Co., Ltd., London), 1958. Pp. 119. Price 8 sh. 6 d.

There can be real fun and entertainment in mathematics as the two authors have shown in this little book of brain twisters and apparent paradoxes. One of them (G. G.) is astrophysicist, author of 1, 2, 3, . . . infinity, a past-master in the art of interpreting science to the general public, and the other of them (M. S.) is a consultant to Convair, one of America's largest air lines, and together they lift the reader to amusing heights. Instead of posing the puzzles and problems in the abstract, the authors have given us interesting stories, where situations are created in which the problems have to be solved by mathematical thinking.

Here is a perplexing matter which the wise Sultan had to encounter. The Grand Vizier insisted that the Sultan should pass laws immediately to control the ratio of men to women in the land's future population, as it was becoming increasingly difficult for men of distinction, but of modest means, to maintain harems approximate to their status. The Sultan stroked his beard and pondered over the matter deeply, and said that he would issue a Proclamation, instructing all women of the land that they would be permitted to continue to bear children only if their children were girls. As soon as any woman gave birth to her first son, she would thereafter be forbidden to bear any more children, on pain of banishment. The Grand Vizier and the men of distinction were extremely pleased. As years went by, however, the shortage in the harems continued to be as acute as before. Why?

The illustrations by one of them (G. G.) add to the enjoyment of the stories.

A stimulating and enjoyable book.

S. R. K.

**Agriculture and Animal Husbandry in India.**  
By Dr. M. S. Randhawa, Vice-President.  
(Indian Council of Agricultural Research),  
August 1958. Price Rs. 15.

The book with a very attractive get up of about 250 pages of printed matter with another 100 pages of excellent illustrations is divided

into three sections: (i) Land, (ii) Crops and (iii) Farm Animals, Poultry and Fish.

Section I dealing with land has nine chapters and to help in a proper understanding of the varying soils of India, the earlier chapters of the section deal with geology, chief systems of rock formation and the derivation of the soils. The chapter on soils outlines the different soil groups that occur in the country and their characteristics. Some information is also provided on the fertility status of the soil groups. The chapters on 'Climate' and 'Vegetation' are a little more elaborate than others and contain all the information which every student of agriculture ought to know. There is a useful chapter on agricultural holding and its variation in different States. The information on size of holdings could have been more usefully treated in its relation to agricultural and animal husbandry regions which are however treated separately although there is a clear relation between the two. The chapter on irrigation deals with its history and development and provides full information on the various major and minor irrigation projects in progress in different States. Information on results of irrigation research is very brief and limited to schemes financed by the I.C.A.R. The information on water requirements of crops could have been supplemented with results available in Madras and Andhra Pradesh.

Section II which forms a little more than 50 per cent. of the contents of the book has 35 chapters and deals with crops classified into food crops, oilseed crops, fibre crops, other commercial crops, spices and plantation crops. Under plantation crops there is a chapter on fruit crops dealing with regions, their climate and fruits grown. Under each crop, information is provided on its distribution, cultivation practices, varieties grown and the improved strains that have become available as a result of breeding research that has been in progress in the country. No information is, however, available on the spread of the improved strains except in a few cases. The information on crops in general is necessarily very brief and more information can be gathered by referring to special publications included in the reference. That the information on some crops is more critical than on others is not the fault of the author nor a reflection on their relative importance to the country. The statement on page 105, that too wide a spacing in transplanted rice affects yields adversely is correct. But the lower yield is mainly the result of smaller number of ears per unit area, but there is

usually no fall in the number of grains per ear as has been stated. That the book does provide basic information on every crop including the less known spice crops such as cardamom and cinnamon, and plantation crops such as cinchona and lac is a commendable feature.

Section III which is the smallest in the book deals in 50 pages the classification and breeding characteristics of the farm animals and poultry. The five chapters of the section deal respectively with cattle, sheep, goats, poultry and fish. The information in this section may not fully justify the title of the book "Agriculture and Animal Husbandry in India", but nevertheless gives a good idea of the cattle wealth of India to a layman not fully acquainted with the problem. Information on breeding policy and work in progress is critical and highly useful.

The book, according to the author, has for its objective the bringing together of basic information about the important crops of India, their production, improved varieties as well as breeds of farm animals from the material already available in the Farm Bulletins, special issues of *Indian Farming* and the reports of the Indian Council of Agricultural Research and Ministry of Food and Agriculture. There is no doubt that the book has gone beyond this rather limited objective, and the author must be congratulated on providing a useful reference book that can interest administrators, agricultural officers, teachers and students. Students in the agricultural colleges can usefully supplement the information provided in the book by reference to special publications. The public who are now familiar with other publications of Dr. Randhawa know what to expect, and the present volume fully justifies their expectation. It may be mentioned in this connection that since Dr. Randhawa became the Vice-President of the I.C.A.R. the publication section has gained a great fillip, and the standard of publications has considerably improved.

A most commendable feature of the book is the inclusion of several excellent illustrations which surely add to the value of the publication. One remark that may be offered with regard to illustrations is that Plate 9 depicting a paddy crop does not represent a typical good crop of Indian rice. The illustrations and the high class get-up makes the publication too expensive (Rs. 15 per copy) to make it popular. But it is learnt that with the blocks for illustrations already available further cheaper editions are possible.

K. R.

### Books Received

*The Spectroscopy of Flames.* By A. G. Gaydon. (Chapman & Hall, London; India: Asia Publishing House, Bombay-1), 1957. Pp. x + 279. Price 50 sh.

*Synchronous Motors and Condensers.* By D. D. Stephen. (Chapman & Hall, London; India: Asia Publishing House, Bombay-1), 1958. Pp. x + 500. Price 60 sh.

*Landing Gear Design.* By H. G. Conway. (Chapman & Hall, London; India: Asia Publishing House, Bombay-1), 1958. Pp. viii + 342. Price 56 sh.

*The Wealth of India—Industrial Products.* Part IV, F-H. (Council of Scientific and Industrial Research, New Delhi-2), 1958. Pp. xvi + 304.

*Physical Techniques in Biological Research,* Vol. II. Edited by G. Oster and A. W. Pollister. (Academic Press, New York; India: Asia Publishing House, Bombay-1), 1958. Pp. xv + 502. Price \$ 12.80.

*Isotopic Tracers in Biology: An Introduction to Tracer Methodology.* By M. D. Kamen. (Academic Press, New York; India: Asia Publishing House, Bombay-1), 1958. Pp. xii + 474. Price \$ 9.50.

*Biological Ultrastructure.* By A. Engstrom and J. B. Finean. (Academic Press, New York; India: Asia Publishing House, Bombay-1.) Pp. ix + 326. Price \$ 8.00.

*Survey of Biological Progress,* Vol. III. Edited by Bentley Glass. (Academic Press, New York; India: Asia Publishing House, Bombay-1), 1957. Pp. 332. Price \$ 7.50.

*The Rede Lecture—The Problems of World Population.* By Sir Charles Darwin. (Cambridge University Press, London N.W. 1.) Pp. 40. Price 3 sh. 6 d.

*Elements of Chemistry.* By V. M. Parikh. (Continental Booksellers and Publishers, Tilak Road, Poona-2), 1958. Pp. 302. Price Rs. 5.

*Thermodynamics of One-Component Systems.* By W. N. Lacey and B. H. Sage. (Academic Press Inc., New York; India: Asia Publishing House, Bombay-1), 1957. Pp. xi + 376. Price \$ 8.00.

*Advances in Veterinary Science,* Vol. III. Edited by C. A. Brandly and E. L. Jungherr. (Academic Press, New York; India: Asia Publishing House, Bombay-1), 1957. Pp. xi + 579. Price \$ 13.00.

---

---

## SCIENCE NOTES AND NEWS

---

---

### Exceptional Sunflash Screened

An exceptional sunflash, several times the diameter of the Earth in size, was recently recorded by Soviet astronomers and filmed at the Crimean Observatory.

The Crimean Astrophysical Observatory of the USSR Academy of Sciences devotes great attention to the method of filming in studying swift processes on the Sun. For this purpose a special telescope is used—a coronagraph which permits the corona to be seen when the Sun is not in eclipse. The optical scheme of this telescope differs from the ordinary. A special metal disc covers the luminous surface of the Sun, thus creating an artificial eclipse, enabling the processes occurring beyond the rim of the chromosphere to be photographed. Such films help astronomers to make a more thorough study of solar phenomena, their dynamics and the laws governing them. Researchers have also gained the possibility, by means of fast-motion filming, to decelerate, as it were, the movements of the gigantic eruptions of incandescent solar matter. (USSR Information Department.)

### Expanded Polystyrene as Thermal Insulator

Expanded polystyrene is now being made in England. It is another of the sponge-like materials without the absorbent quality of sponge because all its air-cells are separate. Those cells also are smaller than most so that the material has more the appearance and consistency of rigid India rubber than of form rubber and yet it seems comparable in weight to balsa wood—to be precise one pound per cubic foot.

The multi-cellular structure makes it specially effective as a thermal insulator. It was found in use recently in Russia in the form of flasks, containing liquid hydrogen at an extremely low temperature. It has been applied widely in England in cold storage rooms, deep freeze rooms and road and rail containers. The building industry is taking up expanded polystyrene for sound as well as heat insulation and as anti-condensation membranes in walls and ceilings.

The principle underlying its manufacture gives the clue to its qualities. Small polystyrene beads incorporating an expanding agent are heated to swell to 60 times their original

size. They are then fused together into boards or blocks, white in colour and of good mechanical strength, which can be worked with the normal carpenter's tools.

A type of this material is now being manufactured in India and is expected to find a wide market.

### Telephony via the Moon

It has been known for several years that voice communication using the moon as a reflector was possible when long wavelength signals were utilized. Recent researches at the University of Michigan indicate that very short-wave radio or radar signals, which can be used in voice transmission, bounce off the moon without appreciable loss in quality. This means that the curvature of the earth no longer need be a factor in limiting communication distance—a radar signal has to travel in a straight line—so long as both transmitting and receiving equipment can "see" the moon.

It was thought that, because of the jagged mountains and craters which are known to exist in the moon, the moon would appear rough to a radar original. But a short wave signal requires only a few square feet area to be reflected. The moon has such areas that are smooth and hence the radar signals are reflected without a loss in quality.

The Michigan University investigations show that very short wavelengths of about an inch give such improvement in clarity that it is commercially feasible now to set up a worldwide network of stations by using the moon as a reflector. (*Jour. Frank. Inst.*, August 1958.)

### "Pioneer" used as a Repeater Station

According to the U.S. Air Force disclosure, scientists at Manchester "talked" to colleagues in Florida and Hawaii through space using the American "Pioneer" moon rocket as a radio repeater station. Scientists had long discussed the idea of using a satellite or space station as a connecting link between two distant points on earth, but this was the first practical proof that such a system was feasible. The moon probe tracking stations at Jodrell Bank, Cape Canaveral and Hawaii communicated with each other in the international code signals on the 108 megacycle band,

### New Device for Safety in Coal Mines

The sudden eruption of gases in a coal mine is a dangerous thing. On the initiative of Academician A. Skochinsky a seismo-acoustic station was set up at the Yuny Kommunar Pit in the Donets Basin.

A special instrument called a geophone is inserted into a 3-4-metre-deep hole drilled at the face. It catches extremely weak sound vibrations originating in the coal seams as a result of mechanical changes in the rock. The sounds are amplified by an electronic explosion-safe amplifier and, with the aid of a miniature radio station, are relayed to the surface laboratory where they are tape-recorded.

When the tape is studied, a complete idea of noises in the seam is gained. If the hourly rate of sound impulses increases, the operator reports the possibility of an eruption seven to twenty hours in advance and the workers leave the dangerous zone.

### 5 Million Atmospheres Pressure Attained

Soviet scientists, of the Laboratory of Physics of Super-High Pressures, claim having attained a record pressure of 5 million atmospheres. The method consists in imparting tremendous speed (over 8 kilometres per sec.) to a plate of some material and bringing it into collision with another plate which resulted in the explosion of both. Techniques have been evolved to measure within infinitesimal fractions of a second the pressure developed in the impact and to investigate the state of matter.

The new high pressure record will make it possible to gain a better insight into the laws governing the phenomena occurring in the depths of the earth and the structure of the earth's core. Super-high pressures cause highly peculiar chemical transformations and create new synthetic substances. Possibly diamond could be produced out of graphite by the explosion technique. Important results might also be obtained for students of molecular structure of matter and crystallographers.

These methods greatly widen experimental possibilities in high pressure physics. They have already carried out measurements of the dynamic compressibility of certain metals within the range of pressures from 400 thousand to a 4 million atmospheres. The greatest increase of density—2.26 and 2.28 times—has been registered with lead and bismuth respectively, that is, with elements possessing great atomic volumes. It has been established that the reorganization of crystalline structure occurring at

enormous pressures is unbelievably rapid. Now physicists are investigating the transparency and electrical conductivity of instantaneously compressed materials. It has been proved experimentally that at great pressures, insulators become conductors.

### Food and Oxygen from Algae

Photosynthesis, which replenishes life-sustaining oxygen in an endless cycle on earth, may enable man to travel in outer space and under the oceans for unlimited periods of time.

From a species of algae discovered by Constantine Sorokin at the University of Texas, a new strain of algae has been developed which increases 1,000 times a day as compared to only 8 times a day of the earlier types.

Very dense plant cultures of this fast-acting algae are irradiated with extremely intense light—many times the intensity of the brightest sunlight—from a new type of lamp recently developed by the G.E.C.

Carbon dioxide respired by men is removed from the closed atmosphere of sealed containers by the algae, which in turn produce oxygen in the same manner that green plants do on earth. In addition, the algae also produce large quantities of highly nutritious food material (e.g., proteins and vitamins).

Cultures of the new algal strain, nearly as thick as blood, were pumped very rapidly past the light, which is scarcely bigger than a pencil. This provided rapid stirring to utilize the well-established advantage of intermittent illumination. The alternate periods of high intensity light flashes were followed by dark rest periods for recovery. The algae growing in this closed circle system removed carbon dioxide and produced large quantities of oxygen and food. (From Report of T. A. Gaucher of General Dynamics Corporation, N.Y.)

### Belgian Scientist Terms X-Ray Dangers Greater than Fall-out

A warning of the atomic radiation danger in the over-use of X-ray examination was given recently by Prof. Zenon M. Bacq, of Liège University, at the Fourth General Assembly of the Council for International Organizations of Medical Sciences meeting at UNESCO House in Paris.

Prof. Bacq, former Chairman of the United Nations Scientific Committee on the Effects of Atomic Radiation, described this danger with facts and figures.



"The genetically significant dose of radiation from natural sources is 3 rem for a period of 30 years," he said. "The dose distributed to gonads by atomic fall-out during the same period will be about .01 rem—that is, 300 times less than the natural dose, if atomic tests are terminated at the end of this year.

"The dose distributed by physicians in countries where medical facilities are highly developed is from .5 to 5 rem—that is, from 50 to 500 times more than atomic fall-out or, in other words, a genetically significant dose as great as natural radiation."

Pointing out the need to draw the attention of physicians in general to the necessity of diminishing the quantities of radiation administered during X-ray diagnosis, Prof. Baq went on:

"Specialists believe that, if all those who conduct X-ray examinations were well-trained and equipped with appropriate apparatus, and that if physicians did not ask their colleagues, the X-ray specialists, to conduct useless or relatively useless examinations, it would be possible to lower the dose distributed to the population by at least a quarter of its present state—and to do so without doing the slightest harm to the precious contribution of X-ray examinations to the diagnosis of illness."—UNESCO.

### Streptomycin Dermatitis

Sensitivity to streptomycin is very common. Since the first account by Heilman *et al.* (1954) a variety of dermatoses have been reported in patients treated with this antibiotic. The list includes pruritus, erythema, eczema, photosensitivity, urticaria, exfoliative dermatitis, and purpura. Occasionally, the mucous membranes are affected, and cheilitis, stomatitis, and ulceration of the tongue have been described. Strauss and Warring (1947) reported an outbreak of dermatitis in nurses handling streptomycin, 4 out of 12 developing a rash on the hands and eyelids. Further reports (Rauchwerger *et al.*, 1948; Stringfellow, 1948; Wood, 1956) confirmed the fact that nurses giving streptomycin injections were liable to develop sensitivity to the drug. (*Brit. Med. J.*, No. 5048, June 14, 1958, p. 1378.)

### International Oceanographic Congress

The American Association for the advancement of Science in co-operation with UNESCO and the *Special Committee on Oceanic Research* of ICSU is planning and organizing an International Oceanographic Congress to be held during a two-week period from 30th August to

12th September 1959, at the United Nations Building, New York.

The purpose of the Congress is to provide a common meeting ground for all sciences concerned with the oceans and the organisms contained in them. The Congress will be devoted to the fundamentals of the marine sciences rather than to their applications.

It has been agreed by the Organizing Committee that the Congress will be centered around five symposia on the oceans: (1) The history, (2) The boundaries, (3) The deep sea, (4) Dynamics of organic and inorganic substances, (5) The marine life regime.

This notice should be considered as preliminary. Until further notices are issued, titles and abstracts of papers, which are publicly solicited by this notice, and any other correspondence should be sent to: Dr. Mary Sears, Chairman, Woods Hole Oceanographic Institution, Woods Hole, Massachusetts, U.S.A.

### Symposium on "Nuclear Fuel Cycles"

The Institute of Physics, one of the constituent bodies of the British Nuclear Energy Conference, is arranging a Symposium in London on "Nuclear Fuel Cycles" on 22nd and 23rd January 1959.

The programme is as follows: Session I. (a) Long-term reactivity changes, (b) Theory of once-through fuel cycles, (c) Perturbations due to fuel cycles;

Session 2. Optimization of fuel cycles for nuclear power stations;

Session 3. Fuel cycle operational problems. Application forms for tickets to attend the Symposium are obtainable from the Secretary of the Institute of Physics, 47 Belgrave Square, London S.W. 1, and should be returned as soon as possible.

### Symposium on "Iron and Steel Industry in India"

The Symposium will be held at the National Metallurgical Laboratory, Jamshedpur, from 4th to 7th February 1959 and will provide an international forum for establishing personal contacts and facilitating exchange of ideas on the development of iron and steel industry in general and that of India in particular.

The scope of the Symposium will cover broadly the following: (1) Raw materials, their assessment and preparation, (2) Physical chemistry of iron and steel production; (3) Recent technological advances in iron and steel production metallurgy in various parts of the world, (4) Casting and metal-working techniques,

(5) Alloy, tool and special steels production technology, (6) Present status and future expansion of iron and steel industry in India, (7) Utilisation of by-products of iron and steel industry.

Further particulars can be had from the organisers, National Metallurgical Laboratory, Jamshedpur-7.

#### Symposium on "The Nature of Coal"

It is proposed to hold a Symposium on the above subject at the Central Fuel Research Institute, India, from Monday, the 9th to Wednesday, the 11th February 1959. The Symposium is to be held under the joint auspices of the Central Fuel Research Institute, the Institute of Fuel (India Branch) and the Institute of Chemists, India. The Organizing Committee have arranged for six sessions as listed below :  
Session 1 : Origin and Systematics of Coal ;  
Session 2 . Petrographic and X-ray Studies of Coal ;  
Session 3 : Ultra-Fine Structure of Coal ;  
Session 4 : Coal Constitution : Physical Methods ;  
Session 5 : Coal Constitution : Chemical Methods ;  
Section 6 : Physico-Chemical Properties of Coal.

Further particulars can be had from the Director, Central Fuel Research Institute, P.O. Fuel Research Institute, Dhanbad Dist., Bihar, India.

#### Public Health Administration in U.S.S.R.— Study Tour Organized By WHO

Twenty-three senior public health administrators from various countries of the world will participate on a six-week study tour of U.S.S.R., sponsored by WHO. The group will be led by Dr. J. Peterson, Director of the Division of Organisation of Public Health Services at WHO Headquarters in Geneva. The Indian member of the group is Dr. N. Jungalwalla, Director, All-India Institute of Hygiene and Public Health, Calcutta.

#### Index to Plant Chromosome Numbers

The second issue of the *Index*, compiled from nearly 300 journals published in 1957, is now ready for distribution. There are around 2,000 listings of original chromosome counts from the entire plant kingdom and a bibliography of 196 papers from which the listings were taken. The price of each issue is \$ 1. Orders for subscriptions may be sent to : Dr. C. Ritchie Bell, Department of Botany, University of North Carolina, Chapel Hill, North Carolina, U.S.A.

#### Present Trends on Zoological Research in India

Under the auspices of the Zoological Society of India, it is proposed to hold a Symposium on the above subject at Delhi on the 19th and 20th January 1959. Intending participants should send abstracts with the full text of their papers to the Hon. Secretary-General, Zoological Society of India, Department of Zoology, Andhra University, Waltair, by 20th December 1958.

#### Change of Dates of "Symposium on Fungus Diseases in India"

The above Symposium previously notified to be held in December 1958 (*Curr. Sci.*, 1958, 27, 327), has been deferred due to unavoidable reasons. The final dates for the Symposium are February 5 and 6, 1959. Last dates for sending abstracts (not exceeding 300 words) and full papers have been extended to October 30 and December 15, 1958, respectively. Dr. C. G. Pandit, Director, Indian Council of Medical Research, New Delhi, has kindly consented to preside over the Symposium. Scientists from the U.S.A. and U.K. are expected to participate in the Symposium.

#### Award of Research Degree

Andhra University has awarded the D.Sc. Degree in Physics to Mr. D. V. G. L. Narasimha Rao for his thesis "On Certain Theoretical and Experimental Studies in Dielectrics at Microwave and Radio Frequencies" and the Degree of D.Sc. in Technology to Mr. P. Dakshinamurty for his thesis "Vapour Liquid Equilibria of Binary and Ternary Systems".

Dr. Buddhadev Sen (Calcutta) and Dr. Bharat R. Sant (Banaras) are working as Visiting Assistant Professors in the Chemistry Department of the Louisiana State University, Baton Rouge, U.S.A., on "Methods of Detection and Determination of Air-Pollutants", using for their study the most modern technique of Gas Chromatography.

Dr. Anil K. Mukherji (Allahabad), also working as Visiting Assistant Professor at the Louisiana State University is engaged in Microchemical Spot Test Analysis using the Weisz Ring Oven and the solvent extraction techniques.

Dr. B. Suseela (Hyderabad), recipient of Special Skinner Fellowship, is doing research at Mount Holyoke College, Massachusetts, working on Problems Relating to Molecular Structure of Organic Compounds and Their Complexes with Inorganic Metal Ions.

**Balances for . . . . .**

**SCHOOLS, COLLEGES, INDUSTRIAL LABORATORIES,  
RESEARCH INSTITUTES**

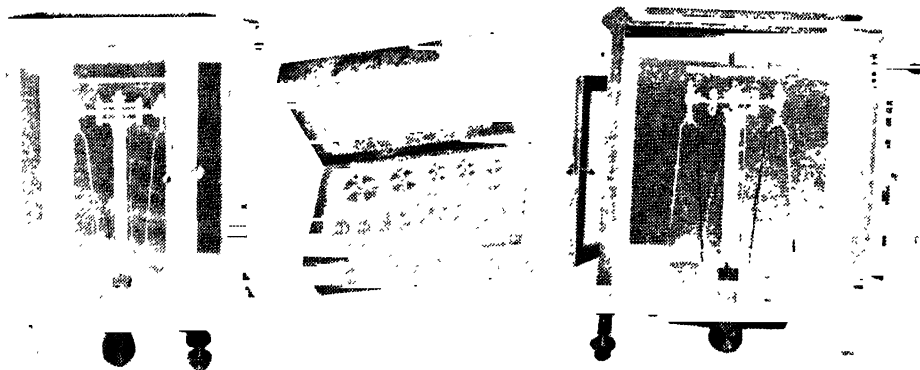

Catalogues sent on request

*Manufactured by :*

**SCIENTIFIC INDUSTRIES (India)**

**34, Banerji Bagan Lane, SALKIA (Howrah)**

**JOURNAL OF SCIENTIFIC & INDUSTRIAL RESEARCH**

**REVISION OF ADVERTISEMENT AND SUBSCRIPTION RATES**

*with effect from January 1958*

**REVISED ADVERTISEMENT RATES\***

INSERTION	FULL PAGE	HALF PAGE	QUARTER PAGE
Twelve	Rs. 700·00	Rs. 400·00	Rs. 250·00
Six	Rs. 400·00	Rs. 250·00	Rs. 150·00
Single	Rs. 80·00	Rs. 50·00	Rs. 30·00
2nd and 3rd cover pages and pages facing reading matter			Rs. 800·00 each.
Fourth cover page			Rs. 1,000·00

\* The revision will not affect existing contracts and will take effect after the expiry of the contracted period.

**REVISED SUBSCRIPTION RATES**

ANNUAL SUBSCRIPTION: Inland Rs. 20·00; Foreign £ 2 or \$ 6·00  
PRICE PER ISSUE: Inland Rs. 2·00; Foreign Sh. 4 or \$ 0·60

*For particulars write to:*

**UNDER-SECRETARY, PUBLICATIONS DIRECTORATE**

**COUNCIL OF SCIENTIFIC & INDUSTRIAL RESEARCH**

**OLD MILL ROAD**

**NEW DELHI 2**

## THEORETICAL PHYSICS IN THE UNITED STATES OF AMERICA\*

**P**ERHAPS the most important feature of scientific effort in the twentieth century is the simultaneous advance in fundamental sciences on the one hand and in technology on the other. This is particularly noticeable in the United States where despite the fact that technology has had such an impact on the amazing prosperity of the United States and scientific man-power is in constant demand by industry, fundamental research still engages the attention of the most gifted minds which emerge from its universities. As a typical example of this trend towards basic sciences, we shall consider the status of and contributions in theoretical physics in America today.

Physics deals with the study of matter and natural phenomena and such study consists of two parts:

- (1) The precise measurement of physical quantities,
- (2) Interpretation of such measurements and consequent understanding of natural phenomena.

The first part falls within the domain of the experimenter, the second, of the theoretical physicist. Till the advent of quantum mechanics, the connection between experiment and theory was quite direct, since the description of nature was based on classical concepts. But for a quantum mechanical description of matter, a complex mathematical formalism was introduced; no longer a 'pictorial' and 'conventional' method possible. Hence the relationship between experimental observation and the theories became more indirect and involved, perhaps even obscure except to those familiar with mathematical theories. On the other hand, the testing of these theories demand such precision in measurement that the experimenter had to devise new and ingenious techniques based on inventive technology and engineering.

The Universities in America realised this distinction quite clearly and soon became centres of fundamental research besides being

just 'training grounds' for technical personnel in industry. With the vigour and initiative characteristic of America's growth and expansion, they invited talent from all parts of the world. The unhappy state of Europe during the turbulent period of the World War became a fortuitous circumstance for America's intellectual and scientific advancement—Einstein, Bohr and scores of leaders of scientific thought moved into the new world which was ready to imbibe the spirit and influence of basic research and fundamental science.

By the end of the Second World War, not merely the importance of mathematical sciences as 'tools' for technology, but their significance as an independent discipline necessary for the intellectual vitality and prestige of a nation was well realised. Theoretical physics became 'fashionable' and pure mathematics attained its 'queenly' pre-eminence. The 'competition' between the theorist and experimenter in suggesting 'leads' to the understanding of nature, led to very important theoretical discoveries and advances in experimental techniques. Laboratories supported by governmental aid and the co-operative effort of the Universities poured forth data on fundamental physical phenomena as 'food for theoretical speculation'. Thus the theoretical study and interpretation of such phenomena became an active pursuit and profession and ceased to be just the close preserve of the leisured savant and the profound natural philosopher.

In studying the progress of theoretical physics, it is convenient to classify it into three broad divisions:

- (1) Formal and deductive approach to quantum mechanics,
- (2) Interpretation of high energy phenomena and elementary particle interactions,
- (3) Low energy phenomena and study of nuclear "structure".

### 1. DEDUCTIVE APPROACH

The logical approach to quantum mechanics was initiated by Dirac with his formulation of the theory of the electron. While Heisenberg, Schrodinger and other architects of modern physics built up quantum theory by intuition and physical insight, Dirac was one of the first to make a formal deductive and rigorous formulation.

Encouraged by the successful prediction by Dirac of the positron and anti-particles

---

\* This article is based on the impressions of the author during the period of his residence (1957-58) as visiting member at the Institute for Advanced Study Princeton, U.S.A. He has great pleasure in thanking, Professor J. R. Oppenheimer the Director of the Institute, for his warm hospitality and acknowledging the travel grant of the Asia Foundation which enabled him to accept the membership.

in general, in the early forties theoreticians like Fierz, Pauli and Bhabha seriously attempted to "deduce" equations on a postulational basis. Though these attempts did not meet the desired success, they helped to inject more logic and rigour into theoretical physics. In the United States, Schwinger is the most famous exponent of the view originally expressed by Einstein that the axiomatic basis of theoretical physics cannot be extracted from experience but must be freely invented.

The deductive and logical approach naturally attracted the attention of pure mathematicians like Neumann and Weyl at the Institute for Advanced Study. The classic works of Neumann on the logical foundations of quantum mechanics and of Weyl on group theoretic methods are considered as part of the necessary equipment of any theoretical physicist today. But somehow, pure mathematicians did not make any substantial contribution to the content of quantum mechanics, presumably, as has been stressed in an interesting review of Hilbert's life, because of the fundamental difference between a mathematician's insight and a physicist's intuition. However, the abstract approach still holds the minds of many theoretical physicists and systematic attempts are being made to formulate field theory in a rigorous and deductive manner. The work of Nishijima and Wightman in the United States, the recent proofs of dispersion relations by Taylor, Oehme and others at the Institute for Advanced Study are examples of such attempts. Very recently, Heisenberg and Pauli have attempted to explain the mass spectrum of elementary particles by means of a non-linear spinor equation which has been quantised in a revolutionary way by making use of the indefinite metric originally due to Dirac. But it has to be conceded that despite the recognition of the necessity of a deductive approach to quantum mechanics, there is considerably widespread scepticism in the United States whether such approach will 'deliver the goods' in the near future. There seems to be more faith in the opinion of MaxBorn that the 'art of scientific prophecy can be learnt not so much by reliance on abstract reasoning as by deciphering the secret language of nature' from nature's documents, the facts of experience.

## 2. HIGH ENERGY PHYSICS

The first major American contribution after the Second World War was in the field of quantum electrodynamics. By 1948, the application of quantum theory to electrodynamics

initiated by Dirac two decades earlier reached a stage when theoreticians were faced with fundamental difficulties which needed essentially new methods and they were provided by the outstanding work of Schwinger at Harvard and Bethe, Feynman and Dyson at Cornell.

The quantum electrodynamics based on the classical concept of point charge gave rise to well-known difficulties such as the infinite self energy of the electron and the "ultra-violet catastrophe". Essentially connected with these difficulties are the infinite fluctuations of the charge and current in the case of matter field and the fluctuations in the field strength in the case of electromagnetic field even in the vacuum state. The existence of such fluctuations of charge and current in the vacuum implies that the vacuum acts like a polarisable medium which causes the phenomena of scattering of light by light or by electrostatic field.

Further progress in the subject came with the experimental discovery of the anomalous magnetic moment of electron by Kusch and the shift in the levels of the hydrogen atoms by Lamb and Rutherford, made possible by the war-time development of the electronic and microwave techniques. To understand these electrodynamic effects, it was found necessary to introduce the idea of renormalization of mass and charge. Suitable covariant renormalization techniques were developed by Schwinger, using formal field theoretical methods. Quite independently without any considerations of field theory, Feynman developed a most unconventional approach based on propagation kernels of single particles which was inherently covariant. His graphical representation of quantum mechanical processes, first applied to electrodynamics is now extensively used even in processes involving other elementary particles. The essential equivalence of Feynman's graphical approach and the formalism of Schwinger was established in a fundamental paper by Dyson. "The evolutionary process by which relativistic field theory was escaping from the confusion of its non-relativistic heritage has recently culminated in a new formulation of quantised theory of fields by Schwinger starting from a basic action principle". This also revealed that the connection between spin and statistics stems from invariance requirements.

By 1952, it was felt that quantum electrodynamics had reached a state of comparative completeness and it was not likely that future development will drastically change the results

of electron theory which gave quantum electrodynamics a certain enduring value. "The real significance of the work of the past decade lies in the recognition of the ultimate problems facing electrodynamics, the problems of conceptual consistence and of physical completeness. No final solution can be anticipated until physical science has met the heroic challenge to comprehend the structure of the submicroscopic world that nuclear exploration has revealed". With the development of high energy machines in the post-war era, many phenomena were observed involving the creation of new and strange particles and high energy physics naturally included the study of these new processes like the production of mesons in nucleon-nucleon collisions and recently in electron-nucleon collisions, and the production of strange particles in high energy interactions.

The vast mass of data from the high energy machines from centres like Brookhaven and Berkeley raised a maze of problems as a challenge to the most gifted of theoreticians. The most famous of them all was the  $\theta$ - $\tau$  puzzle—the identity of the masses and life-times of the two types of K-particles with different modes of decay and parity assignments. Dailitz's analysis of this puzzle claimed great attention at the Rochester Conference in 1956 and it is rather exciting to read the discussions after Yang's introductory talk in which Feynman, Yang, Lee, Bloch, Gellman and Marshak participated. It was of course given to Yang and Lee to question boldly the invariance of parity under space reflection in weak interactions and suggest the Cobalt experiment which was performed by Wu *et al.* and which brilliantly confirmed their predictions. Their remarkable paper reveals the new trend which characterises theoretical physics today,—the theoretical physicist having a live contact with experimental results and going so far as to suggest types of experiments to test the theories. More recently Yang and Lee have proved that analysis of the asymmetry in the angular distribution of the  $\pi$  decay will determine the spin of the  $\Lambda^0$  particles.

During the study of weak interactions, the interest in the universal Fermi interaction has been revived to explain all weak interactions such as  $\beta$ -decay,  $\mu$ -capture and hyperon decay. Feynman and Gellman have proposed one such theory by extending the two-component formalism to all Fermi particles while Marshak and Sudershan have employed the "chirality" invariance to the same end. For

all these theories the exact coupling between Fermi particles is of decisive importance. It looks at present that the vector and axial vector coupling will be preferred rather than the scalar and tensor. Pais and others are investigating the relative parities of the  $K^\pm$  and  $K^0$  mesons.

While of course the theory of weak interactions claimed great attention following Lee and Yang's discovery, attempts are also being made to understand the strong interaction of heavy particles. Gellmann has proposed a global symmetry, *i.e.*, a universal pion-coupling between all heavy particles. He envisages a degenerate spectrum for the eight baryons in the presence of the pion-coupling. When the K-particle coupling is switched on, the baryons are split into groups as observed, *i.e.*, charge independent multiplets. Of course, the study of strong and weak interactions are included together in the former deductive approach mentioned before.

Meanwhile, there was another important theoretical development in the field of interactions of elementary particles involving strong coupling. In view of the evident breakdown of the perturbation theoretical approach to the study of interactions involving strong coupling, there was a long-felt need for a radically different method to tackle such problems. Goldberger at Chicago first realised the importance of the study of the analytic properties of S-matrix from general considerations and by the use of complex variable theory and in particular Hilbert's theorem he was led to relations connecting the real part of scattering amplitude to the integral over the imaginary part, the latter being related to the total cross-section. After a number of non-rigorous but intuitive derivations of such relations by Goldberger, Gellman, Salam and others, the dispersion relations for meson scattering by nucleons have been established in a rigorous way by Bogoliubov from U.S.S.R. and Bremmermann and others from U.S.A. The same approach has been employed in the electromagnetic and weak interactions especially by Bogoliubov. Goldberger is currently investigating dispersion relations for  $\pi$ -meson decay. The "dispersion relation" approach has been utilised to study nucleon-nucleon scattering, the electromagnetic structure of nucleons and similar problems by Goldberger, Chew, Nambu and others.

While high energy physics became fashionable consequent on Lee and Yang's discovery, non-relativistic theories at low energies also

demanding considerable attention. Chew and Low's successes in the theory of pion-nucleon interactions exemplify such attempts. They have shown that if one assumes: (1) Pseudo-scalar interaction, (2) Charge independence, (3) Negligible nucleon recoil, and (4) Predominantly P-wave interaction, then the crossing-symmetry, and unitarity of S-matrix are sufficient to establish the remarkable features of nucleon-pion interaction, in particular the resonance. The same method has also been applied for explaining photo-production of pions by utilising the gauge invariance characteristic of electromagnetic interactions.

Drell and others have extended the Chew's theory to include S-wave interaction which is strongly isotopic spin dependent, the nature of which is not fully understood. Chew's theory has also been applied to nucleon-nucleon interaction potential. Assuming only P-wave coupling, Gartenhaus has calculated the nucleon potential upto fourth order in the coupling constant. But this potential is inherently defective in that it does not yield any spin-orbit coupling. Recently, Marshak and Signell have proposed a phenomenological potential which simply consists of Gartenhaus potential plus spin-orbit interactions term obtained from phenomenological considerations.

As has been recognised for a long time, the knowledge of nucleon-antinucleon interaction is very essential in explaining the problem of nuclear forces. Attempts have been made to explain the large annihilation cross-section for  $N\bar{N}$ . Chew's theory has also been applied to the problem of nuclear forces by Miyazawa from Japan, Klein and McCormick from U.S. and Novoshilov from U.S.S.R. who have reduced the problem of two nucleon interaction to that of one nucleon. In recent years, the Compton scattering of protons have been re-examined from the point of view of Chew's theory.

### 3. LOW ENERGY PHYSICS AND NUCLEAR STRUCTURE

While in the field of high energy physics we deal with the nature of elementary particles individually and their interactions, the collective properties of nuclear matter and the many-body problem of the nucleus (especially heavy nuclei) depends on data obtained from comparatively low energy phenomena. These theoretical considerations are usually referred to as "problems of nuclear structure"; the aim of which is to derive the nuclear energy levels, nucleon wave functions, imaginary and real

potentials associated with the nucleus. In this, theoreticians have been puzzled for a long time by an apparent contradiction, namely, whatever we know about the nuclear forces indicates that these forces are very strong and have a dependence on position, repulsive cores, exchange character and other "peculiar" considerations. On the other hand, the properties of the nuclei at low energies both for bound states and for the interactions of nucleons with nuclei show the remarkable validity of the one-body approximation based on a very smooth potential without large magnitudes and large variation. This is the basis of many models which work so well, e.g., shell model and the optical model. The apparent contradiction led some people like Teller and Johnson to go to an extreme point of view, viz., to give up any connection between the structure of the nucleus and the nuclear forces as observed in nucleon-nucleon interaction. On the other hand, Brueckner and collaborators attempted rather successfully to resolve this contradiction. The essential merit of the outstanding work of Brueckner lies in that "it takes the nuclear forces as they are delivered to us and constructs from this a theory of complex nuclei, which gives us as good an approximation as possible in the one-body picture". Further contributions of Goldstein, Tobocman, Watson, Reisenfeld may be mentioned in this connection. Professor Bethe is more inclined to the programme of Brueckner than the extreme point of view of Teller and Johnson. The experimental work relating to the optical model, the polarisation of neutrons at low energy and nuclear reactions involving light and heavy nuclei are being provided from various American laboratories. The emphasis of the theoreticians is still being felt in this field as in high energy physics. The contributions of Professor Lee on the theoretical implication of the parity violation in  $\beta$ -interaction followed by that of C. S. Wu on the experimental evidence of non-conservation of parity in  $\beta$ -decay at the Rehovoth Conference clearly indicate the very close connection between the fields of low energy and high energy physics. The discovery of parity non-conservation in weak interaction which originated in the  $\theta$ - $\tau$  puzzle of the high energy phenomena has become very important in  $\beta$ -interactions.

In a wider sense, the study from a fundamental point of view of problems in different fields of physics has clearly demonstrated the

inter-connection between them and the need for frequent exchange of views in conferences like those held annually at Rochester where both the experimenter and the theoretician are able to discuss the problems together. America has taken the lead in the organisation of such conferences, a lead soon followed in Europe, Japan and Russia. The proceedings of such conferences are considered sources as important as publications in scientific journals for future research.

It is the earnest hope of the young scientific community in India that at a time when our country is almost possessed by a desire for technological advancement, enough emphasis should be laid, as has been done in the United States on fundamental sciences as a necessary and independent discipline.

University of Madras, ALLADI RAMAKRISHNAN,  
Madras.

---

### LIFE OF SATELLITES

ONCE a satellite is put in orbit, how long it will exist is determined by the two factors: (i) the initial period of its revolution which depends only on the major axis of the orbit, and (ii) the resistance or impeding force to its motion. By watching the diminution of the period of revolution we can get a good idea of the change in dimensions of the orbit and the decline in its altitude over the earth's surface.

The satellite moves in an extremely tenuous atmosphere of density not exceeding one four-thousand millionth of the density of air at the earth's surface, and the force of resistance in the lowest part—the perigee—of the orbit is not more than 2 g. per square meter. Even this small impeding force affects the satellite's motion substantially. The maximum height of the orbit—the apogee—diminishes considerably faster than the minimum height—the perigee—and the orbit gradually becomes more and more circular. The impeding force also depends on the "lateral load" or the weight of the satellite per unit area of its surface.

The dependence of the satellite's life on the perigee height can be seen from the following figures which are calculated for orbits which are almost circular. For a perigee height of

1,000 km., the life is practically indefinite; for 500 km. it will live from 2 to 7 years depending on the magnitude of the lateral load; for 160 km., the satellite will make but one revolution only.

*The Three Sputniks.*—When placed in the orbit, Sputnik I and its carrier rocket had the same perigee heights and same periods of revolution. But because of the difference in the lateral loads, their periods diminished by 1.6 and 2.7 seconds respectively in 24 hr. This accounted for the life of the sputnik being 92 days while that of the carrier rocket was only 58 days. Sputnik II and its carrier rocket had almost the same lateral load as the carrier rocket of Sputnik I. But they revolved round the earth for 161 days. The longer life of Sputnik II was due to the fact that its initial period was 103.7 min. which was 7.5 min. more than that of the carrier rocket of Sputnik I.

Sputnik III had its initial perigee height practically the same as those of the two earlier sputniks. But its initial period was greater, being 106 min. Its lateral load also is greater. Preliminary calculations indicate that Sputnik III will have a life-time of nearly 500 days (1½ years) and its carrier rocket about 6 months. (Y. Morozov in *Soviet News*.)

---

### COBALT-60 USED IN EXPERIMENTS TO CONVERT COAL TO GAS

SCIENTISTS at Columbia University in New York are experimenting with a powerful radiation source to try to convert coal to methane, the major ingredient of natural gas. The source used in this research is a 20-lb. 1,400 curie block of radioactive cobalt-60, one of the biggest pieces of radioactive cobalt available to scientists in the United States.

With it chemists and chemical engineers are

studying the effects of radiation on the hydrogenation of coal to methane.

The coal is heated, exposed to high pressures and radiated with the cobalt-60 source. Radiation helps to break up the coal and catalyzes the so-called hydrogenation reaction in which the natural coal is broken down into a gaseous mixture consisting mostly of methane.—*Science Newsletter*, 4573.



## ELECTRICAL EFFECTS IN THE INFRARED AND THE NEAR ULTRAVIOLET ABSORPTION SPECTRA OF ORGANIC ISOTHIOCYANATES

C. N. RAMACHANDRA RAO,\* J. RAMACHANDRAN† &amp; S. SOMASEKHARA‡

Contribution from the Departments of Chemistry, De Paul University, Chicago, Illinois, U.S.A., and Purdue University, Lafayette, Indiana, U.S.A.

THE important purpose of correlating the frequency shifts and intensity changes in absorption spectra is to get a better understanding as to how different electronic interactions affect any particular absorption band. Consideration of the infrared absorption spectra together with the ultraviolet absorption spectra would, therefore, provide interesting information concerning both the ground and excited states. Since the quantum mechanical calculations of electron distribution around linkages are not sufficiently accurate, it is considered important to study the effect of structural changes on the band positions and intensities of a series of related molecules in the infrared and ultraviolet regions.

As a result of a number of investigations,<sup>1-4</sup> it has been possible to conclude that the wavelength changes in the B-band of the ultraviolet absorption spectra of benzene derivatives are mainly caused by resonance and steric interactions. Consequently, the position of the B-band in the ultraviolet absorption spectra for *para*-disubstituted benzenes appears to be a good measure of the resonance effects. It has also been possible to conclude that the infrared fre-

quency shifts in *meta*- and *para*-disubstituted benzene derivatives are determined by the same factors that decide the chemical reactivity.<sup>5</sup> In this paper we have reported on the electrical effects in the infrared and the near ultraviolet absorption spectra of organic isothiocyanates.

There have been no reports of the ultraviolet absorption spectra of organic isothiocyanates in the literature.<sup>6</sup> We have now studied the near ultraviolet absorption spectra of a number of alkyl and aryl isothiocyanates. Recently, Lieber, Rao and Ramachandran<sup>7</sup> have made extensive studies on the infrared spectra of organic isothiocyanates and have assigned the characteristic isothiocyanate vibration frequency between 2060 and 2105 cm.<sup>-1</sup> We have now studied the substituent effects on this vibration frequency in *para*-substituted phenyl isothiocyanates.

The ultraviolet absorption spectra were recorded in purified cyclohexane using a Cary recording spectrophotometer and also a Beckman model DU spectrophotometer. The wavelengths ( $\lambda_{max}$ ) in  $m\mu$  and the molar extinction coefficients ( $\epsilon_{max}$ ) corresponding to the absorp-

TABLE I  
Infrared and ultraviolet absorption spectra of organic isothiocyanates (R-NCS)

R	$\nu$ , cm. <sup>-1</sup>	$\lambda_{max}$	log $\epsilon_{max}$	$\lambda_{max}$	log $\epsilon_{max}$
CH <sub>3</sub>	.. ..	249	3.34	..	..
C <sub>2</sub> H <sub>5</sub>	.. ..	249	3.41	..	..
<i>n</i> -C <sub>4</sub> H <sub>9</sub>	.. ..	249	3.50	..	..
<i>n</i> -C <sub>7</sub> H <sub>15</sub>	.. ..	249	3.50	..	..
C <sub>6</sub> H <sub>5</sub>	.. 2045	270.5	4.11	281	4.12
4-CH <sub>3</sub> C <sub>6</sub> H <sub>4</sub>	.. 2050	272	4.20	283.5	4.19
4-ClC <sub>6</sub> H <sub>4</sub>	.. 2037	276	4.20	287.5	4.19
4-CH <sub>3</sub> OC <sub>6</sub> H <sub>4</sub>	.. 2062	275.5	4.19	286.5	4.16
4-N(CH <sub>3</sub> ) <sub>2</sub> C <sub>6</sub> H <sub>4</sub>	.. 2093	297.5	4.58	310	4.54
4-CH <sub>3</sub> COC <sub>6</sub> H <sub>4</sub> *	.. 2022	292	4.37	305	4.40
4-NO <sub>2</sub> C <sub>6</sub> H <sub>4</sub> †	.. 2016	312.5	4.24	323	4.15
2-ClC <sub>6</sub> H <sub>4</sub>	.. ..	276.5	4.09	286	4.08

\* This compound has an additional peak around 240  $m\mu$ . † This compound also has an additional peak around 250  $m\mu$  and the 323  $m\mu$  band appears as a shoulder.

\* Department of Chemistry and Radiation Laboratory, University of California Berkeley, California, U.S.A.

† Department of Biochemistry, University of California,

‡ Department of Chemistry, Northwestern University, Evanston, Illinois, U.S.A.

tion maxima are summarized in Table I. The infrared spectra were recorded in carbon tetrachloride solutions using a Perkin Elmer, Model 21, spectrophotometer. The -NCS vibration frequencies are listed in Table I.

All the *n*-alkyl derivatives show a band at 249  $m\mu$ , characteristic of the isothiocyanate group. The intensity of this band appears to increase with the chain-length of the alkyl group. The phenyl derivatives exhibit two absorption bands at wavelengths considerably higher than the alkyl derivatives. The intensities of these bands are also much greater than those of the alkyl derivatives.

The  $\lambda_{\max}$  values of the *para*-substituted phenyl isothiocyanates can be correlated with the Taft resonance parameters<sup>8</sup> and the Hammett  $\sigma$ -values<sup>9</sup> of the substituents and they approximately follow Rao's correlations.<sup>3,4</sup> The approximately linear relations seem to hold as long as the *para*-substituent is an electron donating group, indicating that the isothiocyanate group is electron-withdrawing in nature. The large wavelength shifts in the *p*-acetyl and the *p*-nitro derivatives are probably due to the absorption of these groups themselves. It is interesting to note that the *p*-acetyl derivative shows an absorption band around 240  $m\mu$ , corresponding to the B-band of acetophenone indicating that there is negligible interaction between the isothiocyanate and the acetyl groups. This is understandable since both the groups are electron-withdrawing in nature.<sup>3,4</sup> The *p*-nitro derivative similarly shows an absorption band around 250  $m\mu$  probably due to the absorption of the nitro group. The intensities of the ultraviolet bands of these phenyl derivatives seem to increase with the electron-contributing power of the *para*-substituent. This is consistent with the general trends proposed by Rao and Silverman.<sup>10</sup> The *ortho*-chloro derivative absorbs at about the same  $\lambda_{\max}$  as the *para*-chloro derivative; however, there is considerable decrease in the intensity of the bands. Such intensity changes indicate small steric influence of the *ortho*-substituent.<sup>11,12</sup>

The isothiocyanate vibration frequencies in the *para*-substituted phenyl derivatives show a nice trend with the reactivities of the groups. The plots of the frequency  $\nu$ , against Hammett  $\sigma$  or Brown  $\sigma^+$  values<sup>9,13</sup> are found to be excellently linear. However, the  $\nu$ - $\sigma^+$  plot (cf. Fig. 1) seems to show lesser deviations from linearity just as the many other systems investigated earlier by Rao and Silverman.<sup>5</sup> The slope of this plot is about -30. The  $\sigma^+$  value of the

acetyl group was assumed to be about the same as the  $\sigma$  value for the group since the group is *meta*-directing in nature.<sup>14</sup>

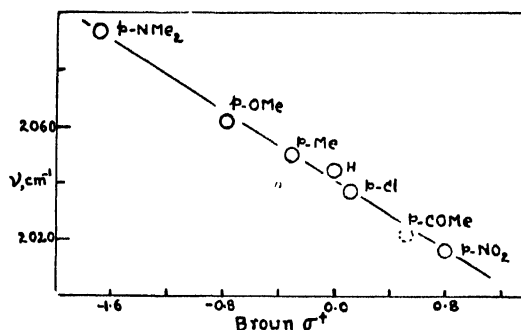

FIG. 1. Correlation of the isothiocyanate vibration frequencies in *para*-substituted phenyl isothiocyanates with the electrophilic substituent constants

The authors' thanks are due to Professor E. Lieber of De Paul University for his interest, and to Mrs. Marge Angell and Mr. W. Baitinger of Purdue University, for their assistance in taking the spectra.

1. Doub, L. and Vandenbelt, J. M., *J. Amer. Chem. Soc.*, 1947, **69**, 2714.
2. Forbes, W. F. and Ralph, A. S., *Canadian J. Chem.*, 1956, **34**, 1447.
3. Rao, C. N. R., *Chem. and Ind.*, 1956, 866; 1957, 1239.
4. —, *J. Sci. Industr. Res.*, 1958, **17**, 56.
5. — and Silverman, G. B., *Curr. Sci.*, 1957, **26**, 375.
6. Hershenson, H. M., *Ultraviolet and Visible Absorption Spectra*, Academic Press, New York, 1956.
7. Lieber, E., Rao, C. N. R. and Ramachandran, J., *Spectrochim. Acta* (in print).
8. Taft, R. W., in *Steric Effects in Organic Chemistry*, edited by M. S. Newman, John Wiley & Sons, Inc., New York, 1956, Chapter 13.
9. McDaniel D. H. and Brown, H. C., *Org. Chem.*, 1958, **23**, 420.
10. Rao, C. N. R., and Silverman, G. B., *J. Sci., Industr. Res.*, 1958, **17**, 131.
11. Braude, E. A. and Soncheimer, F., *J. Chem. Soc.*, 1955, 3754.
12. Forbes, W. F. and Mueller, W. A., *Canadian J. Chem.*, 1957, **35**, 488.
13. Brown, H. C. and Okamoto, Y., *J. Amer. Chem. Soc.*, 1958, **80**, 4979.
14. Rao, C. N. R. and Goldman, G. K., *Canadian J. Chem.*, 1958, **36**, 1596.

## GEOPHYSICAL EXPLORATION IN THE COASTAL SEDIMENTARY BELT OF MADRAS STATE\*

L. N. KAILASAM

Geological Survey of India

AS is well known, the structurally stable mass of Peninsular India is flanked on its eastern coast by sedimentary beds of Cretaceous and Tertiary ages laid down by marine transgressions. There are also sporadic occurrences of Upper Gondwana beds between the Archæans and the Cretaceous-Tertiary formations. A sketch map of this belt, based on the *Geological Map of India* published by the Geological Survey of India (Fig. 1) shows the distribution of the

occasionally intervening them. They are buried by alluvium in the northern side, while on the eastern side, they are overlain by Cuddalore sandstones of Miocene age. The Cretaceous rocks of this area, as is well known, consist of four stages, viz., (a) the Uttattur (lowest) stage comprising sandy clays, calcareous shales and fine silts and occasionally some arāneaceous limestones, (b) the Trichinopoly stage consisting of sandstones, grits and occasionally shales and shell-limestones, (c) the Ariyalur stage which appears more extensively developed and comprises grey to brown argillaceous sandstones, white sandstones and sandy limestones, and (d) the Niniyur stage consisting of grey to brown calcareous sands and shales with embedded fragments of flint and chert. The Uttattur beds are presumed to have an average thickness of 1,000 ft. and the Ariyalur beds also have the same order of thickness. As observed on the surface, these beds have a general easterly to north-easterly dip, the average dip of the Uttattur beds being of the order of 10° while that of the Ariyalur beds is of the order of 3 to 5°. All these four stages of the Cretaceous rocks are highly fossiliferous (*vide* Krishnan: *Geology of India and Burma*, 1956).

Exposures of the Cuddalore sandstones of Tertiary (Miocene) age, which lie unconformably over the Cretaceous rocks, extend from Madura in the south to Pondicherry in the north. In view of the fossil evidence observed in what look like Lower Eocene limestones and also in Upper Eocene rocks in the Pondicherry area, an Eocene sequence may also be expected to occur, intervening the Cretaceous and Cuddalore formations. According to recent reports, Eocene limestones have been encountered in deep boreholes sunk for groundwater on the eastern coast, south of Cuddalore town. The Cuddalore sandstones are generally ferruginous and include mottled grits, argillaceous and silicified sandstones and have a gentle seaward dip.

The Upper Gondwana rocks in this area consist of micaceous shales, grey sandstones, and grits. They rest on the Archæan gneisses and are overlain by the marine Cenomanian beds mentioned above. Exposures of the Upper Gondwanas are seen near Uttattur village in

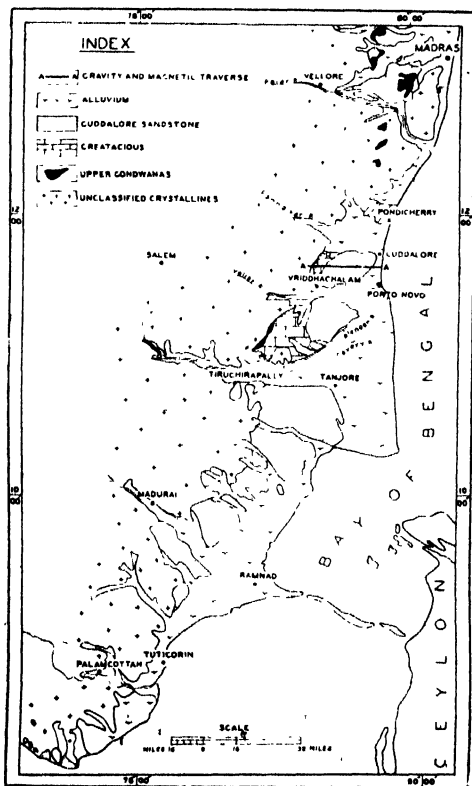

FIG. 1

exposures of these rock formations in the Madras coastal belt.

In the Trichinopoly District, the Cretaceous rocks are underlain by granitic gneisses, but thin beds of Upper Gondwanas also occur

\* Published with the kind permission of the Director, Geological Survey of India.

Trichinopoly District and also in small patches near Sivganga in Ramanathapuram District.

The well-known lignite fields of Neyveli and its neighbourhood are located between the towns of Vriddhachalam and Cuddalore and occur within the Cuddalore sandstones. The areal extent of the lignite field proved so far by extensive drilling operations is indicated in Fig. 2. The average thickness of the major lignite seam is between 50 and 60 ft. occurring at a depth of about 180 ft. below the ground surface and no seams have been so far encountered further below up to a depth of 500 ft.

Gravity and magnetic surveys were started by the author in the South Arcot District of this coastal belt towards the end of 1954 as the beginning of a systematic geophysical investigation, by the Geological Survey of India, of the entire coastal sedimentary belt of Madras State. The objectives of these investigations are to determine the thickness of the marine sediments and their structural and stratigraphic disposition with a view to assess the possibilities of occurrence of petroleum in this area and to locate additional major lignite beds, if any exist. As can be readily understood, if a large thickness of these sediments can be proved, the geological interest in this area will be considerably enhanced in so far as the possibilities of finding petroleum are concerned.

The gravity observations were made with a modern portable Worden gravimeter while a Watts vertical force magnetometer was used for the magnetic observations. The Bouguer gravity map of the Vriddachalam-Neyveli-Cuddalore areas is shown in Fig. 2.

The Bouguer anomaly map presents three prominent features, namely (i) a steep fall in the gravity values, with a gradient of 7.5 milligals per mile, in the region of the crystalline border to the west of Vriddachalam town, (ii) a pronounced gravity 'low' in the region of the proved lignite field, and (iii) a steep rise to the east of the Neyveli lignite fields towards the seacoast, with a gradient of 2 to 3 milligals per mile. A gravity 'high' of more than 45 milligals is indicated in the Porto Novo area on the seacoast.

The steep fall in the Bouguer gravity values in the neighbourhood of the crystalline-sedimentary boundary, as indicated in Figs. 2 and 3, has the typical appearance of the anomaly arising from a near-vertical fault. This steep fall in the Bouguer values obviously includes the regional anomalies also, but an examination of the gravity profile along the traverse as shown in Fig. 3 clearly shows that the major part of this anomaly is due to a localised, buried geologic feature, such as a fault. Assuming safely a local anomaly of 25 milligals, the downthrow of this fault would be of the order of 3,200 ft. assuming a density

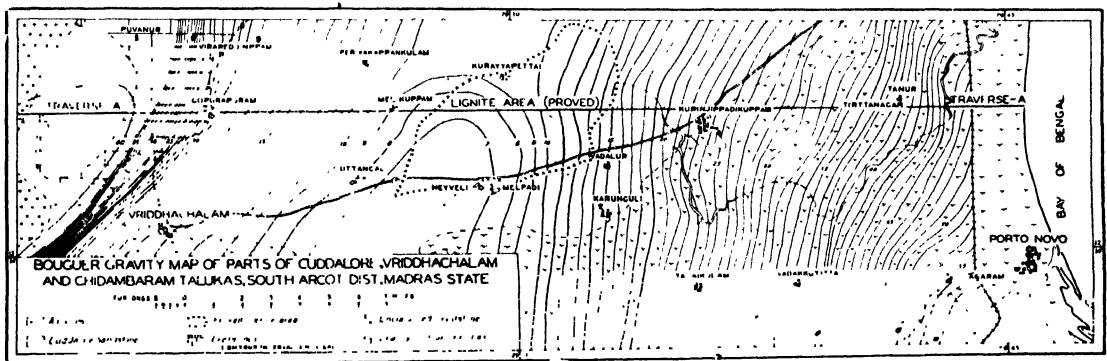

FIG 2

The observations were started in the Cuddalore-Vriddachalam belt, in view of the special interest afforded by the lignite fields of Neyveli and neighbourhood, inasmuch as the presence of the lignite has an important bearing on the gravity observations due to the marked contrast in density between the lignite and the enclosing Cuddalore sandstones,

contrast of 0.6 between the crystalline and sedimentary rocks. The downthrow would be of the order of 4,000 if the density contrast is assumed to be 0.5. Also, the faulting would be down through the crystallines, because the density contrast between the Cretaceous and Tertiary rocks is not large enough to cause such a large gravity anomaly.

Alternatively, however, this gravity anomaly can also be explained by pronounced downwarping, with a steep gradient, of the crystalline basement.

imposed on the strong isostatic regionals, causing distortions in the isogams. A pronounced gravity 'high' is indicated to the south of Porto Novo. While this gravity 'high'

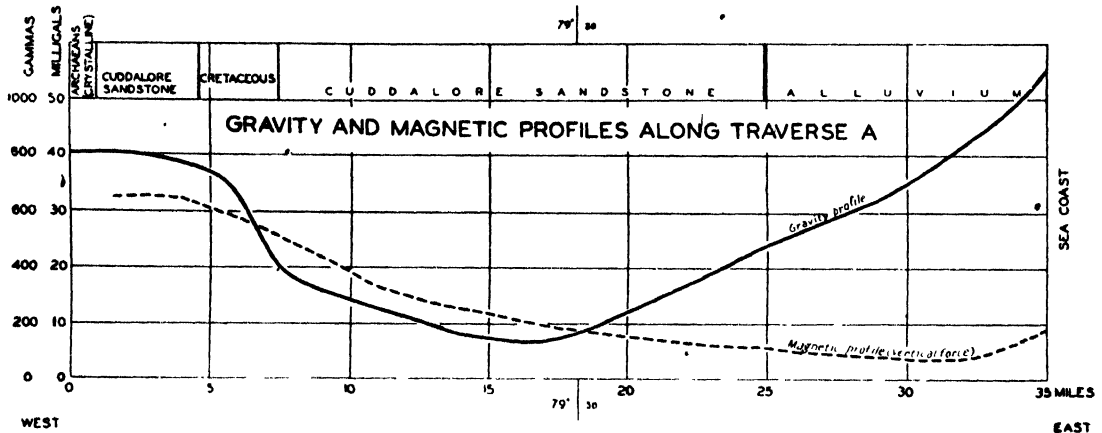

FIG. 3

The second pronounced feature, namely the gravity 'low' in the lignite area to the north of Neyveli, with a fall of more than 35 milligals relative to the values over the crystallines in the west and with a fall of more than 45 milligals relative to the gravity values over the seacoast can be explained, on the basis of rigorous quantitative interpretations only as due to a deepening of the crystalline basement and is not to be attributed to the presence of the lignite which has a low density. The gravity anomaly due to the proved lignite works out to be only a fraction of a milligal and a solid lignite bed of more than 3,000 ft. in thickness will have to be assumed if this gravity low is to be attributed to the lignite. Furthermore, the gravity anomaly is also corroborated by a magnetic 'low' as can be seen from Fig. 3, and, therefore, the evidence for a deepening of the crystalline basement in the Neyveli area is unmistakable. Quantitative interpretations further indicate that the thickness of the sediments in the Neyveli area is not less than 5,000 ft.

East of Neyveli, there is a sudden reversal in the trend of the gravity variations, the gravity values rising steadily, with a steep gradient of 2 to 3 milligals per mile, towards the seacoast. The isogams in this part of the area have the appearance of a typically large isostatic anomaly. A close examination of the isogams in the coastal area (Fig. 2) shows, that there are also local anomalies super-

may be interpreted as indicating the possible rising of the crystalline basement towards the seacoast, it has to be pointed out that the magnetic values, on the other hand, continue their downward trend east of Neyveli with an inappreciable rise on the seacoast which can be readily explained as due to the presence of the coastal sands. A quantitative interpretation of the magnetic anomaly indicates a depth of the order of 8,000 ft. to the crystalline basement in the Tirttanagiri area, a few miles west of the seacoast.

The gravity and magnetic surveys in the coastal sedimentary belt of Madras State are being continued southward along the coast and have now progressed up to the northern bank of the Coleroon river. The pronounced synclinal gravity feature noted in the Neyveli area is found to extend in a north-east to south-west direction over a distance of more than 40 miles from Panruti in the north to Ariyalur and beyond in the south.

A reflection seismic traverse across the coastal belt from the crystalline outcrops on the west to Porto Novo on the east, along the Vriddhachalam-Bhuvanagiri-Porto Novo road is now in progress. The seismic results have confirmed the results of the gravity and magnetic surveys as regards the thickness of the sediments. In the coastal areas, between Bhuvanagiri and Porto Novo, the seismic data indicate an order of thickness of 9,000 ft. for the sediments,

In view of the fairly large thickness of sediments indicated by the Geophysical surveys and the presence of Eocene rocks in the area, the prospect of finding oil in this coastal region of Madras State should now be considered as good.

As the terrain is quite favourable for gravity work, exploration for additional lignite beds in other areas of this coastal tract is quite feasible.

The surveys are in progress and further details will be published in due course.

The author acknowledges his gratitude to all his colleagues who have participated and assisted him in these surveys.

---

1. Kailasam, L. N., *A Preliminary Report on the Gravity and Magnetic Surveys in the South Arcot District, Madras State*, Unpublished Report of the Geological Survey of India, 1956.

---

### SOVIET EDUCATION FOR SCIENCE AND TECHNOLOGY\*

**T**HE book consists of twelve chapters, fifteen appendices and a selected bibliography on the Soviet Educational system. The first eleven chapters may be regarded as summarising, at least in the bulk, very carefully collected factual information regarding the Ten-Year School, the Engineering Technicums, the Higher Education and the Graduate and Research Training as they exist now in the Soviet Union. Sample curricula taken from an Engineering School for Mechanical Engineering, from a University for Physics and a Pedagogical Institute for Mathematics are given in an extensive manner. Important educational problems such as those that relate to Selection, Enrolment, Teachers, Text-Books, Grading, Placement and Facilities are discussed in great detail.

In the final chapter, which is the most important one in the reviewer's opinion, comments and reflections by the author are given. The book is truly "a comprehensive survey of Soviet Education with special emphasis on science and technology" written after much thought and study in the belief that "an examination of the educational process within a given society can provide important clues to an understanding of the moral and intellectual climate in which its people live". The author claims that much of the material that has been examined is equally applicable to the entire range of formal training—if not to education in the broadest sense of the term—in the Soviet Union. This claim is all the more important and significant since the title of the book implies and the data within the book bear out the implication that the detailed figures presented and the conclusions drawn therefrom

are more directly related to those aspects of Soviet Education which deal with the training of Engineers and Scientists only. At that stage one naturally asks the question whether by examining the processes that dominate particular aspects of education in a country, specially of technical education, one is justified in drawing conclusions in regard to the philosophy and motivations behind the entire educational policy of that country. Policies in regard to technical education are naturally shaped by the transient needs of a country but the programmes in regard to general education have a wider meaning and deeper roots.

More than any other country in the world, the U.S.A. today realises the urgent necessity for examining critically and with reference to lasting values, if possible, the Soviet Educational system. Other countries are equally interested in this vital question. Although the author often analyses the issues against the background of the American Educational system, with a view to present Soviet data against a familiar background' as he puts it, he has done valuable service in discussing these issues because the setting up of adequate criteria for judging an educational system is a problem that should interest not one nation or a group of nations but should very well be the concern of mankind as a whole."

In writing the following paragraph,

"Have the measures so actively fostered and supported by the Soviet Government in behalf of science and technology been measures to develop education or to develop training? Indeed, when we talk about the vast Soviet efforts in schools, colleges, and universities, are we talking about education as we Americans and the other free peoples conceive of education? Or are we talking about training, a far narrower concept? And what, then, emerges when we set the Soviet educational system against our own and attempt the inevitable comparisons?"

---

\* *Soviet Education for Science and Technology*. By Alexander G. Korol. (Published jointly by the Technology Press of Massachusetts Institute of Technology and John Wiley and Sons, Inc., New York, Chapman and Hall, Ltd., London), 1958. Pp. xiv+513. Price \$ 8.50.

the author has sought to make a distinction between "education" and "training" and is no doubt partly justified in doing so. The justification is particularly defensible if it is assumed that "the task of American education is infinitely greater, more difficult, and more challenging than that of Soviet education". The tasks of education are, however, universal in character and cannot be very different at different times or in different longitudes. As the author himself accepts, there is, however, no doubt that Soviet education has achieved impressive gains in the quality and quantity of training and to shut one's eyes to these facts is, to say the least, to be under the illusion of

self-complacency. The Soviet system has no doubt implanted into its country's educational machinery certain major strengths as well as major weaknesses but the results achieved do call forth a serious study by all concerned. Mr. Alexander G. Korol has succeeded in outlining the problem in a very thorough and painstaking manner and has included in his book a vast amount of statistical data and carefully collected material, making it an indispensable reading for those who wish to get a picture of education in the Soviet Union

Bangalore-3,  
November 23, 1958.

S. BHAGAVANTAM.

### SYMPOSIUM ON CHEMOTHERAPY IN BACTERIAL AND VIRAL INFECTIONS

**A** THREE-DAY SYMPOSIUM on the above subject was held under the auspices of the C.S.I.R. on the 2nd, 3rd and 4th November at the Central Drug Research Institute, Lucknow. The Symposium was inaugurated by Prof. M. S. Thacker who also laid the foundation-stone of the pilot plant building for producing drugs for trials on a larger scale.

There were two popular lectures: one by Dr. V. R. Khanolkar on "The Chemotherapy of Cancer" and the other by Dr. B. Mukerji on "Indian Medicinal Plants in Experimental Tuberculosis".

Dr. V. R. Khanolkar, Col. S. S. Bhatnagar, Dr. Hawkins and Dr. S. S. Bhatia were the sectional Presidents. The papers presented at the Symposium included one on "Plant Antibiotics" by Dr. Chopra which dealt with *Mycobacterium tuberculosis*, "Perspective of Chemotherapy" by Dr. M. L. Dhar and "The Enzyme Approach to Chemotherapy" by Dr. C. R. Krishnamurthy which dealt with the role of permease in bacterial chemotherapy. There was an interesting paper by Drs. Sheth and Krishnamurthy of Bombay, dealing with the spectacular clinical improvement in cases of pulmonary tuberculosis by the use of powdered fruit of Rudanti (*Capparis monii*). It is hoped

that the value of this drug will be explored further.

There was a paper by the Bengal Immunity group of workers on the chemotherapy of bacillary dysentery, stressing on the possible role of re-excretion of the drug into intestines contrary to the common view that the drug is not absorbed at all and that the beneficial effect is due to its low absorption.

Of the four papers on viral chemotherapy, the one on the methodology by Dr. V. N. Krishnamurthy of Vaccine Institute, Bangalore, emphasised the advisability of using two or more methods even for primary screening of antiviral drugs as against a single test.

There were a few papers on the fungal and parasitic infections and the paper dealing with the method of testing compounds for filariasis, by Dr. Hawkins of London evoked much interest.

The absence of papers on two important aspects of chemotherapy, namely, drug resistance and allergy to antibiotics, was noticeable and this perhaps is significant in the sense that both these problems might not be still acute in our country. The papers, in general, covered much ground eliciting thought-provoking ideas and it should be said that the Symposium was a success.

V. N. K.

### U.S. 'ATLAS' MISSILE

**T**HE successful launching of the 'Atlas' missile marks a distinct step forward in space operations. The missile was fired into orbit from the base at Cape Canaveral, Florida. Its weight is 8,700 lb., length 85 ft. and width 10 ft. It has penetrated 928 miles into outer

space and the lowest point of the orbit is estimated at 114 miles. Its period round the earth is about 100 minutes. It carries a communications system which has proved successful in receiving messages broadcast from the earth and relaying them back.

## EXPLORER IV, FOR INTENSIVE STUDY OF COSMIC RADIATION

**T**HE heaviest American satellite, Explorer IV, launched on 26 July, has a period 110.2 minutes, apogee 1,380 miles and perigee 157 miles. Though of the same size, 80" as Explorers I and III, its weight, 38.43 lb., is heavier by 7 lb. The added weight is in instrumentation. Earlier instruments of previous satellites for temperature and micrometeorite data have been eliminated and the entire payload is devoted to cosmic ray equipment that will provide the most detailed radiation data yet obtained by a U.S. IGY satellite. Included in the instruments are four separate cosmic ray detectors, two radio beacons, one high-power and one low-power, subcarrier oscillators and battery packs.

Of the two GM tubes and two scintillation counters, one of each is shielded to eliminate data below certain energy levels, and the unshielded scintillation counter's data are directed into two radio channels reporting different levels of energy. This gives ground radio stations five channels of information. Thus, it will give not only a wider range of cosmic ray data but will break the information down into levels of intensity. Explorers I and III reported

only the gross amount of radiation they encountered, but did not differentiate between the high-energy and low-energy particles. Thus, out of the 20,000 counts per second reported by them in the high altitude portions of their orbits, it was suspected that a small percentage of these counts was due to high energy particles, but it could not be proved.

Now in Explorer IV, the shielded counters will respond only to the high energy particles, while the unshielded counters will "see" everything. Furthermore, the unshielded scintillation counter is provided with special pick-ups which can further differentiate between energy levels.

Both the high-power and low-power radio beacons will transmit continuously for an expected life of two months. The low-power beacon radiates 10 milliwatts energy and will be used mainly for tracking, but it will also report the same data as the high-power transmitter which radiates 30 milliwatts energy.

Thus the data from Explorer IV, when made available will lead to greater precise knowledge in the study of corpuscular radiation in space (*Science*, 15 August 1958.)

## OBITUARY PROF. W. PAULI

**P**ROFESSOR WOLFGANG PAULI, whose death took place in Zurich, on December 15, 1958, was Professor of Theoretical Physics at Eidgenossische Technische Hochschule, Zurich, since 1928. He was also a member of the Institute for Advanced Study, Princeton, New Jersey, U.S.A., since 1940. He became a naturalized United States citizen in 1946. He was awarded the Nobel Prize in Physics for 1945, for the discovery of the exclusion principle, also called the Pauli principle.

Prof. Pauli was born in Vienna on April 25, 1900. He obtained the Ph.D. from Munich in 1921. Between 1921 and 1928, he was connected with the Universities of Gottingen, Copenhagen and Hamburg. He was a close associate of Prof. Niels Bohr for some time. He also held Visiting Lecturer's post in the Universities of Michigan and Purdue.

The "exclusion principle" for which he was awarded the Nobel Prize was discovered in 1925. "It is to a certain extent supplementary to the quantum theory, but at the same time it occupies an independent position. In its original form, the principle was built on the older quantum theory, which assumed fixed paths for the electrons in the atom. It stated that in every

type of orbit determined by a definite combination of quantum numbers there can be only two electrons and that they must have opposite spins. This principle has proved to be of fundamental importance, not merely as an expression of the empirically discovered distribution of the electrons in the atom, but also for the interpretation of a number of other phenomena, such as the electric conductivity of metals and the properties of magnetic substances. It has been amply confirmed by its applications to the comprehensive observation material concerning the radiation of atoms and has become particularly valuable for the interpretation of the properties of atomic nuclei, as well as the primary particles, protons and neutrons, which make up the nucleus. After the formulation of the new quantum mechanics, Pauli's principle has been given a more general form, and its importance has become more and more obvious."

Prof. Pauli occupied a leading position in theoretical physics and made many outstanding contributions on quantum mechanics and nuclear physics. He received many honours and medals and was elected to learned societies. He was an Honorary Fellow of the Indian Academy of Sciences to which he was elected in 1947.



## LETTERS TO THE EDITOR

FLUORESCENCE REACTION FOR THE  
DETECTION OF BORIC ACID\*

NEELAKANTAM AND ROW<sup>1</sup> introduced resacetophenone as a reagent for detection of boron and boric acid, by a fluorescence test under filtered u.v. light. This reagent possesses certain unique features—a sulphuric acid solution of it is non-fluorescent under filtered u.v. light but with boric acid it yields a bright blue fluorescence. Its limit of sensitiveness in sulphuric acid solution is one in ten thousand and in aqueous phosphoric acid one in one million according to Feigl's method of calculation. If the final volume is taken into consideration, the sensitiveness is increased ten-fold. None of the common basic radicles interfered; the colour of the metallic ion did not interfere as it was invisible under filtered u.v. light. Nitrate and fluoride interfered considerably. Thiosulphate precipitated sulphur but this did not interfere with the test. Chlorate, chromate and ferricyanide oxidised the reagent producing coloured solutions in which, however, the blue fluorescence was visible. In the case of bromide, bro-

the molecule with a view to produce a reagent which could yield the same effect in daylight itself. A few substituted resacetophenones have been synthesised and examined.<sup>1</sup> Results are reported in Table I.

The results show that 5-amino resacetophenone alone yields a result comparable with that of resacetophenone, under filtered ultra-violet light. However, there is no shift from the ultra-violet to the visible region. It is to be noted that even the 1-acyl-2-naphthols<sup>2</sup> gave the fluorescence effect only under ultra-violet light. A mere increase in molecular weight does not bring about any shift of the fluorescence effect into the visible region.

Dept. of Chemistry, N. APPALA RAJU.  
Sri Venkateswara Univ., K. NEELAKANTAM.  
Tirupati, July 23, 1958.

\* This investigation was carried out at Andhra University, Waltair.

1. Neelakantam and Row, *Proc. Int. Acad. Sci.*, 1942, **16A**, 349.

2. Appala Raju and Neelakantam, *Curr. Sci.*, 1951, **20**, 322.

TABLE I

Sl. No.	Reagent	M.P. °C.	Fluorescence			
			Without boric acid		With boric acid	
			Daylight	u.v. light	Daylight	u.v. light
1	4-O-acetyl resacetophenone	.. 75-76	Nil	Nil	Nil	Pale blue
2	5-Nitro-resacetophenone	.. 142	Nil	Nil	Nil	Nil
3	5-Amino-resacetophenone	.. 240-42	Nil	Nil	Nil	Intense bright blue
4	Monobromo-resacetophenone	.. 176	Nil	Nil	Pale yellow	Deeper yellow
5	2 : 4-Diacetyl resorcinol	.. 85-87	Nil	Nil	Nil	Pale yellow
6	4 : 6-Diacetyl resorcinol	.. 180	Nil	Nil	Nil	do.
7	Dinitro-resacetophenone	.. 164	Nil	Nil	Nil	Nil

mine was liberated and the latter brought about bromination of the compound which markedly reduced the intensity of fluorescence. With iodide, the separation of iodine rendered observation difficult. Tartrate underwent carbonisation but the consequent difficulty in observation of fluorescence was reduced by diluting the solution with more acid.

The chief drawback of this reagent, however, is the necessity of working under filtered u.v. light in a dark room. It is, therefore, desirable to investigate the effect of substitution of

## NOR-PONGAMOL FROM PONGAMOL

METHODS<sup>1</sup> of demethylation of pongamol (I) using hydriodic acid or anhydrous aluminium chloride, have led to the formation of either furano (2' : 3' : 7 : 8) chromone (II) or a more complex compound and in no case nor-pongamol (III) was obtained. Using magnesium iodide in dry ether solution according to the procedure given below, we have been able to obtain besides the furanochromone, nor-ponga-

mol, whose structure has been established as 5-*o*-benzoacetyl-4-hydroxy-benzofuran (III) by two independent methods: (1) a direct synthesis using 5-acetyl-4-hydroxy-benzofuran (V) and passing through 5-acetyl-4-benzoyloxy-benzofuran (IV) and (2) by cyclising it to give (II) whose identity with furano (2' : 3' : 7 : 8) flavone was established by comparison with an authentic sample obtained by the demethylation of pongamol using hydriodic acid.

Pongamol (1 g., 1 mol.) dissolved in dry benzene (50 ml.) was treated with magnesium iodide (61 g., 1 mol.) in dry ether (50 ml.) with

Starting from 5-acetyl-4-hydroxy-benzofuran<sup>2</sup> (V), nor-pongamol<sup>1</sup> was synthesised passing through the stage 5-acetyl-4-benzoyloxy-benzofuran (m.p. 100-02° C. d. with previous sintering) using benzoyl chloride and pyridine (Found: C, 73.2; H, 4.6; C<sub>17</sub>H<sub>12</sub>O<sub>4</sub> requires C, 73.0 and H, 4.3%) which was subsequently subjected to a sodamide migration to give nor-pongamol. By boiling nor-pongamol in glacial acetic acid solution with anhydrous sodium acetate, furano (2' : 3' : 7 : 8) flavone was obtained, the identity of which was established by a mixed melting point.

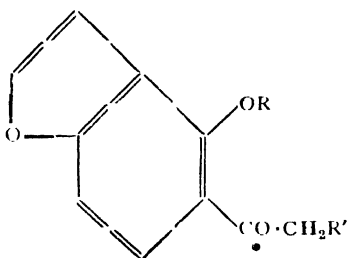

(I, R. CH<sub>3</sub>; R'. COC<sub>6</sub>H<sub>5</sub>)  
(III, R. H, R'. COC<sub>6</sub>H<sub>5</sub>)  
(IV, R. COC<sub>6</sub>H<sub>5</sub>; R'. H)  
(V, R: R'. H)

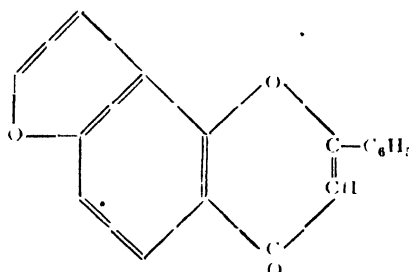

II

immediate precipitation. The solvents were then removed under suction, temperature then raised to 150° C. during half-hour and maintained at that temperature for another half-hour. The cooled pale brown mass was then decomposed with cold dilute sulphuric acid, filtered and then washed with sodium bisulphite solution. The residue in ether solution was then treated with copper acetate and the copper complex (A) which completely precipitated during half hour [copper complex (A), m.p. 278-80° C. after one crystallisation from dioxan] was separated from the ether solution (B) and decomposed using dilute sulphuric acid. Nor-pongamol was obtained as pale yellow prisms from methanol, m.p. 141-43° C., with an intense purple ferric reaction. (Found: C, 73.0; H, 4.4; C<sub>17</sub>H<sub>12</sub>O<sub>4</sub> requires C, 72.9 and H, 4.3%) A mixed melting point with an authentic sample of furano (2' : 3' : 7 : 8) flavone is depressed.

Evaporation of the ether solution (B), left a residue, which melted at 146-47° after one sublimation, having no positive ferric reaction. A mixed melting point with an authentic sample of furano (2' : 3' : 7 : 8) flavone was un-depressed.

C. BHEEMASANKARA RAO.  
V. VENKATESWARLU.

Dept. of Chemistry,  
Andhra University,  
Waltair, June 26, 1958.

- 1 Rangaswamy, S. and Seshadri, T. R., *Proc. Ind. Acad. Sci.*, 1942, **15A**, 417; Narayanaswamy, S., Rangaswami S. and Seshadri, T. R., *J.C.S.*, 1954, 1871; Krishnaswamy, B. and Seshadri T. R., *Proc. Ind. Acad. Sci.*, 1942, **15A**, 437.
- 2 Bheemasankara Rao, C. and Venkateswarlu, V., *Curr. Sci.*, 1956, **25**, 357.

**FURTHER STUDIES ON THE  
INFLUENCE OF THYROXINE AND  
TRIIODOTHYRONINE ON THE  
GROWTH AND METABOLIC  
PROCESSES IN THE RICE MOTH  
LARVAE (*CORCYRA CEPHALONICA* ST.)**

THYROXINE and its active analogues have recently been shown to have a marked growth-promoting effect when included in the diet of the rice moth larvae.<sup>1,2</sup> Feeding of thyroid preparations to rats is known to be accompanied by weight loss, and supplementation of vitamin B<sub>12</sub> to the diet has been shown to afford

protection against such a loss in weight.<sup>5-5</sup> Further, administration of thyroid preparations to rats is known to profoundly influence the activity of several enzyme systems.<sup>6</sup> In the present investigation it has been shown that vitamin B<sub>12</sub> counteracts the growth-promoting activity of thyroxine and triiodothyronine and that feeding thyroxine, triiodothyronine and thyroxamine to rice moth larvæ results in a decrease in the activity of the enzymes catalase and amylase.

The experimental technique adopted was essentially the same as described earlier.<sup>2</sup> Thyroxine was added at a level of 2.0 µg. per gm. of diet, whereas triiodothyronine was added at two levels, 0.2 µg. per gm. of diet and 2.0 µg. per gm. of diet. Vitamin B<sub>12</sub> was included at the level of 1.0 µg. per gm. of diet. The results are presented in Table I.

TABLE I

*Effect of Vitamin B<sub>12</sub> on the growth of rice moth larvæ fed thyroxine and triiodothyronine*

Concentration of thyroxine or triiodothyronine (µg./gm. diet)	Concentration of vitamin B <sub>12</sub> (µg./gm. of diet)	Weight of 10 larvæ at the end of 20 days (growth mg.)
..	..	200
0.0	0.5	228
0.0	1.0	233
2.0 thyroxine	..	327
2.0 "	1.0	167
0.2 triiodothyronine	..	365
0.2 "	1.0	244
2.0 "	..	284
2.0 "	1.0	228

For studying the influence of thyroxine, triiodothyronine or thyroxamine on the level of catalase, 50 mg. of the larvæ at the end of the experimental feeding period of 15 days, were finely ground in 50 ml. of M/15 phosphate buffer (pH 7.0), whereas for amylase, 50 mg. of larvæ were ground in 5 ml. of M/15

phosphate buffer (pH 7.2). The catalase assay consisted in adding appropriate volumes of enzyme extract to 5 ml. of 0.05 M hydrogen peroxide at definite time intervals. The reaction was stopped exactly at the end of the 5th minute by the addition of 5 ml. of 2 N sulphuric acid. The residuary hydrogen peroxide was titrated against N/200 potassium permanganate. Each sample was assayed in quadruplicates and appropriate blanks were included. Amylase activity was determined according to the method of Smith and Roe.<sup>7</sup> The results of this investigation are presented in Table II.

From the results presented in Table I it can be observed that vitamin B<sub>12</sub> counteracts the growth-promoting action of thyroxine and triiodothyronine. The feeding of vitamin B<sub>12</sub> alone at the levels tested, has no growth-inhibitory effect, rather, it stimulates growth to a slight extent. It can be recalled here that vitamin B<sub>12</sub> supplementation has been shown to afford protection against the toxicity of thyroxine feeding in higher animals.<sup>3-5</sup> The results of the present experiment thus suggest the possibility of a direct antagonism existing between the action of vitamin B<sub>12</sub> and thyroid hormone. Thyroxine in very small amounts has been used to improve the growth rate of young chicks<sup>8</sup> and it is also known to have a stimulatory effect on the growth of young immature rats. It may be of interest to study the effect of vitamin B<sub>12</sub> in such of these cases where thyroid feeding stimulates growth. The data presented in Table II make it clear that the activities of both catalase and amylase are appreciably decreased in the thyroid hormone-supplemented group. In mammals, thyroxine administration has been observed to diminish catalase<sup>9</sup> and amylase activities.<sup>10-12</sup> It is evident from this, that *Corcyra* reacts to thyroxine supplementation in a manner similar to higher

TABLE II

*Influence of thyroid hormone supplementation on the catalase and amylase activity of Corcyra*

Supplement added	Amount added µg./gm diet	Catalase units*	% Deviation from control	Amylase units†	% Deviation from control
Control	.. No supplement	564.5	..	1100	..
Thyroxine	.. 2.0	264.6	-53	692	-37
Triiodothyronine	.. 0.1	271.0	-48	803	-27
Thyroxamine	.. 3.0	260.0	-54	589	-46

\* Catalase unit: ml. of N/100 potassium permanganate consumed per gm. of tissue per minute.

† Amylase unit (Smith and Roe): mg. of starch hydrolysed by 1 gm. of tissue in 30 minutes.

animals. Hitherto, in higher animals it has not been possible to show beyond doubt whether the changes in activities of many enzyme systems observed in thyrotoxicosis are all due to a direct action of thyroid hormone, or are due to a generalised influence on body processes following an imbalance of the entire endocrine set-up. The similarity of *Corcyra* to mammals in reacting in the same way to thyroxine administration can thus be made use of in studying the specificity of the action of thyroid hormone on enzyme systems common to *Corcyra* and mammals. This is specially significant when it is pointed out that in investigations with an organism like *Corcyra* interference due to other vertebrate endocrine secretions can be eliminated.

Triiodothyronine, though supplemented at a very low concentration when compared with thyroxine, produces about the same decrease in enzyme activities. The fact that throxamine is as powerful as thyroxine in decreasing the enzyme activities of *Corcyra* lends further support to the suggestion<sup>2,3</sup> that lower organisms are unable to differentiate any slight change in the alanine side chain of thyroxine moiety.

The authors wish to thank Hoffman-la-Roche Ltd., Basle, Switzerland, for the sample of thyroxamine used in this investigation.

University Biochem. Lab., N. R. MOUDGAL.  
Madras-25, E. RAGHUPATHY.  
July 8, 1958. R. S. SARMA.

1. Srinivasan, V., Moudgal, N. R. and Sarma, P. S., *Science*, 1955, **122**, 644.
2. Moudgal, N. R., Raghupathy, E. and Sarma, P. S., *Nature*, 1958, **181**, 1655.
3. Bethell, J. J. and Lardy, H. A., *J. Nutrition*, 1949, **37**, 495.
4. Sure, B. and Easterling, L., *Ibid.*, 1950, **42**, 221.
5. Tappan, D. V., Lewis, U. J., Register, U. D. and Elvehjem, C. A., *Arch. Biochem.*, 1950, **29**, 408.
6. Barker, S. B., *Physiol. Revs.*, 1951, **31**, 205.
7. Smith, B. W. and Roe, J. H., *J. Biol. Chem.*, 1949, **179**, 53.
8. Reinke, E. P., *Vitamins & Hormones*, Acad. Press, Inc., N.Y., 1946, **4**, 245.
9. Ramachandran, L. K. and Sarma P. S., *J. Sci. Ind. Res.*, 1954, **13B**, 115.
10. Scoz, G., *Bull. Soc. Biol. Ital.*, Sper. 1934, **9**, 971.
11. Bartlett, W., Jr., *Proc. Soc. Exptl. Biol. Med.*, 1937, **36**, 843.
12. Grad, B. and Leblond, C. P., *Endocrinology*, 1949, **45**, 250.
13. Pitt-Rivers, R., *Jour. Clin. Endocrinol. Metab.*, 1954, **XIV**, 1444.

### THE CONDENSING ENZYME IN GARCENIA LEAVES (*XANTHOCHYMUS GUTTIFERAE*)

THE widespread presence of the condensing enzyme in animal tissues has been adequately demonstrated.<sup>1</sup> While its presence in yeast, bacteria and moulds has been detected,<sup>2,3</sup> few investigations have been reported about its occurrence in plant tissues. As citric acid is known to accumulate in several plant tissues like *Garcenia* (*Xanthochymus guttiferæ*), it becomes of interest to investigate the occurrence or otherwise of the condensing enzyme in such tissues. The present note reports the occurrence of the condensing enzyme in *Garcenia* leaves.

*Garcenia* leaves were kept under ice immediately on removal from the tree and all subsequent operations carried out at 0° C. The central nerves of the leaves were removed (leaves in which the latex oozed out were discarded as the latex was found to inhibit the enzyme) and the remaining parts were cut into very thin pieces and ground in a chilled mortar for 15 minutes at 0° C. with one-third the weight of alumina and twice the volume of 0.02 M phosphate buffer, pH 7.2. The extract was separated from the debris by centrifugation for 15 minutes at 12,000 r.p.m. and at 0° C. Ammonium sulphate precipitation and gel adsorption techniques were used to obtain a highly purified fraction. This fraction was used for the experiment.

Ammonium sulphate fraction of an extract of *E. coli*, N.R.C. 428, prepared according to the method of Ramakrishnan and Martin,<sup>3</sup> was used as a source of transacetylase.

Citric acid was determined quantitatively by the method of Saffran and Denstedt.<sup>4</sup> Qualitative identification of the acid was made by the paper chromatographic technique described by Varma and Ramakrishnan.<sup>5</sup>

One millilitre of the complete system for condensing enzyme assay contained 10 μM of phosphate buffer, pH 7; 8 μM of MgCl<sub>2</sub>; 12 units of CoA,\* 10 μM of cysteine hydrochloride; 8 μM of dilithium acetyl phosphate, 0.04 ml. of transacetylase preparation (9 mg./ml.). 20 μM of OAA, enzyme preparation and water to make the final volume to 1 millilitre. The temperature of incubation was 30° C. This is essentially the same system as was used by Ochoa, Stern and Schneider.<sup>6</sup>

The enzyme preparation readily catalysed the synthesis of citrate from acetyl phosphate, CoA,

\* CoA, Coenzyme A; OAA, Oxalacetate; CSH, Cysteine hydrochloride; Ac-P, Acetyl phosphate.

and oxalacetate in presence of a source of trans-acetylase.

The authors express their thanks to the Head of the Botany Department, Baroda University,

TABLE I  
Citrate synthesising system in leaves of *Xanthochymus guttiferæ*  
requirements for enzyme activity\*

Complete system	Deletion from complete system							
	Phosphate	MgCl <sub>2</sub>	CoA	CSH	A-P	OAA	Enzyme	Trans-acetylase
μM Citrate formed	·11	·08	·05	·02	·02	0·0	0·0	·04

\* The system was incubated for 40 minutes at 30° C.

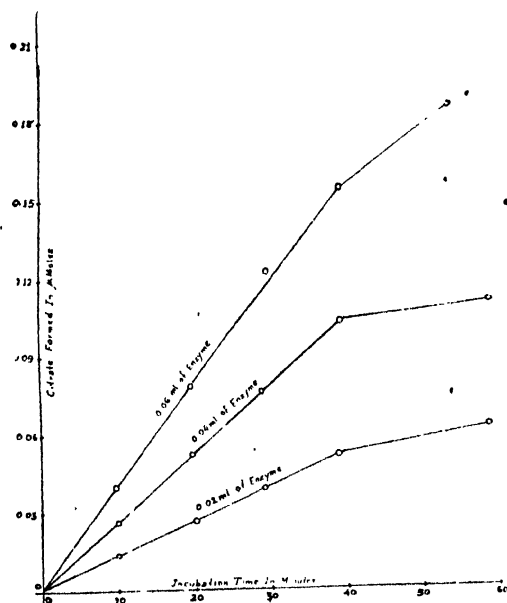

FIG. 1. Effect of enzyme concentration and period of incubation on condensing enzyme.

Fig. 1 illustrates the dependence of citrate synthesis on enzyme concentration and time of incubation.

The requirement for the various components of the system is shown in Table I.

The data presented demonstrate conclusively the presence of the condensing enzyme in *Garcinia* leaves. This lends support to the hypothesis that citric acid may be synthesised, at least in part, through the condensation of active acetate and oxalacetate. Details of the purification and characteristics of the condensing enzyme will be published elsewhere.

for having allowed them to use the leaves from the Botany Garden, and to Miss Mary Clemens, Division of Applied Biology, National Research Council of Canada, for the gift of lyophilised *E. coli*. One of the authors (W. M. D.) acknowledges the receipt of a Research Training Scholarship from the Ministry of Education, Government of India.

Biochemistry Dept., W. M. DESHPANDE.  
Baroda University, C. V. RAMAKRISHNAN.  
Baroda, India, July 21, 1958.

1. Stern, J. R. and Ochoa, S., *Jour. Biol. Chem.*, 1949, **179**, 491.
2. Novelli, G. D., and Lipmann, F., *Ibid.*, 1950, **182**, 213.
3. Ramakrishnan, C. V., and Martin, S. M., *Chem. and Indus.*, 1954, 160.
4. Saffran, M. and Denstedt, D. F., *Jour. Biol. Chem.*, 1948, **175**, 849.
5. Varma, T. N. S. and Ramakrishnan, C. V., *Curr. Sci.*, 1956, **25**, 395.
6. Ochoa, S., Stern, J. R. and Schneider, M. C., *Jour. Biol. Chem.*, 1951, **193**, 691.

#### DETERMINATION OF BLOOD SUGAR USING 0.02 ml. OF FINGERTIP BLOOD

MILLER AND VAN SLYKE,<sup>1</sup> AND SOMMOGYI<sup>2</sup> reported about the differences in the blood sugar levels in capillary and venous blood. They found that the capillary blood sugar was higher than that of the venous blood.

The present investigation is aimed at developing a suitable micro-method for the determination of blood sugar in fingertip blood and to study the variations in the blood sugar levels in samples under normal and pathological states.

In a series of twenty-five preliminary observations with normal subjects under fasting conditions the fingertip blood sugar was determined using 0.02 ml. of blood obtained from the ring fingers of the left hands by a sharp prick with a triangular needle. The Hagedorn and Jensen's<sup>3</sup> method was utilized for these determinations with suitable modifications as follows:

In each of two centrifuge tubes was taken 1 ml. of 0.45% zinc sulphate and 0.02 ml. of 0.1 N sodium hydroxide solution and mixed; 0.02 ml. of blood drawn directly from a fingerprick into a Hellige micropipette was then blown into one of these tubes, the other tube being kept as a blank. The micropipette was washed twice with the fluid in the tube and both the tubes were kept in a boiling water-bath for 2 min., cooled and centrifuged in an electric centrifuge at 2,000 r.p.m. for 2 min. The supernatant fluids were carefully decanted off into two 50 ml. conical flasks, the precipitates washed twice with 2 c.c. portions of distilled-water, centrifuged and the washings added to the respective conical flasks. Two ml. of a standard potassium ferricyanide solution was now added to each of these

iodine-sulphate solution followed by 2 ml. of 3% acetic acid solution was added to each of these flasks. The solutions were then immediately titrated against 0.005 N sodium thio-sulphate solution using starch as the indicator.

The figure representing ml. of thiosulphate required for the blank minus ml. required for the blood sample was calculated and the blood sugar value corresponding to this figure was directly read off from the reference curve (Fig. 1) which was previously drawn by using the same reagents and procedures but substituting 0.02 ml. of blood by the same volume of a number of standard glucose (A.R.) solutions of varying concentrations.

The fasting blood sugar values obtained by this method in 25 normal subjects ranged from 102-120 mg./100 c.c. of blood.

Biochem. Lab., H. D. BRAHMACHARI,  
Birla College, Pilani, MAHENDRA KUMAR.\*  
Rajasthan. June 9, 1958.

\* Government of India Research Scholar (Senior).

1 Miller, B. F. and Van Slyke, D. D., *J. Biol. Chem.* 1936, **114**, 583.

2 Somogyi, M., *Ibid.*, 1948, **174**, 189.

3 Hagedorn and Jensen, *Biochem. Z.*, 1923, **135**, 46

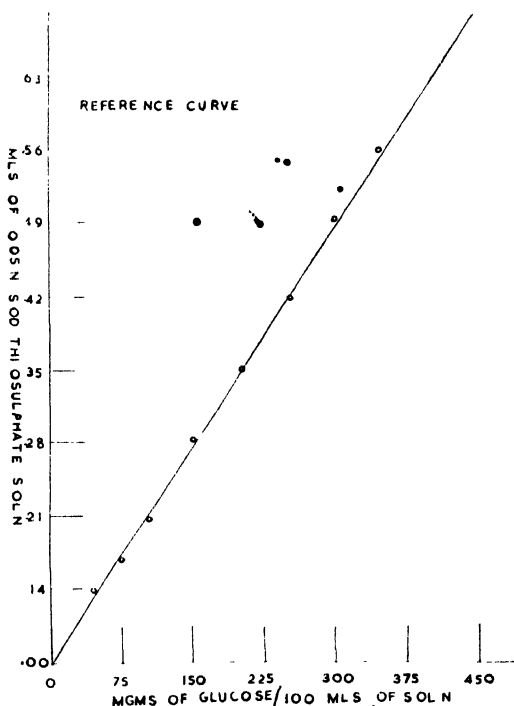

FIG. 1

conical flasks, which were then placed on a boiling water-bath for exactly 10 min. After heating, the flasks were cooled and 3 ml. of an

### DETECTION OF ACETYL CoA DEACYLASE IN CITRIC ACID PRODUCING STRAIN OF ASPERGILLUS NIGER

INVESTIGATIONS carried out recently in this laboratory on the mechanism of formation of citric acid in *A. niger* led to the observation that, during the early stages of fermentation of this mold no citric acid was formed despite the presence of several citrate synthesising enzymes such as the condensing enzyme, oxalacetic carboxylase, pyruvic oxidase, etc.<sup>1-3</sup> This led the authors to suspect that there might be a formation of C<sub>2</sub> and C<sub>4</sub> acids which, however, might be hydrolysed as soon as they are formed by some powerful hydrolysing enzyme systems thus preventing the formation of sufficient amounts of substrates necessary for the synthesis of citrate. Studies were therefore undertaken in this laboratory to investigate the presence of these hydrolysing enzymes in cell-free extracts of *A. niger* during the early stages of fermentation. The detection of one such enzyme, namely, oxalacetic hydrolase, has already been reported.<sup>1</sup> The presence of another such enzyme, namely, acetyl CoA deacylase, which hydrolyses the active acetate formed, has now been detected.

*Aspergillus niger*, NCIM 611 was grown in a synthetic medium used by Damodaran, Jagannathan and Kartar Singh.<sup>5</sup> After 72 hr. of incubation, the mold mat was washed well with ice cold 0.02 M phosphate buffer, pH 7.0 and ground in a chilled mortar for 30 min. at 0° C. with equal weight of alumina (Alco A. 301) and four times its volume of 0.02 M phosphate buffer, pH 7.0. The extract was separated from the debris by centrifugation for 15 min. at 12,000 r.p.m. and at 0° C. Ammonium sulphate precipitation and gel adsorption techniques were used to obtain a highly purified fraction. This fraction was tested for acetyl CoA deacylase activity.

1.5 millilitre of the complete assay system contained 100  $\mu$ M glycine buffer, pH 6.8; 4  $\mu$ M of  $MgCl_2$ ; 12 units of coenzyme A, 2  $\mu$ M of cysteine hydrochloride; 8  $\mu$ M of dilithium acetyl phosphote; 0.1 ml. of transacetylase preparation (9 mg./ml.); 1  $\mu$ M of sodium fluoride, 0.04 ml. of enzyme preparation and water to make the final volume to 1.5 millilitre. Blanks without CoA and phosphotransacetylase were run. All were incubated for 40 min. at 26° C. and acetyl phosphate left over was determined by the method of Lipmann and Tuttle.<sup>6</sup> Sodium fluoride was used to suppress any phosphatase activity.

Ammonium sulphate fraction of *E. coli*, N.R.C., 428 prepared according to the method of Ramakrishnan and Martin<sup>7</sup> was used as a source of transacetylase.

One unit of enzyme activity is defined as the amount of enzyme required in order to effect the disappearance of 1  $\mu$ M of acetyl phosphate under experimental conditions.

The enzyme preparation readily catalysed the hydrolysis of acetyl phosphate in presence of CoA and transacetylase.

Fig. 1 illustrates the dependence of acetyl CoA deacylase activity on the enzyme concentration and time of incubation.

Studies carried out on the requirements for the various components of the enzyme system show that acetyl phosphate does not disappear with the omission of deacylase coenzyme A, transacetylase and acetyl phosphate in the component system whereas its disappearance is less with the omission of sodium fluoride, magnesium chloride and cysteine hydrochloride (0.53  $\mu$ M\* acetyl phosphate disappears in complete system whereas 0.31, 0.12 and 0.42  $\mu$ M of acetyl phosphate disappear in absence of sodium fluoride, magnesium chloride and cysteine hydrochloride).

The data presented demonstrate conclusively the presence of the acetyl CoA deacylase in cell-free extracts obtained from 3-day-old mat of *A. niger*. The high activity of this enzyme in *A. niger* during early stages of fermentation when no citric acid accumulates and its very

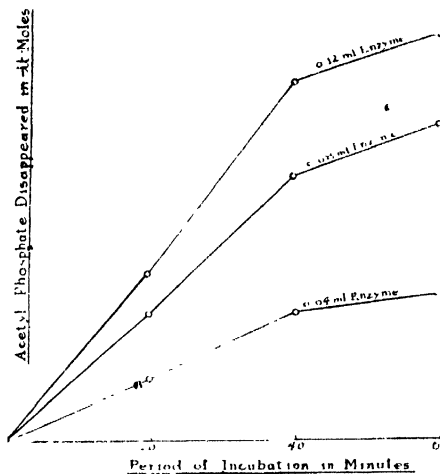

FIG. 1. Effect of enzyme concentration on the activity of acetyl CoA deacylase

low activity during later stages when citric acid accumulates<sup>8</sup> suggests that, during early stages of fermentation, this enzyme hydrolyses the acetyl CoA formed thus preventing it from combining with  $C_4$  acid to form citrate. Details of the purification and characteristics of acetyl CoA deacylase will be published elsewhere.

Biochemistry Dept., C. V. RAMAKRISHNAN,  
Baroda University, P. N. RAINA,  
Baroda, India,  
July 29, 1958.

\* 0.04 ml. of the enzyme was used.

1. Ramakrishnan, C. V. and Martin, S. M., *Can. J. Biochem. and Physiol.*, 1954, **32**, 434.
2. Joshi A. P. and Ramakrishnan, C. V., *J. Sci. and Indus. Res.*, 1958 (in Press).
3. Ramakrishnan, C. V., *Enzymologia*, 1954, **7**, 169.
4. Joshi, A. P. and Ramakrishnan, C. V., *J. Sci. and Indus. Res.*, 1958 (in Press).
5. Damodaran, M., Jagannathan, V. and Kartar Singh, *Enzymologia*, 1955, **17**, 190.
6. Lipmann, F. and Tuttle, L. C., *J. Biol. Chem.*, 1945, **159**, 21.
7. Ramakrishnan, C. V. and Martin, S. M., *Chem. and Indus.*, 1954, 160.
8. Ramakrishnan, C. V., Communicated to *Arch. Biochem. and Biophys.*

**ON THE SUGAR CONSTITUENTS OF  
PROCERANIN, SAPONIN OF  
ALBIZZIA PROCERA BENTH.**

IN a recent communication to the Academy of Sciences, Paris,<sup>1</sup> the presence of a new saponin, proceranin, m.p. 156-58°, in *Albizzia procera* Benth. seeds has been reported. The saponin obtained by the hydrolysis of this saponin has been characterised as machærinic acid ( $\Delta^{12-3} \beta-21 \xi$ -dihydroxy-18  $\beta$ -oleanene-28-oic acid) in contrast to the presence of echinocystic acid (16  $\alpha$ -hydroxy oleanolic acid) and oleanolic acid in *Albizzia lebbek* Benth.<sup>2</sup> and echinocystic acid in *Albizzia althelmintica*.<sup>3</sup>

The solution of the sugars obtained after the hydrolysis of the saponin, proceranin, with sulphuric acid was neutralised with freshly precipitated barium carbonate and the neutral filtrate obtained after the removal of barium sulphate was evaporated to dryness in a vacuum oven at 35-40° C. The syrupy residue left over was dissolved in a few drops of water and chromatographed alongside, with authentic sugars using Whatman filter-paper No. 1 and butanol : ethanol : water (4 : 1.1 : 1.9),<sup>4</sup> as solvent mixture using the descending technique The spots were revealed by spraying with *p*-anisidine phosphate<sup>5</sup> and aniline hydrogen phthalate.<sup>6</sup> It showed the presence of four sugars, *d*-glucose, *d*-arabinose, *d*-xylose and *l*-rhamnose. Similar results were obtained when the acid hydrolysate was passed through a column of Amberlite IRA 400 and paper chromatographed. It may be mentioned that the presence of a large number of different sugars in saponin of this class (triterpenic) is not rare (cf. *Randia dumetorum*<sup>7</sup> and *Albizzia lebbek* Benth.<sup>8</sup>).

Dept. of Chemistry,  
Muslim University,  
Aligarh, June 25, 1958.

M. O. FAROOQ.  
I. P. VARSHNEY.  
HAMEEDUL HASAN.

1. Farooq, M. O., Varshney, I. P. and Hameedul Hasan, *Compt. rend. Acad. Sciences*, Paris, 1958, **246**, 3261-63.
2. Ch. Sannié, Lapin, H. and Varshney, I. P., *Bull. Soc. Chim. France*, 1957, 1440-44; Varshney, I. P., *D. Sc. Thesis, University of Paris*, soutenue le 21-12-1956.
3. Tschesche, R. and Fortsmann, D., *Ber.*, 1957, **90**, 2383-94.
4. Hough, L. and Jones, J. K. N., *J. Chem. Soc.*, 1950, 1702.
5. Mukherjee, S. and Srivastava, H. C., *Nature*, 1952, **169**, 330.
6. Partidge, S. M., *Ibid.*, 1949, **164**, 445.
7. Varshney, I. P. and Ch. Sannié, *Compt. rend. Acad. Sciences*, Paris, 1956, **242**, 2393-95.
8. Varshney, I. P. (unpublished results).

**EFFECT OF HUMUS OF LEGUME AND  
NON-LEGUME ORIGIN ON THE  
NITROGEN FIXATION IN  
AZOTOBACTER CHROOCOCCUM**

HUMUS is known to have remarkable stimulatory effect on microbiological activities in soil.<sup>1-4</sup> Recently an investigation was carried out to see if difference in the origin of soil humus affected nitrogen fixation by *Azotobacter chroococcum* differently.

Two lb. of Delhi soil\* sieved through a 2 mm. sieve were mixed with 5% of its weight of the dried and pulverised leaves and stems of the respective plants under study. The latter included three legumes, guar (*Cyamopsis psoralioides*), dhaincha (*Sesbania aculeata*), sunn-hemp (*Crotolaria juncea*), and two cereals, maize (*Zea mays*) and paddy (*Oryza sativa*). After making up the moisture to one-third the saturation capacity, the soils were maintained in pots at room temperature, for two months for decomposition of the plant material in the soil and formation of humus. At the end of this period, the soils were taken out from the pots, air-dried and the humus isolated by the method of Sprengel.<sup>6</sup> The humus so obtained was suspended in water and made upto a suitable volume. The concentration of the humus in the suspensions and the nitrogen and the carbon content of suitable aliquots were determined. Seventeen mg. of the humus were added to 100 ml. of Fred and Waksman's medium<sup>5</sup> and inoculated with a strain of *Azotobacter chroococcum*, isolated from Delhi soil. The amount of nitrogen fixed by the organism after incubation of 21 days at 32.5° C. was determined by Kjeldahl's method.

The composition of the humus obtained from decomposition of different plant materials in Delhi soil is given in Table I and the relative

TABLE I  
Composition of humus from different plant materials

(Constituents expressed as percent. on moisture-free basis)

Material	C	N	C/N
Soil humus (from untreated soil)	57.00	8.70	6.55
Guar humus	57.62	5.47	10.47
Dhaincha humus	58.09	6.24	9.31
Sunn-hemp do.	58.14	7.16	8.12
Maize do.	58.09	8.53	6.81
Paddy do.	58.02	5.18	11.20



amounts of nitrogen fixed by *Azotobacter chroococcum* with humus of different origin are given in Table II.

TABLE II  
Effect of humus of different origin on nitrogen fixation by *Azotobacter chroococcum*

(Each N-figure is an average of 3 determinations)

Material	Nitrogen fixed (mg./gm. mannite)
Control (set without humus)	6.23
Soil humus	7.73
Guar humus	10.90
Dhaincha humus	8.37
Sunnhemp do.	8.93
Maize do.	7.70
Paddy do.	7.87

Significant at 1 per cent.

C.D. at 1 per cent. = 0.23.

Guar Sunnhemp Dhaincha Paddy Maize Soil Control

It may be observed from the data in Table I that both humus from guar and paddy had lower contents of nitrogen but higher C/N ratios than the humus from other plant materials.

However, the amount of nitrogen fixation by *Azotobacter* in culture solutions was highest with humus from guar. This was followed by the sets treated with humus from sunnhemp and dhaincha. Humus from the cereals, maize and paddy accelerated nitrogen fixation by *Azotobacter* only to the extent accomplished by humus from untreated soil, as compared to control (set without humus). The different amounts of nitrogen fixed could not be correlated with the carbon or nitrogen values or their ratios.

The author's thanks are due to Dr. B. P. Pal, Director, I.A.R.I., New Delhi, for permission to publish this note, and to Dr. R. V. Tamhane for encouragement during the course of this work.

Indian Agric. Res. Inst., V. ISWARAN.  
New Delhi, July 12, 1958.

## GRANITE-PAKHAL RELATIONSHIP (YELLANDLAPAD AREA)

THE Pakhal rocks occupy considerable areas in parts of Khammam and Warangal Districts of Andhra Pradesh (Toposheets No. 65 C/NW and 65 C/NE) and they consist of quartzitic sandstones, clayslates and limestones. Around the Yellandlapad region they are further metamorphosed to quartzites, phyllites, schists and marbles. Their outcrops are separated by 3 granitic bays, viz., the Karepalli, Yellandlapad and Bethampudi bays. From their geological setting, structural features and lithology, William King<sup>1</sup> correlated these rocks with the Cuddapahs. Subsequently they were studied in detail by Mahadevan<sup>2</sup> and Heron.<sup>3</sup> While Mahadevan thinks that Pakhals are really of middle Dharwar age similar to the Gangpur series of Orissa and that the three granitic bays are younger intrusions, Heron is of the view that they should be correlated to the Cuddapahs resting on the Peninsular gneisses, since in their type area and all along to the east of Muner River they do not exhibit any high degree of metamorphism. It is only in the Yellandlapad region that the rocks show intense metamorphism, and the Pakhal-granite relationships are complicated and these are supposed to be due to deep folding, down buckling, migmatization, remelting and so on.

The author during a course of detailed field examination of the Pakhal-granite relationships in an area of nearly 150 sq. miles found that the rocks are dominantly phyllitic, with subordinate crystalline limestones and quartzites. At places the phyllites have been converted into schists. All the rocks have roughly a NE strike at times changing to a NW or even WNW and have a high south-easterly dip of 60° to 80°.

Studies in the field and laboratory of the so-called granites show that they are more like migmatites with only subordinate granite, thus supporting Read's contention that there is a very close association in the field of metamorphic, migmatitic and granitic rocks (his Plutonic series) and they are very much foliated. Close observation has further revealed that these granites, including the migmatites, are quite possibly highly metamorphosed Pakhal phyllites. At several places, transition can be seen in which the phyllites are altering into schists and these in turn into gneisses. Felspathisation is taking place along the foliation planes of the schists and in some cases feldspar ovoids, both pink and

1. Mockridge, F. A., *Proc. Roy. Soc.*, Ser. B, 1917, **89**, 508-32.
2. —, *Ann. Bot.*, 1924, **38**, 723-34
3. Burk, D., Lineweaver, H., Horner, C. K. and Allison, F. E., *Science*, 1931, **74**, 522-24.
4. Greaves, J. E., Jones, I. and Anderson, A., *Soil Sci.*, 1940, **49**, 9-19.
5. Fred, E. B. and Waksman, S. A., *Laboratory Manual of General Microbiology*, Medium, No. 77, McGraw-Hill Book Co., Inc., London, 1928, pp. 32
6. Waksman, S. A., *Humus*, Williams & Wilkins Co., Baltimore, U.S.A., 1938, pp. 72.

white, are noticed. These are further supported by petrographic studies in the laboratory of nearly 100 microsections.

Large patches of Pakhal xenoliths in the granite mentioned by Mahadevan are merely rocks in which the process of granitization has not been completed. Another important fact that emerged out of these studies is that the foliation direction in the gneisses more or less coincides with the regional strike of the Pakhals. Such remarkable parallelism means two things: either (1) the gneisses have been formed by the granitization of the Pakhals or (2) that any magma that was intruded into the sediments was subjected to the same deforming forces. The indication of a magmatic intrusion is not much in evidence. The granite almost looks like a felspathised Pakhal schist. Even if it is conceded that a granite magma has intruded into the Pakhals, the metamorphism that they have undergone is not thermal metamorphism but regional metamorphism in which both the gneisses and Pakhals suffered similar deformation. This is further supported by petrofabric studies in the laboratory. Petrofabric diagrams prepared in the laboratory for both gneisses and Pakhals suggest that both have undergone same structural deformation suggesting a same tectonic and petrogenetic history for both types. Here again detailed structural studies have thrown some light. The Pakhals of this area have been very much folded into 3 synclines (one of which east of Yellandlapad is an isocline) with connecting anticlines. There appears to be sufficient relationship between metamorphism and depth zones. The presence of uncrystallised banded limestones and slaty phyllites at some places clearly prove that they are in the epizone. Those rocks which were included in the cores of anticlines may be supposed to have suffered greater metamorphism and granitized while in the adjacent synclines they have not passed beyond the phyllite stage. In fact it is by the removal of the anticlinal tops that the granite core has been exposed.

In view of the above field and laboratory evidence, the author agrees with Mahadevan's opinion that the granites of this area are definitely younger than the Pakhals. Whether they resulted from the consolidation of magma or whether they were formed by granitization of the Pakhal rocks is the problem which can be solved only by a detailed field and laboratory investigation which is now under progress.

The author is grateful to Dr. S. Balakrishna, Geology Department, Osmania University, for

suggesting the problem and for his helpful discussion and guidance throughout the work.

Geology Department, Y. JANARDAN RAO.  
Osmania University,  
Hyderabad, Deccan.

June 18, 1958.

1. King, W., *Mem. Geol. Surv. India*, 18, Pt. 3, 13-14.
2. Mahadevan, C., *Presidential Address*, Indian Science Congress, 1949.
3. Heron, A. M., *Journal of Hyderabad Geological Survey*, 5, Pt. 2, 117-24.
4. Read, H. H., *The Granite Controversy*, 1956, 341-42.

### STERILITY IN GRAM

The occurrence of sterility in crop plants is a common phenomena and has been reported by several workers in a large number of crops. In case of gram (*Cicer arctinum* L.), Jagannathrao and Subramanyan,<sup>1</sup> earlier reported sterility where the structure corresponding to the ovary was found to contain minute stamen-like organs and some green bodies. They noted segregation of fertile and sterile plants in individual plant progenies of apparently normal plants but did not study the inheritance. During the course of genetical studies in gram at Kanpur, sterility was noted. This paper deals with its morphology and inheritance.

During the studies of the inheritance of a new mutant named Bunchy<sup>2</sup> sterile plants were noted in 1956-57 in an F<sub>3</sub> progeny of a F<sub>2</sub> bunchy mutant type plant. The F<sub>3</sub> progeny bred true for the mutant type character but segregated into fertile and sterile plants. The sterile plants were like the bunchy mutant in all respects except for their smaller leaflet and flower size and lighter foliage colour and more vigorous growth (Figs. 1 and 2). Unlike the sterile mutant reported by Jagannathrao and



FIG. 1. Fertile. FIG. 2. Sterile.

Subramanyan (1934) where the ovary was replaced by minute stamen-like organs, this

mutant had apparently normal pistillate and staminate parts but it was observed that the anthers did not dehisce properly and less amount of pollen was produced than in the fertile plants. This, however, could not be any cause of sterility as the amount of pollen produced was still enough to give proper seed set. The pollen when studied with acetocarmine stain was found to be quite normal. The meiotic studies also did not reveal any abnormality and the number of chromosomes was found to be  $n = 8$  both in case of sterile and fertile plants. More than two hundred reciprocal crosses were made between the sterile and fertile plants but no pod-setting took place. It is, therefore, concluded that there was complete male and female sterility in this case.

During 1956-57, in the  $F_3$  progeny of the  $F_2$  bunchy mutant type plant there were 75 fertile and 29 sterile plants. This gave a good fit to a 3 fertile : 1 sterile ratio as the chi-square value is not significant (Chi-square 0.461; P. value between 0.50-0.20). Ten apparently normal fertile plants were selected from this population and their individual plant progenies were grown during 1957-58. The results of segregation are given in Table I.

TABLE I

Breeding behaviour of ten progenies of apparently normal plants selected in 1956-57

Progeny	Segregation		Total No. of plants	Chi-square (3:1)	P. value
	Fertile	Sterile			
1	322	102	424	0.201	0.95-0.50
2	116	44	154	1.046	0.50-0.20
3	137	50	187	0.296	0.95-0.50
4	136	49	185	0.217	0.95-0.50
5	178	64	242	0.260	0.95-0.50
6	All	..	183	Breeds true	..
7	150	40	190	1.575	0.50-0.20
8	222	94	316	3.797	0.10-0.05
9	All	..	253	Breeds true	..
10	138	62	200	3.367	0.10-0.05

Of the ten progenies, two bred true for fertility and the remaining eight progenies segregated into fertile and sterile plants and gave a good fit to 3 : 1 ratio (Table I).

These results indicate that sterility in this case is genic and is a simple recessive to the normal fertile condition. As no abnormality in the pollen and the meiotic behaviour of this sterile mutant was observed, embryological studies will now be made. It appears that

sterility is due to some incompatibility phenomena.

Govt. Res. Farm,  
Kanpur, May 8, 1958.

DHARAMPAL SINGH.  
RADHEY SHYAM.

1. Jagannathrao, C. and Subramanyan, P., "A note on the occurrence of sterility in Bengalgram (*C. varietum* L.)," *Madras Agri. J.*, 1934, **22**, 187.
2. Singh, Dharampal and Radhey Shyam, "Genetics of two new mutants in gram, *Cicer arietinum* L.," *Ind. J. Genet. & Pl. Breeding* (unpublished).

**BLIGHT OF SESAME (*SESAMUM ORIENTALE* L.) CAUSED BY *ALTERNARIA SESAMI* (KAWAMURA) N. COMB.**

A SEVERE *Alternaria* blight of Sesame or Til (*Sesamum orientale* L.) resulting in defoliation was observed during November-December 1957 in the State Agricultural Research Station, Bhubaneswar. Further survey of the Sesame crop in the cultivators' fields in the district of Ganjam, Puri, Cuttack and Dhenkanal revealed that the disease was widespread and under moist conditions was responsible for considerable damage.

The disease manifests mainly on the leaf blade as brown, round to irregular spots varying from 1 mm. to 8 mm. in diameter. In early stages of infection, minute brown spots appear on the leaf blade which later become darker in colour with concentric zonations demarcated with brown lines inside the spots on the upper surface (Fig. 1). On the undersurface, the spots are greyish brown in colour. In severe infections, several spots coalesce together involving a major portion of the leaf blade and the affected leaves dry and usually drop off.

The fungus was isolated from the infected leaves and the pathogenicity of the fungus was proved.

The fungus is characterized by simple, erect, more or less flexuose, yellowish brown, 0-3-septate conidiophores, arising singly, measuring  $30-54 \times 4.5-6.5 \mu$  and each bearing conidia singly or in chains at the apex. Conidia are obclavate, yellowish-brown to dark olivaceous brown in colour and measure  $30-120 \times 9-30 \mu$  (excluding the beak), have 4-12 transverse septa and 0-6 longitudinal septa, at which they are slightly constricted and terminate in a long, hyaline beak  $24-210 \times 2-3 \mu$  (Fig. 2).

In morphology the fungus closely resembles *Macrosporium sesami* Kawamura (*Fungi. Nippon Fungological Soc.*, 1, No. 2, p. 27, 1931), but differs from it in having some of the conidia occurring in chains. The authors consider that on account of its catenate conidia, the fungus would more properly be placed in *Alternaria*, and *Alternaria sesami* (Kawamura) n. comb. is therefore proposed.

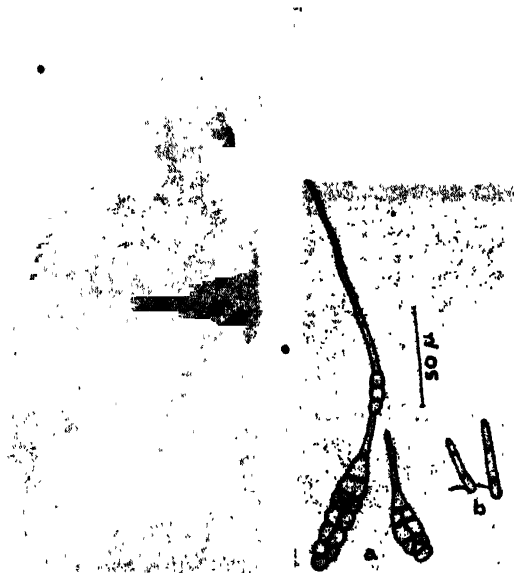

FIG. 1

FIG. 2

FIG. 1. Symptoms of the disease on the leaf.  
FIG. 2. Camera lucida drawing of conidiophores and conidia of *Alternaria sesami*

(a) Conidia.

(b) Conidiophores.

Specimens of the host material with the pathogen have been deposited in the Herbarium of Mycology and Plant Pathology Section, Bhubaneswar, in Herb. Crypt. Ind. Orient. New Delhi (Accession No. 25921) and in Commonwealth Mycological Institute, Kew, England (Herb. I.M.I. No. 71586).

The authors are indebted to the Director and Dr. Ellis of Commonwealth Mycological Institute, England, for having kindly identified the fungus.

Sec. of Mycology & Plant Pathology, N. N. MOHANTY,  
B. C. BEHERA.

Utkal Krushi Mahabidyalaya,  
Bhubaneswar, May 12, 1958.

## STUDIES ON VIRUS DISEASES OF PLANTS IN MADHYA PRADESH

### I. Green Rosette of *Vinca*

ABOUT 90% plants of *Vinca rosea* L. in the garden of our Department, were observed to show certain abnormal features during January 1955. These plants were characterised by extreme shortening of most of the lateral branches and their sub-branches which bore very much reduced leaves. The lamina in the case of these leaves was thin, soft and glabrous with a uniform green colour. These leaves were situated very near together forming tufts with the result that these shoots had a rosetted appearance as seen in the accompanying figure. The flowers produced by these branches were much smaller than those produced by normal plants. Most of them did not open and none formed fruit. There was, however, no discoloration or distortion of any of the floral parts.

Several attempts made to transmit the disease to young healthy plants of *Vinca* by sap inoculation using carborundum powder as an abrasive, gave negative results. The disease was, however, successfully transmitted by wedge grafting to healthy *Vinca* plants raised from seed and kept under insect-proof conditions. After 4-6 weeks from the date of grafting, typical symptoms of the disease developed in the shoots produced by the stocks. Control plants grafted with healthy scions remained free from the disease during the same period.



FIG. 1

As rosette is a well-known disease of groundnut plants attempts were made to transmit the disease of *Vinca* to healthy groundnut plants by grafting, but they were not successful.

Brooks<sup>1</sup> in the Gambia observed *Vinca* plants showing typical symptoms of groundnut rosette. However, according to Hayes<sup>2</sup> there are three distinct types of rosette disease of groundnuts in the Gambia, transmissible by grafting. These are: (1) Chlorosis Rosette, which is by far the most common and is characterised by chlorotic patches on affected leaves. (2) Green Rosette, so called because no chlorosis occurs and the leaves are darker in colour than in a normal plant. (3) Type No. 3 characterised by thickening of the stem and its curving in a clockwise direction. In the absence of any detailed account of the symptoms it is not known which of the above-mentioned three types of symptoms were observed by Brooks on *Vinca*. Again, no attempt appears to have been made to transmit the symptoms to healthy *Vinca* plants to establish the virus nature of the disease nor to transmit the symptoms to healthy groundnut plants to show that the symptoms observed on *Vinca* were due to groundnut rosette.

The symptoms observed on *Vinca* and described herein are obviously different from Chlorosis Rosette and Type No. 3 described by Hayes as there is no chlorosis of leaves or curving of the stem of the affected plants. They, however, resemble the green rosette of groundnuts to some extent as there is no chlorosis of the leaves which are very much reduced and are in tufts, but they differ from green rosette symptoms on groundnuts in some important respects because in *Vinca* there is no red colouration of the calyx and no thickening of the stem. Again, the disease could not be transmitted by grafting from *Vinca* to healthy groundnut plants. It appears therefore that the disease of *Vinca* under report is distinct from groundnut rosette.

I am grateful to Shri D. W. Kshirsagar, Head of Botany Department, for providing facilities and to Shri S. N. Mishra, then a student of mine, for taking the photograph used here.

Dept. of Botany, R. P. GARGA.  
Holkar College, Indore (M.P.),  
May 20, 1958.

1. Brooks, A. J., *Ann. Rep. Dept. Agric. Gambia*, 1932, 9-11.

2. Hayes, T. R., *Trop. Agric. Trin.*, 1932, 9, 211-17.

### THREE NEW BACTERIAL DISEASES OF PLANTS FROM BOMBAY STATE

#### 1. SEEDLING BLIGHT OF ONION\*

A NEW bacterial disease causing severe tip blight of onion seedlings in Nasik and Broach Districts received in 1953 showed it to be dif-

ferent from the blight, bulb rots and streak so far described. In severe cases, the symptoms extended up to ground level, killing the plants. The technical description of the pathogen herein named *Phytobacterium siccatum* sp. nov. is given below:

Short rods, mostly single, rarely in pairs,  $1.6 \times 0.9 \mu$ ; 1-2 polar flagella; gram negative; capsulated; non-spore-former; not acid-fast; colonies on potato dextrose agar plates are circular with entire margin, shining, butyrous, pearly white, measuring 7 mm. in 8 days; similar but heavier growth on yeast-glucose-chalk agar; copious, pale olive Buff (R) growth on potato cylinders; gelatine and starch not attacked; plain milk neither digested nor peptonised; litmus milk turned alkaline;  $\text{NH}_3$  and  $\text{H}_2\text{S}$  from peptone;  $\text{NO}_3$  reduced to  $\text{NO}_2$ ; no indol; M.R. and V.P. tests negative; no green fluorescence; in a peptone-free medium, acid without gas from dextrose, lactose, xylose, sucrose, mannitol, glycerol, levulose, dulcitol and salicin; optimum temperature for growth  $27-31^\circ \text{C}$ .; thermal death-point  $61^\circ \text{C}$ .

Pathogenic to *Allium sativum* L. and *A. cepa* L. Found at Broach and Nasik.

#### 2. LEAF-SPOT OF *Martynia diandra* GLOX.

The symptoms of a new bacterial disease on *Martynia diandra* received from Nasik and East Khandesh Districts were manifested as minute, water-soaked, translucent, round to angular leaf-spots measuring 1-3 mm. Under severe infection, the spots coalesce forming streaks along the veins. Leaves appear to be more susceptible and drop down with the slightest touch when heavily infected. The pathogen herein named *Xanthomonas martinicola* sp. nov. differs from *Bacterium martyniae* Elliott in many respects. Its technical description is as follows:

Short rods with rounded ends, single but rarely in pairs, measuring  $1.3 \times 0.6 \mu$ ; gram negative; capsulated; non-spore-forming; not acid-fast; motile by polar flagellum; colonies on potato dextrose agar plates circular with entire margin, smooth, glistening, butyrous, 6-12 mm. in 8 days, Baryta yellow (R); growth on potato cylinders copious, flowing. Barium yellow (R); gelatine and starch attacked; casein digested; milk peptonised with curdling; litmus reduced;  $\text{NH}_3$  and  $\text{H}_2\text{S}$  from peptone;  $\text{NO}_3$  not reduced; no indole; M.R. and V.P. tests negative. In a peptone-free medium, acid without gas from glucose, lactose, xylose, sucrose, mannitol, levulose and glycerol; no growth in salicin; aerobic; thermal death-point about

52° C. Optimum temperature for growth 27-30° C.

Pathogenic to *Martynia diandra*. Found in Nasik and East Khandesh Districts.

3. LEAF-SPOT OF *Vitis carnosae* WALL.

A new bacterium inciting spots on leaves of *Vitis carnosae* received from Jalgaon differs from others pathogenic to *Vitis* spp. The spots are 1-3 mm., rough to touch, dark in colour and surrounded by halo with raised centre due to bacterial exudate. The technical description of the pathogen herein named *Xanthomonas vitis-carnosae* sp. nov. is given below:

Short rods with rounded ends, single but rarely in pairs, measuring  $1.6 \times 0.8 \mu$ ; gram negative; capsulated; non-spore-forming; not acid-fast; motile by a polar flagellum; colonies on potato dextrose agar plates circular with entire margin, smooth, glistening, butyrous, 5-10 mm. in 8 days, Barium yellow (R); growth on potato cylinders copious, flowing, Baryta yellow (R); gelatine and starch attacked; casein digested; milk peptonised with clearing at the top; litmus reduced;  $\text{NH}_3$  and  $\text{H}_2\text{S}$  from peptone;  $\text{NO}_2$  not reduced; no indole; M.R. and V.P. tests negative. In a peptone-free medium, acid without gas from glucose, lactose, xylose, sucrose, mannitol, levulose, galactose and glycerol; no growth in salicin; aerobic; thermal death-point about 51° C.; optimum temperature for growth 27-30° C.

Pathogenic to *Vitis carnosae* but not to *V. vinifera*. Found at Jalgaon.

The detailed account will be published elsewhere.

Plant Pathological Lab.,  
College of Agriculture,  
Poona, May 27, 1958.

L. MONIZ.  
M. K. PATEL.

**SELECTION OF MURRAH BUFFALOES FOR MILK YIELD ON THE BASIS OF UDDER CONFORMATION**

FARMERS in India usually select buffaloes for milk yield on the basis of udder conformation. This phenomenon has never been put to any scientific test. We are, however, for the first time reporting here an experiment which gives evidence of the utility of udder conformation for selecting buffaloes for higher milk yield.

Twenty Murrah buffaloes constituted the experimental material, seven in first lactation, eleven in second lactation and two in third lactation. The health of these animals in general was very good. Milk yield of each animal was recorded under supervision.

The animals were scored before the evening milking. The udder score was made by visualizing distention of the udder. Animal with highly distended udder and with prominent milk vein was scored high for udder conformation and least for shrunken udder and with less prominent milk vein. Since the variation amongst animals for udder size did not appear to be very large, only three scores 2, 1, and 0 were given in the descending order of their merits. Each animal was scored thrice by two observers. While scoring each time the observers made no reference to the score given last time. The score used for the final assessment of analysis is the sum of scores of the three readings of both the observers.

TABLE I  
Analysis of variance

Source of variation	df	S.S.	M.S.
Between observations	2	0.050	0.025
Between observers	1	0.008	0.008
Between animals	19	52.091	2.742*
Between observers × observations	2	0.417	0.209
Between observers × animals	19	4.442	0.234
Between observations × animals	38	7.284	0.165
Between observers × observations × animals	38	6.633	0.174

\* Significant at 1% level.

Table I indicates significant differences between animals. These significant differences are of great advantage since selection for milk yield on the basis of udder conformation can be practised. However, the level of scoring was maintained uniformly since no difference between observers could be observed and their repeatability was 0.73 which is highly significant.

TABLE II  
Phenotypic correlation coefficients

Relations	Correlation coefficients
Between udder score × milk produced after score	+ 0.872*
Between udder score × milk produced at the peak of the lactation	+ 0.517*
Between udder score × total yield for entire lactation	+ 0.328

\* Significant at 1% level.

Data on milk yield were corrected for stage of lactation. Udder score was correlated with (i) milk produced after scoring, (ii) milk yield at the peak of lactation (4th and 5th months), and (iii) total milk yield for the entire lactation.

Results presented in Table II indicate that udder conformation 'gives an accurate prediction of the animal's milk yield for that time and relatively less information about the peak of lactation but it gives no information about the animal's milk production during the entire lactation.

Thanks are due to Dr. R. L. Kaushal, Principal, and Joint Director of Research, for his advice and encouragement during the course of this investigation.

College of Veterinary Science and Animal Husbandry-cum-Livestock Research Institute, Mhow, M.P., June 25, 1958.

G. C. TANEJA.  
D. S. BHATNAGER.

#### AN ADDITION TO INDIAN ASPERGILLI

MOHANTY (1948) published an account of Indian *Aspergillus* in which he dealt with twenty-four species. Later on, Chattopadhyay and Dasgupta (1953) added three more species. More recently Saksena and Shetye (1956) have published an account of three other species of *Aspergillus*. This paper adds one more species of *Aspergillus* to the list of Indian *Aspergilli* already known.

During the course of investigation of soil fungi of grasslands of Banaras, the author has found thirteen species of *Aspergillus*, out of which *A. lutescens* Bainier has been recorded for the first time from India.

The fungus was isolated from soil collected at a depth of 4" from stands of *Dichanthium annulatum* Staf. association having *Cyperus* sp. and herbs like *Croton sparciflorus* Morung., *Corchorus acutangularis* Lamk., *Cassia tora* Linn., *Euphorbia hirta* Linn., *Vernonia cineria* Less., *Crotalaria medicagenia* Lamk., *Digera arvensis* Forsk., *Tephrosia purpurea* Pres., *Amaranthus viridis* Linn. and others. The pH, moisture content and temperature of soil at this depth were 7.2, 15.6% and 88° F. respectively.

Colonies on Czapek's agar rapidly growing and broadly spreading, floccose, margin at first white becoming rusty yellow with conidial formation, finally becoming chestnut brown (Maerz and Paul, 1930; plate 7 E, 10) when conidial areas mature. Reverse of colonies pale yellow. Conidial heads radiate, hemispherical to subglobose, Buckthorn brown (Maerz and Paul, 1930; plate 13 L, 8) to Dresden Brown (Maerz and Paul, 1930; plate 14 K, 8), comparatively small 70-90  $\mu$  in diameter when young; conidiophores 9-12  $\mu$  in diameter; varying greatly in length, mostly short, arising

from substratum or as aerial branches from hyphae, walls pale yellowish with pitting, sometimes pitting not clear. Vesicles globose to

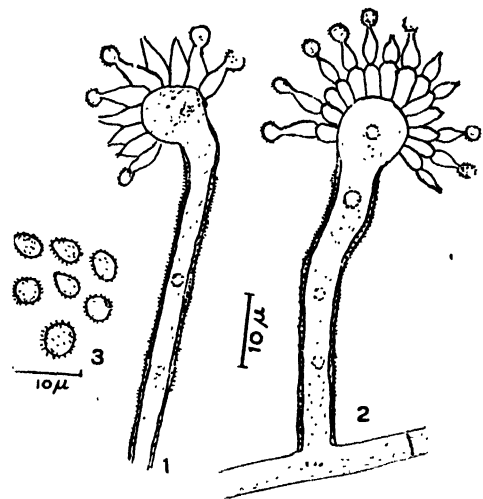

FIGS. 1-3. *Aspergillus lutescens* Bainier. Figs. 1-2. Conidial heads with single and double series of sterigmata respectively. Fig. 3. Conidia.

sub-globose, 18-30  $\mu$  in diameter. Sterigmata in one series on smaller heads, upto 14.5-25.0  $\mu$  by 4.5-5.4  $\mu$ . Sterigmata often in two series on larger heads, primary nearly 14.4-18.0  $\mu$  by 4.5-5.4  $\mu$ , secondary 9-12  $\mu$  by 4.5-5.0  $\mu$ . Conidia globose, from 5.4-9.0  $\mu$  in diameter if globose, 8.0  $\times$  7.2  $\mu$ -9.0  $\times$  7.2  $\mu$ , if sub-globose, roughened with tubercles of colour.

The culture of this species is being deposited in the Indian type culture collections of fungi, Indian Agricultural Research Institute, New Delhi, India.

I have great pleasure in expressing my indebtedness to Dr. R. Y. Roy for guidance, and to Prof. R. Misra for facilities.

RAMA SHANKAR DWIVEDI.

Dept. of Botany,  
Banaras Hindu University,  
Varanasi-5, June 27, 1958.

1. Chattopadhyay, S. B. and Dasgupta, C., *Indian Phytopathology*, 1953, **6**, 92-95.
2. Maerz, A. and Paul, M. R., *Dictionary of Colour*. McGraw-Hill Book Co., N.Y., 1930.
3. Mohanty, U., *Indian Phytopathology*, 1948, **1**, 55-65.
4. Saksena, S. B. and Shetye, P. K., *Ibid.*, 1956, **9**, 138-44.
5. Thom, C. and Raper, K. B., *A Manual of the Aspergilli*, The Williams & Wilkins Co., Baltimore, Md., 1945, 373.

### A CASE OF CHROMOSOMAL INTER-CHANGE IN PEARL MILLET

KRISHNASWAMY AND RANGASWAMY AYYANGAR (1941)<sup>1</sup> reported chromosomal alterations in three plants of *Pennisetum typhoides* in a population raised from X-rayed seeds. In about 28% of the cells examined by them rings or chains of four chromosomes and in one plant larger rings of six chromosomes were observed. In addition a case of inversion was inferred. In the ring-forming cells unequal distribution of chromosomes was noted by them at anaphase I, and sometimes the movement of the entire ring to one pole was reported. The plants were semi-sterile.

In plants raised from seeds of *Pennisetum* species got from different countries for the study of morphology of pachytene chromosomes, a structural hybrid of Pearl Millet, *Pennisetum typhoides* called *P. glaucum* in America, showing reciprocal translocation was encountered by the writer. The plants showing the chromosomal interchange are commercial hybrids evolved by Dr. Glenn W. Burton at Tifton Georgia, and named as "Gahi 1".

Figs. 1 and 2 represent the cross-shaped configurations at pachytene stage. If a segmental interchange has occurred, one would expect during early meiotic prophase in plants heterozygous for this interchange a cross-shaped synapctic complex made up of two normal and two interchanged chromosomes (McClintock, 1930).<sup>2</sup> Of the chromosomes involved one seems to be that with median centromere and of medium size and the other to be with a sub-median centromere. An analysis of pachytene chromosomes in related materials AKP 3 and AKP 2 (*P. typhoides* local) has shown that the 7 haploid chromosomes can be distinguished on the basis of the total length of the chromosome and the position of the centromeres. On this basis the 7 pairs of pachytene chromosomes could be classed into (i) 2 pairs which are longest in the complement with median centromeres, (ii) 2 pairs with median to sub-median centromeres and smaller than the first 2 pairs of chromosomes, (iii) 2 pairs with sub-median centromeres and of medium size, and (iv) lastly one pair of nucleolar organisers. One of the chromosomes belonging to the second group and one belonging to the third group seem to be involved in segmental interchange here reported.

At diakinesis in 150 cells examined at random 75 cells showed a ring of four chromosomes plus five bivalents and 29 cells showed a chain of four plus five bivalents. The chiasma frequency in cells having rings or chains and those with-

out rings or chains showed no variation. Of the two types of orientation of the ring at meta-



FIGS. 1-3. Microphotographs. Figs. 1 and 2. Pachytene stages showing the cross-shaped configuration. Fig. 3. Metaphase I showing the open ring.  $\times 2,400$ .



phase I (McClintock, 1932<sup>3</sup>; Garber, 1955<sup>4</sup>; Burnham, 1956<sup>5</sup>) only the open ring could be seen in a large number of cells (Fig. 3). The zig-zag orientation of the ring could not be located even after a careful examination of a large number of cells. The open ring at metaphase I results in the adjacent segregation at anaphase I and consequently leads to sterility. On this basis the pollen sterility should correspond to the percentage of cells showing ring of four chromosomes. Fifty per cent. of cells examined showed rings of four. The pollen analysis revealed only 40% of sterile pollen, this shows that in about 10% of cells with rings alternate type of disjunction at anaphase I may be expected. Thus on theoretical grounds, 10% of ring-forming cells may have zig-zag orientation at metaphase I.

I wish to express my sincere thanks to Prof. J. Venkateswarlu for helpful suggestions, and to Dr. Glenn W. Burton, Principal Geneticist, Georgia Experimental Station, U.S.A., for the kind supply of seed.

This work was carried out during the tenure of Government of India Research Scholarship.

Dept. of Botany,  
Andhra University,  
Waltair, June 30, 1958.

J. V. PANTULU.

1. Krishnaswamy, N. & Rangaswamy Ayyangar, G. N., *Indian Bot. Soc.*, 1941 **20**, 111-17.
2. McClintock, Barbara *Proc. Nat. Acad. Sci.*, 1930, **116**, 791-96
3. —, *Zeits. Zellf. u. mikr. Anat.*, 1933 **19**, 191-237.
4. Garber, E. D., *Bot. Gaz.* 1955, **116**, 369-72.
5. Burnham, C. R., *Bot. Kär.* 1956, **22** (7), 419-552.

#### INTERSPECIFIC HYBRIDIZATION BETWEEN *MUCUNA PRURIENS* DC. AND *MUCUNA COCHINCHINENSIS* A. CHEV.

*Mucuna* Adan. a tropical genus of vigorous leguminous woody climbers, belongs to family Papilionaceae. Index Kewensis mentions about 30 species in this genus, while Cooke (1903) describes only 4 species as occurring in Bombay State. *M. pruriens* is a hardy twiner, commonly found growing wild in this part of India. Its leaves form an excellent cattle fodder till the plants come into flower. The stiff hair on the pod and the calyx cause considerable irritation when they penetrate human skin. Its seed has considerable use as medicine (Watt, 1891). *Mucuna cochinchinensis* A. Chev. (Syn. *M. nevia* DC.) is a cultivated annual. The plant forms a valuable leguminous fodder all

throughout the tropics and its seeds are used as vegetable. This plant is also used for green manure. It appears to be one of the excellent species of the genus from the point of view of food and fodder (Burkill, 1935). According to him, hybridization between the cultivated species of *Mucuna* is possible.

*M. pruriens* has flowers with dark purple petals and calyx and short pods with bristles, whereas *M. cochinchinensis* has flowers with pale purple petals and calyx. Its pods are long smooth and without any bristles. Crosses were made between these plants in order to introduce hardness of the wild parent, i.e., *M. pruriens*, in the cultivated parent, *M. cochinchinensis*. Reciprocal crosses were also secured. Both the F<sub>1</sub> hybrids were intermediate between the two parents in petal and calyx colour, pod size and the bristles on the pod. The seeds of *M. pruriens* are brown whereas in *M. cochinchinensis* they are white. In both the F<sub>1</sub>s they are of brown colour indicating the dominance of brown colour. The seeds are intermediate in the size when compared with the parents.



FIGS. 1-4. Flowers, pods, seeds and chromosome at Metaphase I ( $n = 11$ ),  $\times 1,500$  in (1) *Mucuna pruriens*, (2) *Mucuna cochinchinensis*, (3) F<sub>1</sub> *M. pruriens* × *M. cochinchinensis* and (4) F<sub>1</sub> *M. cochinchinensis* × *M. pruriens*.

Flower-buds from the parents and the two F<sub>1</sub>s were fixed in acetic alcohol 3 : 1 and stained with propionocarmine. The chromosome

number of *M. pruriens* is  $2n = 22$ , which agrees with the one determined by Fram Leliveld as reported by Darlington and Wylie (1955). The chromosome number in *M. cochinchinensis* is also  $2n = 22$ . Meiosis in the parents is normal and Figs. 1-4 show the chromosomes at Metaphase I in parents and the hybrids as well as some of the morphological characters. Study of inheritance of morphological characters is in progress.

My grateful thanks are due to Dr. M. C. Desai, Economic Botanist, Department of Agriculture, Bombay State, Poona, for the help and guidance in these investigations. I am thankful to Shri A. S. Jadhav for the photographs.

Cytological Lab., M. V. THOMBRE.  
Botany Section,  
College of Agriculture,  
Poona-5, July 1, 1958.

1. Burkill, I. H., *A Dictionary of Economic Products of the Malay Peninsula*, Crown Agents for the Colonies, London, 1935, 1498-1503.
2. Cooke Theodore, *The Flora of the Presidency of Bombay*, Taylor and Francis, London, 1903, 1, 365.
3. Darlington, C. D. and Wylie, A. P., *Chromosome Atlas of Flowering Plants*, George Allen & Unwin Ltd., 1955, 171.
4. Watt George, *Dictionary of Economic Products of India*, 1891, 5, 786.

### ERGOT OF BAJRI (*PENNISETUM TYPHOIDES*) IN BOMBAY STATE

In an earlier note<sup>1</sup> the ergot of bajri [*Pennisetum typhoides* (Burm.) Stapf and Hubbard] was recorded in South Saṅara District of Bombay State and its pathogenicity to bajri was proved by inoculation with *Sphaelial* stage (Fig. 1). The present note deals with the physiology of the pathogen and its identity.

In artificial culture the fungus is very fastidious in its nutrition, requiring 6% cane sugar and 0.5% proteose peptone. It grows well only on a few culture media such as Kirchoff's original and modified medium (solid as well as liquid), Sabouraud's medium, modified Czapek's medium and on steamed flowering heads of bajri. It does not elaborate many enzymes and is incapable of utilising amino acids singly as source of carbon and nitrogen. Conidia, produced on a few media only such as Kirchoff's, germinate readily at 25-27° C. The thermal death-point of the mycelium and of conidia lies around 55° C.

The mature sclerotia contain 0.42% w/w of the total alkaloids of ergot calculated as ergotoxin,

The fungus is pathogenic to bajri only and did not infect any of the other species of *Penni-*



FIG. 1. *Sphaelial* stage.

*setum* tested. All available varieties and strains of bajri from Bombay State proved highly susceptible to ergot infection and hence

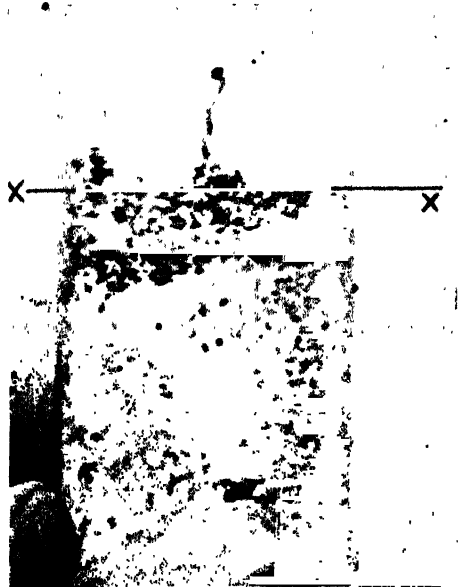

FIG. 2. Germinating sclerotium, × nat. size.

scope for breeding resistant varieties seems uncertain.

A few sclerotia germinated after 35 days when kept in a mixture of sterile sand and soil as recommended by Thirumalachar<sup>2</sup> (Fig. 2) and each produced one to three stipes. Asci were produced in the mature stromata and their measurements agreed closely with those of the asci of *Claviceps microcephala* (Wallr.) Tul., the pathogen causing ergot of *Pennisetum hohenseckeri* Hochst described by Thomas *et al.*<sup>3</sup> and by Thirumalachar.<sup>2</sup> The morphology and measurements of conidia, their mode of germination, the colour of stromata and germination of sclerotia of the bajri ergot fungus are also similar to those of *Claviceps microcephala* (Wallr.) Tul. It is, therefore, proposed to refer the bajri ergot fungus to *Claviceps microcephala* (Wallr.) Tul.

Plant Pathological Lab.,  
College of Agriculture,  
Poona, July 9, 1958.

P. A. SHINDE.  
V. P. BHIDE.

1. Bhide, V. P. and Hegde, R. K., *Curr. Sci.*, 1957, **26** (4), 116.
2. Thirumalachar, M. J., *Nature*, 1945, **156** (3973), 754.
3. Thomas *et al.*, *Proc. Ind. Acad. Sci.*, 1945, **21B** (2), 94.

#### ASEXUAL REPRODUCTION IN *CHARACIOSIPHON RIVULARIS* IYENGAR

THE alga *Characiosiphon* first established by Prof. Iyengar<sup>3</sup> in 1936, and subsequently reported from few other places in India<sup>1,2,4</sup> was recently collected by the author at Indore (M.P.) in abundance during the months of September and October 1957, from a city drain. The alga appeared to grow on any object which it could catch hold of. The size of the thalli was recorded upto 1.1 cm. in length. Some young thalli were particularly interesting in showing lobed condition but the author, however, could not get any indication of lobing in fully grown thalli in his material as reported by Agarkar.<sup>1</sup>

The material was microtomed, for a detailed study and the observations confirmed the results of Prof. Iyengar.<sup>3</sup> The alga was also cultured in the laboratory in water obtained from the drain with a little Knops solution added to it, in which it survived for more than a week or so. Zoospores and gametes were easily obtained, as the alga, kept even in rain-water, produced these swimmers the next day at about 10 to 12 o'clock in the laboratory.

Nothing strikingly different from what Prof. Iyengar<sup>3</sup> has recorded was observed except a peculiar phenomenon of asexual reproduction by cyst formation which is described below. These cysts, however, were also observed in the material collected from natural habitat.

Some of the old thalli, showing signs of degeneration, transformed a major part of their protoplast into numerous spherical bodies (Figs. 1, 3) which varied from 67 to 169  $\mu$  in diameter. These consisted of several discrete

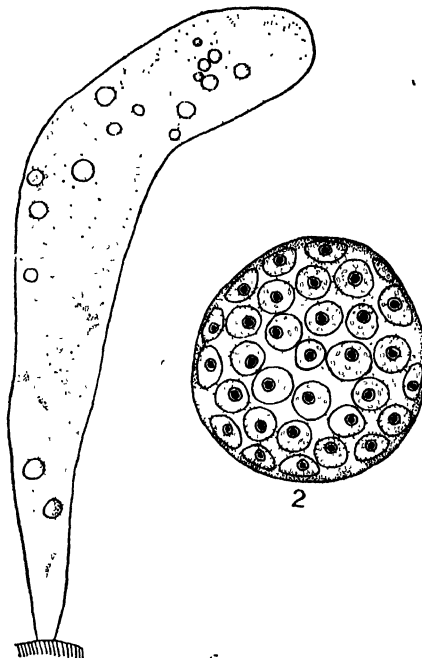

FIGS. 1 and 2. *Characiosiphon rivularis* Iyengar. Fig. 1. Entire thallus showing disintegrating protoplast and rounded protocenocysts,  $\times 15$ . Fig. 2. Single protocenocyst,  $\times 150$ .

uninucleate protoplasts surrounded by a newly secreted wall forming a spherical "protocenocyte" (Fig. 2). These were freed from the thallus by the gelatinization of the parent wall and the protocenocytic bodies, after liberation, attached themselves to the slides kept in the culture dishes; probably by secreting some adhesive substance and started germination immediately without any resting period. The subsequent germination and growth stages of these bodies were exactly like those of the zoospores except that the growth in this case started initially as a protocenocyte and not as a single cell.

Formation of cenocyst is known in the genus *Protosiphon*,<sup>4</sup> where the protoplast breaks up into numerous multinucleate masses and each

gets surrounded by a new wall. *Characiosiphon rivularis* exhibits a similar mode of cyst formation with the modification that here the cyst is formed as a protocœnocyte from the very beginning. Therefore, it is suggested that the



FIG. 3. Photomicrograph of *Characiosiphon rivularis* Iyengar, showing a part of the thallus with rounded protocœnocytes,  $\times 38$ .

cyst, in case of *Characiosiphon*, may be designated as a 'protocœnocyte'. However, it would be unsafe to draw any affinity between *Characiosiphon* and *Protosiphon* only on the basis of similarity in cyst formation, as the two algae differ markedly from each other in various other important characters.

The author is thankful to Dr. W. V. Bhagwat, Principal, and Prof. D. W. Kshirsagar, Head of the Department, for facilities and encouragement. Grateful thanks are also due to Prof. M. O. P. Iyengar for going through the manuscript and for his valuable suggestions.

Dept. of Botany,  
Holkar College, Indore,  
July 19, 1958.

RAMJI SHARMA.

1. Agarkar, M. S., *Curr. Sci.*, 1953, **22**, 245.
2. Bhandari M. M., *Ibid.*, 1955, **24**, (1).
3. Iyengar, M. O. P., *Jour. Indian Bot. Soc.*, 1936, **15**.
4. —, *Manual of Phycology*. Chronica Botanica Publication, 1951, 43.
5. —, *Jour. Indian Bot. Soc.*, 1954, **33**.
6. Rao, K. V. S., *Curr. Sci.*, 1954, **23**, 191.

### MORPHOLOGY OF THE OVULE OF *ZEPHYRANTHES CITRINA* BAKER

OF the 60 species of *Zephyranthes*<sup>1</sup> only three have been investigated,<sup>2, 5</sup> and in no case is there much information on the development of the embryo. According to Pace<sup>2</sup> the division of the primary endosperm nucleus of *Z. texana*, an apomictic species, is followed by a wall which soon disappears. In *Z. andersonii* the endosperm is Helobial; the thin membrane separating the chalazal and the micropylar chambers was clear in early stages while it could not be seen subsequently.<sup>3</sup> Mendoza<sup>4</sup> states that in *Z. rosea* the synergids are devoid

of a filiform apparatus and that the antipodal nuclei do not organize into cells although Steinar<sup>5</sup> had earlier described the synergids with an apical filiform apparatus and the antipodals as fairly large cells. The present study deals with the megasporogenesis, endosperm and embryo of *Z. citrina*, a perennial bulbous plant cultivated in gardens.

The numerous anatropous ovules are borne in pairs on axile placentæ in the trilocular inferior ovary. There is a single hypodermal archesporial cell (Fig. 1) which directly functions as the megaspore mother-cell forming two dyad cells (Fig. 2). The upper of the two dyad cells soon disintegrates (Fig. 3) and only the lower undergoes the second meiotic division resulting in two megaspores (Fig. 4) of which the chalazal is functional. Three free nuclear divisions follow resulting in an 8-nucleate embryo-sac of the Polygonum type. The two polar nuclei begin to fuse about the time the second male nucleus reaches them in the chalazal region. The synergids are hooked but no large vacuoles are seen in them. A filiform apparatus is present in the apical part while the nucleus is placed basally. The antipodal cells persist in a hypertrophied condition during the post-fertilisation stages for a considerable time. The micropyle is formed by the inner integument only. Fertilisation takes place approximately five hours after pollination. A point of interest is the presence of a clear space around the male nucleus that fuses with the egg while such a space is not seen around the second male nucleus that fuses with the two polar nuclei to form the primary endosperm nucleus (Fig. 5).

The endosperm is of the Helobial type. The primary endosperm nucleus divides earlier than the fertilised egg and results in the formation of a smaller chalazal and a much larger micropylar chamber (Fig. 6). Free nuclear divisions take place in both the chambers but the divisions are much more numerous in the micropylar chamber. Ultimately there are about 16 nuclei in the chalazal chamber. During early stages the nuclei in the micropylar chamber are distributed in the peripheral cytoplasm. At places some of the nuclei seem to divide much more rapidly in the micropylar chamber and the daughter-nuclei so formed fuse and divide again resulting in polyploid nuclei (Fig. 7). Later, cell-wall formation takes place in micropylar chamber while the antipodal cells and the coenocytic chalazal chamber disintegrate. In the final stages some of the endosperm cells contain

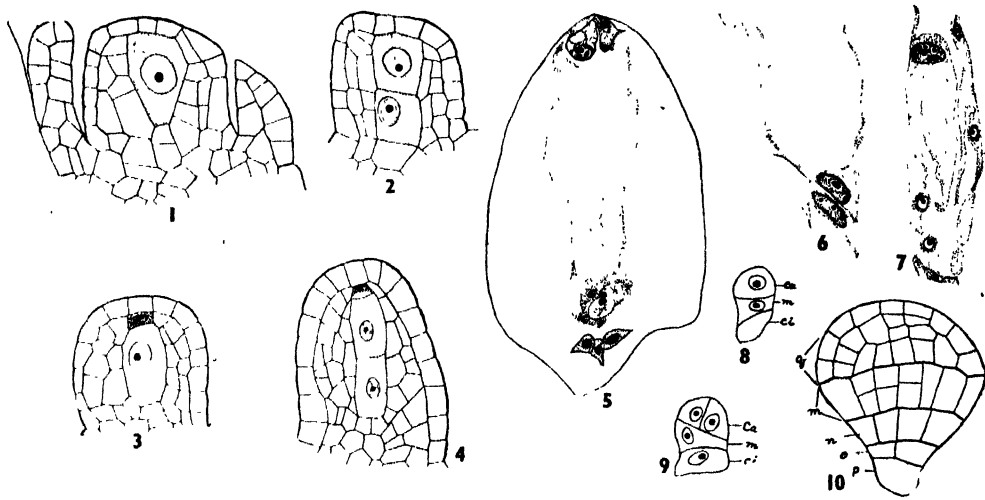

FIGS. 1-10

FIG. 1. I. s. ovule showing the archesporial cell,  $\times 250$ . Fig. 2. L. s. nucellus showing the dyad cells  $\times 250$ . Fig. 3. Same showing the disintegration of the upper dyad cell,  $\times 250$ . Fig. 4. Same showing the two megaspores formed from the lower dyad cell,  $\times 250$ . Fig. 5. Embryo-sac showing syugamy and triple fusion (drawn from three sections),  $\times 60$ . Fig. 6. Endosperm showing the micropylar and chalazal chambers with one nucleus in each,  $\times 160$ . Fig. 7. Micropylar chamber of the endosperm showing triploid nuclei and polyploid nucleus,  $\times 160$ . Figs. 8-10. Stages in the development of embryo,  $\times 160$ .

polyploid nuclei while others contain triploid nuclei.

The embryo conforms to the Asterad type of Johansen<sup>6</sup> (Figs. 8, 9, 10). The vascular strand that supplies the ovule can be traced into the base of the outer integument on the side opposite to the funicle.

Grateful thanks are due to Professor P. Maheshwari for scrutinising some of the preparations and for valuable suggestions. Thanks are also due to the Director, Royal Botanic Gardens, Kew, for identifying the plant and to the Ministry of Education and Scientific Research, Government of India, for a grant-in-aid.

Dept. of Biology.

B. S. M. DUTT.

Gudivada College,

Gudivada, July 5, 1958.

### INDIAN HOUSE SPARROW AS AN ENEMY OF THE DESERT LOCUST

HUSAIN AND BHALLA (1931) stated that the Indian house sparrow, *Passer domesticus*, had not been seen preying upon the adults of the desert locust, *Schistocerca gregaria* (Forsk.), in Ambala District (Punjab), nor had the locust been found in the stomach of this bird. The observations made by the author in Bikaner District from 1954 to 1956 have, on the other hand, shown that this bird actively preys upon both adults and hoppers of the desert locust. During the monsoon months, groups of sparrows may be seen roosting on the bushes in the desert area where large number of desert locust adults may also be met with. The sparrows generally catch locusts at the pronotum with their beaks and then strike them on the ground till they are killed before devouring. Sometimes they catch them in their claws and put them in their beaks and kill. Wings are not eaten.

The sparrows may often be seen in flocks specially during post-monsoon and early winter season. Their zigzag flights near the ground must disturb the locust adults which are probably devoured while they fly about.

The sparrow was seen preying largely on the early stage hoppers and feeding its young ones

1. Willis, J. C., *A Dictionary of the Flowering Plants and Ferns*. Sixth Edition, Cambridge, 1951.
2. Pace, L., *Bot. Gas.*, 1913, **56**, 376-94.
3. Swamy, B. G. L., *Proc. Natl. Inst. Sci. India*, 1946, **12**, 187-90.
4. Merdoza, D. R., *Phillip. Jour. Sci.*, 1954, **83**, 219-38.
5. Stenar, H., *Embryologische Studien I' and II. I. Zur Embryologie der Columiferen. II. Die Embryologie der Amaryllideen. Diss., Uppsala*, 1925.
6. Johansen, D. A., *Plant Embryology*, Chronica Botanica, 1950.

on them while other enemy birds of the desert locust prefer to feed on advanced stage hoppers.

It was also observed preying upon the escapes of adults from the field cages during rearing in 1954, 1955 and 1957 at Bikaner.

Locust Warning Officer, CHARAN SINGH.  
Churu (Rajasthan),  
July 21, 1958.

1. Husain, M. A. and Bhalla, H. R., Some bird enemies of the desert locust (*Schistocerca gregaria* Forsk.) in the Ambala District (Punjab), *Indian J. Agri. Sci.*, 1931, 1, Part 5, 609-19.

### PRELIMINARY OBSERVATIONS ON THE SYSTEMIC ACTION OF THREE ORGANIC PHOSPHATES ON THE RED COTTON BUG [*DYSDERGUS CINGULATUS* (FABR.), HEMIPTERA: PYRRHOCORIDAE]

INTRODUCTION of chemical substances into the sap of plants by vascular injection has been commonly practised in the past for controlling pests and diseases. But in recent years, many workers have claimed successful control of some insect pests with systemic insecticides. Systemic insecticides are classified as those chemicals which are absorbed and translocated through roots or leaves to other parts of the plants, exerting toxic effect on the insects feeding on them.

The studies on the systemic action of the organic phosphates (*Systox*, *Pestox* and *Diazinon*) were carried out against the "Red cotton bug". To initiate this investigation, the *Bhindi* plants were potted in earthen pots. When the plants were fifteen days old, the trial was undertaken. The solutions of each chemical at three levels of concentration (0.05%, 0.025% and 0.0125%) were added to the soil as irrigation water. Soon after the treatment, each treated pot was covered with a layer of dry soil for providing a compact uniform coating against evaporation of chemical-fumes. After an interval of twenty-four hours, the treated earthen pots with plants were put inside wire cages. Ten adult bugs were confined in each cage for studying the systemic reaction of the chemicals. Each treatment including control was replicated thrice. Records of mortality of bugs under different treatments were maintained for eight days.

The percentage of mortality of the adult bugs under the treatments of *Systox*, *Pestox* and *Diazinon* were 52.2, 36.7 and 21.1 respectively at 0.05% concentration as against 13.3, 13.3

and 3.3 mortality at 0.0125% concentration. *Systox* and *Pestox* treatment gave identical response at 0.0125% concentration. The maximum kill of the "Red cotton bugs" under different treatments were recorded on the third day of the experiment. None of the organic phosphates included in the trial seems to exhibit any phytotoxic reaction on the plants. Curiously enough, an increased fruiting was observed on treated plants as compared to those which were untreated ones.

The findings of this paper confirm the observation of Ivy and his associates (1950) that *Systox* has more pronounced systemic action than other organic phosphates tried against the cotton pests. Banerjee and Basu (1955) reported that *Tetrax* (an organic phosphate compound) when absorbed and translocated through the roots of the plants was found to render the plants toxic to the "Red cotton bug". The increased fruiting as observed on the treated *Bhindi* plants indicated that the organic phosphate used in the experiment might have been converted into available phosphates and they were in turn utilized by the plant for increased yield. This may also account for a rapid decomposition of the toxicities of the organic phosphate compounds. Such reaction in plants are clearly demonstrated by Fukuto and his associates (1955). The chemical *Pestox* seems to have a definite systemic reaction. However, it needs further confirmation.

The authors wish to express their gratitude to Dr. R. H. Richharia, Principal, for providing necessary facilities in the Post-Graduate Laboratory for carrying out the investigation.

Division of Entomology, B. S. LALL.  
Bihar Agric. College, M. TIWARY.  
Sabour, July 21, 1958.

1. Banerjee, S. N. and Basu, A. C., *Sci. and Cult.*, 1956, 20, 599-600.
2. Fukuto, T. R. and his associates, *Jour. Econ. Ent.*, 1955, 48 (4), 347-54.
3. Ivy, E. F. and his associates, *Ibid.*, 1950, 43 (5), 620-26.

### A NEW CUTWORM PEST OF POTATO IN RAJASTHAN

THE cutworms, *Agrotis interacta* Wlk., were unusually abundant in the potato fields in Udaipur during March 1958. Lighter infestations were present on regular cultivated plots but on newly ploughed lands populations were very high ranging from 5 to 11 cutworms per square foot. The habits and nature of damage of this insect were quite different from those

of the other cutworms reported as pests of potato in India.<sup>1,2</sup> This is the first record of the occurrence of this species as a pest.

The full-grown larvæ are brownish grey, plumpy and measure nearly 2" in length, and have the usual habit of curling the body tightly when disturbed. They are exclusively subterranean species and move entirely underground and cut off the plant 1-2" below the surface resulting in the death of the plant. Most of the damage, however, occurs on the tubers buried upto 3" deep in the ridges. They eat on the tubers by chewing cavities and are found resting inside them (Fig. 1). A number of



FIG. 1. The resting cutworms inside the damaged potato tubers. ◊

square foot sample ridges containing 6-10 larvæ were carefully examined and observed to have 30-35% of the tubers damaged. Such losses in yield present a real economic problem to the farmers.

The larva transforms into a pupa by making a rough earthen cocoon in the field under protective cover of any nature. The pupal period lasts about 10 days under conditions prevalent in late March and April. The adults, after emergence, tend to rest on or around herbaceous plants commonly found near the fields.

In a small plot BHC and aldrin were tried each at 2lb. actual toxicant per acre by incorporating the dusts in the soil and earthing up the ridges again. None of these applications gave any satisfactory protection to the tubers. This method was not attempted further because of the lack of knowledge of the possible residue hazards with such chemicals and the danger of imparting off-flavour or undesirable odour to the potatoes which were reaching maturity. The post-harvest larval count in one of the infested fields under observation averaged as high as 10 cutworms per square foot.

The author is indebted to Dr. A. Rathore, Principal, for providing facilities and encouragement for this work. Thanks are also due to Head of the Division of Entomology, Indian Agriculture Research Institute, New Delhi, for identification of the insect.

Dept. of Agri.

B. K. SRIVASTAVA.

Zool. & Ent.,

Rajasthan College of Agriculture,

Udaipur, July 25, 1958.

1. Kadam, M. V. and Patel, G. A., *Pest of Some Vegetables—Crisp Pests and How to Fight Them*, Bombay Govt. Publication, 1956, 78-90.
2. Srivastava, A. S., *Plant Protection Service in Uttar Pradesh*, Bureau of Agricultural Information, U.P., Lucknow, 1956, 22 pp.

#### SPERMATOGONIAL CHROMOSOMES OF TWO LIZARDS, *HEMIDACTYLUS* *BROOKI* GREY AND *VARANUS* *MONITOR* LINN.

THE diploid karyotype of *Hemidactylus brooki* (Fig. 1) shows 40 elements, comprising 24 macro- and 16 micro-chromosomes. The macro-chromosomes consist of 4 V-shaped and 20 rod-shaped chromosomes. The arms of the V-shaped chromosomes are of unequal lengths and are sub-medially attached to the spindle fibres. The rod-shaped chromosomes appear to be acrocentric in nature and are all of intergrading sizes. The points of their spindle fibre attachment are generally directed towards the centre of the spindle. The micro-chromosome part of the karyotype consists of 16 dot-shaped bodies of different sizes. Their extreme smallness makes it difficult to observe clearly the mode of spindle fibre attachment but, in all probability, they are telomitic in nature. They always occupy a central position in the spindle and are surrounded by the macro-chromosomes, which constitute a peripheral ring round them,

The chromosome complement of the male karyotype in *H. brooki* is :

$$4 V's + 20 R's + 16 D's = 40$$

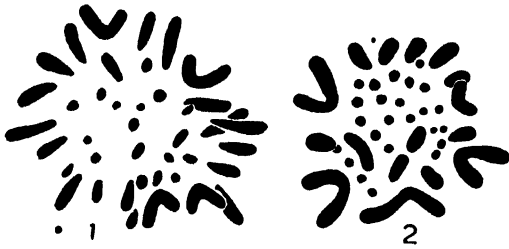

FIG. 1. Polar view of Spermatogonial Metaphase in *Hemidactylus brooki*,  $\times 4,000$  (approx.).

FIG. 2. Polar view of Spermatogonial Metaphase in *Varanus monitor*,  $\times 4,000$  (approx.).

In a polar view of the spermatogonial metaphase (Fig. 2) in *Varanus monitor*, 40 elements are always counted, and like the spermatogonial chromosomes of *H. brooki*, the components of this chromosome complex can also be distinguished into macro- and micro-chromo-

somes. A morphological analysis of the various elements shows that the macro-chromosomes, which are 16 in number, consist of 6 V-shaped and 10 rod-shaped chromosomes. The 4 bigger V-shaped chromosomes are sub-median, while the remaining 2, median in spindle fibre attachment. The rod-shaped chromosomes are all acrocentric in nature. The micro-chromosomes, which consist of dot-shaped chromosomes, generally remain dispersed inside the peripheral ring formed by the macro-chromosomes. Most of these dot-shaped chromosomes do not show much size difference and appear to be terminal in spindle fibre attachment. The

$$6 V's + 10 R's + 24 D's = 40$$

guidance the present investigations were carried out.

Dept. of Zoology,  
Univ. of Allahabad,  
Allahabad, May 29, 1958.

Karyotypes of 7 species of lacertilians, belonging to the family Geckonidae, have been studied so far. Table I shows the various details.

The chromosome complement of *H. brooki* appears to be quite interesting as it differs in one way or other from all those hitherto described.

From the family Varanidae, chromosomes of a single species, *Varanus gouldi*, have been studied so far (Matthey<sup>5,7</sup>). The diploid chromosome complex in this species also shows 40 elements but the number of V-shaped metacentric chromosomes is 8 as compared to 6 seen in *V. monitor*. Moreover, the rod-shaped chromosomes show an increase in number by two elements in *V. monitor*. Consequently, the fundamental chromosome number also differs—it is 46 in *V. monitor* and 48 in *V. gouldi*.

The author wishes to express his indebtedness to Prof. M. D. L. Srivastava under whose

TABLE I

Species	Sex	By whom worked out	Chromosome formula	Fundamental chromosome no.
<i>Hemidactylus flaviviridis</i>	♂	Asana and Mahabale <sup>1</sup>	46 R's	46
<i>Hemidactylus bowreni</i>	♂	Nakamura <sup>2</sup>	46 R's	46
<i>Hemidactylus frenatus</i>	♂	Makino and Momma <sup>3</sup>	46 R's	46
<i>Gekko japonicus</i>	♂	Nakamura <sup>2</sup>	4 V's + 34 R's	42
<i>Gekko japonicus</i>	♂	Su Hsuen <sup>4</sup>	40 R's	40
<i>Tarentola mauritanica</i>	♂	Matthey <sup>5,7</sup>	42 R's	42
<i>Gymnodactylus millisi</i>	♂	Matthey <sup>6,7</sup>	38 R's	38
<i>Gehyla variegata ogasawarasima</i>	♂	Makino and Momma <sup>3</sup>	63 R's	63

V = Metacentric, includes V- and J-shaped. R = Acrocentric includes rod- and dot-shaped.

some. A morphological analysis of the various elements shows that the macro-chromosomes, which are 16 in number, consist of 6 V-shaped and 10 rod-shaped chromosomes. The 4 bigger V-shaped chromosomes are sub-median, while the remaining 2, median in spindle fibre attachment. The rod-shaped chromosomes are all acrocentric in nature. The micro-chromosomes, which consist of dot-shaped chromosomes, generally remain dispersed inside the peripheral ring formed by the macro-chromosomes. Most of these dot-shaped chromosomes do not show much size difference and appear to be terminal in spindle fibre attachment. The

guidance the present investigations were carried out.

Dept. of Zoology,  
Univ. of Allahabad,  
Allahabad, May 29, 1958.

A. N. BHATNAGAR.

- Asana, J. J. and Mahabale, T. S., *Curr. Sci.*, 1941, 10 (11) 494.
- Nakamura, K., *Cytologia*, Tokyo, 1932 3, 156.
- Makino, S. and Momma, E., *Ibid.*, 1949, 15 96.
- Su-Hsuen, Wu., *J. Morph.*, 1933 54, 593.
- Matthey, R., *Rev. Suisse. Zool.*, 1931, 38, 117.
- , *Ibid.*, 1933, 40 281.
- , *Les chromosomes des Vertebres.*, F. Rouge, Lausanne, 1949.



## REVIEWS

**Technology and the Academics.** By Sir Eric Ashby. (Macmillan & Co.), 1958. Pp. vii + 118. Price 15 sh.

Universities preserve through centuries a recognisable individuality and identity of pattern. This survival of identity is a sign that they have adapted themselves to successive cultural environments. In this little book the author gives a masterly exposition of how British and Scottish universities reacted, slowly but surely, to the intellectual outlook of the people following the scientific revolution that started in England and spread through the continent.

It is legitimate to speak of a scientific revolution, for although there has been no age since the time of Aristotle without its scientists, there was, contained within two or three generations in the seventeenth century, a unique flowering of genius—Kepler, Galileo, Harvey, Boyle, Newton, Lavoisier—which reorientated the thought of Western Man.

The continental countries quickly reacted to this new scientific outlook. By 1800 the scientific spirit was firmly established in France and had permeated its education. From France it crossed the Rhine to Germany where it combined with the *Wissenschaft* of the early German humanists, and by the middle of the 19th century the Universities of Germany had adapted themselves wonderfully to the scientific age and led the world in research.

The full impact of the scientific revolution came back to British universities from the Laboratories of Germany. It emancipated Oxford and Cambridge from the constraints of dogmatic knowledge, and universities became centres of scientific research. This awakening coincided in time with pressure from big centres of population to have their own colleges for higher education and within the decade 1871 to 1881 seven Civic Universities were established.

With the growing necessity to maintain industrial supremacy in the midst of keen competition from the continental countries, the government stepped in to give State support for higher technological education and today 18 out of 22 British Universities include technology in their curricula. Yet the split personality in universities continues—the antithesis between imparting a liberal, 'gentlemanly' education and teaching tendentious knowledge. Technology

which is 'unashamedly tendentious' is tolerated but not assimilated. Until this ambiguity is resolved the Universities will not have adapted themselves to one of the major consequences of the scientific revolution.

The author puts in a strong plea for the inclusion of technology in a liberal education so that technology may become the core of a new twentieth-century humanism.

The book which is attractively got up, is sure to have a wide appeal to educationists, administrators and those interested in educational planning in the present age.

A. S. G.

**Synchronous Motors and Condensers.** By D. D. Stephen. (Chapman & Hall), 1958. Pp. ix + 500. Price 60 sh. net.

A large percentage of electrical power consumed by industry is used to drive induction motors in view of the fact that they are the cheapest form of A.C. motors in the smaller sizes. Next in importance are the synchronous motors which have been used for large motor drives as the advantages of high efficiency, operation at a fixed speed or the possibility of running at unity or a leading power factor have frequently made these more economic propositions. Synchronous motors are now being increasingly used for a wide variety of industrial purposes such as steel rolling mills, cement grinding mills, mixers, crushers, grinders, pumps, fans, for driving D.C. generators, etc. With a growing recognition of the use of controlled kvar for transmission of power, synchronous condensers have an important role to play as sources of controlled kvar.

The book under review is intended as introduction to the characteristics of synchronous motors and condensers and discusses the problems encountered when selecting the most suitable type of equipment for particular application. It is one of a series of *Advanced Engineering Text-Books* written by the technical staff of the B. T. H. Co.

The book is divided into twelve chapters. Chapter I is of an introductory nature and deals in a general way with the choice of type of motor. Chapters II and IV deal respectively with the steady state and transient characteristics of synchronous motors. Chapter III is de-

voted to power factor correction and excitation control. In Chapters V, VI and VII, starting characteristics, starting methods and starting schemes are discussed in great detail. Prevention of machine failure and protective devices are dealt with in the succeeding two Chapters. Chapters X and XI are devoted to a consideration of application problems, selection of motor and control equipment.

Power System Engineers would find Chapter XII to be of special interest to them as it deals exclusively with the operating characteristics and application problems of synchronous condensers.

In determining the most desirable rating for a motor it is necessary to consider a number of factors such as (a) factors determined mainly by the load characteristics, (b) factors determining the class of insulation and allowable temperature rise and (c) factors affecting the cost and size of a motor. It is possible to design any type of motor for any application but the size and cost may have to be increased appreciably. The choice of motor and starting method should be based on economic grounds in conjunction with technical desirability. Some of the most usual applications and their special requirements have been clearly and fully discussed. The book would, therefore, be of great interest to application or plant engineers responsible for the choice and installation of electric motors for industrial purposes. Students of electrical engineering would also find the book, a useful reference. I have no doubt in my mind that the book is worthy of a place in all technical libraries.

H. N. RAMACHANDRA RAO.

**How Television Works.** By W. A. Holm. (Philips Technical Library), 1958. Pp. 318. Price Rs. 18.94.

Excellent books on television dealing with the subject in a rigorous fashion are available, and these demand a fairly high standard of knowledge of radio engineering and higher mathematics on the part of the reader. The book under review, however, presents the subject in a very palatable form to the interested reader who has had no more than a nodding acquaintance with electronics.

The book consists of six parts: (I) Principles of Picture Transmission, (II) Electronic Scanning, (III) The Video Signal, (IV) Oscillations: Electronic Tubes: Pulses, (V) The Complete Television Signal, and (VI) The Television Receiver. The heart of the television equipment is the pick-up tube which converts the picture of the

scene projected on to its sensitive element into electrical pulses. The tube in current use known as the image orthicon, which bases itself for its function on photo-sensitivity, is the culmination of years of research in evolving suitable materials and novel design procedure. The story of the tube is a sequel to the experience gained in the construction of its forerunners. The electronic scanning methods employed in these tubes, and the function of the different elements are explained in a very objective fashion.

The signal from a television transmitter designated as the video signal is a combination of signals of different kinds, each one carrying an important message, to ensure that the receiver works in absolute synchronism with the transmitter. Part 3 deals with this aspect.

In Parts 4 and 5 problems of generating oscillations and pulses are dealt with, and also the modulation and radiation of electromagnetic waves. The sixth part describes the complete television receiver.

The book begins with an introduction to the principles underlying television and the difficulties of the earlier pioneers in the field.

Starting from first principles, all salient features of a modern television receiver are explained. The treatment adopted is non-mathematical and the physical principles involved in picture transmission and reception are delightfully presented with numerous illustrative diagrams.

The book is written in clear lucid style and anyone who wishes to have a correct and good appreciation of this subject would, in the opinion of the reviewer, profit greatly by reading this book.

A. J.

**Evolution by Natural Selection.** By Darwin and Wallace. (Cambridge University Press). 1958. Pp. 279. Price 25 sh. net.

This volume is published to commemorate the centenary of Darwin-Wallace Theory of Evolution by Natural Selection. There is an illuminating foreword by Sir Gavin de Beer in which he shows that the unprecedented advance of biological knowledge during the hundred years that have elapsed since the publication of the theory "does nothing but confirm it (the theory), even if new formulations are required as knowledge increases". The foreword is followed by an introduction by Sir Francis Darwin written in 1909, tracing the development of the evolutionary idea and the theory of Natural Selection in Darwin's mind. When he started

on his voyage on the *Beagle* his opinions were on the side of immutability of species. By 1837 he became a convinced evolutionist though he wrote the first sketch of the theory only in 1842. In Darwin's own words "In June 1842 I first allowed myself the satisfaction of writing a very brief abstract of my theory in pencil of 35 pages; and this was enlarged during the summer of 1844 into one of 230 pages". The sketch of 1842 and the essay of 1844 occupy pages 41 to 88 and 91 to 254 of the book. They are the forerunners of the "Origin of Species" and like it are an elaborate argument to show that the mutability of species under selection in nature is the only possible inference from the observed facts of organic nature. The last 22 pages of the book are devoted to the Darwin-Wallace papers of 1858 through which the Theory of Evolution by Natural Selection came to be known to the world.

The essay of 1844 is shorter and more pointed and so more readable than the "Origin". But it is less known than the "Origin" and hardly available, so that the reprinting of it in this book is valuable. Wallace's essay makes refreshing reading. Though eclipsed by Darwin in the eyes of the general public due credit should go to him for his independent discovery of the principle of Evolution by Natural Selection.

From a close reading of the original papers contained in this book one gets the impression that the only serious flaw in the theory as propounded by Darwin relates to his ideas of heredity. He believed in the inheritance of the so-called acquired characters and 'blending' inheritance both of which have been superseded by Mendelian particulate inheritance. It is only in this part of the theory that reformulation becomes necessary in the light of modern knowledge. In fact, as pointed out in the foreword, even in 1844 Darwin had correct knowledge of the variations of the first and second generations of hybrid progeny. But at that stage of biological knowledge he did not realize the significance of it as Mendel did 21 years later.

In making the original papers of Darwin and Wallace available this attractively got up Centenary Commemorative volume serves a real need. P. K. MENON.

**Recent Progress in Hormone Research.** Edited by G. Pincus. (Academic Press, Inc., Publishers, New York), 1957. Fp. vi + 646. Price \$ 12.00.

*Recent Progress in Hormone Research*, Vol. 13, represents a collection of papers and

discussions at the Thirteenth Annual Laurentian Hormone Conference held in Canada in 1956. The subject-matter has been grouped under five sections covering rather wide areas of inquiry in the field of endocrinology.

The volume opens with the section on 'Neuro-Endocrine Relationship'. This large problem has been diversely attacked by the Bethesda group, Greer and Richter. The serotonin problem has been reviewed and brought up-to-date by Udenfriend and his colleagues. They have repeatedly emphasized that in spite of the attention and investigative efforts bestowed on this substance, its physiologic role in the body still awaits elucidation. By a series of elegant experiments, Anderson *et al.* have been able to demonstrate profound metabolic alterations and disturbance in hypothalamohypophysial mechanism of release of ACTH and TSH in the dog, after transection of the spinal cord or the mid-brain. They have postulated the existence of a mesencephalic hypothalamohypophysial excitatory system. Greer has presented meticulous data on the hypothalamic control of pituitary TSH, GTH and ACTH activity. He has aptly pointed out the possible vital role of the reciprocal 'push-pull' mechanism between the circulating level of the target gland hormone and the production of appropriate pituitary trophic factor in neuroendocrine control. He believes that part of this mechanism operates *directly* at the pituitary level and part through a depression of the appropriate hypothalamic or other nervous centres. The reviewer is in full agreement with these views. It may not be out of place here to mention that there is a tendency among some enthusiastic neurophysiologists to ignore such possibilities and regard the hypothalamus as the sole custodian of the secretory potentialities of the hypophysis. Greer's views find support in Richter's studies on 'Hormones and Rhythms'.

The fascinating problem of the hormone transport in circulation has been the subject-matter of Section II. Robbins and Rall have dealt with the binding of thyroxine with the specific serum globulin (TBP) in euthyroid, hypothyroid and hyperthyroid patients. Sandberg *et al.* have adduced valuable data relative to the binding of various steroid hormones (estrogens, progesterone, testosterone and glucocorticoids) and their conjugates to plasma proteins. The steroids are probably transferred in such bound form in the body although the binding is of a weak and reversible nature. The liver does not seem to play an important role in this process

in spite of the fact that it may form strongly bound steroid-protein complexes. An interesting finding by these authors is the role played by the erythrocytes in the transport of some steroids in the body.

In the section on aspects of reproduction, Shelesnyak has presented extensive studies on the mechanism of ova-transplantation in rat. He believes that histamine is involved in decidual cell transformations and nidation in this species. He has marshalled very impressive evidence in support of his view which, if substantiated and extended to other species, will be an outstanding contribution in mammalian reproductive physiology. Rock *et al.*'s paper on synthetic progestogens is a detailed account of their work published previously (*Science*, 124, 891, 1956). The views expressed by one of the eminent discussants (Hartman) of this paper about the hazards involved in the steady use of these compounds by the normal human female merit careful consideration. Davis and Plotz have presented clinical data based on sound endocrinologic rationale regarding the beneficial use of progesterone in patients who have had habitual abortions. They have also provided a schema of biogenesis and metabolism of progesterone. Junkman has traced the evolution of long-acting estrogens, androgen, and progestogens and has discussed their probable mode of action.

The section on hormone chemistry and metabolism is prefaced by Mirsky's comprehensive studies on the relationship of the so-called "Insulinase" and "Insulin-inhibitors" to diabetes mellitus. The "Insulinase" approach to diabetes problem has certainly illuminated a path but has not yet brought us to the goal. The same may be said about glucagon, the progress of research on which has been admirably reviewed by Foa and his colleagues.

The book concludes with two apparently unrelated but basically interlinked papers on 'Hormones and Stress'. In the first of these, Moore has presented extensive data on endocrine changes after anaesthesia, surgery and unanaesthetized trauma of different magnitude in man. Gray and Ramsay have reviewed clinical and experimental evidence for an adrenal-gastric relationship in man, integrating the gastric and peptic glands into the general endocrine mechanisms.

The present volume of *Recent Progress in Hormone Research* like its predecessors, is a worthy publication and research workers in the ever-expanding field of endocrinology would

look forward to the regular appearance of other volumes in this 'Recent Progress' series.

B. MUKERJI.

**Introduction to Enzymology.** Editor: Alan H. Mehler. (Academic Press, Inc., New York: India: Asia Publishing House, Bombay-1), 1957. Pp. 425. Price \$ 10.80.

Enzymes play the same important role in biochemistry in the present decade which vitamins and hormones did in the last two, and so quite a few books on enzymes have appeared recently. Most of the treatises published on enzymology till now, however, have been presented, on the whole, from a physico-chemical view-point—description of general properties of enzymes, purification, kinetic studies, etc., followed by a study of the principal groups of enzymes classified according to the kind of chemical transformation they catalyze.

This method of presentation has the defect of not indicating clearly the enzymatic interrelations in intermediary metabolism. It is to remedy this defect that A. H. Mehler has published a book based on the course in enzyme chemistry taught by him at the National Institute of Arthritis and Metabolic Diseases. The portion reserved for the general characteristics of enzymes has been reduced to a strict minimum necessary to understand the succeeding chapters. This reviewer, however, feels that a general approach to the isolation and purification of enzymes could have been profitably included in the introduction.

The author deals in a series of chapters the principal metabolic transformations; he describes also for each of these the essential properties of the multiple enzymes catalyzing the transformations one after the other.

This method of presentation is more empirical than that adopted in the text-books of enzymology treated—from a physico-chemical view-point, but it appears to succeed in its aim. In fact, the grouping in the same chapter of enzymes taking part successively and simultaneously clears up for us the complexity of the metabolic processes. The author has lifted the artificial barriers of biology and has tried to show us the dynamics of biological reactions at a cellular level.

In a series of chapters the author describes: Hydrolysis of Peptides and proteins; Fermentation and Oxidation of Major Metabolic Fuels (Carbohydrates and Fatty Acids); Biological Oxidation; Sugar and Sugar derivatives; Polynucleotides and their Components;

Amino Acids; Acids and Acid Derivatives; and, Organization of Structure and Function.

The book surpasses the ordinary class of introductory manuals of enzymology; it is also more than just an abstract of enzymological work dealing with intermediary metabolism. The books in this latter domain are so many and so varied that it is impossible to have an over-all idea of enzymology.

In a field where advance in knowledge is taking place practically every day, it is not easy to keep track of all the current literature on the subject included in the book. Nevertheless, it may be pertinent to point out two omissions which might have been avoided. Under "Purine Biosynthesis", both in figure 26 on page 265 and in the text on page 266 a tentative intermediate has been postulated between 5-aminoimidazole ribotide and aminoimidazole carboxamide ribotide, i.e., 5-amino 4-imidazole N-succinyl carboxamide ribotide. Not only this intermediate but also its immediate precursor—5-aminoimidazole carboxylic acid ribotide was isolated and identified by Lukens and Buchanan (*J. Am. Chem. Soc.*, 79, 1511, 1957), thus filling the gap in our knowledge of purine biosynthesis some six months before the book was apparently sent to the press. The other omission occurs on page 30, where the statement is made that "gluconate is oxidized to 2-ketogluconate by incompletely described bacterial enzymes". Actually the isolation and purification of gluconic dehydrogenase were reported a few years back (*Biochim. et Biophys. acta*, 17, 122, 1955).

In spite of these minor criticisms, *Introduction to Enzymology* is an excellent text, not only to students of enzymology, but also for students of general biochemistry.

T. RAMAKRISHNAN.

**Genetics and Plant Breeding in South Asia—**  
(An International Symposium sponsored by the Indian Society of Genetics and Plant Breeding and UNESCO, South Asia Science Corporation, Office—Delhi), Jan. 21-25, 1957. *Indian Journal of Genetics and Plant Breeding*, 17, No. 2, Special Symposium Number.

In this Symposium inaugurated by Dr. B. N. Uppal, some of India's leading workers in the subject, as well as the foreign visitors, Dr. G. L. Stebbins of California University, Dr. O. H. Frankel of the Darwin Institute of Plant Industry, CSIRO, Canberra, Australia, and Dr. A. Gustafsson of the Forest Research Institute, Sweden, have taken part. Of the 24 papers discussed, half the number relates to crop breeding, and the rest to other aspects, viz., genetics,

cytogenetics, physiology, and plant introduction.

The Breeding Section covers a wide range of field crops—cereals, fibres, tubers, tobacco, sugarcane and nine different types of oilseeds. As expected, emphasis is directed to problems and their solutions peculiar to South Asian regions and to an assessment of Indian achievements in the field. As is well known, in modern plant breeding methods of hybrid production and the intervarietal transfer of genes have been developed to a high degree of efficiency; but the more complex phenomena of cytogenetics associated with induced polyploidy, induced mutation, and gene transfer across interspecific barriers are also opening up newer vistas of investigation. This widening horizon of the plant breeder is excellently revealed by Dr. Stebbins in his critical contribution to this Symposium.

Closely connected with breeding programmes is Plant Introduction, and two important aspects of this are discussed by Dr. Frankel and Prof. L. S. S. Kumár.

As in other spheres, any programme of breeding resistance to disease and insect pests requires the well-planned and co-operative effort of team workers—breeder, geneticist, pathologist, entomologist, biometrician, technologist. The importance of this need for co-ordination is indicated by Dr. A. B. Joshi in the Genetics Section. Dr. P. Maheshwari's contribution entitled "Hormones in Reproduction" deserves special attention for its excellent condensation of the important aspects of this new field of inquiry. The exciting possibilities of the new technique of "test-tube" fruit production and the biological action of the recently discovered kinins and gibberellins cannot fail to stimulate the inquiring research mind and lead it along fresh avenues of exploration in the promising field of Experimental Plant Embryology.

The two papers on mutation research evoke an appeal like that of new discovery being noteworthy for the hopeful notes they strike. Dr. M. S. Swaminathan reveals the prospect of the geneticist inducing useful mutation in polyploids. This is encouraging, but perhaps not so exciting as the new possibilities indicated recently by Swedish mutation workers. As Dr. Gustafsson points out, there is now sufficient experimental proof to indicate that the mutation processes, once considered sporadic and unpredictable, may in the near future be controlled and directed by artificial means.

*The Indian Journal of Genetics and Plant Breeding* is to be congratulated for producing

this volume of high technical excellence. It contains a wealth of ideas and information not only indispensable to workers in these and associated fields, but also to advanced students of Botany and Agriculture in our Universities

H. D. NORONHA.

**Chemical Aspects of Ecology in Relation to Agriculture.** By Hubert Martin. (Science Service Laboratory, University of London, Ontario), 1957. Pp. 96. Price \$ 3.00.

A review of certain basic problems concerning host parasite relationship, as also available information on the biologically active chemicals present in the crop environment and involved in the intricate phenomenon of parasitism, is presented. The book is a clear and stimulating survey of present knowledge of the antibiosis and symbiosis which are of fundamental importance in crop production. It provides clear indication as to the gaps in our knowledge and the lines on which further information must be sought for. The control of insect pests through production of resistant varieties of crop plants is, no doubt, attractive but it appears there is considerable scope for exploitation of the toxic or deterrent substances present in the plants for use in plant protection. In this direction, some outstanding cases have been quoted, such as the resistance of *Solanum demissum* to the larvæ of Colorado beetle which has been ascribed to "Tomatin" content. It is further indicated that basis of gall formation or other malformations as a reaction of plants to insect attack require fuller investigation.

The parasitism may be established by fungi on account of the toxins secreted by them in advance of actual infection or as a reaction of host and pathogen so that it is difficult to generalise this until more information on the mode of action of fungi is available on a variety of phytopathogenic fungi. The potentialities of biological control in plant diseases have been reviewed and information on the successful use of some of those so far employed has been clearly brought out. This aspect, it is indicated, requires further research with a view to its practical utilization on a much wider scale than hitherto practised.

The author has done great service to those interested in the fundamental study of exploitation of natural resources in Plant Protection by providing direct evidence available on the subject under one cover.

R. S. VASUDEVA.

Books Received

*Biophysical Chemistry*, Vol. I. (*Thermodynamics, Electrostatics and the Biological Significance of the Properties of Matter*). By J. T. Edsall and J. Wyman. (Academic Press, New York; India: Asia Publishing House, Bombay-1), 1958. Pp. xv + 699. Price \$ 14.00.

*Dry-cleaning Technology and Theory*. By A. R. Martin and G. P. Fulton. (Interscience Publishers, Inc., New York), 1958. Pp. viii + 269. Price \$ 6.00.

*British Medical Bulletin—Causation of Cancer*, Vol. 14, No. 2. (Medical Department, The British Council, 65, Davies Street, London W. 1), 1958. Pp. 73-196. Price 25 sh.

*Discovery Reports*, Vol. XXIX. (*The Distribution of the Cœtognatha of the Southern Ocean*). By P. M. David. (Cambridge University Press, London), 1958. Pp. 199-228. Price 18 sh. 6d.

*Applied Mathematics and Mechanics*, Vol. III. (*Mathematical Theory of Compressible Fluid Flow*). By R. von Mises. Completed by H. Gejring, & S. S. Ludford. (Academic Press, New York; India: Asia Publishing House, Bombay-1), 1958. Pp. xiii + 514. Price \$ 15.00.

*Some Catalytic Gas Reactions of Industrial Importance*. By J. C. Ghosh, S. K. Bhattacharya and M. V. C. Sastry. (The Director, Oriental Institute, Baroda.) Pp. xi + 355. Price Rs. 13.50.

*Sound Pulses—Cambridge Monographs on Mechanics and Applied Mathematics*. By F. G. Friedlander. (Cambridge University Press, London, N.W. 1), 1958. Pp. xi + 202. Price 40 sh.

*Advanced Engineering Text-Books—Conformal Transformations in Electrical Engineering*. By W. J. Gibbs. (Chapman & Hall, London, W.C. 2; India: Asia Publishing House, Bombay-1), 1958. Pp. viii + 219. Price 45 sh.

*Pre-Stressed Concrete—Theory and Design*. By R. E. Evans and E. W. Bennett. (Chapman & Hall, London, W.C. 2; India: Asia Publishing House, Bombay-1), 1958. Pp. xv + 294. Price 60 sh.

*Advances in Petroleum Chemistry and Refining*, Vol. I. Edited by K. A. Kobe and J. J. McKetta Jr. (Interscience Publishers, Inc., New York-1), 1958. Pp. xv + 641. Price \$ 13.50.

*Indigenous Drugs of India*. Second Edition. By R. N. Chopra, I. C. Chopra, K. L. Handa and L. D. Kapur. (U. N. Dhur & Sons, 15, Bankim Chatterjee Road, Calcutta-12.) Pp. xxxii + 816. Price not given.

---



---

## SCIENCE NOTES AND NEWS

---



---

### Detection of Mustard Oil Used as Adulterant

Shri S. N. Mitra and Shri P. N. Sengupta of the Central Food Laboratory, Calcutta, report a simple method of detecting mustard oil used as an adulterant in other edible oils. The method consists in reducing the volatile essential oil of mustard, which contains sulphur, by nascent hydrogen and the  $H_2S$  evolved is detected by lead acetate paper. To about 10 ml. of the oil in a boiling tube are added 10-15 ml. of dilute hydrochloric acid (1:1) and a few large pieces of pure zinc metal. A strip of moist lead acetate paper, pinned to the cork, is hung inside the tube. If mustard oil is present, with the slow evolution of hydrogen over a period of one to two hours, depending on the quantity of the adulterant present, the lead acetate paper will blacken gradually.

### Naphthalene as Deterrents for Snakes

Shri B. K. Sharma (Vigyan Mandir Officer, Sundernagar, H.P.) reports that naphthalene balls act as deterrents for snakes. The belief that onion, garlic or ginger keeps away snakes has been found to be untrue.

Observations made on three snakes in a cage showed that they were not affected at all by onions, garlic or ginger kept inside the cage, whereas with naphthalene balls they became sluggish after 24 hours and died successively one after the other within 3 days.

### Velocity of Light

Results of tests by scientists at Columbia University in September were reported as confirming again—in their suggestion that the velocity of light is constant—Einstein's Special Theory on Relativity.

In the Columbia experiment, it is said, the theory that light should move at a constant velocity regardless of the motion of observers was tested with a precision never attained before, a precision made possible by the use of an electronic device, the "maser" (see *Curr. Sci.*, 27, p. 117).

"The maser has a cavity into which is directed a beam of ammonia particles accelerated to high speed. The molecules vibrate in the cavity and give off radio waves. Measurement of the frequency of the generated radio

waves provides a precise measurement of the passage of time when the masers are used as atomic clocks."

The research group mounted two masers—with their ammonia beams pointing in opposite directions—on an instrument panel that could be rotated through 360°. The masers were pointed east and west and the frequency of the radio waves generated by the speeding ammonia particles was determined. Then the equipment was rotated 180° and a new determination was made.

In the experiment, frequencies of radio waves generated when the ammonia beams were aimed with the earth's motion were compared with frequencies of waves generated when the beams were aimed in the opposite direction. The comparison was made to an accuracy of one part in a million millions.

The experiment was repeated many times. Calculations had shown that if the earth's motion round the sun altered the observed light velocity, this should disclose a difference of 20 cycles a second in the frequencies between the maser ammonia beams pointed east and west. "Actually, a difference of about one cycle a second was found throughout the day. But this, the experimenters said, was caused by the earth's magnetic field and the magnetic influence of other electrical equipment in the (university's) Watson Laboratory. Outside the magnetic effects no variation greater than a fiftieth of a cycle a second was observed."—*Science Newsletter*, 4487.

### Volcanic Eruption on Moon

The Soviet astronomer Dr. Nikolai Kozyrev has registered a volcanic eruption on the Moon.

Observing the lunar surface with a 50" reflector of the Crimea Astrophysical Observatory, he took a surprising snapshot of the central peak of the "Alphonse" crater at about 4 hours Moscow Time on November 3. The crater had a reddish hue greatly weakened by violet rays. For 30 minutes after 6 hours of the same day, the brightness of the peak suddenly doubled. Bright lines of carbon and its components appeared in the peak's spectrum. There was one particularly bright line resembling those usually produced by molecular carbon.

Further photographs showed the crater in its natural state.

Dr. Kozyrev has taken 20 photographs of the "Alphonse" crater's spectrum during the past three weeks.

The present observations are of great scientific interest and are likely to upset the existing hypothesis about the origin of the main peculiarities of the lunar surface which ascribes them to the impact of meteorites striking the Moon. This volcanic eruption shows that the processes which are responsible for the characteristic features of the lunar landscape are similar to those on the earth for the formation of the mountain relief.

### The Nangal Heavy Water Plant

The Nangal Heavy Water Plant, whose construction has been undertaken by the Government of India, is expected to produce 14 metric tons of heavy water per year and 70,000 metric tons of nitrogen as nitro-limestone.

Investigations of the feasibility of producing heavy water in India began early in 1954. At that time, information was available on only two processes—electrolysis and water distillation. Because it was felt that water distillation was a very expensive process, electrolysis of water was adopted as the method of primary enrichment with another, then undetermined, method for final concentration.

In response to an invitation, detailed reports were received from three firms in August 1956. Although all the processes suggested took advantage of the concentration obtained in the electrolyzers, different processes for the final  $D_2O$  enrichment were recommended, namely, ammonia distillation, catalytic exchange followed by water distillation, and hydrogen distillation.

On the basis of the data supplied by these firms in their reports, technical and economic evaluation of the three processes were made. As a result of this study it was concluded that although the catalytic exchange process was a well-known process and had a background of 10 years of industrial scale operation, the hydrogen distillation process treating a reduced amount of enriched hydrogen would be economically more attractive and technically more suitable for conditions in India. A cost analysis for a typical hydrogen distillation plant gives the total cost of production, including capital charges as \$ 28 (Rs. 140) per lb. of  $D_2O$ .

Compared to the above the Savannah River plant of the U.S. A.E.C., constructed in 1951-52 at a cost of \$ 164 million, gives the cost of production as \$ 30 per lb. of  $D_2O$ .

In this plant, heavy water is extracted from natural water using a combination of three processes :

(1) Dual temperature exchange between  $H_2S$  and water. The product from this step contains about 15%  $D_2O$ .

(2) Vacuum distillation—the product contains about 90%  $D_2O$ .

(3) Electrolysis—the end-product contains 99.75%. The production rate is 1 million lb.  $D_2O$  per year.—*Report to Geneva Atoms for Peace Conference.*

### Electronic Device for Assessing Uranium Ore

An electronic device, known as an ore grade discriminator, is an unusual piece of equipment at Australia's uranium mine at Mary Kathleen, in Queensland. Located between the mine and the acid treatment plant, the device assists in the bulk sorting of the uranium ore supplies.

The device is housed in an archway type of framework 16 ft high and consists of six Geiger tubes. Trucks containing ore from the mine pass under the arch on their way to the treatment plant. Gamma rays from the radium content of the ore react on the Geiger tubes which feed a "count" into a junction box, and in turn to a ratemeter. In a matter of only two seconds the ratemeter converts the total gamma ray count of the truck load into an equivalent uranium oxide percentage. The truck is then directed to the appropriate stockpile of ore, depending on its grade. The device is operated by only one man.

It was invented by Mr. R. Sterrett, a Tasmanian geophysicist, in conjunction with Mary Kathleen Uranium Ltd.'s chief geologist, Mr. F. Hughes. *Commonwealth of Australia News and Information Service*

### Radar with a Memory

A radar screen can now be made to show the whole path of the aeroplane or ship it has been observing over the preceding 20 minutes or less. It is made to do this by arranging that the stored images shall respond only to infra-red light, and this, in turn, is achieved by the development of a special phosphor coating for the cathode-ray tube.

With the new phosphor the tube can be given two coatings the one nearest the observer being the storage phosphor and the backing layer consisting of the normal coating capable of converting electron energy into blue, violet or ultra-violet light. The backing layer thus reproduces the immediate image; the layer



in the forefront yields its "remembered" images on demand from infra-red light.

This infra-red illumination also serves to erase the stored image so that the screen is clear for fresh impressions immediately after use has been made of it. The system thus is essentially one of controlled afterglow.

Hitherto, something of the same service of relating a sequence of images could be obtained by using a long-persistence phosphor which left a prolonged afterglow on the tube. This had the disadvantage of cluttering up the screen and making it unready to display new images. Also if the glow was required to persist for several minutes, permanent damage to the phosphor was likely.

With the help of the new phosphor and the infra-red light, the duration of the glow is determined by the operator. The light comes from a series of small-filament lamps fitted with filters which pass infra-red wavelengths and exclude most of the others. They are switched on and off at need.

The new type of phosphor, known as Y, has been developed by the Electronic Department of Ferranti Ltd.—*Science Newsletter*, 4577.

#### Germanium Thermometers for Near Absolute Zero Temperatures

Low-temperature research has highlighted the need for a reliable and sensitive thermometer, not requiring continual calibration, in the range of temperature near to the absolute zero. Kunzler, Geballe and Hull of Bell Telephone Laboratories have developed a Germanium resistance thermometer to satisfy the rigorous needs of low temperature calorimetry. Germanium can be doped with arsenic to produce a high and constant temperature coefficient at temperatures near to the boiling point of helium. The thermometer consists of a single crystal of arsenic-doped germanium,  $0.025 \times 0.02 \times 0.210$  inches, with attached current and potential leads and supported in a strain-free manner in a platinum-glass enclosure filled with a small amount of helium. A current of a fraction of a micro-ampere is passed through the crystal and the potential drop is measured. A typical thermometer had a resistance of 1 ohm at room temperature, 14 ohms at  $10^\circ$  K. and 216 ohms at  $2^\circ$  K. Both the temperature coefficient and the resistance vary with the amount of doping and thus thermometers of different characteristics can be made. Once calibrated the thermometer is accurate to  $10^{-4}$  of a degree at the boiling point of helium ( $4.2^\circ$  K.), even after repeated cycling from room temperature to  $1^\circ$  K.

#### Preserving Hard Wood with Oxy-welding

An unusual method for preserving hardwood poles, electrical transmission poles, and other timber structures contacting the ground and which is in use in Australia, employs oxy-welding for scouring and charring the timber. The technique prevents decay due to fungi termites, and other wood-destroying agents.

The high temperature flame produces a charred layer on the timber, and is hard, fine-textured and of comparatively strong adherence. It is of the right porosity to allow absorption, and retention of creosote preservative, which is applied with a pressure spray while the pole is still warm.—*Commonwealth of Australia News and Information Service*.

#### Microwave Chemistry

Much research is today being carried out on synthetic polymer materials in which the basic framework contains elements other than carbon, for example silicon, boron, phosphorus, or aluminum. So far, the only commercial products of this type are the silicones (built up of silicon-oxygen-silicon chains) and the valuable characteristics of silicones, such as thermal stability and water repellency, have encouraged work on other "inorganic" polymers in the hope that new materials with useful properties will be obtained.

It is against the background that interest attaches to the discovery of a new technique for preparing diboron tetrachloride,  $B_2Cl_4$ . This compound is a possible starting point for preparing polymers with both boron and carbon in the basic framework (for example, boron-carbon-carbon-boron chains), but until now it has been obtained only with difficulty.

J. W. Frazer and R. T. Holzmann of the Radiation Laboratory of the University of California have found (*Journal of the American Chemical Society*, 80, 2907) that if ordinary boron chloride ( $BCl_3$ ) is passed in gaseous form through a resonant cavity fed with microwave energy of about 12 cm. wavelength it becomes partially converted to diboron tetrachloride and chlorine.

No mechanism is suggested for the reaction, but it would seem probable that some kind of gas discharge may occur in the cavity in regions of high field strength; otherwise it is difficult to understand how the microwave energy could effect reaction. Frazer and Holzmann intend to investigate the new technique further and suggest that it might be applicable to other reactions.—*Science Newsletter*, 4576.

### Germanium as a Catalyst

The special electrical properties of germanium, which make it so useful in transistors, also enable it to act as a catalyst to accelerate certain chemical processes. It is prepared for this role by subjecting it to an electric discharge: apparently a number of chemically active electrons are thus concentrated on the surface. As a result weak chemical bonds can be formed with other materials, enabling the germanium to collect the reacting materials on its surface and release them as the chemical changes are completed. According to Dr. Y. L. Sandler, who has experimented with germanium at the Westinghouse Research Laboratory, its catalytic activity is as high as is found in the best known catalysts.—*Science Newsletter*, 4577.

### Electron-Exchange Resins—Organic Intermediates

Two methods of preparation are reported by NCL: (a) by reaction of quinones containing labile halogen atoms with alkali metal derivatives of polyhydroxy compounds, e.g., reaction of sodium cellulose or sodium polyvinyl alcohol, with tetrachloroquinone or 2:5-dichloromethylhydroquinone diacetate; or (b) by impregnation of hydrophilic materials with water-insoluble quinones. A wide range of quinones of varying redox potential can be used for this purpose, it is stated.

Applications for electron-exchange resins are: removal of  $O_2$  from boiler water or other solutions; preparation of hydrogen peroxide, in the reduced form as polymerisation inhibitors for vinyl resins and in the oxidised form as polymerisation catalysts for vinyl monomers; as anti-stain agents in photographic emulsions; as antioxidants, e.g., prevention of peroxides in ethers; potentially useful as prophylactics for ionising radiations which are not rapidly excreted from the body (not a general application); either member of the couples  $I^-/I_2$ ,  $Fe(CN)_6^{4-}/Fe(CN)_6^{3-}$ ;  $Fe^{2+}/Fe^{3+}$ ;  $Br^-/Br_2$  can be oxidised or reduced depending on the state of the resin.

Potential applications suggested are: very selective oxidation or reduction, without contamination, of certain components of a mixture; continuous flow oxidation or reduction of organic or inorganic compounds in solution; and study of unusual or unstable valency states of certain metals.—*Chemical Age*.

### Nitro-Paraffins as Substitute for Petrol

Prof. Ernest Starkman, Associate Professor of Aeronautical Engineering at the University of

California, has announced the results of initial tests with certain compounds, known as nitro-paraffins, made by mixing methane, propane, butane, and other petroleum products with nitric acids, the use of which, it is claimed, could double the power output of motor car and aircraft engines.

These compounds are relatively expensive, but the resultant fuel could be economical if produced in large quantities. Development of such a fuel could mean that engines using it would be less than half the size and weight of existing engines, but just as powerful.

Whether the nitro-paraffins are explosive is a matter of opinion among experts, but in Dr. Starkman's view they are not more dangerous than ordinary petrol. One problem still to be solved is that of pre-ignition, which occurs when an overheated engine causes premature explosion of the compressed fuel and air mixture. However, Dr. Starkman holds that present-day engines could probably be modified to use the new compounds without experiencing this trouble. The nitro-paraffins might be specially useful in diesel engines where pre-ignition is an advantage. The main use of the new fuels in ordinary car engines would probably be as secondary agents to provide sudden spurts of power.—*Science Newsletter*, 4578.

### Radioactive Sterilization of Insect Pests

In the past decade new synthetic insecticides have achieved great success in the control and eradication of insect-borne disease, but already their powers are seriously threatened by the emergence of many resistant strains. This intensifies the interest in an entirely new method of attacking insects by liberating large numbers of radioactively sterile individuals. The method depends on the well-known sensitivity of reproductive tissues to radiation. Doses of about 5,000 r (ten times the dose lethal to most mammals) can be given to certain insects in the pupal stage without greatly curtailing their lives; but the resulting adults are generally sterile. The females of many insects allow only a single mating, and if this has been with a sterile male the act is sufficient to prevent reproduction. To eradicate a pest, then, it is necessary to liberate sufficient numbers of sterile males to compete successfully with normal wild ones. That this is sometimes feasible has been shown by American workers who have exterminated the "screw worm" fly (which breeds in wounds and sores of animals) from the island of Curacao which has an area

of 170 square miles (440 sq. km.). The flies were reared in vast numbers, sterilized in a cobalt-60 irradiator, and released at the rate of about 400 males per square mile (150 per sq. km.) weekly for about 20 weeks.—*British Medical Journal*, Sept. 20, 1958.

### Radioactive Contamination of Food Crops

Radioactive contamination of food crops by Strontium-90 can be reduced by adding lime to the soil, according to Dr. F. B. Fowler of the University of California. Strontium-90 is chemically similar to calcium, one of the chief ingredients of bone. If taken into the body, it concentrates in the bone structures and may cause tumors. Since milk also contains calcium, poisoning could result from the milk of cows fed on contaminated pastures.

Dr. Fowler said that plants grown on soil high in calcium contain less strontium than those grown in low calcium soil. He and his research team noted that when the soil contained as much as one-half to one pound calcium per cubic foot of soil, the plant's uptake of Strontium-90 decreased sharply. They also found that some plants such as lettuce and lucerne seemed to prefer calcium to strontium. Grass, on the other hand, concentrated strontium as it grew.

Dr. Fowler said that if radioactive contamination ever becomes critical, man may be forced to eat food plants with metabolism similar to those of lettuce or lucerne.—*SASLO Newsletter*, 277.

### Why Liquids Flow

There has never been any wholly satisfactory explanation of the structure of liquids. Obviously the molecules must all be conforming to some recognisable pattern that gives liquids a unique identity of their own and sets them apart from solids on the one hand and gases on the other. But no one has yet discovered what that pattern might be.

Prof. J. D. Bernal has now put forward a completely new theory in which he claims to have finally identified the missing pattern, the key to what makes a liquid a liquid. Liquids get their unique character from the fact that

the molecules in them are neither rigidly dra-gooned, as they are in a solid, nor completely divorced from their neighbours, as they are in a gas.

The molecules in a solid always adopt formal, barrack-square patterns that are repeated over and over again. In a gas they move at random and make contact only when they accidentally collide. By contrast, the molecules in a liquid are in direct contact with each other, with uneven forces pushing and pulling the molecules from every direction. According to Prof. Bernal they do indeed form a pattern, but it is an irregular, patch-work quilt design that never repeats itself.

Liquid structure is based, he thinks, on a pentagon while solids form three-, four-, and six-sided structures. A pentagon is one shape that it is almost impossible to build into a regular pattern, and this is probably the underlying reason why liquids flow.—*Science Newsletter*, London, No. 388.

### Insdoc Report, 1957-58

The Indian National Scientific Documentation Centre which was established in 1952 by the Government of India with the technical assistance of UNESCO, provides a complete range of documentation services. During the past six years there has been a steady increase in the activities of the Centre.

During the period under report the Centre has complied with a total of 6,202 requests for documentation services out of 6,994 requests made. As compared to the previous year, the documentation services completed during the year show an increase of 15.2 per cent.

### Award of Research Degree

The University of Cambridge has awarded the Sc.D. Degree in Zoology to Dr. Vishwa Nath, Professor and Head of the Department of Zoology, Panjab University, Hoshiarpur.

The Karnatak University has awarded the Ph.D. Degree in Physics to Shri N. Sreedhara Murthy for his thesis, "Structure of Diatomic Molecules—Study of Electronic Transition Moment Variation in Bands of BeO".

---

1220-58. Printed at The Bangalore Press, Bangalore City, by C. Vasudeva Rao, Superintendent, and Published by A. V. Telang, M.A., for the Current Science Association, Bangalore.

All material intended for publication and books for review should be addressed to the Editor, *Current Science*, Raman Research Institute, Bangalore-6.

Business correspondence, remittances, subscriptions, advertisements, exchange journals, etc., should be addressed to the Manager, Current Science Association, Raman Research Institute, Bangalore-6.

India : Rs. 12-00. Foreign : Rs. 16-00; £ 1-4-0; \$ 4-00

Author Index

	PAGE		PAGE
ABEDI, Z. H. .. .. .	306	Bhat, J. V. .. .. .	171, 253
Abhiswar Sen .. .. .	341	Bhatnagar, A. N. .. .. .	504
Abraham, A. .. .. .	60	Bhatki, K. S. .. .. .	439
Abraham, E. V. .. .. .	410	Bhatnager, D. S. .. .. .	495
Achuta Rao, A. .. .. .	96, 345	Bhattacharjee, S. P. .. .. .	401
Agarwal, G. S. .. .. .	213	Bhavanarayana, P. V. .. .. .	57
Agarwal, S. C. .. .. .	107, 348	Bheemasankara Rao, C. .. .. .	482
Ahilya P. Jagtap (Miss) .. .. .	99	Bhide, V. G. .. .. .	167
A. J. (Rev.) 108, 147, 188, 271, 315, 362, .. .. .	507	Bhide, V. P. .. .. .	499
Alladi Ramakrishnan .. .. .	469	Bir, S. S. .. .. .	146
Ambash, R. S. .. .. .	445	Bose, M. N. .. .. .	312
Ambika Singh .. .. .	393	Brahmachari, H. D. .. .. .	440, 486
Anantakrishnan, C. P. .. .. .	255	B. R. S. (Rev.) .. .. .	113, 189
Anantakrishnan, S. V. .. .. .	438	Burundeb Banerjee .. .. .	56
— (Rev.) .. .. .	411	Butani, Dharmo, K. .. .. .	182, 405, 453
Anantaraman, R. .. .. .	390	Butany, W. T. .. .. .	354
Anantharaman, T. R. .. .. .	51, 238, 287	CAMA, H. R. (Rev.) .. .. .	71
Appala Raju, N. .. .. .	482	Chakravarti, S. C. .. .. .	32
Appa Rao, K. .. .. .	397	Chanda, R. .. .. .	102
Argikar, G. P. .. .. .	183	Charan Singh .. .. .	502
Arora, B. K. .. .. .	32	Chatterjea, J. N. .. .. .	342
A. S. (Rev.) .. .. .	111	Chaturvedi, R. K. .. .. .	246, 392
A. S. G. (Rev.) .. .. .	504	Chaudhary, S. S. .. .. .	409
Aswathanarayana, U. .. .. .	13	Cheema, P. S. .. .. .	343
Atal, C. K. .. .. .	268	Chinoy, J. J. .. .. .	141
BABAT, G. .. .. .	428	Chiranjivi Rao, K. .. .. .	218
Babu Rao, M. .. .. .	265	C. H. S. (Rev.) .. .. .	411
Babu, S. K. .. .. .	168	C. P. G. (Rev.) .. .. .	225
Balakrishnan, K. .. .. .	387	DAS GUPTA, S. K. .. .. .	132
Balakrishnan, M. S. .. .. .	307	Das Gupta, S. N. .. .. .	446
Balakrishna, S. .. .. .	251, 300	Datta Gupta, A. K. .. .. .	219
— (Rev.) .. .. .	271	Davis, T. A. .. .. .	145
Balarama Murty, C. .. .. .	249	Dehadrai, P. V. .. .. .	168
Baldev, B. .. .. .	104	De, M. N. (Rev.) .. .. .	36
Bali, P. N. .. .. .	405, 407	Deodikar, G. B. .. .. .	457
Baljit Singh .. .. .	393	Deshpande, R. C. (Rev.) .. .. .	187
Balwant Rai Puri .. .. .	53	Deshpande, W. M. .. .. .	485
Bansigir, K. G. .. .. .	436	Devadatta, S. C. (Rev.) .. .. .	112, 224
Bapna, K. R. .. .. .	259	Dey, Arun, K. .. .. .	244
Baveja, K. D. .. .. .	95	Dhillon, J. S. .. .. .	95
Behera, B. C. .. .. .	492	Dharampal Singh .. .. .	491
Bhagavantam, S. (Rev.) .. .. .	479	Dhadeshwar, B. V. .. .. .	51
Bhatia, B. S. .. .. .	300	Dhawan, N. L. (Rev.) .. .. .	36

	PAGE		PAGE
Dikshit, P. K. .. .. .	250	Jain, N. C. .. .. .	97
Divakaran, K. .. .. .	100	Jain, N. P. .. .. .	20
D. J. B. (Rev.) .. .. .	110	Jain, P. C. .. .. .	340
Dronamraju, Krishna, R. .. .. .	452	Jain, R. K. .. .. .	394
Dutt, B. S. M. .. .. .	501	Jain, S. L. .. .. .	449
Dutt, N. .. .. .	179	Janaki, I. P. .. .. .	138
Dutt, S. .. .. .	265	Janardan Rao, Y. .. .. .	490
Dwivedi, Rama Shankar .. .. .	496	Jaya G. Iyer (Miss) .. .. .	89, 220, 408
FAROOQ, M. O. .. .. .	489	Jayamma, H. R. (Shrimati) .. .. .	170
Fradkin, M. .. .. .	195	Jayaraman, A. .. .. .	41, 117
Francis, K. J. .. .. .	138	J. C. D. (Rev.) .. .. .	413
Freitas, Yvonne, M. .. .. .	171	Jhingran, V. G. .. .. .	181
GANGULI, R. N. .. .. .	179	Joshi, A. B. .. .. .	314
Ganguly, J. (Rev.) .. .. .	188	J. V. B. (Rev.) .. .. .	416
Ganapathi, K. (Rev.) .. .. .	272	KABADI, M. B. .. .. .	337, 439
Ganapati, P. N. .. .. .	57, 349, 394, 396	Kailasam, L. N. .. .. .	433, 476
Garga, R. P. .. .. .	493	Kalyanam, N. P. .. .. .	305
George, J. C. .. .. .	172	Kandula Pampapathi Rao .. .. .	99
George, Joseph .. .. .	22	Kantam, S. K. .. .. .	338
Ghosh, A. .. .. .	401	Kappanna, A. N. .. .. .	18
Ghosh, A. K. .. .. .	402	Kapur, S. L. .. .. .	245
Ghosh, S. S. .. .. .	136, 359	Karamchandani, S. J. .. .. .	55
— (Rev.) .. .. .	109	Kempanna, C. .. .. .	181
Ghosh, T. .. .. .	67	Khambata, S. R. .. .. .	253
Giri, K. V. (Rev.) .. .. .	35, 223	Khandelwal, D. P. .. .. .	242
Gopala Aiyar, K. V. .. .. .	218	Khan, M. Q. .. .. .	89
Gopalachari, N. C. .. .. .	212	Khan, N. H. .. .. .	306
Gopalakrishnan, S. .. .. .	29	Khanolkar, D. D. .. .. .	296
Gopala Menon Sreekantath .. .. .	18	K. M. G. (Rev.) .. .. .	223
Gopinathan Nair, G. .. .. .	390	Kohli, R. C. .. .. .	266
Govindan, T. K. .. .. .	451	Konar, R. N. .. .. .	216
Gupta, B. B. .. .. .	219	Krishna Lal .. .. .	136
Gupta, C. M. .. .. .	437	Krishnamurti, K. .. .. .	51
Gupta, S. L. .. .. .	392	Krishnamurty, K. V. .. .. .	397
Gurappa, K. M. .. .. .	442	Krishnamurthi, M. .. .. .	332
HALDANE, J. B. S. (Rev.) .. .. .	460	Krishnamurthy, M. .. .. .	444
Hameedul Hasan .. .. .	489	Krishnamurthy, S. (Rev.) .. .. .	412
Handa, K. L. .. .. .	409	Krishnan, V. R. .. .. .	132
Hariharan, P. (Rev.) .. .. .	270	K. R. K. (Rev.) .. .. .	109
Hariharan, S. (Rev.) .. .. .	361	K. R. (Rev.) .. .. .	224, 273, 462
Hearmon, R. F. S. .. .. .	10	Krishnaswami, S. .. .. .	351
INAMDAR, A. R. .. .. .	170	Krishna Pillai, V. .. .. .	302
Inderchand Baid .. .. .	58	Krishna Sastry, K. S. .. .. .	181
Inderjit Singh (Rev.) .. .. .	112	— (Rev.) .. .. .	319
Indra Sanghi .. .. .	297	K. S. S. (Rev.) .. .. .	73, 150
Israel, P. .. .. .	309	K. S. V. (Rev.) .. .. .	33, 269
Iswaran, V. .. .. .	341, 489	Kulkarni, A. B. .. .. .	254
Iyengar, K. S. .. .. .	436	Kumar, L. S. S. .. .. .	406
JAGANNADHA RAO, K. V. .. .. .	168	— (Rev.) .. .. .	150
Jain, H. K. .. .. .	174	Kunte, N. S. (Mrs.) .. .. .	94
Jaipurkar, M. K. .. .. .	312	Kuppuswamy, S. .. .. .	343
		Kurnosova, L. .. .. .	195
		Kursanov, A. L. .. .. .	87
		K. V. (Rev.) .. .. .	70, 146

	PAGE		PAGE
LA FOND, E. C. . . . .	431	Nagarajan, K. . . . .	390
Lakshmana Rao, M. V. . . . .	396	Nagaraġa Rao, K. R. . . . .	138
Lal, K. C. . . . .	387	Nair, P. P. . . . .	208
Lall, B. S. . . . .	399, 458, 503	Nambudiri, P. N. . . . .	350
Lande, Alfred . . . . .	81	Nanda, K. K. . . . .	141
Lekh Raj Sharma . . . . .	53	Narayanamurti, D. . . . .	22, 97, 266
Levitt, Leonard, S. . . . .	131	Narayana, R. (Rev.) . . . . .	190
Livingston, R. L. . . . .	330	Nargund, K. S. . . . .	170
Loyal, D. S. . . . .	357	Narasimha Rao, M. V. . . . .	395
L. S. R. (Rev.) . . . . .	273	Narayan, T. K. . . . .	302
MADHAVAN NAIR, S. . . . .	172	Natarajan, C. V. (Rev.) . . . . .	73
Madhava Rao, B. S. (Rev.) . . . . .	186	Natarajan, K. V. . . . .	454
Magar, N. G. . . . .	208	Natarajan, R. . . . .	312
Mahadeva Iyer, K. . . . .	266	Natarajan, S. . . . .	210
Mahendra Kumar . . . . .	486	Nebe, W. . . . .	430
Malhotra, C. P. . . . .	351	Neelakantam, K. . . . .	482
Malhotra, S. K. . . . .	27	Negi, B. S. . . . .	359
Mallikarjunan, R. . . . .	299, 334	Negi, L. S. . . . .	213
Mandal, S. C. . . . .	458	Ninan, C. A. . . . .	60
Meena Rao, J. . . . .	343	Nirmala Chatterjee . . . . .	98
Mehendale, D. D. . . . .	351	Noronha, H. D. (Rev.) . . . . .	510
Menon, A. G. K. . . . .	450	N. V. (Rev.) . . . . .	72
Menon, C. C. . . . .	245	РАБРАТ, ПАРАМУТ, R. . . . .	163
Menon, M. G. K. (Rev.) . . . . .	233	Pal, N. L. . . . .	212
— (Rev.) . . . . .	507	Pandala, K. R. . . . .	173
Merchant, J. R. . . . .	441	Pandit, A. L. . . . .	254
Merh, J. L. . . . .	96	Pandya, N. S. . . . .	437
Mishra, D. . . . .	356	Pandya, J. R. . . . .	437
Misra, G. . . . .	64, 356	Pant, D. D. . . . .	242
Misra, J. N. . . . .	343	Pantulu, J. V. . . . .	497
Misra, R. (Rev.) . . . . .	74	Paramasiviah, C. . . . .	346
Mital, S. P. . . . .	314	Parthasarathi, K. . . . .	218, 257
Mitra, S. N. . . . .	221, 512	Patel, A. J. . . . .	258
M. J. N. (Rev.) . . . . .	151	Patel, M. K. . . . .	258, 494
Moghe, S. S. . . . .	410	Patel, R. M. . . . .	410
Mohammad Ali, S. . . . .	178	Patel, R. P. . . . .	140
Mohan Rai . . . . .	443	Patil, J. A. . . . .	358, 404
Mohanty, N. N. . . . .	492	Patnaik, D. . . . .	243, 292
Moniz, I. . . . .	494	Perti, S. L. . . . .	343
Motwani, M. P. . . . .	55	Pillay, P. P. . . . .	266
Moudgal . . . . .	483	Prasad, A. R. . . . .	178
M. S. S. (Rev.) . . . . .	316	Prasada Rao, R. . . . .	431
Mukerji, B. (Rev.) . . . . .	508	Prasad, B. N. . . . .	25
Mukherji, A. . . . .	210	Prora, Murgar . . . . .	105
Mukherji, N. . . . .	67	P. R. P. . . . .	129
Murthy, D. V. . . . .	89	Puri, V. (Rev.) . . . . .	417
Murty, M. S. . . . .	347	Pushkarnath . . . . .	214
Murty, Y. S. N. . . . .	161	RADHAKRISHNA, S. (Rev.) . . . . .	459
Muthukrishnan, T. S. . . . .	138	Radhakrishnan, T. (Rev.) . . . . .	459
NAFDE, W. G. . . . .	167	Radhey Shyam . . . . .	491
Nagabhushanam, R. . . . .	394	Raghava Rao, Bh. S. V. . . . .	167
Nagarajan, S. S. . . . .	29	Raghayan, R. V. . . . .	338
		Raghupathy, E. . . . .	483

	PAGE		PAGE
Raghu Prasad, R. . . . .	302	Sampath, S. (Rev.) . . . . .	335
Raina, P. N. . . . .	487	Sandbhor, N. V. . . . .	358
Rai, P. . . . .	456	Santappa, M. (Rev.) . . . . .	70
Rajagopalan, K. S. . . . .	387	Sarada Subrahmanyam . . . . .	15
Raja, N. . . . .	300	Saraswathy Royan (Miss) . . . . .	400
Ramabhadran, G. . . . .	100	Sardesai, Kashinath, S. . . . .	209
Ramachandran, J. . . . .	474	Sarma, P. S. . . . .	483
Ramachandran Nair, P. V. . . . .	302	-- (Rev.) . . . . .	317
Ramachandran, V. . . . .	299	Sarma, T. P. . . . .	167
Ramachandra Rao, C. N. . . . .	330, 474	Sarojani Damodaran, A. P. (Miss) . . . . .	176
Ramachandra Rao, H. N. (Rev.) . . . . .	506	Satyanarayana, R. . . . .	296
Ramachandra Rao, L. . . . .	168	Satyanarayan, Y. . . . .	69, 220
Ramaiah, N. A. . . . .	246, 392	Satya Ranjan Sarkar . . . . .	252
Ramakrishna, B. S. . . . .	376	Saxena, R. S. . . . .	437
-- (Rev.) . . . . .	363	Sayeeduddin, M. . . . .	402
Ramakrishnan, C. V. . . . .	485, 487	Scaria, K. S. . . . .	172
Ramakrishnan, T. (Rev.) . . . . .	318, 509	Sehra, K. B. . . . .	163
Ramamurti, K. . . . .	130	Sen, C. . . . .	446
Ramanathan, K. G. . . . .	95	Sen, D. . . . .	94
Raman, Sir C. V. . . . .	371, 421	Sengupta, P. N. . . . .	221, 512
Raman, P. S. . . . .	22	Sen, P. . . . .	132, 135
Ramanujan, R. A. . . . .	255	Seshachar, B. R. (Rev.) . . . . .	415
Rama Rao, R. . . . .	390	Seshadri, T. R. . . . .	123
Ramaseshan, S. (Rev.) . . . . .	460	Seshagiri Rao, T. . . . .	332
Ramaswamy, A. S. . . . .	390	Seshappa, G. . . . .	262
Rama Swamy, S. (Rev.) . . . . .	411	Seth, B. R. (Rev.) . . . . .	361
Ramiah, K. . . . .	340	Seth, Roshan Lal . . . . .	244
Ramiah, N. . . . .	402	Shama Rao, H. K. . . . .	406
Ramji Sharma . . . . .	410, 500	Sharan, R. K. . . . .	264
Ram Udar . . . . .	23	Sharma, B. B. . . . .	304
Ranganathan, K. S. (Rev.) . . . . .	37, 75	Sharma, B. K. . . . .	512
Ranganathan, S. K. . . . .	343	Sharma, O. P. . . . .	96
Rangaswami, G. . . . .	30, 176	Shearer, J. . . . .	198
Rane, A. T. . . . .	439	Shetty, B. V. . . . .	358
Rao, C. R. (Rev.) . . . . .	315	Shinde, P. A. . . . .	499
Rao, G. S. . . . .	340	Siddappa, G. S. . . . .	300
Rao, K. S. K. . . . .	213	Singh, D. D. . . . .	53
Rashmi J. Shah (Miss) . . . . .	441	Singh, K. P. . . . .	261
Rawat, V. S. . . . .	445	Singh, L. B. . . . .	211
Ray Chaudhuri, D. N. . . . .	402	Singh, M. P. . . . .	63
Richardson, E. G. . . . .	155	Singh, R. N. . . . .	161
R. K. M. (Rev.) . . . . .	363	Singh, S. N. . . . .	54, 143, 211
R. N. (Rev.) . . . . .	110	Singh, V. B. . . . .	23
Roy, B. R. . . . .	221	Sirsi, M. . . . .	390
Roy Choudhary, B. N. . . . .	214	-- (Rev.) . . . . .	149, 364, 417
Roy, R. P. . . . .	312	Sitanath Das . . . . .	260
SACHAR, R. C. . . . .	104, 105	Sivarama Sastry, G. . . . .	332
Sadasivan, T. S. . . . .	49, 165	S. N. D. G. (Rev.) . . . . .	225
Sadgopal (Rev.) . . . . .	365	Somasekhara, S. . . . .	474
Sahay, J. N. . . . .	247	Sowmini Rajagopalan, C. K. . . . .	30
Sahni, S. L. . . . .	264	S. R. (Rev.) . . . . .	34, 74
Sahoo, B. . . . .	243, 292	S. R. (Rev.) . . . . .	222, 316
Sahu, G. . . . .	64	S. R. K. (Rev.) . . . . .	462
Sambhu Lall Basak . . . . .	101	S. R. R. (Rev.) . . . . .	34
		Sreenivasan, A. . . . .	202

	PAGE		PAGE
Sreeramulu, C. .. .. .	59	Tiwari, M. .. .. .	503
Sreeramulu, T. .. .. .	61	Tonapi, G. T. .. .. .	133, 184, 352
Srinivasan, K. V. .. .. .	180	T. R. G. (Rev.) .. .. .	71, 412, 413
Srinivasan, M. .. .. .	343	Trivedi, P. L. .. .. .	20
Srinivasan, R. .. .. .	46	VAGHANI, D. D. (Miss) .. .. .	388
Srinivasan, V. R. .. .. .	340	Vaidyanadhan, R. .. .. .	54
Srivastava, B. K. .. .. .	503	Varadarajan, P. D. .. .. .	448
Srivastava, J. S. .. .. .	456	Varma, P. M. .. .. .	302
Srivastava, P. N. .. .. .	144	Varshney, I. P. .. .. .	489
Stoicheff, B. P. .. .. .	1	Vasudevamurthy, A. R. .. .. .	389
Subba Rao, D. V. .. .. .	349	Vasudevan, C. K. .. .. .	31
Subir Sen .. .. .	65	Vasudeva, R. S. (Rev.) .. .. .	511
Subodh Kumar Roy .. .. .	134	Veda Moorthy, G. .. .. .	309
Subrahmanyan, V. .. .. .	343	Veeriah, K. .. .. .	298
Subramaniam, M. K. .. .. .	112	Velankar, N. K. .. .. .	451
— (Rev.) .. .. .	274, 318, 364	Venkatachalam, K. A. .. .. .	337
Subramanian, T. R. .. .. .	138, 214	Venkataraman, G. S. .. .. .	306, 355, 454
Sundaralingam, V. S. .. .. .	138	Venkataraman, K. N. .. .. .	389
Sundara Raghavan, R. .. .. .	448	Venkatasubba Rao, S. R. .. .. .	303
Sunthakar, S. V. .. .. .	209	Venkatasubramanian, N. .. .. .	438
Suryanarayana Murty, Y. .. .. .	168	Venkateswarlu, P. .. .. .	296
Suryanarayanan, S. .. .. .	447	Venkateswarlu, V. .. .. .	482
Susil Kumar Kor .. .. .	94, 339	Vorghese, C. A. .. .. .	18
Swaminathan, M. S. .. .. .	63	Verma, S. C. .. .. .	177
TALATY, E. R. .. .. .	18	Vijayakrishnan, K. P. .. .. .	350
Tandon, S. L. .. .. .	405, 407	Vijayasaradhy, M. .. .. .	218, 257
Taneja, G. C. .. .. .	495	Vishnu .. .. .	246
Tembe, V. P. .. .. .	351	Vishnu Swarup .. .. .	314
Tendolkar, G. S. .. .. .	338	Vishwa Paul .. .. .	409
Thakar, C. V. .. .. .	457	V. N. K. .. .. .	480
Thakor, V. M. .. .. .	388	V. P. R. (Rev.) .. .. .	226
Thanawalla, C. B. .. .. .	20	V. R. K. (Rev.) .. .. .	113, 414
Thombre, M. V. .. .. .	498	WEINGAERTNER, E. (Rev.) .. .. .	461
Thosar, B. V. .. .. .	281	Wolfe, Peter, E. .. .. .	283, 300
— (Rev.) .. .. .	269	YODU, G. B. .. .. .	294
Thyagarajan, T. R. .. .. .	28		
Tiruvenkatachar, V. R. .. .. .	327		

## Subject Index

	PAGE		PAGE
ABNORMAL Pollen Tube Development in a <i>Nicotiana</i> Hybrid .. .. .	397	Advances in Protein Chemistry, Vol. XI (Rev.) .. .. .	318
Acetyl CoA Deacylase, Detection in Citric Acid in <i>A. niger</i> .. .. .	487	Agriculture and Animal Husbandry in India (Rev.) .. .. .	462
Advances in Carbohydrate Chemistry, Vol. XI (Rev.) .. .. .	71	Aircraft Hydraulics (Rev.) .. .. .	459
— in Enzymology, Vol. XIX (Rev.) .. .. .	317	Airphoto Geology, Advances in .. .. .	283
— in Food Research, Vol. VII (Rev.) .. .. .	71	Air Spora, Effect of Mowing Grass on Constituents of .. .. .	61
— in Nuclear Engineering, Vol. I, II (Rev.) .. .. .	108, 147	Akinete Formation in <i>Horridium</i> (Kutz.) .. .. .	201
— in Pest Control Research, Vol. I (Rev.) .. .. .	228	Albomycin of Grisein .. .. .	275
		Alga <i>Corynomorpha prismatica</i> .. .. .	307



	PAGE		PAGE
Algae, Food and Oxygen from ..	465	Blood Meals of Indian <i>Culicoides</i> ..	132
All-India Congress of Zoology, 1958 ..	116	— Sugar, Determination of ..	486
$\alpha$ -Keto Acids, Studies in the Reactions of	441	Bonding of Bone Fracture with Plastics	322
Alternate Host Plants of <i>Chilo zonellus</i>		Books Received 37, 75, 114, 152, 190, 227,	
Swinhoe ..	405	274, 320, 366, 418, 463, 511	
Aluminum Soldering Simplified ..	115	Boric Acid, Fluorescence Reaction for	
<i>Anchoviella insulana</i> , Occurrence of ..	265	Detection of ..	482
Annual Review of Biochemistry,		Boron Rocket Fuels ..	314
Vol. XXVI (Rev.) ..	111	Botulism ..	78
Anodic Reactions in the Electrolysis of		British Association for the Advancement	
Acid-Cobalt-Fluoride ..	18	of Science ..	91
Anomalous Transmission of X-rays by		CAMERA that Locates Radioactivity ..	229
Single Crystal Germanium ..	331	Cancer Research, Salk's Contribution to	276
<i>Anomis sabulifera</i> Guenther, Effect of		<i>Carapa</i> Spp., Occurrence of, in Peat Bed	
Insecticides on the Larvæ of ..	179	near Calcutta ..	359
Antarctica is a Continent ..	192	Carbon ( $^{12}\text{C}$ ) as Reference Nuclide ..	385
Antheridium in Characeæ ..	138	Cardiac Studies ..	38
Antibiotic Annual, 1957-58 (Rev.) ..	272	Carl Zeiss Jena ..	430
— in Whaling Industry ..	276	Carmine ..	323
Anticline, Southerly Pitching, near		Carnegie Institution of Washington, Year-	
Doddaguni ..	442	Book, 1956-57 (Rev.) ..	271
Antidote to Strontium ..	228	Cell Functions, Levels of Organisation in	202
Aphids of Calcutta and Host Plant Families	402	Cellulose Decomposition by Species of	
Archæological Non-Corrosion ..	367	<i>Nocardia</i> ..	171
<i>Aristolochia bracteata</i> Retz., Chemical		<i>Cercospora</i> on <i>Blumea lacera</i> DC. ..	260
Examination of ..	168	Chemical Aeronomy ..	192
Arizona Meteorite Crater ..	326	Aspects of Ecology in Relation to	
<i>Artemia salina</i> , Occurrence of ..	58	Agriculture (Rev.) ..	511
Ascorbic Acid in Germinating Seeds of		— Control of the Rice Stem-Borer ..	89
<i>Sesbania grandiflora</i> Pers. ..	343	(Chemistry and Biology of Yeasts (Rev.)	318
Asexual Reproduction in <i>Characiosiphon</i>		— of Co-ordination Compounds, Symposium	
<i>rivularis</i> ..	500	— of Natural Products (Rev.) ..	412
Astronomers' Congress ..	230	Chemotherapy in Bacterial and Viral	
Atlas of Air-borne Pollen Grains (Rev.)	417	Infections, Symposium ..	480
— of the Skies, The New ..	325	'Chimera' in Tur ( <i>Cajanus cajan</i> Millsp.)	358
Atomic Radiation Dangers (Rev.) ..	411	Chromocenters and Nucleolar Equivalents	
— Reactor for India ..	228	in the Yeast Nucleus ..	400
<i>Attacus ricini</i> , Cuticle of ..	264	Chromosomal Interchange in Pearl Millet	497
Award of Research Degrees 79, 193, 277,		Chromosome Number in <i>Chlorophytum</i>	
323, 420, 467, 516		<i>tuberosum</i> , Baker ..	406
Azaserine II ..	116	— in <i>Iberis umbellata</i> L. ..	405
BACTERIAL Blight of <i>C. tetragonoloba</i> ..	258	— of Dicotyledons ..	140
— Diseases of Plants from Bombay State,	494	— of Pulmonate Snails, <i>Cryptozona</i>	
— Leaf-Spot of <i>Pennisetum typhoides</i> ..	30	<i>Morch</i> ..	311
Bacteriological Study of Toned Milk ..	252	— of Two Common Weeds ..	367
Barbiturates, Aggregation of ..	132	— of <i>Vitaceæ</i> ..	358
BHC Resistance in <i>Musca nebulosa</i> ..	306	Clay Mineral Studies ..	198
Biological Replications of Macromolecules (Rev.) ..	460	Cleaning of Glass by Ionic Bombardment	321
Birbal Sahni Institute of Palæobotany	420	<i>Clupisoma garua</i> , Feeding Habits of ..	55
Birefringence, Stress and Wavelength		Cobalt and Zinc Contents of Forage	
Dependence ..	436	Plants ..	220
Blight of Sesame Caused by <i>Alternaria</i>		Cobalt-60 to Convert Coal to Gas ..	473
<i>sesami</i> ..	492		

	PAGE		PAGE
Coccinellid Beetles of Banyan Trees in Bihar	351	Dietary Requirements of the Hide Beetle	399
Coffee Leaf-Miner, <i>Agromyza</i> ( <i>Melanagromyza</i> )	31	Discovery Reports - Sperm Whales of the Azores ( <i>Rev.</i> )	225
Colchicine-induced Polyploids of <i>Alyssum maritimum</i> Lam.	407	Disinfectants, Their Values and Uses ( <i>Rev.</i> )	413
Cold Vaccine	38	Dislocations, Decoration of	336
<i>Coleus parviflorus</i> Benth.	448	Double Bond Reactivity of Unsaturated Fatty Acids	299
Common Medicinal Plants of Darjeeling ( <i>Rev.</i> )	74	Dry Battery Receivers with Miniature Valves ( <i>Rev.</i> )	188
Comparative Physiology of Nervous Control of Muscular Contraction ( <i>Rev.</i> )	112	EARTH'S Structure, Geochemical Hypothesis	50
Compressional Velocities in Indian Rocks	251	Earthworms, Influence of, on Structure of Soils	213
Conductometric Studies on Copper Tungstates	437	Economic and Social Consequences of Automation ( <i>Rev.</i> )	110
Conservation of Parity Law on Free Neutrons	85	Effect of Cortisone on the Concentration of Alkaline Phosphates in Uropygial Gland	401
Contact Stresses	368	— of Thyroxine on Phosphatase, etc., in Blood and Milk of Cow	102
<i>Coriandrum sativum</i> , Chemical Investigation of	388	Electrical Gas Discharges ( <i>Rev.</i> )	110
Corrosion and Chemistry	153	— Resistivity by Ballistic Method	95
Cortisone, Effect of, an Alkaline Phosphatase	401	Electricity, Second Course of ( <i>Rev.</i> )	34
Cosmetics: Science and Technology ( <i>Rev.</i> )	365	Electrodeposition of Metal Finishing	39
Cosmic Rays, Studies of, with Earth Satellites	195	Electrolytic Etching of Tantalum	297
Cosmology	279	Electromagnetic Weighing	418
Cotton Seeds and Its By-Products, Symposium	323	Electron Exchange Resins—Organic Intermediates	515
Crystal Physics, Recent Soviet Work on — Structures ( <i>Rev.</i> )	10 187	Electronic Device for Assessing Uranium Ore	513
— Structure of <i>L. tyrosine</i> Hydrobromide	46	Electron Phase Microscope	368
Cutworm Pest of Potato in Rajasthan	503	Electro-Refining Nickel, New Process	367
<i>Cycadopteris</i> sp. from Bihar	312	Electrophysiology of the Heart ( <i>Rev.</i> )	150
<i>Cylindrospermum</i> ( <i>C. sphaerica</i> ), Effect of Molybdenum on	306	Elementary Particles, Masses of	131
Cytochemical Studies on the Termite Queen	56	<i>Emblica officinalis</i> , Gaertn, Chemical Examination of	266
Cytogenetic Studies in Indian Silkworms	457	Embryology of <i>Aerva tomentosa</i> Forsk.	105
Cytological Studies in <i>Fissideus elimbatus</i>	312	Encyclopedia of Chemical Technology ( <i>Rev.</i> )	271
— — on Spermatogenesis of <i>Eyprepocnemis</i> sp.	98	End of a Wave	431
Cytology of <i>Diplaziopsis javanica</i>	146	Energetics in Biochemical Reactions ( <i>Rev.</i> )	411
— of Fern Genus <i>Acrophorus</i>	177	Entomogenous Fungus, Studies in	99
— of <i>Isætes</i>	60	Enzymic Browning in Apple	300
— of Two Species of Salviniaeae	357	Ergot of <i>Bajri</i> in Bombay State	499
Cytoplasmic Male Sterility in <i>Psyllium</i>	268	Estimation of Calcium in Sugarcane Juices	246
— — — in Jowar	314	Etching of Fluorite	437
DACTYLOGYRIDS, Head Organ Patterns in Darwinism through Hundred Years	449 233	Evolution by Natural Selection ( <i>Rev.</i> )	507
Darwin Reader ( <i>Rev.</i> )	112	Explorer IV, for Study of Cosmic Radiation	481
<i>Datura innoxia</i> Mill., Occurrence of	394	FADING of Radio Waves	296
Dielectric Breakdown Strength of Wood	25	Film Formation, Film Properties and Film Deterioration ( <i>Rev.</i> )	412

	PAGE		PAGE
Fire-Proofing of Jute .. .. .	93	Grassland and Fodder Resources of India (Rev.) .. .. .	319
Fischer-Tropsch Process .. .. .	237	Green Jassid— <i>Empoasca</i> Sp.—on <i>Sesbania speciosa</i> L. .. .. .	410
Five Million Atmosphere Pressure .. .. .	465	Growth Checks in the Scales of Mackerel .. .. .	262
Flame Photometry (Rev.) .. .. .	362	— of Spirals on Electrodeposited Silver .. .. .	167
Flight Muscles of Birds, Structure and Physiology .. .. .	172	Guided Weapons (Rev.) .. .. .	411
Fluorescence of Spectra of Uranyl Acetate Solutions .. .. .	242	HÆMOGLOBIN Components, Separation of .. .. .	20
<i>Formica fusca</i> L., Respiratory System of Queen of .. .. .	352	Haffkine Institute .. .. .	280
Foundry Materials, Testing and Standardisation .. .. .	369, 435	Harvey Lectures, 1955-56 (Rev.) .. .. .	149
Fourier Analysis and Generalised Functions (Rev.) .. .. .	363	Heat of Wetting of Charcoal .. .. .	53
Free Radicals in Cigarette Smoke .. .. .	207	Heavy Minerals in the Cauvery River Sands .. .. .	346
French Electronic Invention .. .. .	77	Helium from Gas Mixtures .. .. .	368
Fructose-Glucose Relation in Sugarcane .. .. .	257	Helminth Parasites of Donkey .. .. .	456
Fundamental Constants of Physics (Rev.) .. .. .	269	Hepatic Flora of Mt. Abu .. .. .	259
—s of Chromatography (Rev.) .. .. .	70	High Energy Nuclear Physics, Conference .. .. .	230, 294
—s of Immunology (Rev.) .. .. .	72	— — — — (Rev.) .. .. .	269
Fungistatic and Fungicidal Action of Mycostatin .. .. .	176	— Resolution Raman Spectroscopy .. .. .	1
Fungus Diseases in India, Symposium 323 .. .. .	467,	Homology of Pappus' in Trichome Distribution .. .. .	402
		How Television Works (Rev.) .. .. .	507
		<i>Hymenia fascialis</i> C., Pest of Sugarbeet .. .. .	182
		Hybridization between <i>Mucuna pruriens</i> DC. and <i>Mucuna cochinchensis</i> A Chev. .. .. .	468
GAFFKYA Species from Indian Earthworm .. .. .	253	ICE-STORED Prawns, Free Amino Nitrogen Content as an Index .. .. .	451
Garcenia Leaves, Condensing Enzyme in .. .. .	485	Important Discovery on Nucleons .. .. .	419
<i>Garra ethelwynnae</i> , Cyprinid Fish from Eritrea .. .. .	450	Inactivation of <i>Azotobacter</i> by Heat .. .. .	341
General Microbiology (Rev.) .. .. .	416	Indian Academy of Sciences .. .. .	9
Genetics and Plant Breeding in South Asia (Rev.) .. .. .	510	— Aspergilli, Addition to .. .. .	496
Geochemical Survey Techniques .. .. .	197	— Botanical Society .. .. .	79
Geodesy and Geophysics, International Union of .. .. .	13	— Institute of Science, Bangalore, Golden Jubilee .. .. .	375
Geological, Mining and Metallurgical Society .. .. .	323	— Science Congress .. .. .	45
Geological Society of India .. .. .	323	— Society of Genetics and Plant Breeding .. .. .	79
Geology of Adikmet Area .. .. .	300	— Solanum Species .. .. .	409
Geophysical Exploration in the Coastal Belt of Madras State .. .. .	476	Industrial Research at General Electric (Rev.) .. .. .	335
Geophysical Rocket .. .. .	229	Information Theory and Applications .. .. .	376
Geothermal Power .. .. .	386	Inheritance of Tiny-Leaved and Alternifolia Forms in <i>Ciccr arietinum</i> L. .. .. .	183
Germanium as a Catalyst .. .. .	515	Inheritance Study in Wheat .. .. .	404
— Thermometers .. .. .	514	Insdoc Report, 1957-58 .. .. .	516
Germination of Tobacco Seeds .. .. .	212	Insect Flight (Rev.) .. .. .	189
Gibberellic Acid and Plant Growth .. .. .	276	— Incidence and Branching in Rice .. .. .	309
Glossary of Indian Medicinal Plants (Rev.) .. .. .	75	Institution of Chemists (India) .. .. .	79, 369
Glutamic Acid Decarboxylase in <i>Fusaria Goniozus</i> Sp. Parasite of Stem and Root-borers of Sugarcane .. .. .	210	Instrumentation for Gas Chromatography .. .. .	76
		International Botanical Congress .. .. .	420
<i>Gradusia chapra</i> , Alimentary Canal of .. .. .	144	— Congress of Industrial Chemistry .. .. .	277
Granite-Pakhal Relationship .. .. .	490	Introduction to Enzymology (Rev.) .. .. .	509

	PAGE		PAGE
Introductory Nuclear Physics (Rev.) ..	222	Mango Necrosis, Prevention of ..	446
Invertebrate (Rev.) ..	273	Marine Biological Station, Porto Novo ..	48
Iodine Content of Indian Fodder Plants	408	Marker Gene for Red Gram ..	100
Ion-Exchange, Recent Developments in ..	232	Maser, Quantum Hyper-Frequency Amplifier ..	117
Ionospheric Behaviour at 10 Metres Wavelength, Abnormal ..	332	Measurement of Colour (Rev.) ..	270
Iron and Steel Industry in India, Symposium ..	466	Mechanics of Real Fluids, Symposium ..	78
Isochromene, Synthesis of ..	342	Melting of Metals in a State of Contactless Suspension ..	192
Isœtes in Madhya Pradesh, Occurrence of	410	Methionine, Role of, in Malaria ..	390
Isopropyl-Noradrenaline in Human Urine	15	Methods of Biochemical Analysis, Vol. V (Rev.) ..	223
Isothiocyanates, Absorption Spectra of Organic ..	474	— of Enzymology, Vol. III (Rev.) ..	35
JAK WEEVIL, Occurrence and Life-Cycle of	214	Microtron ..	268
KINETIC Studies in Chromic Acid Oxidations ..	438	Microwave Absorption in Solids ..	41
Kinetochore Problem in Hemiptera ..	303	— Chemistry ..	514
Kit for Detection of Ghee Adulteration	420	Milk Yield and Udder Conformation, Selection of Buffaloes for ..	495
Kostanecki-Robinson Phenylacetylation of Orcacetophenone ..	20	Million Degrees Temperatures, How Measured ..	274
Krypton-85 and Diagnosis of Heart Disease ..	322	Molybdenum Content of Forage Plants ..	69
LABORATORY Manual of Batch Distillation (Rev.) ..	109	— Requirement of <i>Selenastrum westii</i>	454
Lady Tata Memorial Trust Scholarships 39,	230	Monazite in the Charnockites of Visakhapatnam ..	347
<i>Lagenaria siceraria</i> Standl., Teratological Phenomenon in ..	211	Monsoons of the World, Symposium ..	129
<i>Lantana camara</i> L., Visits of Insects to Flowers of ..	452	Morphology of Ovule of <i>Zephyranthes citrina</i> Baker ..	501
Lattice Parameters of Hexagonal Cobalt	51	Mosaic Disease of Brinjal ..	302
Leaf Heteromorphism in <i>Sesumum indicum</i> L. ..	32	Moulds, Metabolites and Tissues ..	49
Leaf-Spot Disease of <i>Echinochloa colomum</i> Link. ..	96	<i>Mugil cephalus</i> Linnaeus, Seaward Migration of ..	181
Lectures in Immunochemistry ..	417	Mulching of Vegetables (Rev.) ..	273
Leukemias (Rev.) ..	414	Mustard Oil, Detection of, in Edible Oils	221
Life of Satellites ..	473	— as Adulterant, Detection of ..	512
Lightning Shock ..	12	NANGAL Heavy Water Plant ..	513
Lipid Depleted Adrenal Cortex in Molybdenum Fed Rats ..	208	Naphthalene as Deterrants for Snakes ..	512
—s, Their Chemistry and Biochemistry (Rev.) ..	188	National Institute of Sciences of India ..	79
Lipoprotein Cholesterol in Coronary Disease and Anæmia ..	163	Nature of Coal, Symposium ..	467
Lithium Developments ..	333	'Network' in Mammalian Neurones ..	27
Living Polymers ..	78	Neutron Cross Sections (Rev.) ..	223
Lobed Leaf-Mutant in Blackgram ..	191	Neurosecretory Cells of the Brain of <i>Hirudinaria granulosa</i> (Sav.) ..	350
Looking at Chromosomes (Rev.) ..	274	New Fossils from Madhya Pradesh ..	76
Low Temperature Physics Conference ..	116	— High Temperature Alloy ..	369
Lysine Supplemented White Rice ..	154	— Method of Analysing Cardiac Functions ..	77
Max Planck (Anniversary) ..	121	— Radio Communications System ..	78
MAGNETISM and Molecular Structure ..	296	— Stage in the Development of Astronomy ..	419
Magnetism (Rev.) ..	317	— Standard of Length ..	153
Male Sterility in <i>Crotalaria striata</i> ..	181	— Superconductors ..	432
Maleic Hydrazide, Effects of, on Rice ..	64	— Type of Reflexes ..	122
		<i>Nicotiana</i> Hybrid, Abnormal Pollen Tube in ..	397
		Nitrogen Content and Yield of Sugarcane Varieties ..	393
		— Fixation in <i>Azotobacter chroococcum</i>	489
		Effect of Humus on ..	489

	PAGE		PAGE
Nitrogen in Host Susceptibility to <i>Piricularia oryzae</i> Cav., Role of ..	447	Perspectives in Organic Chemistry (Rev.)	71
Nitroparaffins as Substitute for Petrol ..	515	Petal Number, Regulation of ..	134
Nobelium, Preparation of ..	14	Petrological Investigations of the Rocks of Mohaud ..	168
Nobel Prize Awards for 1958 ..	427	<i>P. gallinaceum</i> in Chick Malaria ..	390
Nomenclature of Cell Strains ..	322	Pharmacognosy of Ayurvedic Drugs (Rev.) ..	37
Non-Ferrous Metallurgy ..	116	Phenazines (Rev.) ..	148
Nor-Pongamol from Pongamol ..	482	Phenolic Content of Sugarcane and Spontaneum Juices ..	218
<i>Notothylas indica</i> Kashyap, Patterns of Regeneration in ..	23	Photochemical Properties of Ni-Compounds ..	298
Nucleic Acids, The Chemistry of ..	123	Photolysis of Uranyl Oxalate ..	292
Nuclear Differentiation in Binucleate Pollen Mother Cells ..	174	Physical Conditions in Space ..	231
— Fuel Cycles, Symposium ..	466	Physiology and Pathology of the Kidney (Rev.) ..	73
— Spectroscopy ..	281	Phytoplankton Production, Dredging and Pillow Structures, in Ramagiri Schist Belt ..	444
OBITUARY: Prof. M. Damodaran ..	130	<i>Pinus roxburghii</i> Sar., Effect of IAA and Kinetin on Pollen Tubes of ..	216
— Prof. K. V. Giri ..	295	"Pioneer" Used as Repeater Station ..	464
— Dr. K. C. Pandya ..	435	Plant Chromosome Numbers, Index to — Growth-Regulating Activity of IMSA ..	275
— Prof. W. Pauli ..	481	— Physiology, Indian Society for ..	193
Occurrence and Inheritance of Telescopic Leaf-Sheaths in Sorghum ..	59	— Virus Serology (Rev.) ..	151
Oceanographic Congress ..	466	Polarization Studies on Chromate-treated Zinc ..	387
Oedogonium ( <i>Oc. randhawae</i> Sp. Nov.), a New Species ..	355	Polymerisation of Methyl Methacrylate by Hydrazine Hydrate ..	245
Oestrogenic Hormone from Clover ..	228	Polystyrene as Thermal Insulator ..	464
Organic Phosphates, Action of, on Cotton Bug ..	503	Potassium Chloride from Sea Bitterns ..	420
— Production in the Inshore Waters ..	302	Potentiometric Determination, Dissociation of Gallic Acid ..	392
— Tin Compound as a Crop Fungicide ..	368	Practical Guide to Plant Sociology (Rev.) ..	74
Orobanche and Its Hosts, Root Relations	445	<i>Precis orthya</i> Swinhoe, External Anatomy of ..	453
<i>Ortho-Para</i> Catalysis in Liquid-Hydrogen Production ..	286	Pre-Soaking Seed Treatment with 2-Methylbenzimidazole on Rice Seedlings ..	356
<i>Oryza brachyantha</i> A. Cheval et. Roehr., Variation in the Stamen Number ..	354	Preserving Hard Wood with Oxy-Welding Pressure Measurement in Vacuum Systems (Rev.) ..	361
Ovaries of <i>Linaria maroccana</i> Hook., Growth of ..	104	Prevention of Moss Growth in Concrete Races ..	76
Oxidative Decarboxylation of Alpha-Hydroxy Acids ..	22	<i>Procamallanus baylis</i> , 1923 (Nematoda) ..	348
Oxygen in Steel-Making, Some Applications of ..	334	Proceedings of the Third Weed Control Conference (Rev.) ..	150
PALLISENTIS ( <i>Acanthocephala</i> ), a New Species of the Genus ..	107	Progress in Nuclear Physics, Vol. V (Rev.) ..	147
<i>Parapenaeopsis cornutus</i> , Kishinouye Occurrence of ..	351	Propolis in the Prothoracic Spiracles ..	133
Partial Parthenocarpy in the Genus <i>Luffa</i> ..	54	Proventricular Structure in Cockroach ..	305
Particle Size Distribution by Centrifugal Sedimentation ..	192	Public Health Administration Study Tour in U.S.S.R. ..	467
Parthenogenesis and Polyploidy in <i>Mammalian</i> Development (Rev.) ..	113	Puzzle-Math (Rev.) ..	462
Peaceful Uses of Atomic Energy—Second Geneva Conference ..	230	Pyrethrum ..	275
Pearl Millet, Lateral Bud Development in Pelagic Tunicates as Indicators of Water Movements ..	57	Pyrolysis and Ignition of Wood ..	22
<i>Penitella</i> Sp., a New Pholad ..	394		

	PAGE		PAGE
QUANTUM Chemistry (Rev.) ..	33	Semimicro Qualitative Organic Analysis (Rev.) ..	413
— Physics and Philosophy ..	81	Separation of Sols from Sol-Mixtures ..	51
Quinoline Derivatives, Synthesis of 4-Hydroxy-6-Sulfonamide ..	209	— of Thorium and Uranium by Ion-Exchange ..	94
RADAR with a Memory ..	513	<i>Sesbania grandiflora</i> , Proteins from the Seeds of ..	286
Radiation Effects in Solids (Rev.) ..	316	Sintering of Thoria ..	338
Radioactive Contamination of Food Crops ..	516	Sir Dorabji Tata Gold Medal ..	154
— Sterilization of Insect Pests ..	515	Society of Theoretical and Applied Mechanics ..	86
Radio Bursts from the Sun, Origin of ..	241	Soil Moisture Content ..	39
— Isotopes Training Course ..	277	Solar Energy and the Depth of the Earth ..	115
— Wave Propagation in the Ionosphere ..		— Radio Event ..	129
Polarization Curves for ..	161	Solid State Physics, Vol. III (Rev.) ..	222
Raman Spectroscopy and the Structure of Simple Molecules ..	1	— — —, Vol. IV (Rev.) ..	460
— Spectrum of Pyridine N-oxide ..	340	Solubility Data and Formation of Complex System: AgCNS-NH <sub>3</sub> -H <sub>2</sub> O ..	244
<i>Rauwolfia serpentina</i> , Stem-Root of ..	448	— of Phosphorus Oxychloride-Al. Chloride Complex ..	389
Reactive Intermediates of Organic Chemistry (Rev.) ..	70	Solution Stability of Some Metal Chelates ..	337
Recent Progress in Hormone Research (Rev.) ..	508	Solvents (Rev.) ..	33
Reduction of Thorium at the Dropping Mercury Electrode ..	167	Solvolytic of 1-Phenyl- <i>n</i> -Propyl Chloride ..	390
Relativity and Space-Travel ..	327	Sorel Cement as a Binder ..	443
Resacetophenone Oxime in Spectrophotometry ..	439	South Pole Snow Pit ..	38
Resorcinol as a Reagent for Uranium ..	340	Soviet Education for Science and Technology (Rev.) ..	479
— Dimethyl Ether, Substitution in ..	170	Space-Travel, Relativity and ..	327
Rice in India (Rev.) ..	224	Sparrow as an Enemy of Locust ..	502
Roasting Copper Concentrates ..	76	Species Problem (Rev.) ..	415
Rocket-Firing Contribution to Geophysical Year ..	159	Specific Heat of Wood ..	97
Rolling of Strip, Sheet and Plate (Rev.) ..	187	Spectroscopy, Symposium ..	78
Root Inducing Substance in Groundnut Seeds ..	29	Spermatogonial Chromosomes of Two Lizards ..	504
Root-Knot Nematodes on Potatoes ..	214	Spot Test for Nitrate Ion ..	274
Roots on an Internode in Sugarcane ..	145	Spotted Wilt Disease ..	154
R.W. Coefficient at Different Temperatures ..	210	Spot Variation in <i>Epilachna</i> , Inheritance of ..	458
SAFETY in Coal Mines, New Device for ..	465	Sputniks Experiment with a Dog ..	166
— in Radiology ..	322	Stacking Faults in Closepacked Metallic Lattices, Part I ..	238
— Techniques for Radioactive Tracers ..	270	— — — — —, Part II ..	287
Salinity Tolerance of <i>Ectophasia meculatus</i> ..	99	Starch in Sugarcane, Estimation of ..	218
Sal Wood from Mauryan Pillared Hall ..	136	Statistics for the Social Sciences (Rev.) ..	315
Satellite Anniversary ..	419	<i>Stegana lateralis</i> V.D. Wulp as a Pest ..	138
School Course of Biology (Rev.) ..	190	Sterility in Gram ..	491
Science in Eastern Europe: I ..	371	Stomatal Types in Centrospermae ..	65
— — — —: II ..	421	Storage of Seeds (Rev.) ..	36
Sclerotial Disease of Hollyhock ..	304	Strategy of Chemotherapy (Rev.) ..	364
Scyphistoma Larvæ, Occurrence of ..	396	Streptomycin Dermatitis ..	466
Sector-Visual Method of Electron Diffraction: The Molecular Structure of Tetrachloroethene ..	330	Structure Reports, Vol. XV (Rev.) ..	315
Seed Content and Fruit Shape in Relation to Removal of Stigma ..	143	<i>Stylonychia pustulata</i> , Mating Types, in Subcommissural Organ in Garden Lizard ..	173
Seismic Exploration for Oil in Cambay ..	433	Sugar Constituents of Proceranin, Saponin Sulfonamides, <i>Annals of N.Y. Acad. Sci.</i> (Rev.) ..	112
		— Second Conference (Rev.) ..	224

	PAGE		PAGE
Sulfonyl Ureas and Related Compounds.		Transuranic Elements	419
Effects of in Diabetes (Rev.)	36	<sup>12</sup> C as Reference Nuclide	385
Sulfur: A Possible Metallic Form	367	Twistor	201
Sunflash Screened	464	ULTRASONIC Absorption Measurements	339
Super-High Pressures	418	—s in Electroplating	78
— Powerful Microscope	191	— Velocity in Solids	387
Symposium of Anesthesiology (Rev.)	73	— Vibrations, Applications of	155
Synchronous Motors and Condensers (Rev.)	306	Ultraviolet Colour-Translating Microscope	191
Synthesis of Tetrahydro Naphthacene	254	Uranium (IV) Oxyformate, Preparation of	243
Synthetic Diamonds	228	— Thorium and Rare Earths, Separation of	229
— Geraniol	77	Using Free Radicals	157
TECHNIQUE for Isolating Pathogenic Cultures of <i>Pythium</i> from Soil	180	U. S. Atlas Missile	480
—s for Measuring Protein	115	VACUOLE and the Nucleus of Living Yeast	28
— of Organic Chemistry, Vol. III (Rev.)	461	Variation in the Haploid Chromosome Number of <i>Cochorus sidoides</i>	101
Technology and Academics (Rev.)	506	Vegetable Oils, Symposium	230
Telephony via the Moon	464	Vegetation in Mars	77
Temperature and Salinity Structures of Bay of Bengal	249	Venoms (Rev.)	37
— Dependence of Ultrasonic Absorption	94	Velocity of Light	512
— of 5 Million Degrees	38	Virus Diseases of Plants in Madhya Pradesh	493
Tenebrionid Beetle, Response to Touch Stimuli	219	— Research, Vols. III & IV (Rev.)	165
Terrestrial Magnetic Field and Cosmic Radiation	160	Viscometer, Compensated Moving Cylinder	18
Tetrachloroethene, Molecular Structure of	330	Vitamin A (Rev.)	34
The Mango (Rev.)	225	Volcanic Eruption on Moon	512
Thermoelectric Cooling	369	Volumetric Analysis, Vol. III (Rev.)	109
Thermonuclear Energy	428	WATER Gap of an Unusual Origin	54
— Energy, Controlled Release of	92	— Waves (Rev.)	186
Theoretical and Applied Mechanics, Fourth Congress	420	Weaning Period Prolongation and Weights of Rats	250
— Physics in U. S. A.	469	Wear	322
Three Steps to Victory (Rev.)	316	Weiss Domains, Direct Observation of	321
Thrombinogen, The Properties of	130	Why Liquids Flow	516
Thyroxine and Triiodothyronine, Influence of, in the Rice Moth Larvæ	483	Windscale, Accident at	17
Tip-rot of Mesta	67	World Meteorological Organization to Study Tidal Waves	275
Tissue Homotransplantation Conference <i>Annals, New York Acad. Sci.</i> (Rev.)	113	Wuchurerian Microfilariae in Human Blood	135
Tobacco Beetle <i>Lasioderma serricorne</i> Infestation of Leather by	343	X-RAY Analysis of Rare Earths	191
Tocopherol Content of Ghee	255	— Dangers Greater than Fall-out	465
Toxicity of White Oil	440	— Image Intensifier	275
Tracer Application for Organic Reactions (Rev.)	363	— Induced Somatic Haploidy in Watermelon	63
— Atoms in the Study of Plant Life	87	— Microscopy and Micro-Radiography (Rev.)	459
Tracheal Concentration in the Abdomen of Coleoptera	184	<i>Xyleborus discolor</i> Bland., as a Pest	138
Transactions of the Society of Rheology (Rev.)	361	YEASTS (Rev.)	364
Transistor Thyatron	321	ZIRCONS from Granites of Mysore	96
Transference Number in Barium Thiocyanate and Lead Nitrate	247	— in Nandi Granites	345
		Zoological Nomenclature	39
		— Research in India, Symposium	467







